



BID DOCUMENT

FOR

Design, Supply, Construction, Installation, Testing and Commissioning of 2x25kV AC Electrification, Signalling & Telecommunication, E&M and Associated Works on Design-Build Lump Sum Basis for Dadri-Khurja Section (approximately 47 Route Km of Double Line) of Eastern Dedicated Freight Corridor

SYSTEMS WORKS CONTRACT PACKAGE 105

Issued on: **14.06.2017**

ICB No.: HQ/SYS/EC/D-B/Dadri– Khurja

(Part-1)

**EMPLOYER: DEDICATED FREIGHT CORRIDOR CORPORATION OF INDIA LTD
(A GOVERNMENT OF INDIA ENTERPRISE)**

MINISTRY OF RAILWAYS

COUNTRY: INDIA

Table of Contents

PART 1 – Bidding Procedures

Section I. Instructions to Bidders

Section II. Bid Data Sheet

Section III. Evaluation and Qualification Criteria (Following Prequalification)

Section IV. Bidding Forms

Section V. Eligible countries

PART 2 – Employer’s Requirements

Section VI. Employer’s Requirements

Volume 1: General Specifications

Volume 2: Particular Specifications – 2x25 kV, AC Traction Electrification and Associated Works

Volume 3: Particular Specifications – Signalling Works

Volume 4: Particular Specifications – Telecommunication Works

Volume 5: Particular Specifications – E&M and Associated Works

PART 3 – Conditions of Contract and Contract Forms

Section VII. General Conditions (GC) As per FIDIC Yellow Book 1999-Edition

Section VIII. Particular Conditions

- *Appendix to Tender*

Section IX. Contract Forms

PART 4 – Reference Documents

1. Alignment Plans, Yard Plans and Building Plans
2. Power Supply, Distribution, OHE and SCADA system Schemes & layouts and S&T Drawings
3. DFCC-Environmental Assessment Report for Khurja - Dadri Section
4. Environmental Management Framework(EMF) for EDFC
5. DFCC– Resettlement Action Plan for Khurja- Dadri Section
6. DFCC-SHE Manual
7. Specification for 12000hp locomotive and Tractive effort Curve
8. IR’s Transmission line Network and DFCCIL’s Traction Sub Station (TSS) Connectivity

PART 1

Bidding Procedures

Table of Contents

Section	Description	Page Numbers
Section I.	Instructions to Bidders	3
Section II.	Bid Data Sheet	34
Section III.	Evaluation and Qualification Criteria (Following Prequalification)	44
Section IV.	Bidding Forms	59
Section V.	Eligible countries	167

Section I. Instructions to Bidders

Table of Contents

A.	General.....	3
1.	Scope of Bid.....	3
2.	Source of Funds.....	3
3.	Corrupt Practices	3
4.	Eligible Bidders	5
5.	Eligible Materials, Equipment and Services	7
B.	Contents of Bidding Document	8
6.	Sections of Bidding Document.....	8
7.	Clarification of Bidding Document, Site Visit, Pre-Bid Meeting	9
8.	Amendment of Bidding Document	10
9.	Cost of Bidding	10
10.	Language of Bid	10
C1.	First Stage Technical Proposals: Preparation	11
11.	Documents Comprising the First Stage Technical Proposal.....	11
12.	Letter of First Stage Bid and Attachments.....	11
13.	Alternative Technical Proposals.....	12
14.	Documents Establishing the Eligibility of Materials , Equipment and Services	12
15.	Documents Establishing the Eligibility and Qualifications of the Bidder.....	12
16.	Documents Establishing Conformity of the Materials , Equipment and Services	12
17.	Format and Signing of First Stage Technical Proposal	13
C2.	First Stage Technical Proposals: Submission and Opening.....	14
18.	Submission, Sealing and Marking of First Stage Technical Proposals	14
19.	Deadline for Submission of First Stage Technical Proposals	15
20.	Substitution and Modification of First Stage Technical Proposals	15
21.	Opening of First Stage Technical Proposals by Employer	15
C3.	First Stage Technical Proposals: Evaluation	16
22.	Determination of Responsiveness of First Stage Technical Proposals.....	16
23.	Technical Evaluation of First Stage Technical Proposals	16
24.	Eligibility and Qualification of the Bidder	17
D.	Clarification of First Stage Technical Proposals	17
25.	Clarification Procedures.....	17
26.	Invitation to Submit Second Stage Bids	18
E1.	Second Stage Bid Preparation.....	19
27.	Documents Comprising the Bid	19

28.	Letter of Bid, and Schedules.....	20
29.	Bid Prices and Discounts.....	20
30.	Currencies of Bid and Payment	21
31.	Period of Validity of Bids.....	21
32.	Bid Security	22
33.	Format and Signing of Second Stage Bid.....	24
E2.	Second Stage Bids: Submission and Opening	24
34.	Submission, Sealing and Marking of Second Stage Bids	24
35.	Deadline for Submission of Second Stage Bids	25
36.	Late Bids.....	25
37.	Withdrawal, Substitution, and Modification of Second Stage Bids	25
38.	Second Stage Bid Opening	26
E3.	Second Stage Bids: Evaluation and Comparison	27
39.	Confidentiality	27
40.	Clarification of Bids	27
41.	Deviations, Reservations, and Omissions	27
42.	Determination of Responsiveness	28
43.	Nonmaterial Nonconformities	28
44.	Correction of Arithmetical Errors.....	29
45.	Conversion to Single Currency.....	29
46.	Margin of Preference.....	29
47.	Evaluation of Second Stage Bids	29
48.	Comparison of Bids.....	30
49.	Qualification of the Bidder	30
50.	Employer’s Right to Accept Any Bid, and to Reject Any or All Bids	31
F.	Award of Contract	31
51.	Award Criteria	31
52.	Notification of Award	31
53.	Signing of Contract	32
54.	Performance Security	32
55.	Procurement Related Complaint	33

Section I. Instructions to Bidders

A. General

- 1.1 In connection with the Invitation for Bids indicated in the Bid Data Sheet (BDS), the Employer, as indicated in the BDS, issues this Bidding Document for the procurement of Works as specified in Section VI, Employer's Requirements. The name, identification, and number of lots (contracts) of the International Competitive Bidding (ICB) are **provided in the BDS**.
- 1.2 Unless otherwise stated, throughout this Bidding Document definitions and interpretations shall be as prescribed in the General Conditions, Section VII.
- 2.1 The Borrower or Recipient (hereinafter called "Borrower") **indicated in the BDS** has applied for or received financing (hereinafter called "funds") from the International Bank for Reconstruction and Development (hereinafter called "the Bank") toward the cost of the project **named in the BDS**. The Borrower intends to apply a portion of the funds to eligible payments under the contract(s) for which this Bidding Document is issued.
- 2.2 Payments by the Bank will be made only at the request of the Borrower and upon approval by the Bank in accordance with the terms and conditions of the financing agreement between the Borrower and the Bank (hereinafter called the Loan Agreement), and will be subject in all respects to the terms and conditions of that Loan Agreement. No party other than the Borrower shall derive any rights from the Loan Agreement or have any claim to the funds.
- 2.3 The Loan Agreement prohibits a withdrawal from the loan account for the purpose of any payment to persons or entities, or for any import of equipment, plant, or materials, if such payment or import is prohibited by a decision of the United Nations Security Council taken under Chapter VII of the Charter of the United Nations.
- 3.1 The Bank requires that Borrowers (including beneficiaries of Bank loans), as well as Bidders, Suppliers, Contractors and their agents (whether declared or not), personnel, subcontractors, sub-consultants, service providers and suppliers, under Bank-financed contracts, observe the highest standard of ethics during the procurement and execution of such contracts. In pursuit of this policy, the Bank:

1. Scope of Bid

2. Source of Funds

3. Corrupt Practices

- (a) defines, for the purposes of this provision, the terms set forth below as follows:
- (i) “corrupt practice” is the offering, giving, receiving or soliciting, directly or indirectly, of anything of value to influence improperly the actions of another party¹;
 - (ii) “fraudulent practice” is any act or omission, including a misrepresentation, that knowingly or recklessly misleads, or attempts to mislead, a party to obtain a financial or other benefit or to avoid an obligation²;
 - (iii) “collusive practice” is an arrangement between two or more parties³ designed to achieve an improper purpose, including to influence improperly the actions of another party;
 - (iv) “coercive practice” is impairing or harming, or threatening to impair or harm, directly or indirectly, any party⁴ or the property of the party to influence improperly the actions of a party;
 - (v) “obstructive practice” is
 - (aa) deliberately destroying, falsifying, altering or concealing of evidence material to the investigation or making false statements to investigators in order to materially impede a Bank investigation into allegations of a corrupt, fraudulent, coercive or collusive practice; and/or threatening, harassing or intimidating any party to prevent it from disclosing its knowledge of matters relevant to the investigation or from pursuing the investigation, or
 - (bb) acts intended to materially impede the exercise of the Bank’s inspection and audit rights provided for under sub-clause 3.2 below.
- (b) will reject a proposal for award if it determines that the Bidder recommended for award has, directly or

¹ “another party” refers to a public official acting in relation to the procurement process or contract execution]. In this context, “public official” includes World Bank staff and employees of other organizations taking or reviewing procurement decisions.

² “Party” refers to a public official; the terms “benefit” and “obligation” relate to the procurement process or contract execution; and the “act or omission” is intended to influence the procurement process or contract execution.

³ “Parties” refers to participants in the procurement process (including public officials) attempting to establish bid prices at artificial, non competitive levels.

⁴ “Party” refers to a participant in the procurement process or contract execution.

through an agent, engaged in corrupt, fraudulent, collusive, coercive or obstructive practices in competing for the contract in question;

- (c) will cancel the portion of the loan allocated to a contract if it determines at any time that representatives of the Borrower or of a beneficiary of the loan engaged in corrupt, fraudulent, collusive, or coercive practices during the procurement or the execution of that contract, without the Borrower having taken timely and appropriate action satisfactory to the Bank to remedy the situation; and
- (d) will sanction a firm or an individual, at any time, in accordance with prevailing Bank's sanctions procedures^a, including by publicly declaring such firm or individual ineligible, either indefinitely or for a stated period of time: (i) to be awarded a Bank-financed contract; and (ii) to be a nominated^b sub-contractor, consultant, manufacturer or supplier, or service provider of an otherwise eligible firm being awarded a Bank-financed contract.

3.2 In further pursuance of this policy, Bidders shall permit the Bank to inspect any accounts and records and other documents relating to the Bid submission and contract performance, and to have them audited by auditors appointed by the Bank. Furthermore, Bidders shall be aware of the provision stated in the General Conditions (GC) - 15.2).

4. Eligible Bidders

4.1 A Bidder may be a private entity or a government-owned entity—subject to ITB 4.5—or any combination of such entities in the form of a joint venture, or association (JVA) under an existing agreement or with the intent to enter into such an agreement supported by a letter of intent. In the case of a joint venture, or association:

- (a) **unless otherwise specified in the BDS**, all partners shall be jointly and severally liable for the execution of the Contract in accordance with the Contract terms, and

^a A firm or an individual may be declared ineligible to be awarded a Bank-financed contract upon completion of the Bank's sanctions proceedings as per its sanctions procedures, including inter alia: (i) temporary suspension in connection with an ongoing sanctions proceeding; (ii) cross-debarment as agreed with other International Financial Institutions, including Multilateral Development Banks; and (iii) the World Bank Group corporate administrative procurement sanctions procedures for fraud and corruption.

^b A nominated sub-contractor, consultant, manufacturer or supplier, or service provider (different names are used depending on the particular bidding document) is one which either has been: (i) included by the bidder in its pre-qualification application or bid because it brings specific and critical experience and know-how that are accounted for in the evaluation of the bidder's pre-qualification application or the bid; or (ii) appointed by the Borrower.

- (b) the JVA shall nominate a Representative who shall have the authority to conduct all business for and on behalf of any and all the partners of the JVA during the bidding process and, in the event the JVA is awarded the Contract, during contract execution.
- 4.2 A Bidder, and all partners constituting the Bidder, shall have a nationality of an eligible country, as defined in *Guidelines: Procurement under IBRD Loans and IDA Credits*, January 2011, (hereinafter referred to as the Guidelines), in accordance with Section V, Eligible Countries. A Bidder shall be deemed to have the nationality of a country if the Bidder is a national or is constituted, incorporated, or registered and operates in conformity with the provisions of the laws of that country. This criterion shall also apply to the determination of the nationality of proposed subcontractors or suppliers for any part of the Contract including related services.
- 4.3 A Bidder shall not have a conflict of interest. All Bidders found to have a conflict of interest shall be disqualified. A Bidder may be considered to have a conflict of interest with one or more parties in this bidding process, if :
- (a) they have a controlling partner in common; or
 - (b) they receive or have received any direct or indirect subsidy from any of them; or
 - (c) they have the same legal representative for purposes of this bid; or
 - (d) they have a relationship with each other, directly or through common third parties, that puts them in a position to have access to information about or influence on the bid of another Bidder, or influence the decisions of the Employer regarding this bidding process; or
 - (e) a Bidder submits more than one bid in this bidding process, either individually or as a partner in a joint venture, except for alternative offers permitted under ITB Clause 13. This will result in the disqualification of all such bids. However, this does not limit the participation of a Bidder as a subcontractor in another bid or of a firm as a subcontractor in more than one bid. or
 - (f) a Bidder or any of its affiliates participated as a consultant in the preparation of the design or technical specifications of the Works that are the subject of the bid.
 - (g) A Bidder or any of its affiliates has been hired (or is proposed to be hired) by the Employer or the Borrower as Engineer for the contract.

- 4.4 A Bidder that has been sanctioned by the Bank in accordance with the above ITB 3.1 (d), or in accordance with the Bank's Guidelines on Preventing and Combating Corruption in Projects Financed by IBRD Loans and IDA Credits and Grants, shall be ineligible to be awarded a Bank-financed contract, or benefit from a Bank-financed contract, financially or otherwise, during such period of time as the Bank shall determine.
- 4.5 Government-owned entities in the Borrower's country shall be eligible only if they can establish that they (i) are legally and financially autonomous, (ii) operate under the principles of commercial law, and (iii) are not dependent agencies of the Employer or the Borrower.
- 4.6 Bidders shall provide such evidence of their continued eligibility satisfactory to the Employer, as the Employer shall reasonably request.
- 4.7 In case a prequalification process has been conducted prior to the bidding process, this bidding is open only to prequalified Bidders.
- 4.8 Firms shall be excluded if:
- (a) as a matter of law or official regulation, the Borrower's country prohibits commercial relations with that country, provided that the Bank is satisfied that such exclusion does not preclude effective competition for the supply of goods or related services required; or
 - (b) by an act of compliance with a decision of the United Nations Security Council taken under Chapter VII of the Charter of the United Nations, the Borrower's country prohibits any import of goods or contracting of works or services from that country or any payments to persons or entities in that country.
- 5. Eligible Materials, Equipment and Services**
- 5.1 The materials, equipment and services to be supplied under the Contract shall have their origin in eligible source countries as defined in ITB 4.2 above and all expenditures under the Contract will be limited to such materials, equipment and services.
- 5.2 For purposes of ITB 5.1 above, "origin" means the place where the materials and equipment, or component parts thereof are mined, grown, produced or manufactured, and from which the services are provided. The materials and equipment components are produced when, through manufacturing, processing, or substantial or major assembling of components, a commercially recognized product results that is substantially in its basic characteristics or in purpose or utility from its components.

B. Contents of Bidding Document

6. Sections of Bidding Document

- 6.1 The Bidding Document consists of Parts 1, 2, 3 and 4, which include all the Sections indicated below, and should be read in conjunction with any Addenda issued in accordance with ITB 8.

PART 1 Bidding Procedures

- Section I. Instructions to Bidders (ITB)
- Section II. Bid Data Sheet (BDS)
- Section III. Evaluation and Qualification Criteria
- Section IV. Bidding Forms
- Section V. Eligible Countries

PART 2 Employer's Requirements

- Section VI. Employer's Requirements

PART 3 Conditions of Contract and Contract Forms

- Section VII. General Conditions (GC)
- Section VIII. Particular Conditions (PC)
- Appendix to Tender
- Section IX. Contract Forms

PART 4 Reference Documents

- 6.2 The Invitation for Bids issued by the Employer is not part of the Bidding Document.
- 6.3 The Employer is not responsible for the completeness of the Bidding Document and its addenda, if they were not obtained directly from the source stated by the Employer in the Invitation for Bids.
- 6.4 The Bidder is expected to examine all instructions, forms, terms, and specifications in the Bidding Document. Failure to furnish all information or documentation required by the Bidding Document may result in the rejection of the bid.

7. Clarification of Bidding Document, Site Visit, Pre-Bid Meeting

7.1 A prospective Bidder requiring any clarification of the Bidding Document shall contact the Employer in writing at the Employer's address **indicated in the BDS** or raise his enquiries during the pre-bid meeting if provided for in accordance with ITB 7.4. The Employer will respond to any request for clarification, provided that such request is received no later than twenty-eight (28) days prior to the deadline for submission of bids. The Employer's response shall be in writing with copies to all Bidders who have acquired the Bidding Document in accordance with ITB 6.3, including a description of the inquiry but without identifying its source. Should the Employer deem it necessary to amend the Bidding Document as a result of a request for clarification, it shall do so following the procedure under ITB 8, ITB 19.2 and ITB 35.2.

In addition a prospective Bidder pointing out any error/ discrepancy in Employer's Requirement shall contact the Employer in writing at the Employer's address indicated in the BDS. The Employer will respond to any such suggestion, provided that such request is received no later than twenty-eight (28) days prior to the deadline for submission of bids. The Employer's response shall be in writing with copies to all Bidders who have acquired the Bidding Document in accordance with ITB 6.3, including a description of the error/ discrepancy and accepted suggestion by the Employer but without identifying its source.

7.2 The Bidder is advised to visit and examine the site of Works and its surroundings and obtain for itself on its own responsibility all information that may be necessary for preparing the bid and entering into a contract for the design and construction of Works. The costs of visiting the site shall be at the Bidder's own expense.

7.3 The Bidder and any of its personnel or agents will be granted permission by the Employer to enter upon its premises and lands for the purpose of such visit, but only upon the express condition that the Bidder, its personnel, and agents will release and indemnify the Employer and its personnel and agents from and against all liability in respect thereof, and will be responsible for death or personal injury, loss of or damage to property, and any other loss, damage, costs, and expenses incurred as a result of the inspection.

7.4 The Bidder's designated representative is invited to attend a pre-bid meeting, if **provided for in the BDS**. The purpose of the meeting will be to clarify issues and to answer questions on any matter that may be raised at that stage.

- 7.5 The Bidder is requested, as far as possible, to submit any questions in writing, to reach the Employer not later than one week before the meeting.
- 7.6 Minutes of the pre-bid meeting, including the text of the questions raised, without identifying the source, and the responses given, together with any responses prepared after the meeting, will be transmitted promptly to all Bidders who have acquired the Bidding Document in accordance with ITB 6.3. Any modification to the Bidding Documents that may become necessary as a result of the pre-bid meeting shall be made by the Employer exclusively through the issue of an Addendum pursuant to ITB 8 and not through the minutes of the pre-bid meeting.
- 7.7 Nonattendance at the pre-bid meeting will not be a cause for disqualification of a Bidder.
- 8. Amendment of Bidding Document**
- 8.1 At any time prior to the deadline for submission of bids, the Employer may amend the Bidding Document by issuing addenda.
- 8.2 Any addendum issued shall be part of the Bidding Document and shall be communicated in writing to all who have obtained the Bidding Document from the Employer in accordance with ITB 6.3.
- 8.3 To give prospective Bidders reasonable time in which to take an addendum into account in preparing their bids, the Employer may, at its discretion, extend the deadline for the submission of bids, pursuant to ITB 19.2 and/or ITB 35.2
- 9. Cost of Bidding**
- 9.1 The Bidder shall bear all costs associated with the preparation and submission of its Bid, and the Employer shall not be responsible or liable for those costs, regardless of the conduct or outcome of the bidding process.
- 10. Language of Bid**
- 10.1 The Bid, as well as all correspondence and documents relating to the bid exchanged by the Bidder and the Employer, shall be written in the language **specified in the BDS**. Supporting documents and printed literature that are part of the Bid may be in another language provided they are accompanied by an accurate translation of the relevant passages in the language specified in the BDS, in which case, for purposes of interpretation of the Bid, such translation shall govern.

C1. First Stage Technical Proposals: Preparation

11. Documents Comprising the First Stage Technical Proposal

- 11.1 The first stage technical proposal submitted by the Bidder shall comprise the following:
- (a) Letter of First Stage Bid;
 - (b) alternative technical proposals in accordance with ITB 13;
 - (c) written confirmation authorizing the signatory of the Bid to commit the Bidder, in accordance with ITB 17.2;
 - (d) documentary evidence established in accordance with ITB 14 that the materials, equipment and services offered by the Bidder in its bid or in any alternative bid are eligible;
 - (e) documentary evidence in accordance with ITB 15 establishing the Bidder's eligibility and qualifications to perform the contract if its Bid is accepted;
 - (f) documentary evidence established in accordance with ITB 16 that the materials, equipment and services offered by the Bidder conform to the Bidding Document;
 - (g) in the case of a technical proposal submitted by a JVA, JVA agreement, or letter of intent to enter into a JVA including a draft agreement, indicating at least the parts of the Works to be executed by the respective partners;
 - (h) list of subcontractors, in accordance with ITB 16.3; and
 - (i) any other document **required in the BDS.**

First stage technical proposals are unpriced proposals and shall contain no prices or price schedules or other reference to rates and prices for completing the facilities. First stage technical proposals containing such price information will be rejected.

12. Letter of First Stage Bid and Attachments

- 12.1 The Letter of First Stage Bid and any attachments shall be prepared using the relevant forms furnished in Section IV, Bidding Forms. The forms must be completed as instructed in each form.

**13. Alternative
Technical
Proposals**

13.1 Bidders shall note that they are permitted to propose technical alternatives with their first stage technical proposals in addition to or in lieu of the requirements specified in the bidding documents, provided they can document that the proposed technical alternatives are to the benefit of the Employer, that they fulfill the principal objectives of the contract, and that they meet the basic performance and technical criteria specified in the bidding documents.

13.2 Any alternative technical proposal submitted by bidders as part of their first stage technical proposal will be the subject of clarification with the Bidder, pursuant to ITB 25.

**14. Documents
Establishing the
Eligibility of
Materials ,
Equipment and
Services**

14.1 To establish the eligibility of the materials, equipment and services in accordance with ITB Clause 5, Bidders shall provide documentary evidence consisting of a statement on the country of origin of the materials, equipment and services offered.

**15. Documents
Establishing the
Eligibility and
Qualifications of
the Bidder**

15.1 To establish its eligibility and qualifications to perform the Contract in accordance with Section III, Evaluation and Qualification Criteria, the Bidder shall provide the information requested in the corresponding information sheets included in Section IV, Bidding Forms.

15.2 Domestic Bidders, individually or in joint ventures, applying for eligibility for domestic preference shall supply all information required to satisfy the criteria for eligibility as described in ITB 46.

**16. Documents
Establishing
Conformity of
the Materials ,
Equipment and
Services**

16.1 The Bidder shall furnish a Technical Proposal including a statement of work, methods, equipments, personnel, schedule and any other information as stipulated in Section IV, in sufficient detail to demonstrate the adequacy of the Bidders' proposal to meet the work requirements and the completion time.

16.2 The documentary evidence of the conformity of the material, equipment and services with the bidding documents may be in the form of literature, drawings and data, and shall include:

- a) Adequate evidence demonstrating the substantial responsiveness of the material, equipment and services to those specifications. Bidders shall note that standards for workmanship, materials and equipment designated by the Employer in the Bidding Document are intended to be descriptive (establishing standards of quality and performance) only and not restrictive. The Bidder may substitute alternative standards, brand

names and/or catalog numbers in its technical proposal, provided that it demonstrates to the Employer's satisfaction that the substitutions are substantially equivalent or superior to the standards designated in the Specification.

- 16.3 For major items of supply or services as listed by the Employer in Section III, Evaluation and Qualification Criteria, which the Bidder intends to purchase or subcontract, the Bidder shall give details of the name and nationality of the proposed Subcontractors, including manufacturers, for each of those items. In addition, the Bidder shall include in its technical proposal information establishing compliance with the requirements specified by the Employer for these items.
- 16.4 The Bidder shall be responsible for ensuring that any Subcontractor proposed complies with the requirements of ITB 4, and that any materials, equipment or services to be provided by the Subcontractor comply with the requirements of ITB 5 and 15.1.

**17. Format and
Signing of First
Stage Technical
Proposal**

- 17.1 The Bidder shall prepare one original of the documents comprising the bid as described in ITB 11 and clearly mark it "FIRST STAGE TECHNICAL PROPOSAL - ORIGINAL." Alternative bids, if permitted in accordance with ITB 13, shall be clearly marked "FIRST STAGE TECHNICAL PROPOSAL - ALTERNATIVE". In addition, the Bidder shall submit copies of the bid, in the number **specified in the BDS** and clearly mark them "FIRST STAGE TECHNICAL PROPOSAL - COPY" and, "FIRST STAGE TECHNICAL PROPOSAL – ALTERNATIVE - COPY" In the event of any discrepancy between the original and the copies, the original shall prevail.
- 17.2 The original and all copies of the first stage technical proposal shall be typed or written in indelible ink and shall be signed by a person duly authorized to sign on behalf of the Bidder. This authorization shall consist of a written confirmation as **specified in the BDS** and shall be attached to the first stage technical proposal. The name and position held by each person signing the authorization must be typed or printed below the signature. All pages of the first stage technical proposal where entries or amendments have been made shall be signed or initialed by the person signing the bid.

- 17.3 A bid submitted by a JVA shall be signed so as to be legally binding on all partners.
- 17.4 Any interlineations, erasures, or overwriting shall be valid only if they are signed or initialed by the person signing the bid.

C2. First Stage Technical Proposals: Submission and Opening

18. Submission, Sealing and Marking of First Stage Technical Proposals

18.1 Bidders may always submit their first stage technical proposals by mail or by hand. When so **specified in the BDS**, bidders shall have the option of submitting their first stage technical proposals electronically.

- (a) Bidders submitting first stage technical proposals by mail or by hand, shall enclose the original and each copy of the technical proposal, including alternative technical proposals, if permitted in accordance with ITB 13, in separate sealed envelopes, duly marking the envelopes as “FIRST STAGE TECHNICAL PROPOSAL - ORIGINAL”, “FIRST STAGE TECHNICAL PROPOSAL - ALTERNATIVE” and “FIRST STAGE TECHNICAL PROPOSAL - COPY” and, “FIRST STAGE TECHNICAL PROPOSAL – ALTERNATIVE - COPY” These envelopes containing the original and the copies shall then be enclosed in one single envelope. The rest of the procedure shall be in accordance with ITB 21.2 and 21.3.
- (b) Bidders submitting first stage technical proposals electronically shall follow the electronic submission procedures **specified in the BDS**.

18.2 The inner and outer envelopes shall:

- (a) bear the name and address of the Bidder;
- (b) be addressed to the Employer in accordance with ITB 19.1;
- (c) bear the specific identification of this bidding process indicated in accordance with ITB 1.1; and
- (d) bear a warning not to open before the time and date for bid opening.

- 18.3 If all envelopes are not sealed and marked as required, the Employer will assume no responsibility for the misplacement or premature opening of the technical proposal.
- 19. Deadline for Submission of First Stage Technical Proposals**
- 19.1 First stage technical proposals must be received by the Employer at the address and no later than the date and time **indicated in the BDS**. Any first stage technical proposal received by the Employer after the deadline for submission of bids shall be declared late, rejected, and returned unopened to the Bidder.
- 19.2 The Employer may, at its discretion, extend the deadline for the submission of first stage technical proposals by amending the Bidding Document in accordance with ITB 8, in which case all rights and obligations of the Employer and Bidders previously subject to the deadline shall thereafter be subject to the deadline as extended.
- 20. Substitution and Modification of First Stage Technical Proposals**
- 20.1 In case a Bidder wishes to substitute or modify its first stage technical proposal after it has been submitted and prior to the deadline for first stage technical proposal submission, it may do so by sending a written notice, as per ITB 19.1 and its substituted or modified first stage technical proposal will be opened as per ITB 21.
- 21. Opening of First Stage Technical Proposals by Employer**
- 21.1 The Employer shall conduct the bid opening of the first stage technical proposals in public, in the presence of Bidders` designated representatives and anyone who choose to attend, and at the address, date and time **specified in the BDS**. Any specific procedures required if electronic bidding is permitted in accordance with ITB 18.1 shall be as **specified in the BDS**.
- 21.2 The names of all bidders who submitted first stage technical proposals will be read out, and other such details as the Employer, at its discretion, may consider appropriate, will be announced at the opening.
- 21.3 The Employer shall prepare a record of the first stage technical proposal opening that shall include, as a minimum: the name of the Bidder, including any alternative bids. The Bidders` representatives who are present shall be requested to sign the record. The omission of a Bidder`s signature on the record shall not invalidate the contents and effect of the record. A copy of the record shall be distributed to all Bidders who submitted technical proposals in time, and posted online when electronic bidding is permitted.

C3. First Stage Technical Proposals: Evaluation

22. Determination of Responsiveness of First Stage Technical Proposals

- 22.1 The Employer will examine the first stage technical proposals to determine whether they are complete, whether the documents have been properly signed and whether the bids are generally in order. Any bids found to be non responsive or not meeting the minimum levels of the performance or other criteria specified in the bidding document will be rejected by the Employer and not included for further consideration. The Employer will also carry out a preliminary examination of any alternative bids submitted by bidders.
- 22.2 The Employer may request that the Bidder submit the necessary information or documentation, within a reasonable period of time, to rectify nonmaterial omissions in the first stage technical proposal related to documentation requirements. Failure of the Bidder to comply with the request may result in the rejection of its technical proposal.

23. Technical Evaluation of First Stage Technical Proposals

- 23.1 The Employer will carry out a detailed evaluation of the first stage technical proposals in order to determine whether the technical aspects are in compliance with the Bidding Document. In order to reach such a determination, the Employer will examine and compare the technical proposals on the basis of the information supplied by the bidders, taking into account overall completeness and compliance with the Employer's Requirements and the technical merits of alternatives offered;
- (a) overall completeness and compliance with the Employer's Requirements; the technical merits of alternatives offered; conformity of the Works offered with specified performance criteria, including conformity with the specified minimum (or maximum, as the case may be) requirement corresponding to each functional guarantee, as indicated in the Specification and in Section III - Evaluation and Qualification Criteria; suitability of the Works offered in relation to the environmental and climatic conditions prevailing at the site; and quality, function and operation of any process control concept included in the bid;
 - (b) Compliance with the time schedule called for in the corresponding Appendix to the Contract Agreement and any alternative time schedules offered by bidders, as evidenced by a milestone schedule provided in the technical proposal;
 - (c) other relevant factors, if any, listed in Section III, Evaluation and Qualification Criteria; and

(d) any deviations to the commercial and contractual provisions stipulated in the bidding documents

23.2 The Employer will also review complete alternative technical proposals, if any, offered by the Bidder, pursuant to ITB 13, to determine whether such alternatives may constitute an acceptable basis for a Second Stage bid to be submitted on its own merits.

24. Eligibility and Qualification of the Bidder

24.1 The Employer shall determine to its satisfaction whether Bidders determined as having submitted responsive First Stage Technical Proposals are eligible and meet the qualification criteria specified in Section III, Evaluation and Qualification Criteria.

24.2 The determination shall be based upon an examination of the documentary evidence of the Bidder's qualifications submitted by the Bidder, pursuant to ITB 15, and on any additional information which the Employer may request from the Bidder to support such evidence.

24.3 An affirmative determination will be a prerequisite for the Employer to invite the Bidder to a clarification meeting in accordance with ITB 25. A negative determination will result in rejection of the Bidder's first stage technical proposal.

24.4 The capabilities of the manufacturers and subcontractors proposed to be used by the Bidders for Employer-identified major items of supply or services will also be evaluated for acceptability in accordance with Section III, Evaluation and Qualification Criteria. Should a manufacturer or subcontractor be determined to be unacceptable, if invited to submit a Second Stage Bid, the Bidder will be required to substitute an acceptable manufacturer or subcontractor.

D. Clarification of First Stage Technical Proposals

25. Clarification Procedures

25.1 The Employer may conduct clarification meetings with each or any Bidder to clarify any aspects of its First Stage technical proposal that require explanation and to review any Bidder's proposed alternative solutions or reservations to the commercial or contractual provisions of the bidding documents. The Employer may also seek clarifications in writing.

25.2 The Employer may bring to the attention of the Bidder any amendments or changes which the Employer may require to be made to the First Stage technical proposal; however the Employer may not require amendments or changes at variance from the Employers' requirements unless the Employer intends to amend the Bidding Document in accordance with ITB 26.1(a).

- 25.3 The Employer will advise the Bidder of any deviations to the commercial or contractual provisions of the bidding documents in the First Stage technical proposal, that are unacceptable and that are to be withdrawn in the Second Stage bid.
- 25.4 The Employer will also advise the Bidder whether the proposed alternative technical proposal, if any, is acceptable, and will identify the degree (if any) to which such an alternative bid may be incorporated in the Bidder's Second Stage bid.
- 25.5 The Employer will issue a Memorandum titled "***Changes Required Pursuant to First Stage Evaluation,***" documenting the clarifications made in writing and/or in a meeting, if any, and including an Annex listing all decisions, and required amendments or changes resulting from the clarification of the First Stage technical proposal. The Memorandum will be communicated to the Bidder as part of the invitation to submit the Second Stage bid.
- 26. Invitation to Submit Second Stage Bids**
- 26.1 At the end of the clarification process pursuant to ITB 25, conducted as necessary:
- (a) the Employer may need to issue an amendment to the Bidding Document resulting from the First Stage evaluation and clarification process, with the objective of clarifying the requirements and improving competition without compromising essential project objectives and/or
 - (b) in regard to all bidders, the Employer will either:
 - (i) invite the Bidder to submit a final updated technical and a commercial Second Stage bid based on its First Stage technical proposal taking into account the Bidding Document, if and as amended, and any other modifications as recorded in the Annex to the Memorandum entitled "Changes Required Pursuant to First Stage Evaluation". Bidders will be allowed to submit only one Second Stage Bid, or
 - (ii) notify the Bidder that its bid has been rejected on the grounds of being substantially non-responsive, or that the Bidder does not meet the minimum qualification requirements set forth in the Bidding Document.
- 26.2 The deadline, for submission of Second Stage bids will be specified in the invitation to submit Second Stage bids, pursuant to ITB 35.1.
- 26.3 Bidders are not allowed to form JVA(s) with other bidders, nor change the partner or structure of the JVA if the Bidder in the First Stage was a JVA.

E1. Second Stage Bid Preparation

27. Documents Comprising the Bid

27.1 The Second Stage Bid submitted by the Bidder shall comprise the following:

- (a) Letter of Bid
- (b) Completed schedules as required, including Price Schedules, in accordance with ITB 28 and 29;
- (c) Bid Security, in accordance with ITB 32;
- (d) written confirmation authorizing the signatory of the Bid to commit the Bidder, in accordance with ITB 33.2;
- (d) the updated first stage technical proposal, comprising any modifications required to the first stage technical proposal as recorded in the Memorandum entitled “Changes Required Pursuant to First Stage Evaluation”;
- (f) documentary evidence established in accordance with ITB 14 that any additional or varied materials, equipment and services offered by the Bidder, and not included in the first stage technical proposal, are eligible;
- (g) documentary evidence regarding any changes that may have occurred between the time of submitting the First and Second Stage bids that have any material effect on the Bidder’s eligibility and qualifications to perform the Contract.
- (h) documentary evidence establishing that any additional or varied facilities to be supplied and installed by the Bidder, in accordance with the requirements of the Memorandum entitled “Changes Required Pursuant to First Stage Evaluation”, are technically acceptable. The documentary evidence of the conformity of the materials, equipment and services to the requirements of the Memorandum entitled “Changes Required Pursuant to First Stage Evaluation” may be in the form of literature, drawings and data. The functional guarantees of any additional or varied materials, equipment and services shall be stated in the applicable form in Section IV Bidding Forms.
- (i) If the Bidder proposes to engage any Subcontractors additional to or different from those named in its first stage technical proposal for major items of

supply or services as listed by the Employer in Section III, Evaluation and Qualification Criteria, which the Bidder intends to purchase or subcontract, the Bidder shall give details of the name and nationality of the proposed Subcontractors, including manufacturers, for each of those items. In addition, the Bidder shall include in its bid information establishing compliance with the requirements specified by the Employer for these items. Quoted rates and prices will be deemed to apply to whichever Subcontractor is appointed, and no adjustment of the rates and prices will be permitted.

- (j) other documentation and information which may be **specified in the BDS.**

28. Letter of Bid, and Schedules

28.1 The Bidder shall complete the Letter of Bid and Schedules, including the appropriate Price Schedules, using the relevant forms furnished in Section IV, Bidding Forms. The forms must be completed as instructed in each form.

29. Bid Prices and Discounts

29.1 Unless otherwise **specified in the BDS**, bidders shall quote for the entire Works on a “single responsibility” basis such that the total bid price covers all the Contractor’s obligations mentioned in or to be reasonably inferred from the bidding document in respect of the design, manufacture, including procurement and subcontracting (if any), delivery, construction, installation and completion of the Works. This includes all requirements under the Contractor’s responsibilities for testing, pre-commissioning and commissioning of the Works and, where so required by the bidding document, the acquisition of all permits, approvals and licenses, etc.; the operation, maintenance and training services and such other items and services as may be specified in the Bidding Document, all in accordance with the requirements of the General Conditions. Items against which no price is entered by the Bidder will not be paid for by the Employer when executed and shall be deemed to be covered by the prices for other items.

29.2 Bidders shall give a breakdown of the prices in the manner and detail called for in the Price Schedules (under Terms and Procedures for Payment) included in Section IV, Bidding Forms.

29.3 The prices shall be either fixed or adjustable as **specified in the BDS.**

29.4 In the case of **Fixed Price**, prices quoted by the Bidder shall be fixed during the Bidder’s performance of the contract and not subject to variation on any account. A bid submitted with an adjustable price quotation will be treated as non responsive and rejected.

- 29.5 In the case of **Adjustable Price**, prices quoted by the Bidder shall be subject to adjustment during performance of the contract to reflect changes in the cost elements such as steel, cement, labour, fuel & lubricants and machinery & machine tools in accordance with the procedures specified in the corresponding Appendix to Tender in Section VIII, Part 3 of the bid documents.
- 29.6 If so indicated in ITB 1.1, bids are being invited for individual lots (contracts) or for any combination of lots (packages). Bidders wishing to offer any price reduction (discount) for the award of more than one Contract shall specify in their Letter of Bid the price reductions applicable to each package, or alternatively, to individual Contracts within the package, and the manner in which the price reductions will apply.
- 29.7 Bidders wishing to offer any unconditional discount shall specify in their Letter of Bid the offered discounts and the manner in which price discounts will apply.
- 29.8 **Unless otherwise specified in the BDS**, all duties, taxes and other levies payable by the Contractor under the contract, or for any other cause, as of the date 28 days prior to the deadline for submission of bids, shall be included in the total Bid Price submitted by the Bidder.
- 30. Currencies of Bid and Payment**
- 30.1 The currency (ies) of the bid and the currency (ies) of payments shall be, as **specified in the BDS**.
- 30.2 Bidders may be required by the Employer to justify, to the Employer's satisfaction, their local and foreign currency requirements.
- 31. Period of Validity of Bids**
- 31.1 Second Stage Bids shall remain valid for the period specified in the BDS after the bid submission deadline date prescribed by the Employer pursuant to ITB 35.1. **A bid valid for a shorter period shall be rejected by the Employer as non responsive.**
- 31.2 In exceptional circumstances, prior to the expiration of the bid validity period, the Employer may request Bidders to extend the period of validity of their bids. The request and the responses shall be made in writing. If a bid security is requested in accordance with ITB 32, the Bidder granting the request shall also extend the bid security for twenty-eight (28) days beyond the deadline of the extended validity period. A Bidder may refuse the request without forfeiting its bid security. A Bidder granting the request shall not be required or permitted to modify its bid, except as provided in ITB 31.3.

31.3 In the case of fixed price contracts, if the award is delayed by a period exceeding fifty-six (56) days beyond the expiry of the initial bid validity, the Contract price shall be adjusted by a factor or factors specified in the request for extension. Bid evaluation shall be based on the Bid Price without taking into consideration the above correction.

32. Bid Security

32.1 The Bidder shall furnish as part of its bid, either a Bid-Securing Declaration or a bid security as specified in the BDS, in original form and in the amount **specified in the BDS**.

32.2 A Bid-Securing Declaration shall use the form included in Section IV Bidding Forms.

32.3 If a bid security is specified pursuant to ITB 32.1, the bid security shall be a demand guarantee in any of the following forms, unless otherwise specified in the BDS, at the Bidder's option,:

- (a) an unconditional guarantee issued by a bank *or surety*;
- (b) an irrevocable letter of credit;
- (c) a cashier's or certified check; or
- (d) another security **indicated in the BDS**,

from a reputable source from an eligible country. If the unconditional guarantee is issued by an insurance company or a bonding company located outside the Employer's Country, the issuer shall have a correspondent financial institution located in the Employer's Country to make it enforceable. In the case of a bank guarantee, the bid security shall be submitted either using the Bid Security Form included in Section IV, Bidding Forms or in another substantially similar format approved by the Employer prior to bid submission. In either case, the form must include the complete name of the Bidder. The bid security shall be valid for twenty-eight days (28) beyond the original validity period of the bid, or beyond any period of extension if requested under ITB 31.2.

32.4 If a bid security is specified pursuant to ITB 32.1, any bid not accompanied by a substantially responsive bid security or Bid-Securing Declaration shall be rejected by the Employer as non responsive.

32.5 If a bid security is specified pursuant to ITB 32.1, the bid security of unsuccessful Bidders shall be returned as promptly as possible upon the successful Bidder's furnishing of the performance security and if required in the BDS, the Environmental, Social, Health and Safety

(ESHS) Performance Security pursuant to ITB 54.

- 32.6 The bid security of the successful Bidder shall be returned as promptly as possible once the successful Bidder has signed the Contract and furnished the required performance security, and if required in the BDS, the Environmental, Social, Health and Safety (ESHS) Performance Security.
- 32.7 The bid security may be forfeited or the Bid-Securing Declaration executed:
- (a) if a Bidder withdraws its bid during the period of bid validity specified by the Bidder on the Letter of Bid, or
 - (b) if the successful Bidder fails to:
 - (i) sign the Contract in accordance with ITB 53; or
 - (ii) furnish a performance security and if required in the BDS, the Environmental, Social, Health and Safety (ESHS) Performance Security in accordance with ITB 54.
- 32.8 The Bid Security or the Bid Securing Declaration of a JVA shall be in the name of the JVA that submits the bid. If the JVA has not been constituted into a legally enforceable JVA at the time of bidding, the Bid Security shall be in the names of all future partners as named in the letter of intent referred to in ITB 4.1.
- 32.9 If a Bid-Securing Declaration is executed in accordance with ITB 32.7, the Employer will declare the Bidder ineligible to be awarded a contract by the Employer for the period of time stated in the Form of Bid-Securing Declaration.
- 32.10 If a bid security is not required in the BDS, and
- (a) if a Bidder withdraws its bid during the period of bid validity specified by the Bidder on the Letter of Bid Form, except as provided in ITB 32.2, or
 - (b) if the successful Bidder fails to: sign the Contract in accordance with ITB 53; or furnish a performance security and if required in the BDS, the Environmental, Social, Health and Safety (ESHS) performance security in accordance with ITB 54;

the Borrower may, **if provided for in the BDS**, declare the Bidder disqualified to be awarded a contract by the Employer for a period of time **as stated in the BDS**.

**33. Format and
Signing of Second
Stage Bid**

- 33.1 The Bidder shall prepare one original of the documents comprising the bid as described in ITB 27 and clearly mark it “SECOND STAGE BID - ORIGINAL.” In addition, the Bidder shall submit copies of the bid, in the number **specified in the BDS** and clearly mark them “SECOND STAGE BID - COPY.” In the event of any discrepancy between the original and the copies, the original shall prevail.
- 33.2 The original and all copies of the bid shall be typed or written in indelible ink and shall be signed by a person duly authorized to sign on behalf of the Bidder. This authorization shall consist of a written confirmation as **specified in the BDS** and shall be attached to the bid. The name and position held by each person signing the authorization must be typed or printed below the signature. All pages of the bid where entries or amendments have been made shall be signed or initialed by the person signing the bid.
- 33.3 A bid submitted by a JVA shall comply with the following requirements:
- (a) Unless not required in accordance with ITB 4.1 (a), be signed so as to be legally binding on all partners and
 - (b) Include the Representative’s authorization referred to in ITB 4.1 (b), consisting of a power of attorney signed by those legally authorized to sign on behalf of the JVA.
- 33.4 Any interlineations, erasures, or overwriting shall be valid only if they are signed or initialed by the person signing the bid.

E2. Second Stage Bids: Submission and Opening

**34. Submission,
Sealing and
Marking of
Second Stage
Bids**

- 34.1 Bidders may always submit their bids by mail or by hand. When so **specified in the BDS**, bidders shall have the option of submitting their bids electronically. Procedures for submission, sealing and marking are as follows:
- 34.2 Bidders submitting bids by mail or by hand shall enclose the original and each copy of the Bid, in separate sealed envelopes, duly marking the envelopes as “SECOND STAGE BID - ORIGINAL”, and “SECOND STAGE BID - COPY.” These envelopes containing the original and the copies shall then be enclosed in one single envelope. The rest of the procedure shall be in accordance with ITB 34.2 and 34.3.
- 34.3 Bidders submitting bids electronically shall follow the electronic bid submission procedures **specified in the BDS**.

- 34.4 The inner and outer envelopes shall:
- (a) bear the name and address of the Bidder;
 - (b) be addressed to the Employer in accordance with ITB 35.1;
 - (c) bear the specific identification of this bidding process indicated in the BDS 1.1; and
 - (d) bear a warning not to open before the time and date for bid opening.
- 34.5 If all envelopes are not sealed and marked as required, the Employer will assume no responsibility for the misplacement or premature opening of the bid.
- 35. Deadline for Submission of Second Stage Bids**
- 35.1 Second Stage bids must be received by the Employer at the address and no later than the date and time indicated in the Letter of Invitation to submit Second Stage Bids.
- 35.2 The Employer may, at its discretion, extend the deadline for the submission of bids by amending the Bidding Document in accordance with ITB 8, in which case all rights and obligations of the Employer and Bidders previously subject to the deadline shall thereafter be subject to the deadline as extended.
- 36. Late Bids**
- 36.1 The Employer shall not consider any bid that arrives after the deadline for submission of bids, in accordance with ITB 35. Any bid received by the Employer after the deadline for submission of bids shall be declared late, rejected, and returned unopened to the Bidder.
- 37. Withdrawal, Substitution, and Modification of Second Stage Bids**
- 37.1 A Bidder may withdraw, substitute, or modify its bid after it has been submitted by sending a written notice, duly signed by an authorized representative, and shall include a copy of the authorization in accordance with ITB 33.2, (except that withdrawal notices do not require copies). The corresponding substitution or modification of the bid must accompany the respective written notice. All notices must be:
- (a) prepared and submitted in accordance with ITB 33 and ITB 34 (except that withdrawals notices do not require copies), and in addition, the respective envelopes shall be clearly marked “SECOND STAGE BID - WITHDRAWAL,” “SECOND STAGE BID - SUBSTITUTION,” “SECOND STAGE BID - MODIFICATION;” and
 - (b) received by the Employer prior to the deadline prescribed for submission of bids, in accordance with ITB 35

- 37.2 Bids requested to be withdrawn in accordance with ITB 37.1 shall be returned unopened to the Bidders.
- 37.3 No bid may be withdrawn, substituted, or modified in the interval between the deadline for submission of Second Stage bids and the expiration of the period of bid validity specified by the Bidder on the Letter of Bid or any extension thereof.
- 38. Second Stage Bid Opening**
- 38.1 The Employer shall conduct the Second Stage bid opening in public, in the presence of Bidders` designated representatives and anyone who choose to attend, and at the address, date and time specified in the Letter of Invitation to submit Second Stage Bids. Any specific electronic bid opening procedures required if electronic bidding is permitted in accordance with ITB 34.1, shall be as **specified in the BDS.**
- 38.2 First, envelopes marked “SECOND STAGE BID - WITHDRAWAL” shall be opened and read out and the envelope with the corresponding bid shall not be opened, but returned to the Bidder. No bid withdrawal shall be permitted unless the corresponding withdrawal notice contains a valid authorization to request the withdrawal and is read out at bid opening. Next, envelopes marked “SECOND STAGE BID - SUBSTITUTION” shall be opened and read out and exchanged with the corresponding bid being substituted, and the substituted bid shall not be opened, but returned to the Bidder. No bid substitution shall be permitted unless the corresponding substitution notice contains a valid authorization to request the substitution and is read out at bid opening. Envelopes marked “SECOND STAGE BID - MODIFICATION” shall be opened and read out with the corresponding bid. No bid modification shall be permitted unless the corresponding modification notice contains a valid authorization to request the modification and is read out at bid opening. Only bids that are opened and read out at bid opening shall be considered further.
- 38.3 All other envelopes shall be opened one at a time, reading out: the name of the Bidder and the Bid Price(s), including any discounts, and indicating whether there is a modification; the presence or absence of a bid security or a Bid-Securing Declaration; and any other details as the Employer may consider appropriate. Only discounts read out at bid opening shall be considered for evaluation. No bid shall be rejected at bid opening except for late bids, in accordance with ITB 36.1.
- 38.4 The Employer shall prepare a record of the bid opening that shall include, as a minimum: the name of the Bidder and whether there is a withdrawal, substitution, or

modification; the Bid Price, per lot if applicable, including any discounts; and the presence or absence of a bid security or a Bid-Securing Declaration. The Bidders' representatives who are present shall be requested to sign the record. The omission of a Bidder's signature on the record shall not invalidate the contents and effect of the record. A copy of the record shall be distributed to all Bidders who submitted bids in time, and posted online when electronic bidding is permitted.

E3. Second Stage Bids: Evaluation and Comparison

- 39. Confidentiality**
- 39.1 Consistent with the requirements of transparency and intellectual property rights, in revising the Second Stage Technical Proposal, information contained in the Bidder's Technical Proposal reviewed in the first stage shall not be disclosed to Bidders or any other persons not officially concerned with such process until information on contract award is communicated to all Bidders,.
- 39.2 Any attempt by a Bidder to influence the Employer in the evaluation of the first and second stage bids or Contract award decisions may result in the rejection of its bid.
- 39.3 Notwithstanding ITB 39.2, from the time of First Stage technical proposal opening to the time of Contract award, if any Bidder wishes to contact the Employer on any matter related to the bidding process, it should do so in writing.
- 40. Clarification of Bids**
- 40.1 To assist in the examination, evaluation, and comparison of the bids, and qualification of the Bidders, the Employer may, at its discretion, ask any Bidder for a clarification of its bid. Any clarification submitted by a Bidder that is not in response to a request by the Employer shall not be considered. The Employer's request for clarification and the response shall be in writing. No change in the prices or substance of the bid shall be sought, offered, or permitted, except to confirm the correction of arithmetic errors discovered by the Employer in the evaluation of the bids, in accordance with ITB 44.1.
- 40.2 If a Bidder does not provide clarifications of its bid by the date and time set in the Employer's request for clarification, its bid may be rejected.
- 41. Deviations, Reservations, and Omissions**
- 41.1 During the evaluation of bids, the following definitions apply:
- (a) "Deviation" is a departure from the requirements specified in the Bidding Document;

- (b) “Reservation” is the setting of limiting conditions or withholding from complete acceptance of the requirements specified in the Bidding Document; and
- (c) “Omission” is the failure to submit part or all of the information or documentation required in the Bidding Document.

42. Determination of Responsiveness

42.1 The Employer’s determination of a bid’s responsiveness is to be based on the contents of the bid itself, as defined in ITB 27.

42.2 A substantially responsive bid is one that meets the requirements of the Bidding Document and has properly incorporated all modifications listed in the Memorandum entitled “*Changes Required Pursuant to First Stage Evaluation*”, without material deviation, reservation, or omission. A material deviation, reservation, or omission is one that,

- (a) if accepted, would:
 - (i) affect in any substantial way the scope, quality, or performance of the Works specified in the Contract; or
 - (ii) limit in any substantial way, inconsistent with the Bidding Document, the Employer’s rights or the Bidder’s obligations under the proposed Contract; or
- (b) if rectified, would unfairly affect the competitive position of other Bidders presenting substantially responsive bids.

42.3 A Second Stage bid containing technical or commercial alternatives not submitted as part of the first stage technical proposal will be treated as non responsive.

42.4 If a bid is not substantially responsive to the requirements of the Bidding Document, it shall be rejected by the Employer and may not subsequently be made responsive by correction of the material deviation, reservation, or omission.

43. Nonmaterial Nonconformities

43.1 Provided that a bid is substantially responsive, the Employer may waive any nonconformities in the bid that do not constitute a material deviation, reservation or omission.

43.2 Provided that a bid is substantially responsive, the Employer may request that the Bidder submit the necessary information or documentation, within a reasonable period

of time, to rectify quantifiable nonmaterial nonconformities in the bid related to documentation requirements. Requesting information or documentation on such nonconformities shall not be related to any aspect of the price of the bid. Failure of the Bidder to comply with the request may result in the rejection of its bid.

43.3 Provided that a bid is substantially responsive, the Employer shall rectify nonmaterial nonconformities related to the Bid Price. To this effect, the Bid Price shall be adjusted, for comparison purposes only, to reflect the price of a missing or non-conforming item or component. The adjustment shall be made using the method indicated in Section III, Evaluation and Qualification Criteria.

**44. Correction of
Arithmetical
Errors**

44.1 Provided that the bid is substantially responsive, the Employer shall correct arithmetical errors on the following basis:

- (a) where there are errors between the total of the amounts given under the column for the price breakdown and the amount given under the Total Price, the former shall prevail and the latter will be corrected accordingly;
- (b) if there is a discrepancy between words and figures, the amount in words shall prevail, unless the amount expressed in words is related to an arithmetic error, in which case the amount in figures shall prevail subject to (a) above.

44.2 If the Bidder that submitted the lowest evaluated bid does not accept the correction of errors, its bid shall be declared non-responsive.

**45. Conversion to
Single Currency**

45.1 For evaluation and comparison purposes, the currency (ies) of the bid shall be converted into a single currency as **specified in the BDS.**

**46. Margin of
Preference**

46.1 No margin of domestic preference shall apply.

**47. Evaluation of
Second Stage
Bids**

47.1 The Employer shall use the criteria and methodologies indicated in this Clause. No other evaluation criteria or methodologies shall be permitted.

Technical Evaluation

47.2 The Employer will carry out a detailed evaluation of the Second Stage bids not previously rejected to determine whether the technical aspects concerning the modifications

to the technically acceptable base or alternative bid detailed in the Memorandum entitled “Changes Required Pursuant to First Stage Evaluation”, pursuant to ITB 26.1, have been properly addressed and are substantially responsive to the requirements set forth in the Bidding Document.

Economic Evaluation

47.3 To evaluate a bid, the Employer shall consider the following:

- (a) the bid price, excluding provisional sums and the provision, if any, for contingencies in the Price Schedules;
- (b) price adjustment for correction of arithmetic errors in accordance with ITB 44.1;
- (c) price adjustment due to discounts offered in accordance with ITB 29.6 and ITB 29.7;
- (d) price adjustment due to quantifiable nonmaterial nonconformities in accordance with ITB 43.3;
- (e) converting the amount resulting from applying (a) to (d) above, if relevant, to a single currency in accordance with ITB 45; and
- (f) the evaluation factors, if any, indicated in Section III, Evaluation and Qualification Criteria.

47.4 If price adjustment is allowed in accordance with ITB 29.3, the estimated effect of the price adjustment provisions of the Conditions of Contract, applied over the period of execution of the Contract, shall not be taken into account in bid evaluation.

47.5 If this Bidding Document allows Bidders to quote separate prices for different lots (contracts), and the award to a single Bidder of multiple lots (contracts), the methodology to determine the lowest evaluated price of the lot (contract) combinations, including any discounts offered in the Letter of Bid, is specified in Section III, Evaluation and Qualification Criteria.

48. Comparison of Bids

48.1 The Employer shall compare all substantially responsive bids in accordance with ITB 47.3 to determine the lowest evaluated bid.

49. Qualification of the Bidder

49.1 The Employer shall determine to its satisfaction whether the Bidder that is selected as having submitted the lowest evaluated and substantially responsive bid still meets the qualifying criteria specified in Section III, Evaluation and Qualification Criteria.

49.2 An affirmative determination shall be a prerequisite for

award of the Contract to the Bidder. A negative determination shall result in disqualification of the bid, in which event the Employer shall proceed to the next lowest evaluated bid to make a similar determination of that Bidder's qualifications to perform satisfactorily.

49.3 The participation of the manufacturers and subcontractors proposed in its Bid to be used by the lowest evaluated Bidder should be confirmed with a letter of intent between the parties, as needed. The capabilities of additional or different manufacturers and subcontractors proposed in its Bid to be used by the lowest evaluated Bidder will also be evaluated for acceptability in accordance with Section III, Evaluation and Qualification Criteria. Should any additional or substitute manufacturer or subcontractor be determined to be unacceptable, the Bid will not be rejected, but the Bidder will be required to substitute an acceptable manufacturer or subcontractor without any change to the bid price. Prior to signing the Contract, the corresponding Appendix to the Contract Agreement shall be completed, listing the approved manufacturers or subcontractors for each item concerned.

50. Employer's Right to Accept Any Bid, and to Reject Any or All Bids

50.1 The Employer reserves the right to accept or reject any bid, and to annul the bidding process and reject all bids at any time prior to contract award, without thereby incurring any liability to Bidders. In case of annulment, all bids submitted and specifically, bid securities, shall be promptly returned to the Bidders.

F. Award of Contract

51. Award Criteria

51.1 Subject to ITB 50.1, the Employer shall award the Contract to the Bidder whose offer has been determined to be the lowest evaluated bid and is substantially responsive to the Bidding Document, provided further that the Bidder is determined to be eligible and qualified to perform the Contract satisfactorily.

52. Notification of Award

52.1 Prior to the expiration of the period of bid validity, the Employer shall notify the successful Bidder, in writing, that its bid has been accepted. The notification letter (hereinafter and in the Conditions of Contract and Contract Forms called the "Letter of Acceptance") shall specify the sum that the Employer will pay the Contractor in consideration of the execution and completion of the Works (hereinafter and in the Conditions of Contract and Contract Forms called "the Contract Price").

52.2 At the same time, the Employer shall also notify all other Bidders of the results of the bidding, and shall publish in UNDB online and in the dgMarket the results identifying the bid and lot numbers and the following information: (i) name of each Bidder who submitted a Bid; (ii) bid prices as

read out at Bid Opening; (iii) name and evaluated prices of each Bid that was evaluated; (iv) name of bidders whose bids were rejected and the reasons for their rejection; and (v) name of the winning Bidder, and the Price it offered, as well as the duration and summary scope of the contract awarded.

52.3 Until a formal contract is prepared and executed, the notification of award shall constitute a binding Contract.

52.4 The Employer shall promptly respond in writing to any unsuccessful Bidder who, after notification of award in accordance with ITB 52.1, requests in writing the grounds on which its bid was not selected.

53. Signing of Contract

53.1 Promptly upon notification, the Employer shall send the successful Bidder the Contract Agreement.

53.2 Within twenty-eight (28) days of receipt of the Contract Agreement, the successful Bidder shall sign, date, and return it to the Employer.

53.3 Notwithstanding ITB 53.2 above, in case signing of the Contract Agreement is prevented by any export restrictions attributable to the Employer, to the country of the Employer, or to the use of the materials, equipment and services to be supplied, where such export restrictions arise from trade regulations from a country supplying those materials, equipment and services, the Bidder shall not be bound by its bid, always provided, however, that the Bidder can demonstrate to the satisfaction of the Employer and of the Bank that signing of the Contract Agreement has not been prevented by any lack of diligence on the part of the Bidder in completing any formalities, including applying for permits, authorizations and licenses necessary for the export of the materials, equipment and services under the terms of the Contract.

54. Performance Security

54.1 Within twenty-eight (28) days of the receipt of notification of award from the Employer, the successful Bidder shall furnish the performance security and if required in the BDS, the Environmental, Social, Health and Safety (ESHS) Performance Security in accordance with the General Conditions of Contract, using for that purpose the Performance Security and ESHS Performance Security Forms included in Section IX, Contract Forms, or another form acceptable to the Employer. If the performance security furnished by the successful Bidder is in the form of a bond, it shall be issued by a bonding or insurance company that has been determined by the successful Bidder to be acceptable to the Employer. A foreign institution providing a bond shall have a correspondent financial institution located in the Employer's Country.

54.2 Failure of the successful Bidder to submit the above-

mentioned Performance Security and if required in the BDS, the Environmental, Social, Health and Safety (ESHS) Performance Security or sign the Contract shall constitute sufficient grounds for the annulment of the award and forfeiture of the bid security. In that event the Employer may award the Contract to the next lowest evaluated Bidder whose offer is substantially responsive and is determined by the Employer to be qualified to perform the Contract satisfactorily.

**55. Procurement
Related
Complaint**

55.1 The procedures for making a Procurement-related Complaint are as specified in the BDS.

Section II. Bid Data Sheet

A. General													
ITB 1.1	The number of the Invitation for Bids is: HQ/SYS/EC/D-B/ Dadri-Khurja dated 14.06.2017												
ITB 1.1	The Employer is: Dedicated Freight Corridor Corporation of India Limited (DFCCIL)												
ITB 1.1	<p>Name of the ICB is: Design, Supply, Construction, Installation, Testing and Commissioning of 2x25kV AC Electrification, Signalling & Telecommunication, E&M and Associated Works on Design-Build Lump Sum Basis for Dadri-Khurja Section (approximately 47 Route Km of Double Line) of Eastern Dedicated Freight Corridor</p> <p>The identification number of the ICB is: HQ/SYS/EC/D-B/ Dadri-Khurja</p> <p>The names and identification of the Contract Package is as under:</p> <p>System Works Contract Package CP – 105:</p> <p>Design, Supply, Construction, Installation, Testing and Commissioning of 2x25kV AC Electrification, Signalling & Telecommunication, E&M and Associated Works on Design-Build Lump Sum Basis between Dadri Station and Khurja Station (approximately 47 Route Km of Double Line) of Eastern Dedicated Freight Corridor</p> <p>The ICB comprises only 1 (one) number of Contract Package, brief details of which are given in the following table:</p> <table border="1" style="width: 100%; border-collapse: collapse; margin-top: 10px;"> <thead> <tr> <th rowspan="2" style="text-align: center; vertical-align: middle;">Contract Package No.</th> <th colspan="2" style="text-align: center;">Existing Railway KM / DFC Chainage</th> <th rowspan="2" style="text-align: center;">Approximate Total Route Length (Km)</th> <th rowspan="2" style="text-align: center;">Remarks</th> </tr> <tr> <th style="text-align: center;">From</th> <th style="text-align: center;">To</th> </tr> </thead> <tbody> <tr> <td style="text-align: center;">105</td> <td style="text-align: center;"><u>UP Line</u> Km 1367.000 (-7820 m)</td> <td style="text-align: center;">Km 1413.856</td> <td style="text-align: center;">UP - 48.272</td> <td style="text-align: center;">UP Line (Km): Parallel Length: 36.636 Detour Length: 11.636</td> </tr> </tbody> </table>	Contract Package No.	Existing Railway KM / DFC Chainage		Approximate Total Route Length (Km)	Remarks	From	To	105	<u>UP Line</u> Km 1367.000 (-7820 m)	Km 1413.856	UP - 48.272	UP Line (Km): Parallel Length: 36.636 Detour Length: 11.636
Contract Package No.	Existing Railway KM / DFC Chainage		Approximate Total Route Length (Km)	Remarks									
	From	To											
105	<u>UP Line</u> Km 1367.000 (-7820 m)	Km 1413.856	UP - 48.272	UP Line (Km): Parallel Length: 36.636 Detour Length: 11.636									

	<table border="1"> <tr> <td>DN Line Km 1367.900</td> <td>Km 1413.856</td> <td>DN - 46.292</td> <td>DN Line (Km): Parallel Length: 41.956 Detour Length: 4.336</td> </tr> <tr> <td>Km 1411.874</td> <td>Km 1412.660</td> <td>EDFC-WDFC Connecting Line: UP – 0.786 DN – 0.786</td> <td>EDFC-WDFC Connecting Line: UP –786 m DN –786 m</td> </tr> </table> <p>Note: For further details please refer to Part 4: Reference Documents – Site Data.</p>	DN Line Km 1367.900	Km 1413.856	DN - 46.292	DN Line (Km): Parallel Length: 41.956 Detour Length: 4.336	Km 1411.874	Km 1412.660	EDFC-WDFC Connecting Line: UP – 0.786 DN – 0.786	EDFC-WDFC Connecting Line: UP –786 m DN –786 m
DN Line Km 1367.900	Km 1413.856	DN - 46.292	DN Line (Km): Parallel Length: 41.956 Detour Length: 4.336						
Km 1411.874	Km 1412.660	EDFC-WDFC Connecting Line: UP – 0.786 DN – 0.786	EDFC-WDFC Connecting Line: UP –786 m DN –786 m						
ITB 2.1	The Borrower is: Dedicated Freight Corridor Corporation of India Ltd.								
ITB 2.1	The name of the Project is: Eastern Dedicated Freight Corridor Project-1								
ITB 4.3 (f)	The name of Consultant to the Employer is: AECOM Asia Company Ltd. Hong Kong 'AECOM' is providing 'Engineering Consultancy Services' to the Employer, for the Mughalsarai-New Bhaupur and Dadri-Khurja-Ludhiana Sections of Dedicated Freight Corridor.								
ITB 4.3 (g)	The following Project Management Consultant has been appointed for the supervision of the above section: 'TYPASA-ICT-BARSYL JV'								
B. Contents of Bidding Document									
ITB 7.1	For clarification purposes only , the Employer's address is: Dedicated Freight Corridor Corporation of India Limited, Metro Station Building Complex, Pragati Maidan, 4 th Floor, Room No. 432, New Delhi, 110 001, India Attention: Mr. V.P. Singh, Group General Manager /Elect-1/EC Telephone: +91 11 2345 4840 Facsimile number: + 91 11 2345 4842 Electronic mail address: vpsingh@dfcc.co.in The official website of the Employer is www.dfccil.gov.in								
ITB 7.2	Add the following to ITB 7.2: The Bidder is also advised to refer clause 1.9 of General Conditions of								

	Contract																												
ITB 7.4	<p>A Pre-Bid meeting will take place at the following date, time and place:</p> <p>Date: 14.07.2017</p> <p>Time: 15:00 Hrs</p> <p>Place: Conference Room, 4th Floor, Dedicated Freight Corridor Corporation of India Limited, Metro Station Building Complex, Pragati Maidan, New Delhi – 110 001</p> <p>Bidders can provide their request for clarification by mail at vpsingh@dfcc.co.in or in paper copies. In addition they are advised to provide an editable soft copy (MS Word) of the queries raised by them.</p> <p>The Bidders are also advised to use the following format for their queries:</p> <table border="1"> <thead> <tr> <th>Query No.</th> <th>Reference to Bid Document (Clause / Para No. & Page No.)</th> <th>Brief Description of Clause / Para No.</th> <th>Query Raised</th> </tr> </thead> <tbody> <tr> <td>1.</td> <td></td> <td></td> <td></td> </tr> <tr> <td>2.</td> <td></td> <td></td> <td></td> </tr> <tr> <td>3.</td> <td></td> <td></td> <td></td> </tr> <tr> <td>4.</td> <td></td> <td></td> <td></td> </tr> <tr> <td>5.</td> <td></td> <td></td> <td></td> </tr> <tr> <td>etc.</td> <td></td> <td></td> <td></td> </tr> </tbody> </table>	Query No.	Reference to Bid Document (Clause / Para No. & Page No.)	Brief Description of Clause / Para No.	Query Raised	1.				2.				3.				4.				5.				etc.			
Query No.	Reference to Bid Document (Clause / Para No. & Page No.)	Brief Description of Clause / Para No.	Query Raised																										
1.																													
2.																													
3.																													
4.																													
5.																													
etc.																													
ITB 7.6	Minutes of pre-bid meeting shall be intimated only through e-mail to all the bidders, who have purchased the Bid Document from DFCCIL or submitted queries for clarifications. Minutes of pre-bid meeting shall be uploaded on DFCC web site (www.dfccil.gov.in) also.																												
ITB 8.2	Addenda to bidding documents shall be intimated only through e-mail to all the bidders, who have purchased the Bid Document from DFCCIL or submitted queries for clarifications. Addenda to bidding documents shall be uploaded on DFCC web site (www.dfccil.gov.in) also.																												
ITB 10.1	The language of the bid is: English.																												
C1. First Stage Technical Proposals: Preparation																													
ITB 11.1 (b)	Delete paragraph 11.1 (b)																												

ITB 11.1 (i)	<p>The Bidder shall submit, with its First Stage Technical Proposal, the following documents:</p> <p>(a) The bidder shall submit the documents as listed in Annexure-1, section III- Qualification and Evaluation Criteria.</p> <p>(b) In case, the Bidder wishes to replace any specialized sub-contractor(s) already approved by Employer through Pre-qualification process, the Bidder shall submit the details establishing compliance of the proposed specialized sub-contractor with the requirement specified in the Pre-qualification document.</p> <p>(c) Code of Conduct (ESHS)</p> <p>The Bidder shall submit its Code of Conduct that will apply to Contractor's Personnel (as defined in Sub-clause 1.1.2.7 of the GC), to ensure compliance with its Environmental, Social, Health and Safety (ESHS) obligations under the contract. The Code of Conduct submitted by the Bidder should include the methodology to mitigate the risks associated with:-</p> <ul style="list-style-type: none">• Spread of Communicable Diseases.• Sexual Harassment• Gender based Violence• Criminal Activities• Control of Noise Pollution• Sanitation in Labor Camps• Safe disposal of Wastes• Need based training for creating awareness about Safety, Health and Environment <p>In addition, the Bidder shall detail how this Code of Conduct will be implemented. This will include: how it will be introduced into conditions of employment/engagement, what training will be provided, how it will be monitored and how the Contractor proposes to deal with any breaches.</p> <p>The Contractor shall be required to implement the agreed Code of Conduct.</p> <p>(d) Management Strategies and Implementation Plans (MSIP) to manage the (ESHS) risks</p> <p>The Bidder shall submit Management Strategies and Implementation Plans (MSIP) to manage the following key Environmental, Social, Health and Safety (ESHS) risks.</p> <ol style="list-style-type: none">1. Traffic Management Plan to ensure safety of local communities from construction traffic;
---------------------	--

	<p>2. Water Resource Protection Plan to prevent contamination of drinking water</p> <p>3. Boundary Marking and Protection Strategy for mobilization and construction to prevent offsite adverse impacts;</p> <p>4.Strategy for obtaining Consents/Permits prior to the start of works from the State Electricity Board/Empowered Body for granting such permits regarding obtaining of temporary electrical connections, Water connection and Disposal of Waste, permission for quarrying of coarse and fine aggregate, permission to use specific access roads for transportation of oversized and heavy equipment.</p> <p>5.Bio diversity protection Plan</p> <p>6.Strategy for avoidance of any adverse impact on rare species.</p> <p>The Contractor shall be required to submit for approval, and subsequently implement the Contractor’s Environment and Social Management Plan (C-ESMP), in accordance with the Particular Conditions of Contract, sub clause 4.1, that includes the agreed management strategies and implementation Plan described above.</p>
ITB 13.1	Bidders are not permitted to propose any technical alternatives.
ITB 17.1	<p>In addition to the original of the First Stage Technical Proposal, the number of copies is: 3 (three). In addition, 2 (two) soft copies (read only) of the bid shall be submitted.</p> <p>The document submission shall be in spiral / hard bound form only. The Bidders are advised not to submit loose sheets in plastic folders.</p> <p>The Bidders are further advised to machine number all the pages and prepare a table of contents in the beginning of each volume of documents referring the page numbers of the indexed items.</p> <p>The Bidders are also advised to ensure that each paper of the submitted Bid is signed by the legally Authorized Representative of the Bidder.</p>
ITB 17.2	<p>The written confirmation of authorization to sign on behalf of the Bidder shall consist of: Legally authorized power of attorney.</p>
C2. First Stage Technical Proposals: Submission and Opening	
ITB 18.1 & ITB 18.1 (b)	Bidders <u>do not</u> have the option of submitting their First Stage Technical Proposal electronically.

<p>ITB 19.1</p>	<p>For First Stage Technical Proposal, <u>for submission purposes</u> only, the Employer’s address is :</p> <p>Dedicated Freight Corridor Corporation of India Limited, Metro Station Building Complex, Pragati Maidan 4th Floor, Room No. 432, New Delhi, 110001 India</p> <p>Attention: Mr. V.P. Singh, Group General Manager /Elect-1/EC</p> <p>Telephone: +91 11 2345 4840</p> <p>Facsimile number: + 91 11 2345 4842</p> <p>Electronic mail address: vpsingh@dfcc.co.in</p> <p>The deadline for submission of First Stage Technical Proposals is:</p> <p>Date: 17.08.17</p> <p>Time: 15:00 Hrs.</p>
<p>ITB 21.1</p>	<p>The opening of First Stage Technical Proposals shall take place at: Dedicated Freight Corridor Corporation of India Limited, Metro Station Building Complex, Pragati Maidan 4th Floor Conference Hall New Delhi, 110001 India</p> <p>Date: 17.08.2017</p> <p>Time: 15:30 Hrs.</p>
<p>E1. Second Stage Bid Preparation</p>	
<p>ITB 23.1 (b)</p>	<p>Replace the words “Appendix to Contract Agreement” with “Appendix to Tender”.</p> <p>Alternative time for completion proposed, if any, by the Bidders shall not be accepted.</p>
<p>ITB 24.4</p>	<p>Add the following after the ITB 24.4:</p> <p>"In case, the Bidder has proposed to replace any specialized sub-contractor(s) already approved by the Employer through the Pre-qualification process, the Employer shall determine, to its satisfaction that</p>

	the bidder still meets the qualification criteria specified in Section III, Evaluation and Qualification Criteria.”
ITB 27.1 (d)	In Section I, ITB 27.1 (d) has been mentioned twice. Second “27.1 (d)” should be read as 27.1 (e).
ITB 27.1 (e)	Replace ITB Clause No.27.1(e) of Section-I: Instruction to Bidders” with the following: “Confirmation through letter of bid – Two Stage Bidding, Second Stage Bid that the First Stage Technical Proposal, together with the Method Statement for 2x25 kV Electrification, Signalling & Telecommunications, Electrical & Mechanical and Associated Works, details of Personnel, Equipment, Manufacturer Authorization, and the Work Plan etc. submitted by Bidder originally and resubmitted pursuant to the clarifications requested by the Employer in this regard along with Memorandum titled ‘Changes Required Pursuant to First Stage Evaluation’ and subsequent Addendum(s) shall form an integral part of the updated First Stage Technical Proposal. ”
ITB 27.1 (j)	“In case, the Bidder wishes to replace any specialized sub-contractor(s) already approved by the Employer through Pre-qualification process / during First Stage Technical Evaluation, the Bidder shall submit the details establishing compliance of the proposed specialised sub-contractor(s) with the requirement specified in the Pre-qualification document.”
ITB 29.1	Bidder shall quote for the entire Works on a single responsibility basis. The price shall be quoted only in the Letter of Bid-Two Stage Bidding, Second Stage Bid (LOB-SS) Section IV, Bidding Forms, Part 1 of the Bidding Documents.
ITB 29.3	The prices quoted by the Bidder shall be adjustable.
ITB 29.8	Add the following after ITB 29.8: “The bidders may note that this DFCC project being funded by the World Bank, qualifies for exemption from payment of Customs Duty and Excise Duty on goods supplied / intended to be supplied to the project in terms of Government of India’s Notification no. 84/97 – customs dated 11.11.1997 and Central Excise Notification no. 108/95-C E Dated 28.08.1995 (read with all subsequent amendments including amendment dated 01.03.2008) respectively. Service Tax department vide their Notification No. 25/2012-Service Tax

	<p>dated 20.06.2012, has exempted the services by way of construction, erection, commissioning, or installation of original works pertaining to railways. The Bidder shall examine to make his own assessment in regard to service tax liability in the Contract. No separate Service Tax reimbursement will be made by the Employer.</p> <p>However, while quoting the bid price, bidders are advised to ascertain exemptions of custom & excise duty and / or availability of deemed export benefits for goods required as inputs for completion of the Works under the World Bank Funded Projects. The bidders are also advised to ascertain the availability of the custom / excise exemptions for the goods supplied by their subcontractors used as input for the construction of Works.</p> <p>In this regard bidders' attention is also drawn to sub-clause 4.11 of the Particular Conditions.", Section VIII, Part 3 of the Bidding Documents."</p>
ITB 30.1	<p>The currency(ies) of the bid and the payment currency (ies) shall be as described below:</p> <p>a) The prices shall be quoted by the Bidder entirely in Indian Rupees (the name of the currency of Employer's country) and further referred to as "the local currency". A Bidder expecting to incur expenditures in other currencies for inputs to the Works supplied from outside the Employer's country (referred to as "the foreign currency requirements") shall indicate the percentage (s) of the Bid Price in the Appendix to Bid, Section IV, Bidding Forms, Part 1 of Bidding Documents, needed by him for the payment of such foreign currency requirements, limited to no more than three foreign currencies.</p> <p>b) For the purpose of conversion of foreign currency in to local currency i.e. Indian Rupees (INR) or vice versa, Bidders shall use the Reference Rates of Foreign Currency published by Reserve Bank of India (www.rbi.org.in), on the Base Date (28 days prior to the last date of second stage bid submission)</p> <p>In case a particular currency rate is not published by Reserve Bank of India, then the selling rate of such currency shall be taken from the following internet web site on the Base Date: http://www.oanda.com</p> <p>In case the exchange rates are not available on the above website also, then mid-market rate of such currency shall be taken from the alternate web site http://www.xe.com for the same date.</p> <p>c) In respect of procurement of goods and services from off shore sources Indian cost indices shall not apply but wholesale cost index for the</p>

	<p>relevant input of the respective country shall apply. In case a published index for such goods or services is not available, the wholesale prices index of relevant category of the respective country shall be used.</p> <p>The rates of exchange as mentioned above shall apply for all payments under the Contract so that no exchange risk will be borne by the successful bidder.</p>
ITB 30.2	Foreign currency requirements shall be indicated only in respect of those goods and services which the bidder expects to procure from offshore sources.
ITB 31.1	The bid validity period shall be 120 days from last date of bid submission.
ITB 32.1	Bid security shall be submitted with the Second stage bid and shall be INR 25 Million.
ITB 32.3	The bid security shall be an unconditional guarantee issued by a reputed bank from an Eligible country.
ITB 33.1	<p>The bidder shall submit 1 (one) original and 3 (three) copies of the Bid.</p> <p>In addition, one soft copy (read only) of the bid shall also be submitted.</p> <p>The document submission shall be in spiral / hard bound form only. The Bidders are advised not to submit loose sheets in plastic folders.</p> <p>Bidders are advised to initial each paper of their submitted bid.</p> <p>The Bidders are further advised to machine number all the pages and prepare a table of contents in the beginning of each volume of documents referring the page numbers of the indexed items.</p>
ITB 33.2	The written confirmation of authorization to sign on behalf of the Bidder shall consist of: Legally authorized power of attorney
E2. Second Stage Bids: Submission and Opening	
ITB 34.1 & ITB 34.3	Bidders shall not have the option of submitting their bids electronically.
E3. Second Stage Bids: Evaluation and Comparison	
ITB 47.3 (a)	Provisional Sum and Contingencies under this Contract are NIL
ITB 49.3	Replace the words “Appendix to Contract Agreement” with “Appendix to

	<p>Tender”.</p> <p>Add the following at the end of ITB 49.3:</p> <p>“In case, the Bidder has proposed to replace any specialised sub-contractor(s) already approved by Employer through the Pre-qualification process and/or during First Stage Technical Evaluation, the Employer shall determine to its satisfaction that the bidder still meets the qualification criteria specified in Section III, Evaluation and Qualification Criteria.”</p>
<p>ITB 54.1</p>	<p>The Performance Security and Environmental, Social, Health and Safety Performance Security shall be in the form of unconditional guarantee issued by a Scheduled Bank in India (included in the second schedule to Reserve Bank of India Act 1934) or the corresponding financial institution of foreign bank located in India. Bond is not acceptable as Security. The amount required to be paid by the successful Bidder for each of the securities shall be as identified in Appendix to Tender, Part – 3 of the Bid Document of CP - 105.</p>
<p>ITB 55.1</p>	<p>If a Bidder wishes to make a Procurement-related Complaint, the Bidder should submit its complaint, in writing (by the quickest means available, that is either by email or fax), to:</p> <p>For the attention: Mr. V.P. Singh, Title/position: Group General Manager /Elect-1/EC Employer: Dedicated Freight Corridor Corporation of India Limited Email address: vpsingh@dfcc.co.in Fax number: + 91 11 2345 4842</p> <p>In summary, a Procurement-related Complaint may challenge any of the following:</p> <ol style="list-style-type: none"> 1. The terms of the Bidding Documents; and 2. The Employer’s decision to award the contract.

Section III. Evaluation and Qualification Criteria

The purpose of this Section is to establish that the Bidder continues to meet the criteria used at the time of prequalification. It contains all the criteria that the Employer shall use to evaluate bids and qualify Bidders in accordance with ITB 23, ITB 47 and ITB 49. The Bidder shall provide all the information requested in this section as well as in the forms included in Section IV, Bidding Forms.

First Stage Technical Proposals

1. Evaluation

The documents required for submission and evaluation of First Stage Technical Proposal are detailed in Annexure-I of this section. In addition, the following factors shall apply in proposal evaluation.

2. Qualification

2.1 Updation of Information

The Bidder and any subcontractors shall continue to meet the criteria used at the time of prequalification and shall give an undertaking to this effect. The Bidder shall fill up Form number ELI 1.1 and ELI 1.2 included in Section IV, Bidding Forms, Part 1 of Bidding Documents.

2.2 Financial Resources

Using Form No FIN 3.3 in Section IV, Bidding Forms, the Bidder must demonstrate meeting the following cash-flow requirements:

- US \$ 7 (Seven) million for the subject contract

Bidder should meet the above cash flow requirement as indicated in paragraph 3.1 (i) of Section (III) - Eligibility and Qualification criteria of Prequalification Document issued on 22.12.2015 for this bid and as modified, if any, through addendum.

The Audited Financial Statements of the latest completed Financial Years (as required in paragraph 3.1 of Section III - Eligibility and Qualification criteria of Prequalification Document) are to be submitted.

2.3 Personnel

The Bidder shall propose to arrange the following minimum key personnel during the execution of work:

SN	Key Position	Minimum Qualifying Requirement		
		Total Work Experience (years)	Experience in Similar Works (years)	Minimum Education Qualification
1.	Project Director**	20	7	B.E. /B. Tech or Equivalent
2.	Sr. Design Engineer* (Signalling)	15	5	B.E. (Electrical / Electronics) or Equivalent
3.	Sr. Design Engineer* (Telecommunication)	15	5	B.E. (Electrical / Electronics / Telecommunication) or Equivalent
4.	Sr. Design Engineer (OHE)	15	5	B.E. (Electrical / Mechanical) or Equivalent
5.	Sr. Design Engineer* (2x25 kV Sub Station)	15	5	B.E. (Electrical) or Equivalent
6.	Sr. Design Engineer* (SCADA)	15	5	B.E. (Electrical / Electronics) or Equivalent
7.	System Integrator*	15	5	B.E. /B. Tech or Equivalent
8.	Interface Manager	15	7	B.E. /B. Tech or Equivalent
9.	Project Manager (Signalling)	15	5	B.E. /B. Tech or Equivalent
10.	Project Manager (Telecommunication)	15	5	B.E. /B. Tech or Equivalent

SN	Key Position	Minimum Qualifying Requirement		
		Total Work Experience (years)	Experience in Similar Works (years)	Minimum Education Qualification
11.	Project Manager (OHE)	15	5	B.E. /B. Tech or Equivalent
12.	Project Manager * (Traction Sub Station 2x25 kV & SCADA)	15	5	B.E. /B. Tech or Equivalent
13.	Planner & Scheduler	15	5	B. Tech. or any other Science Graduate (should be well conversant with Primavera or similar software)
14.	Quality Control Expert	15	5	B.E. /B. Tech or Equivalent
15.	Safety & Health Expert***	15	5	B.E. /B. Tech or Equivalent with Specialization/ additional qualification in EHS related field.
16.	RAMS Expert	15	5	B.E. /B. Tech or Equivalent with Diploma/ Specialization in RAMS.
17.	Train Management System Expert	15	5	B.E. /B. Tech or Equivalent
18.	Environmental Expert***	15	5	B.E./B. Tech or Equivalent with Specialization /

SN	Key Position	Minimum Qualifying Requirement		
		Total Work Experience (years)	Experience in Similar Works (years)	Minimum Education Qualification
				additional qualification in Environment related field
19.	Social Expert***	15	5	Master's degree in Social Work or equivalent

*Minimum 3 (three) years outside India experience in at least one Project

**Minimum 5 (five) years outside India experience in at least two Projects

*** He/she should have worked as a sole expert for large scale Infrastructure projects. Experience in Environment / Safety / Social Risk Assessment, resettlement and rehabilitation and Management plans related to similar project preferably Railways.

The Bidder shall provide details of the proposed personnel and their experience records in the Form number PER -1 and PER - 2 included in Section IV, Bidding Forms.

Note:

The Bidders are advised NOT to submit more than one CV against each of the above mentioned key positions. In case more than one CV is submitted for any key position, such additional CV(s) shall not be considered for evaluation purposes and only the first CV in the bidding document would be considered for evaluation.

2.4 Equipment

The Bidder shall demonstrate that it will have access to essential equipment /plants during the execution of Works. Capacity and number of machines shall be commensurate with the Works program submitted by the Bidder to enable him to finish the work in stipulated time. The Bidder shall provide

ownership/renting/leasing/ arrangement details of proposed items of equipment using Form number EQU in Section IV of Bidding Document.

SN	Name of Equipment / Software	Number(s)*
1.	Self-propelled work train(s)	As required*
2.	Crane(s) for OHE structure erection work	As required*
3.	Auger(s) for mechanized casting of OHE foundations	As required*
4.	Weigh Batch Mixing Plant(s) for Concreting	As required*
5.	Self-propelled OHE inspection cum maintenance car for OHE adjustment and final profile checking	As required*
6.	Software for Traction Simulation Studies**	1
7.	Cable Trencher	As required*
8.	Trenchless Cabling Equipment	As required*
9.	Auto Fusion Splicing Machine	As required*

*Appropriate number(s) to be filled by the Bidder based on the methodology.

**The Bidder shall also be required to submit a certificate, from the Developer/Vendor of the Software, that the Simulation Software has been validated by comparing its result to actual field measurements on a 2 x 25 kV Traction supply system.

Note:

The above ‘List of Equipment /Plants’ is indicative only. The Bidders’ are advised to refer to Sub-Clause 4.17 [Contractor’s Equipment] of the Conditions of Contract pursuant to which the Contractor shall be responsible for all Contractors’ Equipment.

2.5 Subcontractors and Suppliers

Subcontractors for major items of supply or services identified in the prequalification document must continue to meet the minimum criteria specified therein for each item.

The Bidder shall demonstrate in its proposal clearly the work and value (in terms of percentage of the approximate total value of the Contract) of that work to be carried out by its main subcontractors, including its proposed designer if the Design is not to be carried out in-house.

Where the Bidder intends to utilize materials, equipment & plants and services including design services procured from subcontractors / suppliers,

it should outline such materials and equipment to be procured, in Form SUP, provided in Section IV.

In the case of a Bidder who offers to supply and/or install plant and equipment/ component/ software under the contract that the Bidder does not manufacture or otherwise produce and/or install, the Bidder shall provide the manufacturer's authorization, using the Form Manufacturer's Authorization provided in Section IV, Part 1 showing that the Bidder has been duly authorized by the manufacturer or producer of the related plant and equipment or component to supply and/or install that item in the Employer's country. The Bidder is responsible for ensuring that the manufacturer or producer complies with the requirements of ITB 4 and 5.

3. Second Stage Bid

3.1. Evaluation

The evaluation of the Second Stage bid shall be carried out in accordance with the provisions of ITB 47. Bidders shall submit Second Stage Bid as per the Form - LOB –SS Bidding Forms-Section IV.

3.2. Evaluation of non-material non conformities as per ITB 43.3

Non material non conformities related to the Bid Price will be evaluated considering price implication for the same based upon current market rate/ rate analysis. Decision of employer regarding evaluation of nonmaterial non conformities shall be final and binding on the bidder.

3.3 Time Schedule for Completion of Works:

The designated period for the completion and taking over the entire Works shall be 640days from the Commencement Date, as indicated with further details in Para 8.2, Appendix to Tender, Part 3, Section VIII of these Bidding Documents. Bidders shall confirm that their First Stage Technical Proposals and subsequently, their Second Stage Bids are based on this Time Schedule for Completion. No credit of any kind will be given in the evaluation of Technical Proposals and Second Stage Bids to a Proposal and/ or a Bid offering to complete the Works earlier than this designated period. However, Technical Proposals and Second Stage Bids offering to complete the Works later than this designated period shall be rejected by the Employer.

Annexure- I

Documents Required For Bid Submission and Evaluation

of

First Stage Technical Proposal

1 Type of Contract

First Stage Technical Proposals, followed by Second Stage Bids, are being invited for a Lump-Sum Contract for Design and Construction, based on the Employer's Requirements. The detailed design of all components of the freight railway will be carried out by the Contractor based on the technical standards and specifications prescribed in Part 2- Employers' Requirements. The Conditions of Contract will be based on the "Conditions of Contract for Plant and Design-Build for Electrical and Mechanical Plant, and for Building and Engineering Works Designed by the Contractor" First Edition 1999 published by the Fédération Internationale des Ingénieurs-Conseils (FIDIC).

2 Documents Required for First Stage Technical Proposal

The First Stage Technical Proposal will comprise of the following documents including the documents required as per Clause ITB 11:

2.1 General Submittal

TO BE SUBMITTED				
	Documents	By Sole Bidder	By JV	Remarks
(a)	Proposal Letter Two Stage Bidding: First Stage Technical Proposal – (Form – LOB –FS, Bidding Forms-Section IV)	√	√	
(b)	Power of Attorney to submit Bid (Form POA-1, Bidding Forms-Section IV);	√	√	
(c)	Power of Attorney to Authorized Representative of Joint Venture (Form POA-2, Bidding Forms-Section IV);	×	√	
(d)	Proforma Letter of Participation from Each Member of Joint Venture (Form LOP, Bidding Forms-Section IV);	×	√	To be submitted by each member of the JV

TO BE SUBMITTED				
	Documents	By Sole Bidder	By JV	Remarks
(e)	Memorandum of Understanding (Form MOU – Bidding Forms-Section IV);	×	√	
(f)	Bidder Information (Form ELI 1.1 – Bidding Forms-Section IV);	√	√	
(g)	Bidder Party Information (Form ELI 1.2 – Bidding Forms-Section IV);	Only by each proposed Specialized Subcontractor	By each member of the JV and each proposed Specialized Subcontractor	Form ELI-1.2, is also to be submitted for each proposed Specialized Subcontractors.
(h)	Environment, Social, Health and Safety Performance Declaration (Form CON- 3– Bidding Forms-Section IV);	√	√	Form CON-3, is also to be submitted for each proposed Specialized Subcontractors.
(i)	Undertaking as required vide para 2.1 Section III Evaluation and Qualification Criteria (FORM-UND, Bidding Forms-Section IV);	√	√	
(j)	Financial Resources (FIN 3.3 – Bidding Forms-Section IV);	√	√	To be submitted for each member of the JV
(k)	Current Contract Commitments / Works in Progress (Form CCC, Bidding Forms-Section IV);	√	√	To be submitted for each member of the JV
(l)	Schedule of Suppliers (Form SUP – Bidding Forms-Section	√	√	

TO BE SUBMITTED				
	Documents	By Sole Bidder	By JV	Remarks
	IV);			
(m)	Undertaking of Copyright (Form CU –Bidding Forms-Section IV);	√	√	
(n)	Manufacturers' Authorisation (FORM-MA, Bidding Forms-Section IV)	√	√	To be submitted by all authorised manufacturers proposed by the bidder
(o)	Technical Submittals pursuant to clause 2.2 of Annexure-I of Section III, Evaluation and Qualification Criteria.	√	√	

2.2 Technical Submittal

1) Methods Statement

The Bidder shall submit a methods statement which demonstrates the Bidder's understanding of the Project and comprehension of the Works involved. In this methods statement, the Bidder shall submit *inter alia* a detailed plan for design, layout, installation, construction, testing & commissioning and handing over the completed Works to the Employer in strict compliance with the Contract requirements. This shall correspond to Site organization, Contractor's equipment, construction schedule and Work Plan being submitted by the Bidder as a part of bid documents.

2) Organization and Management

The Bidder shall submit an organization chart identifying the management and reporting structure for key positions and all site teams. The Bidder shall submit a commentary that describes the roles and responsibilities of the various key positions in the organization structure, the minimum qualifications, channels of communication, organization they come from and how this organization structure will manage the execution of the works within the scheduled period. The names and CV's of key staff in the

organization chart shall be included, and referenced to forms **PER-1 & 2** in Section IV, Bidding Forms.

3) Work Plan

The Bidder shall submit a Work Plan which shall indicate how the Bidder intends to organize and carry out the Works, achieve Stages and complete the whole of the Works by the appropriate Key Dates. The Work Plan shall be prepared in terms of weeks from the Date of Commencement of Works, taking D as the Commencement Date and other time schedules marked in D+ format. Bidders are required to provide details of Contractor's Equipment in **Form EQU** as per Bidding Form included in Section IV.

(Refer to Explanatory Note 1 at the end of this Section)

4) Documents for Safety, Quality and Environmental Plans

The Bidder shall submit the following documents, which shall demonstrate clearly the Bidder's proposals for achieving effective and efficient Safety, Quality and Environment protection procedures.

- a) **Outline Safety Plan**
- b) **Outline Quality Plan**
- c) **Outline Environmental Plan**
- d) **ESHS Management Strategies and Implementation Plans**
- e) **Code of Conduct: Environmental, Social, Health and Safety (ESHS)**

(Refer to Explanatory Note 2 at the end of this Section)

5) Performance Parameters Compliance

The Bidder shall submit details of compliance with the Employers' Requirements as listed in Part 2 of bidding document. This shall be done in a tabular format on a section by section basis and detail how the compliance is achieved.

Explanatory Note No. 1

Reference Paragraph 2.2 (3) Work Plan: Requirements of Work Plan

- (1) The Work Plan shall show how the Bidder proposes to organize and carry out the Works and to achieve Stages and complete the whole of the Works by the given Key Dates/Milestones. This may be in the form of an Excel spread sheet/ Primavera or similar program output.
- (2) The Work Plan shall follow the instructions given in **Part 2, Section VI, “Employer’s Requirements/ Volume 1: General Specification, Chapter 4, PROJECT PROGRAM REQUIREMENTS”**
- (3) The Work Plan shall show achievement of all Key Dates and Works Area Access Dates. The Works Programme shall also show Milestones, but the Milestones shall not be taken as imposing any constraints that in any way affect the logic or limit any other dates in the Programme.
- (4) The Works Plan shall take into account the Bidder’s proposed Design Submission Programme and should
 - (a) indicate, wherever possible, dates and periods relating to interfaces with and between others including dates for submission of further documents required by the Contract and periods for their acceptance.
 - (b) be consistent with the overall Work Plan and in accordance with the Employer's Requirements;
 - (c) make adequate allowance for periods of time for review by authorities whose approval is necessary;
 - (d) include a schedule identifying, describing, cross-referencing and explaining the Design packages and submissions which the Bidder intends to submit;
 - (e) take due account of the design co-ordination interface periods during which the Contractor shall be required to undertake and complete all aspects of design co-ordination with other consultants engaged in the review of the design of the Project such design will be compatible and coordinated with others and allowing adequate time for the Employer’s assessments and decisions.
- (5) The Work Plan shall contain sufficient detail to assure the Employer of the feasibility of the plan and approach proposed by the Bidder.
- (6) The Bidder should have regard to the possibility that during the bid evaluation period the Work Plan may be developed into a Programme which, in the event of award, would be the initial submission of the Works Programme. To facilitate this

process the Bidder shall, in the preparation of the Work Plan, take due account of the provisions of the Employer's Requirements in so far as they concern the Work Plan.

- (7) The Work Plan shall be accompanied by a narrative statement that shall describe Programme activities, assumptions and logic, and highlight the Bidder's perception of the major constraints and critical areas of concern in the organization, construction and completion of the Works. This narrative statement shall also indicate which elements of the Works the Bidder intends to carry out off-Site and/or outside India with details of the proposed locations of where any such work is to be carried out, the facilities available and any third party undertakings the Bidder may have in this regard. In particular the Bidder must state the assumptions made in respect of the interfaces with the Employer, other contractors and third parties both in detail and time, and any requirements for information on matters which would affect his works.
- (8) All programmes shall include design, procurement periods, major material, on site, offsite, off shore production/ prefabrication, temporary construction, interface and periods for System wide, utility and adjacent contractors, testing and commissioning and integrated testing along with any other training and trial running information.
- (9) The proposed submission of the Work Plan and Design Submission Programme shall not, in any event, be construed as a submission under Clause 8.3 (Programme) of the General Conditions.

Explanatory Note No. 2

Reference Paragraph 2.2(4) Annexure-I - Documents for Safety, Quality and Environmental Plans

OUTLINE SAFETY PLAN

The Bidder shall submit as part of his bid an Outline Safety Plan which shall contain sufficient information to demonstrate clearly the Bidder's proposals for achieving effective and efficient safety procedures. The Outline Safety Plan should include an outline of the safety procedures and regulations to be developed and the mechanism by which they will be implemented for ensuring safety as required as per the Employer's Requirements - Construction and Sub-Clause 4.8 and 6.7 of the Conditions of Contract.

The Outline Safety Plan shall be headed with a formal statement of policy in relation to safety and shall be sufficiently informative to define the Bidder's safety plans and set out in summary an adequate basis for the development of the Site Safety Plan to be submitted in accordance with Sub-Clause 4.8 and 6.7 of the Conditions of Contract including a testing and commissioning strategy/plan for the whole of the Works.

OUTLINE QUALITY PLAN

The Bidder shall submit as part of his bid an Outline Quality Plan which shall contain sufficient information to demonstrate clearly the Bidder's proposals for achieving effective and efficient Quality Assurance and Control System. The Plan should include an outline of the procedures and regulations to be developed and the mechanism by which they will be implemented for ensuring Quality as required in terms of the Employer's Requirements. It shall also include an outline of procedures, verification and validation for all tests and materials for all the Works being done by him under this Contract.

OUTLINE ENVIRONMENTAL PLAN

The Bidder shall submit as part of his bid an Outline Environmental Plan illustrating the intended means of compliance with the requirements of Part 2 Section-VI, Employer's Requirement, Volume-1: General Specifications, Chapter -15, Appendix 6 "ENVIRONMENTAL PROTECTION REQUIREMENTS" to the Employer's Requirements and setting out in summary form an adequate basis for the development of the more detailed document to be submitted under Sub-Clause 4.18 of the Conditions of Contract. The Outline Environmental Plan shall contain sufficient information to demonstrate clearly the proposed method of achieving the Bidder's environmental objectives with regard to the requirement of the Contract.

The Outline Environmental Plan shall be headed with a formal statement of policy in relation to environmental protection and shall be sufficiently informative to define the Bidder's environmental plans and set out in summary an adequate basis for the submission

of a detailed and comprehensive site environmental quality management plan to be submitted in accordance with Sub-Clause 4.18 of the Conditions of Contract.

The Outline Plan shall include the methods and procedures for the Environmental Impact Assessment to be performed under the Contract.

ESHS Management Strategies and Implementation Plans

(ESHS-MSIP)

The Bidder shall submit comprehensive and concise Environmental, Social, Health and Safety Management Strategies and Implementation Plans (ESHS-MSIP) as required by ITB 11.1 (i) of the Bid Data Sheet. These strategies and plans shall describe in detail the actions, materials, equipment, management processes etc. that will be implemented by the Contractor, and its subcontractors.

In developing these strategies and plans, the Bidder shall have regard to the ESHS provisions of the contract including those as may be more fully described in the following:

1. The Works Requirements as described in Section VI;
2. Environmental and Social Impact Assessment (ESIA);
3. Environmental Management Framework (EMF);
4. Resettlement Action Plan (RAP);
5. DFCC SHE Manual
6. Traffic Management Plan to ensure safety of local communities from construction traffic;
7. Water Resource Protection Plan to prevent contamination of drinking water
8. Boundary Marking and Protection Strategy for mobilization and construction to prevent offsite adverse impacts; Strategy for obtaining Consents/Permits prior to the start of works from the State Electricity Board/Empowered Body for granting such permits regarding obtaining of temporary electrical connections, Water connection and Disposal of Waste, permission for quarrying of coarse and fine aggregate, permission to use specific access roads for transportation of oversized and heavy equipment.

Code of Conduct: Environmental, Social, Health and Safety (ESHS)

The Bidder shall submit the Code of Conduct that will apply to the Contractor's employees and subcontractors as required by ITB 11.1 (i) of the Bid Data Sheet. The Code of Conduct shall ensure compliance with the ESHS provisions of the contract, including those as may be more fully described in the following:

1. The Works Requirements described in Section VI;
2. Environmental and Social Impact Assessment (ESIA);
3. Environmental Management Framework (EMF);
4. Resettlement Action Plan (RAP);

The Code of Conduct submitted by the Bidder should include the methodology to mitigate the risks associated with:-

- Spread of Communicable Diseases.
- Sexual Harassment
- Gender based Violence
- Criminal Activities
- Control of Noise Pollution
- Sanitation in Labor Camps
- Safe disposal of Wastes
- Need based training for creating awareness about Safety, Health and Environment

In addition, the Bidder shall submit an outline of how this Code of Conduct will be implemented. This will include: how it will be introduced into conditions of employment/engagement, what training will be provided, how it will be monitored and how the Contractor proposes to deal with any breaches.

IV. Bidding Forms

Table of Contents

Form LOB –FS	61
Proposal Letter – Two Stage Bidding, First Stage Technical Proposal	61
Form UND.....	63
Undertaking Form	63
Form ELI 1.1.....	64
Bidder Information Sheet.....	64
Form ELI 1.2.....	65
Party to Bidder Information Sheet.....	65
Form CON-3.....	66
Environmental, Social, Health, and Safety Performance Declaration.....	66
Form MOU.....	68
Draft Memorandum of Understanding (MoU) for Joint Venture Participation.....	68
Form LOP	74
Proforma Letter of Participation from Each Member of Joint Venture (JV).....	74
Form POA -1.....	77
Power of Attorney to submit the Bid.....	77
Form POA -2.....	79
Power of Attorney to the Authorized Representative of Joint Venture (JV).....	79
Form CCC.....	82
Current Contract Commitments / Works in Progress	82
Form FIN 3.3.....	84
Financial Resources	84
Form SUP.....	85
Proposed Subcontractors and Suppliers for Major Items of Works	85
Form CU.....	86
Copyright Undertaking.....	86
Form MA.....	87
Manufacturer’s Authorization	87
Form EQU.....	88
Contractor’s Equipment.....	88
Personnel#	90
Form PER-2.....	96
Resume of Proposed Personnel.....	96

Form - LOB –SS	97
Letter of Bid – Two Stage Bidding, Second Stage Bid.....	97
Appendix to Bid	100
Annexure I of Appendix to Bid.....	102
Form BS.....	119
Form of Bid Security.....	119
PRICE SCHEDULES	121
PRICE SCHEDULE 1.0.....	121
Price Schedule 2.0 Apportionment of Contract Price for Payments According to Cost Centres.....	123
PRICE SCHEDULE 2.1.....	124
PRICE SCHEDULE 2.1.1.....	125
PRICE SCHEDULE 2.1.2.....	127
PRICE SCHEDULE 2.1.3.....	130
PRICE SCHEDULE 2.1.4.....	132
PRICE SCHEDULE 2.1.5.....	134
PRICE SCHEDULE 2.1.6.....	135
PRICE SCHEDULE 2.1.7.....	137
PRICE SCHEDULE 2.1.8.....	138
PRICE SCHEDULE 2.2.....	139
PRICE SCHEDULE 2.2.1.....	140
PRICE SCHEDULE 2.2.2.....	141
PRICE SCHEDULE 2.2.3.....	144
PRICE SCHEDULE 2.2.4.....	147
PRICE SCHEDULE 2.2.5.....	150
PRICE SCHEDULE 2.2.6.....	152
PRICE SCHEDULE 2.2.7.....	153
PRICE SCHEDULE 2.3.....	154
PRICE SCHEDULE 2.3.1.....	155
PRICE SCHEDULE 2.3.2.....	157
PRICE SCHEDULE 2.3.3.....	159
PRICE SCHEDULE 2.3.4.....	161
PRICE SCHEDULE 2.3.5.....	163
PRICE SCHEDULE 2.3.6.....	164
PRICE SCHEDULE 2.3.7.....	165
PRICE SCHEDULE 2.3.8.....	166

Form LOB –FS

(Para 2.1(a), Annexure-I; Section III)

Proposal Letter – Two Stage Bidding, First Stage Technical Proposal

Date: _____

ICB No.: HQ/SYS/EC/D-B/Dadri-Khurja

Invitation for Bid No.: _____

To: _____

Subject: Design, Supply, Construction, Installation, Testing and Commissioning of 2x25kV AC Electrification, Signalling & Telecommunication, E&M and Associated Works on Design-Build Lump Sum Basis for Dadri-Khurja Section (approximately 47 Route Km of Double Line) of Eastern Dedicated Freight Corridor

Contract Package No.: 105

Dear Sir

We, the undersigned, declare that:

- (a) We have examined and have no reservations to the bidding document, including Addenda issued in accordance with Instructions to Bidders (ITB)-8_;
- (b) We offer to undertake the procurement of Works under the above named Contract in conformity with the bidding document.
- (c) We, including any subcontractors or manufacturers for any part of the contract, have or will have nationalities from eligible countries, in accordance with ITB-4.2;
- (d) We, including any subcontractors or manufacturers for any part of the contract, do not have any conflict of interest in accordance with ITB-4.3;
- (e) We are not submitting more than one First Stage Technical Proposal for each Contract in this bidding process as a Bidder, either individually or as a partner in a joint venture, in accordance with ITB-4.3.
- (f) We, along with any of our subcontractors, suppliers, consultants, manufactures, service provider for any part of the contract, are not subject to and not controlled by any entity or individual that is subject to, a temporary suspension or a debarment imposed by a member of the World Bank Group or a debarment imposed by the World Bank Group

in accordance with the Agreement for Mutual Enforcement Debarment Decisions between the World Bank and other development banks. Further, we are not ineligible under the Employer’s country laws or other regulations or pursuant to a decision of the United Nations Security Council.

- (g) We are not a government owned entity/ We are a government owned entity but meet the requirements of ITB-4.5¹
- (h) We further undertake, if invited to do so by you, and at our own cost, to attend a clarification meeting at a place of your choice, for the purpose of reviewing our First Stage Technical Proposal and duly noting all amendments and additions thereto, and noting omissions there from that you may require.
- (i) We further undertake, upon receiving your written invitation, to proceed with the preparation of our Second Stage bid, updating our First Stage Technical Proposal in accordance with the requirements from the Memorandum of the clarification meeting, and completing our Second Stage bid for performing the activities of the above noted Works, in accordance with our updated First Stage Technical Proposal, and with ITB Clause 27.
- (j) We have paid, or will pay the following commissions, gratuities, or fees with respect to the bidding process or execution of the Contract:

Name of Recipient	Address	Reason	Amount

(If none has been paid or is to be paid, indicate “none”)

Signature: _____

Name _____ signed in the capacity of _____ duly authorized to sign the bid for and on behalf of _____

 Date: [insert day, month, year]

¹ Delete one of the two as appropriate.

(Para 2.1 (i) of Annexure-1, Section III)

Subject: Design, Supply, Construction, Installation, Testing and Commissioning of 2x25kV AC Electrification, Signalling & Telecommunication, E&M and Associated Works on Design-Build Lump Sum Basis for Dadri-Khurja Section (approximately 47 Route Km of Double Line) of Eastern Dedicated Freight Corridor

Contract Package No.: 105

Undertaking Form

We, M/s _____ (insert name of the bidder) hereby undertake and confirm that we and our sub-contractors _____ (insert the name of sub-contractor(s)) continue meeting the criteria used at the time of prequalification.

Signature.....

NameSigned in the capacity of duly authorized to sign the bid for and on behalf of

Date: [insert day, month, year]

(para 2.1 (f) of Annexure-1, Section III)

Bidder Information Sheet

Date: _____
ICB No. and Title: _____
Invitation for Bid No.: _____
Contract Package Name and Number: _____
Page _____ of _____ pages

1. Bidder's Legal Name:
2. In case of JVA, legal name of each party:
3. Bidder's actual or intended Country of Registration:
4. Bidder's Year of Registration:
5. Bidder's Legal Address in Country of Registration:
6. Bidder's Authorized Representative Information Name: Address: Telephone/Fax numbers: Email Address:
7. Attached are copies of original documents of: <input type="checkbox"/> Articles of Incorporation or Registration of firm named in 1, above, in accordance with ITB Sub-Clauses 4.1 and 4.2. <input type="checkbox"/> In case of JVA, letter of intent to form JVA including a draft agreement, or JVA agreement, in accordance with ITB Sub-Clauses 4.1 and 11.1(i) Single Stage Bidding or 11.1(g) Two Stage Bidding. <input type="checkbox"/> In case of government owned entity from the Employer's country, documents establishing legal and financial autonomy and compliance with the principles of commercial law, in accordance with ITB Sub-Clause 4.5.

Please note that a written authorization needs to be attached to this sheet as required by ITB 21.2 Single Stage Bidding) or ITB 17.2 Two Stage Bidding

(para 2.1 (g) of Annexure-1, Section III)

Party to Bidder Information Sheet

(to be completed for each member of Bidder's JV and each Specialized Subcontractor of every Bidder)

Date: _____
ICB No. and Title: _____
Invitation for Bid No.: _____
Contract Package Name and Number: _____
Page _____ of _____ pages

1. Bidder's Legal Name:
2. Bidder's Party/Specialized Subcontractor Legal name:
3. Bidder's Party/Specialized Subcontractor Country of Registration:
4. Bidder's Party/Specialized Subcontractor Year of Registration:
5. Bidder's Party/Specialized Subcontractor Legal Address in Country of Registration:
6. Bidder's Party/Specialized Subcontractor Authorized Representative Information Name: Address: Telephone/Fax numbers: Email Address:
7. Attached are copies of original documents of: <input type="checkbox"/> Articles of Incorporation or Registration of form named in 2, above. <input type="checkbox"/> In case of government owned entity from the Purchaser's country, documents establishing legal and financial autonomy and compliance with the principles of commercial law, in accordance with ITB Sub-Clause 4.5.

Environmental, Social, Health, and Safety Performance Declaration

(para 2.1 (h) of Annexure-1, Section III)

[The following table shall be filled in for the Bidder, each member of a Joint Venture and each Specialized Subcontractor]

Bidder's Name: *[insert full name]*

Date: *[insert day, month, year]*

Joint Venture Member's or Specialized Subcontractor's Name: *[insert full name]*

RFB No. and title: *[insert RFB number and title]*

Page *[insert page number]* of *[insert total number]* pages

Environmental, Social, Health, and Safety Performance Declaration in accordance with Section III, Qualification Criteria, and Requirements			
<input type="checkbox"/> No suspension or termination of contract: An employer has not suspended or terminated a contract and/or called the performance security for a contract for reasons related to Environmental, Social, Health, or Safety (ESHS) performance since 1 st January 2012.			
<input type="checkbox"/> Declaration of suspension or termination of contract: The following contract(s) has/have been suspended or terminated and/or Performance Security called by an employer(s) for reasons related to Environmental, Social, Health, or Safety (ESHS) performance since 1 st January 2012. Details are described below:			
Year	Suspended or terminated portion of contract	Contract Identification	Total Contract Amount (current value, currency, exchange rate and US\$ equivalent)
<i>[insert year]</i>	<i>[insert amount and percentage]</i>	Contract Identification: <i>[indicate complete contract name/ number, and any other identification]</i> Name of Employer: <i>[insert full name]</i> Address of Employer: <i>[insert street/city/country]</i> Reason(s) for suspension or termination: <i>[indicate main reason(s)]</i>	<i>[insert amount]</i>
<i>[insert year]</i>	<i>[insert amount and percentage]</i>	Contract Identification: <i>[indicate complete contract name/ number, and any other identification]</i> Name of Employer: <i>[insert full name]</i> Address of Employer: <i>[insert street/city/country]</i>	<i>[insert amount]</i>

		Reason(s) for suspension or termination: <i>[indicate main reason(s)]</i>	
...	...	<i>[list all applicable contracts]</i>	...
Performance Security called by an employer(s) for reasons related to ESHS performance			
Year	Contract Identification		Total Contract Amount (current value, currency, exchange rate and US\$ equivalent)
<i>[insert year]</i>	Contract Identification: <i>[indicate complete contract name/ number, and any other identification]</i> Name of Employer: <i>[insert full name]</i> Address of Employer: <i>[insert street/city/country]</i> Reason(s) for calling of performance security: <i>[indicate main reason(s)]</i>		<i>[insert amount]</i>

(para 2.1(e), Annexure 1, Section III)

Draft Memorandum of Understanding (MoU) for Joint Venture Participation

(For Bidders in India to be executed on non-judicial Stamp paper of appropriate value. For Bidders from outside India, to be executed according to the applicable laws in the Bidder's country and by taking into account the Notes shown below.)

This agreement cum memorandum of understanding is made on theday ofmonth.....year

BETWEEN / AMONG²

M/s _____ having its registered office at _____ (hereinafter referred to as) acting as the authorized representative of the first part,

AND

M/s _____ having its registered office at _____ (hereinafter referred to as) in the capacity of a Joint Member of the second/³ other⁴ part;

AND

M/s _____ having its registered office at _____ (hereinafter referred to as) in the capacity of a Joint Member of the third⁵ part;

AND

M/s _____ having its registered office at _____ (hereinafter referred to as) in the capacity of a Joint Member of the fourth part.

The expressions of _____ and _____ and _____ and⁶ shall wherever the context admits, mean and include _____

² In case of only two members forming the Joint Venture, (i) delete the word "AMONG" else delete "BETWEEN"; and

³ (ii) delete the words "second/" and (iii) delete the next two paragraphs.

⁴ Delete the words "/other " in case of more than two members forming the Joint Venture

⁵ In case of three members forming the Joint Venture delete the next paragraph.

⁶ Delete the last words "and _____ and _____" in case of only two members forming the Joint Venture and delete the last words "and _____" in case of only three members forming the Joint Venture.

their respective legal representatives & successors and permitted assigns and shall collectively be referred to as “the Parties” and individually as “the Party”

WHEREAS:

Dedicated Freight Corridor Corporation of India Limited (DFCC) [hereinafter referred to as “Client”] has invited bids for _____ “[Insert name of Contract Package and No.]”

NOW, THEREFORE, THE PARTIES AGREE AS FOLLOWS:

1. The following documents shall be deemed to form and be read and construed as an integral part of this MOU.
 1. Notice for Invitation for Bids, and
 2. Bidding documents as issued by Dedicated Freight Corridor Corporation of India Limited (DFCC)
 3. Any Addendum/Corrigendum issued by DFCC
 4. The bid submitted on our behalf jointly by the authorized representative.
2. The ‘Parties’ have studied the documents and have agreed to participate in submitting a ‘bid’ jointly.
3. M/s _____ shall be the authorized representative of the JV for all intents and purpose and shall represent the Joint Venture in its dealing with the Client. For the purpose of submission of bid proposals, the parties agree to nominate _____ as the authorized representative duly authorized to sign and submit all documents and subsequent clarifications, if any, to the Client. However M/s _____ shall not submit any such proposals, clarifications or commitments before securing the written clearance of the other Member(s) which shall be expeditiously given by M/s _____ and M/s _____ and M/s _____ to M/s _____.⁷
4. The ‘Parties’ have resolved that the distribution of responsibilities and their proportionate share in the Joint Venture is as under:

Joint Venture Member(s)	Financial Share (%)	Responsibilities
(i)		
(ii)		
(iii)		

⁷ Delete the last words “and M/s _____ and M/s _____” in case of only two members forming the Joint Venture and delete the last words “M/s _____” in case of only three members forming the Joint Venture.

Joint Venture Member(s)	Financial Share (%)	Responsibilities
(iv) ⁸		

5. **JOINT AND SEVERAL RESPONSIBILITY**

The Parties undertake that all partners shall be jointly and severally liable to the Client in the discharge of all the obligations and liabilities in terms of the Bidding Documents issued by the Client and for the execution of contract in terms of the Contract with the Client, if awarded to the Joint Venture.

6. **ASSIGNMENT AND THIRD PARTIES**

The parties shall cooperate throughout the entire period of this MOU on the basis of exclusivity and none of the Parties shall make arrangement or enter into agreement either directly or indirectly with any other party or group of parties on matters relating to the Project except with prior written consent of the other party.

7. **EXECUTIVE AUTHORITY**

The said Joint Venture shall act through its authorized representative who shall have the authority to conduct all business for and on behalf of any and all the partners of the Joint Venture during the bidding process and, in the event the Joint Venture is awarded the Contract, during contract execution.

The management structure for the project shall be prepared by mutual consultations to enable completion of project to quality requirements of the Contract within permitted cost and time.

8. **GUARANTEES**

Till the award of the work, the authorized representative shall furnish bid guarantees to the Client on behalf of the Joint Venture which shall be legally binding on all the Members of the Joint Venture.

9. **BID SUBMISSION**

Each Party shall bear its own cost and expenses for preparation and submission of the bid and all costs until conclusion of a contract with the Client for the Project. Common expenses shall be shared by the parties in the ratio of their actual participation.

10. **INDEMNITY**

Each Party hereto agrees to indemnify the other Party(ies), against its respective part in case of breach/default, of any liabilities sustained by the Joint Venture.

⁸ Delete the last two rows in case of only two members forming the Joint Venture and delete the last row in case of only three members forming the Joint Venture.

11. FINANCING

For the execution of the respective portions of works and to fulfil its obligations in terms of this Joint Venture Agreement, the Parties shall make their own arrangements to bring the required finance, plants and equipment, materials, manpower and other resources.

12. DOCUMENTS & CONFIDENTIALITY

Each Party shall maintain confidentiality and not use any commercial / technical information, received or generated in the course of preparation and submission of the bid or in the course of execution of the contract, if awarded to the JV, for any purpose unrelated to the Contract.

13. ARBITRATION

Any dispute, controversy or claim arising out of or relating to this agreement shall be settled, in the first instance, amicably between the Parties.

If an amicable settlement cannot be reached as above, it will be settled by arbitration in accordance with the broad principles provided for arbitration in the Conditions of Contract.

14. VALIDITY

This Agreement shall remain in force till the occurrence of the earliest to occur of the following, unless by mutual consent, the Parties agree in writing to extend the validity for a further period:

- a. The bid submitted by the Joint Venture is declared unsuccessful, or
- b. Cancellation/ shelving of the Project by the client for any reasons prior to award of work
- c. Execution of detailed JV agreement by the parties, setting out detailed terms after award of work by the Client, substantially covering the requirements as mentioned in Section IV of bidding documents read with Sub-Clause 1.14 [Joint Several Liability] of the Conditions of Contract.

15. This MOU is drawn in _____ number of copies with equal legal strength and status. One copy is held by M/s _____ and one copy by M/s _____ & M/s _____ and M/s _____, each and a copy submitted with the proposal.⁹

16. This MOU shall be construed under the laws of the Bidder's actual or intended country of Registration.

⁹ Modify as appropriate in accordance with the number of members of the JV

17. NOTICES

Notices shall be given in writing by fax confirmed by registered mail or commercial courier to the following fax numbers and addresses.

IN WITNESS WHEREOF THE PARTIES, have executed this MOU the day, month and year first before written:

Authorized Representative

2nd Member

Signature _____

Signature _____

(Name, Address & Contact Details¹⁰)

(Name, Address & Contact Details)

3rd Member¹¹

4th Member¹²

Signature _____

Signature _____

(Name, Address & Contact Details)

(Name, Address & Contact Details)

Witness

1 _____ (Signature, Name & Address)

2 _____ (Signature, Name & Address)

Notes:

1. *In case of existing joint venture, the certified copy of JV Agreement may be furnished.*
2. *The mode of execution should be in accordance with the procedure, if any, laid down by the applicable law in the bidder's country and the charter documents of the executants(s) and when it is so required, the same should be under common seal affixed in accordance with the required procedure.*
3. *Whenever required, the Bidder should submit for verification the extract of the charter documents and the shareholder resolution in favour of the person executing this document on behalf of the bidder.*

¹⁰ Contact Details should contain the telephone & fax numbers and email id.

¹¹ Delete the 3rd and 4th member in case the JV is formed by two members only.

¹² Delete this in case the JV is formed by three members only.

4. *For a required document executed and issued overseas, the document will also have to be legalised by the Indian Embassy in the Bidder's country and notarized in the jurisdiction where it is being issued. However, documents provided by Bidders from countries that have signed the Hague Legislation Convention 1961 are not required to be legalized by the Indian Embassy, if they carry a conforming Apostile certificate.*

(para 2.1(d), Annexure 1, Section III)

Proforma Letter of Participation from Each Member of Joint Venture (JV)

(Firms from India shall execute Form LOP on non-judicial stamp paper of appropriate value. Firms from outside India shall execute Form LOP according to the applicable Law in the Bidder's (Firm's) country and by taking into the account the following text)

No. _____

Date _____

From:

To:

The Managing Director

5th Floor, Pragati Maidan Metro Station Building

New Delhi – 110 001

Subject: Design, Supply, Construction, Installation, Testing and Commissioning of 2x25kV AC Electrification, Signalling & Telecommunication, E&M and Associated Works on Design-Build Lump Sum Basis for Dadri-Khurja Section (approximately 47 Route Km of Double Line) of Eastern Dedicated Freight Corridor

Contract Package No.: 105

Ref: Your notice for Invitation for Bid (IFB) _____

1. We wish to confirm that our company has formed a Joint Venture with (i) and (ii) and (iii)¹³ for the purposes associated with IFB referred to above.

[Member(s) who are not the authorized representative of the JV should add the following paragraph].*

‘The JV is led by whom we hereby authorize to

¹³ (i) In case the JV is formed by two members, delete the words “and (ii) and (iii)”

(ii) In case the JV is formed by three members, delete the words “and (iii)”

act on our behalf for the purposes of the submission of the bid for the above mentioned work and authorize it to incur liabilities and receive instructions for and on behalf of any and all the Members or constituents of the Joint Venture.’*

OR

*(Member being the authorized representative of the group should add the following paragraph)**

‘In this group we act as authorized representative and, for the purposes of applying for qualification, represent the Joint Venture’ *

2. In the event of our JV is awarded the contract, we agree to be jointly with (i) _____ (ii) _____ and (iii) _____ (names of other members of our JV¹⁴) and severally liable to the Dedicated Freight Corridor Corporation of India Limited, its successors and assignees for all obligations, duties and responsibilities arising from or imposed by the contract subsequently entered into between Dedicated Freight Corridor Corporation of India Limited and our JV.
3. We, further agree that entire execution of the contract shall be carried out exclusively through the authorized representative.

Yours faithfully,

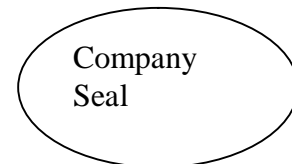

(Signature)

(Name of Signatory) _____

(Capacity of Signatory) _____

* Delete as appropriate

Notes:

1. *The mode of execution should be in accordance with the procedure, if any, laid down by*

¹⁴ (a) In case the JV is formed by two members, delete the words “and (ii) and (iii)”
(b) In case the JV is formed by three members, delete the words “and (iii)”

the applicable law in the bidder's country and the charter documents of the executants(s) and when it is so required, the same should be under common seal affixed in accordance with the required procedure.

2. *Whenever required, the Bidder should submit for verification the extract of the charter documents and the shareholder resolution in favour of the person executing this document on behalf of the bidder.*
3. *For a required document executed and issued overseas, the document will also have to be legalized by the Indian Embassy in the Bidder's country and notarized in the jurisdiction where it is being issued. However, documents provided by Bidders from countries that have signed the Hague Legislation Convention 1961 are not required to be legalized by the Indian Embassy, if they carry a conforming Apostile Certificate.*

(para 2.1(b), Annexure 1, Section III)

Power of Attorney to submit the Bid

(If this POA is executed and issued in India, it should be submitted on a non-judicial Stamp paper of appropriate value. For the POA executed and issued outside India, it shall be executed according to the applicable law in the Bidder's country and by taking into account the Notes shown below.)

Subject: Design, Supply, Construction, Installation, Testing and Commissioning of 2x25kV AC Electrification, Signalling & Telecommunication, E&M and Associated Works on Design-Build Lump Sum Basis for Dadri-Khurja Section (approximately 47 Route Km of Double Line) of Eastern Dedicated Freight Corridor

Contract Package No.: 105

Know all men by these presents, we _____ do hereby constitute, appoint and authorize Mr/Ms _____ who is presently employed with us and holding the position of _____ as our attorney, to do in our name and on our behalf, all such acts, deeds and things necessary in connection with or incidental to our bid for the above mentioned work, including signing and submission of all documents and providing information/responses to Dedicated Freight Corridor Corporation of India Limited, representing us in all matters, dealing with Dedicated Freight Corridor Corporation of India Limited in all matters in connection with our bid for the said project.

We hereby agree to ratify all acts, deeds and things lawfully done by our said attorney pursuant to this Power of Attorney and that all acts, deeds and things done by our aforesaid attorney shall always be deemed to have been done by us.

Dated this the _____ day of _____, _____

(Signature and Name in Block letters of the Signatory delegating the POA)

Seal of Company

The above Power of Attorney is accepted by me

(Signature and Name in Block letters of the person whom POA is being delegated)

Witness

Witness 1:
Signature _____

Name:
Address:
Occupation:

Witness 2:
Signature _____

Name:
Address:
Occupation:

Notes:

- 1. The mode of execution should be in accordance with the procedure, if any, laid down by the applicable law in the bidder's country and the charter documents of the executants(s) and when it is so required, the same should be under common seal affixed in accordance with the required procedure.*
- 2. Whenever required, the Bidder should submit for verification the extract of the charter documents and the shareholder resolution in favour of the person executing this document on behalf of the bidder.*
- 3. For a required document executed and issued overseas, the document will also have to be legalised by the Indian Embassy in the Bidder's country and notarized in the jurisdiction where it is being issued. However, documents provided by Bidders from countries that have signed the Hague Legislation Convention 1961 are not required to be legalized by the Indian Embassy, if they carry a conforming Apostille certificate.*

(para 2.1(c), Annexure 1, Section III)

Power of Attorney to the Authorized Representative of Joint Venture (JV)

(If this POA is executed and issued in India, it should be submitted on a non-judicial Stamp paper of appropriate value. For the POA executed and issued outside India, it shall be executed according to the applicable law in the Bidder's country and by taking into account the Notes shown below.)

POWER OF ATTORNEY¹⁵

Whereas, Dedicated Freight Corridor Corporation of India Limited (DFCCIL) has invited bids for the work of ----- [Insert Contract Package Name and Number], and

Whereas we, the members of the Joint Venture comprising of

- (i) M/s _____; and
- (ii) M/s _____; and
- (iii)* M/s _____; and
- (iv)* M/s _____

are interested in submission of bid for this work in accordance with the terms and conditions contained in the bidding documents and,

Whereas, it is necessary for the members of the Joint Venture to designate one of them as the authorized representative, with all necessary power and authority to do, for and on behalf of the Joint Venture, all acts, deeds and things as may be necessary in connection with the Joint Venture's bid for the project.

NOW THIS POWER OF ATTORNEY WITNESSETH THAT:

We, M/s _____ and *M/s _____ and *M/s _____ hereby nominate M/s _____, being the lead member of the Joint Venture, as the authorized representative of the Joint Venture, to do on behalf of the Joint Venture, all or any of the acts, deeds or things necessary _____

¹⁵ To be executed by all the members of the Joint Venture, except the lead member / authorized representative.

or incidental to the Joint Venture's bid for the contract, including submission of bid, participating in conferences, responding to queries, submission of information/documents and to represent the Joint Venture in all its dealings with the Dedicated Freight Corridor Corporation of India Limited / Railway or any other Government Agency or any person, in connection with the bid / contract for the said work until culmination of the process of bidding and till the contract agreement, if successful, is entered into with DFCCIL and thereafter till the expiry of the contract agreement.

We hereby, jointly and severally ratify, confirm and agree that all acts, deeds and things lawfully done or caused to be done by our said authorized representative or his substitute or substitutes, pursuant to this Power of Attorney, shall always be deemed to have been done by us and / or by the Joint Venture.

Dated this the _____ day of _____, _____

(Signature) _____	(Signature) _____	(Signature) _____
(Name in Block letters of Executant -1)	(Name in Block letters of Executant-2)*	(Name in Block letters of Executant-3)*
Seal of Company	Seal of Company	Seal of Company

Witness 1:	Witness 2:
Signature _____	Signature _____
Name:	Name:
Address:	Address:
Occupation:	Occupation:

The above Power of Attorney is hereby accepted by me for and on behalf of the Lead Member

(Signature of the PA Holder).....

(Name of the Power of Attorney Holder).....

(Designation).....

For and on behalf of *(Name of the Lead Member)*

Notes:

1. *The mode of execution should be in accordance with the procedure, if any, laid down by the applicable law in the bidder's country and the charter documents of the*

executants(s) and when it is so required, the same should be under common seal affixed in accordance with the required procedure.

2. *Whenever required, the Bidder should submit for verification the extract of the charter documents and the shareholder resolution in favour of the person executing this document on behalf of the bidder.*
3. *For a required document executed and issued overseas, the document will also have to be legalised by the Indian Embassy in the Bidder's country and notarized in the jurisdiction where it is being issued. However, documents provided by Bidders from countries that have signed the Hague Legislation Convention 1961 are not required to be legalized by the Indian Embassy, if they carry a conforming Apostle certificate.*

* Delete as appropriate

(para 2.1 (k) of Annexure-1, Section III)

Current Contract Commitments / Works in Progress

Bidders and each partner to a JVA should provide information on their current commitments on all contracts that have been awarded, or for which a letter of intent or acceptance has been received, or for contracts approaching completion, but for which an unqualified, full completion certificate has yet to be issued.

Subject: Design, Supply, Construction, Installation, Testing and Commissioning of 2x25kV AC Electrification, Signalling & Telecommunication, E&M and Associated Works on Design-Build Lump Sum Basis for Dadri-Khurja Section (approximately 47 Route Km of Double Line) of Eastern Dedicated Freight Corridor

Contract Package No.: 105

Name of contract	Employer, contact address/ tel/fax/email	In case of JV, Bidder's Percentage Share	Total Contract Amount	Currency (\$/€/£/NR etc.)	Value of outstanding work as on 28 days before last date of submission of bids	Currency Conversion Rate as on 28 days before last date of submission of bids	Current Value of outstanding work (US\$ equivalent) as on 28 days before last date of submission of bids	Estimated Completion Date	Average monthly invoicing over last six months (US\$/month)	Remarks
(1)	(2)	(3)	(4)	(5)	(6)	(7)	(8)	(9)	(10)	(11)
1.										
2.										
3.										

Name of contract	Employer, contact address/ tel/fax/email	In case of JV, Bidder's Percentage Share	Total Contract Amount	Currency (\$/€/£/NR etc.)	Value of outstanding work as on 28 days before last date of submission of bids	Currency Conversion Rate as on 28 days before last date of submission of bids	Current Value of outstanding work (US\$ equivalent) as on 28 days before last date of submission of bids	Estimated Completion Date	Average monthly invoicing over last six months (US\$/month)	Remarks
(1)	(2)	(3)	(4)	(5)	(6)	(7)	(8)	(9)	(10)	(11)
4.										
5.										
etc.										

Certified that the above information is correct as per our records and nothing has been concealed.

Signature.....NameSigned in the capacity of duly authorized to sign the bid for and on behalf of on dd/mm/yyyy

Notes:

(i) For the purpose of conversion of Indian Rupees (INR) / foreign currency into US\$, Bidders shall use the Foreign Currency Reference Rates published by Reserve Bank of India on 28 days prior to last date of bid submission. In case the currency rates are not published by Reserve Bank of India, the same shall be taken from the internet web site– <http://www.oanda.com/currency/historical-rates>. If the rates are not available on this website also, these can be taken from the internet website <http://www.xe.com/ict/>

(ii) In case the Contract is in JV, the Bidder should provide amounts of complete contract in column (4), (6), (8) and (10).

(para 2.2 of Section III and para 2.1 (j), Annexure 1, Section III)

Financial Resources¹⁶

Specify proposed sources of financing, such as liquid assets, unencumbered real assets, lines of credit, and other financial means, net of current commitments, available to meet the total construction cash flow demands of the subject contract or contracts, as indicated in Section III (Evaluation and Qualification Criteria).

Subject: Design, Supply, Construction, Installation, Testing and Commissioning of 2x25kV AC Electrification, Signalling & Telecommunication, E&M and Associated Works on Design-Build Lump Sum Basis for Dadri-Khurja Section (approximately 47 Route Km of Double Line) of Eastern Dedicated Freight Corridor

Contract Package No.: 105

Source of financing	Amount (US\$ equivalent)
1.	
2.	
3.	
4.	

Note: For the purpose of conversion of Indian Rupees (INR) / foreign currency into US\$, Bidders shall use the Foreign Currency Reference Rates published by Reserve Bank of India on 28 days prior to last date of bid submission. In case rates of currency are not published by Reserve Bank of India, the same shall be taken from the internet web site– <http://www.oanda.com/currency/historical-rates>. If the rates are not available on this website also, these can be taken from the internet website <http://www.xe.com/ict/>

¹⁶In case of Joint Venture, to be submitted by each member

(para 2.1 (I) of Annexure-1, Section III)

Proposed Subcontractors and Suppliers for Major Items of Works

Subject: Design, Supply, Construction, Installation, Testing and Commissioning of 2x25kV AC Electrification, Signalling & Telecommunication, E&M and Associated Works on Design-Build Lump Sum Basis for Dadri-Khurja Section (approximately 47 Route Km of Double Line) of Eastern Dedicated Freight Corridor

Contract Package No.: 105

Major Items of Materials, Equipment or Services to be subcontracted	Proposed Subcontractor, Supplier, or Service Provider	Nationality/ Location of the subcontractor, supplier or service provider	Approximate Value of proposed Subcontracting Items (in percentage of the approximate total value of the Contract)

Note:

The Bidder shall enter in this Schedule the proposed names of subcontractors, suppliers or service providers of major items of materials, equipment or services that the Bidder proposes to incorporate in the Works. Notwithstanding the provision of this information, submission of details of materials, equipment and services for approval, as required by the Contract, will be required from the Contractor.

(para 2.1 (m) of Annexure-1, Section III)

Copyright Undertaking

The Managing Director,
Dedicated Freight Corridor Corporation,
Pragti Maidan Metro Station, New Delhi,
India 110001.

Subject: Design, Supply, Construction, Installation, Testing and Commissioning of 2x25kV AC Electrification, Signalling & Telecommunication, E&M and Associated Works on Design-Build Lump Sum Basis for Dadri-Khurja Section (approximately 47 Route Km of Double Line) of Eastern Dedicated Freight Corridor

Contract Package No.: 105

Dear Sir,

We, (name of Bidder / Joint Venture) hereby undertake that the Design Data, Employer's Requirement, Tender Drawings etc. both in hard copy and Digitized format, and the bidding documents purchased as a necessary part of our preparation of this bid shall be used solely for the preparation of the Bid and that if the bid is successful, shall be used solely for the design of the temporary and permanent works.

We further undertake that the aforesaid tender drawings and documents prepared by Dedicated Freight Corridor Corporation Limited shall not be used in whole, in part or in any altered form on any other project, scheme, design or proposal that the bidder/ Joint Venture /Party to Joint Venture, Sub Contractors of the bidder or Joint Venture /parent company of Party to Joint Venture or the Bidder will be involved with either in India or in any other country.

Signature.....

NameSigned in the capacity of

duly authorized to sign the bid for and on behalf of

Dated on _____ day of _____, _____

Manufacturer's Authorization

(para 2.1 (n) of Annexure-1, Section III)

Subject: Design, Supply, Construction, Installation, Testing and Commissioning of 2x25kV AC Electrification, Signalling & Telecommunication, E&M and Associated Works on Design-Build Lump Sum Basis for Dadri-Khurja Section (approximately 47 Route Km of Double Line) of Eastern Dedicated Freight Corridor

Contract Package No.: 105

Date: _____

ICB No.: _____

To: The Managing Director
Dedicated Freight Corridor Corporation of India Ltd
5th Floor, Pragati Maidan,
Metro Station Building Complex
New Delhi - 110001

WHEREAS

We (Insert name of the Manufacturer) who are official manufacturers of (Insert Name of manufacturing products) having factories at (Insert the location / address of the manufacturing facility) do hereby authorize (Insert name of the Bidder) to submit a bid for Contract No. 105: Technical Proposal for Design, Supply, Construction, Installation, Testing and Commissioning of 2x25kV AC Electrification, Signalling & Telecommunication, E&M and Associated Works on Design-Build Lump Sum Basis for Dadri-Khurja Section (approximately 47 Route Km of Double Line) of Eastern Dedicated Freight Corridor

Descriptions of Goods:

We hereby extend our full guarantee and warranty in accordance with Clause 11 of the General Conditions of Contract, with respect to the goods offered by the above firm.

Signed: _____

Name: _____

Title: _____

Duly authorized to sign this Authorization on behalf of: _____

Dated on _____ day of _____, _____

Contractor's Equipment

The Bidder shall provide adequate information to demonstrate clearly that it has the capability to meet the requirements for the key Contractor's equipment listed in Section III, Evaluation and Qualification Criteria.

All key equipment /plant proposed by the Bidder shall be filled in this form.

Subject: Design, Supply, Construction, Installation, Testing and Commissioning of 2x25kV AC Electrification, Signalling & Telecommunication, E&M and Associated Works on Design-Build Lump Sum Basis for Dadri-Khurja Section (approximately 47 Route Km of Double Line) of Eastern Dedicated Freight Corridor

Contract Package No.: 105

SN	Equipment information					Current status		Source of Equipment	Owner				Agreements*
	Item of equipment	Name of manufacturer	Model and power rating	Capacity	Country of Origin and Year of Manufacture	Current location	Details of current commitments	Owned/Rented /Leased/ Specially manufactured	Name of owner	Address of owner	Contact name and title	Telephone /Email	Details of rental/ lease/ manufacture agreements specific to the project
(1)	(2)	(3)	(4)	(5)	(6)	(7)	(8)	(9)	(10)	(11)	(12)	(13)	(14)

SN	Equipment information					Current status		Source of Equipment	Owner				Agreements*
	Item of equipment	Name of manufacturer	Model and power rating	Capacity	Country of Origin and Year of Manufacture	Current location	Details of current commitments	Owned/Rented/Leased/Specially manufactured	Name of owner	Address of owner	Contact name and title	Telephone /Email	Details of rental/ lease/ manufacture agreements specific to the project
(1)	(2)	(3)	(4)	(5)	(6)	(7)	(8)	(9)	(10)	(11)	(12)	(13)	(14)

*Omit this information for equipment owned by the Bidder.
 Form PER-1

(Para 2.3 of Section III)

Personnel[#]

Subject: Design, Supply, Construction, Installation, Testing and Commissioning of 2x25kV AC Electrification, Signalling & Telecommunication, E&M and Associated Works on Design-Build Lump Sum Basis for Dadri-Khurja Section (approximately 47 Route Km of Double Line) of Eastern Dedicated Freight Corridor

Contract Package No.: 105

S.I.	Key Position	Minimum Qualifying Requirement (years)			Proposed Personnel by the Bidder				Remarks
		Total Experience	In Similar works	Qualification	Name	Total Experience	In Similar works	Qualification	
1.	Project Director**	20	7	B.E. /B. Tech or Equivalent					
2.	Sr. Design Engineer* (Signalling)	15	5	B.E. (Electrical / Electronics) or equivalent					
3.	Sr. Design Engineer* (Telecommunication)	15	5	B.E. (Electronics / Telecommunication) or equivalent					
4.	Sr. Design	15	5	B.E. (Electrical /					

S.I.	Key Position	Minimum Qualifying Requirement (years)			Proposed Personnel by the Bidder				Remarks
		Total Experience	In Similar works	Qualification	Name	Total Experience	In Similar works	Qualification	
	Engineer (OHE)			Mechanical) or equivalent					
5.	Sr. Design Engineer * (2x25 kV Sub Station)	15	5	B.E. (Electrical) or equivalent					
6.	Sr. Design Engineer * (SCADA)	15	5	B.E. (Electrical / Electronics) or equivalent					
7.	System Integrator *	15	5	B.E. /B. Tech or Equivalent					
8.	Interface Manager	15	7	B.E. /B. Tech or Equivalent					
9.	Project Manager	15	5	B.E. /B. Tech or Equivalent					

S.I.	Key Position	Minimum Qualifying Requirement (years)			Proposed Personnel by the Bidder				Remarks
		Total Experience	In Similar works	Qualification	Name	Total Experience	In Similar works	Qualification	
	(Signalling)								
10.	Project Manager (Telecommunication)	15	5	B.E. /B. Tech or Equivalent					
11.	Project Manager (OHE)	15	5	B.E. /B. Tech or Equivalent					
12.	Project Manager * (Traction Sub Station 2x25 kV & SCADA)	15	5	B.E. /B. Tech or Equivalent					
13.	Planner & Scheduler	15	5	B. Tech. or any other Science Graduate (should be					

S.I.	Key Position	Minimum Qualifying Requirement (years)			Proposed Personnel by the Bidder				Remarks
		Total Experience	In Similar works	Qualification	Name	Total Experience	In Similar works	Qualification	
				well conversant with Primavera or similar software)					
14.	Quality Control Expert	15	5	B.E. /B. Tech or Equivalent					
15.	Safety & Health Expert***	15	5	B.E. /B. Tech or Equivalent with Diploma/ Specialization / additional qualification in EHS related field					
16.	RAMS Expert	15	5	B.E. /B. Tech or Equivalent with Diploma/ Specialization in RAMS					

S.I.	Key Position	Minimum Qualifying Requirement (years)			Proposed Personnel by the Bidder				Remarks
		Total Experience	In Similar works	Qualification	Name	Total Experience	In Similar works	Qualification	
17.	Train Management System Expert	15	5	B.E. /B. Tech or Equivalent					
18.	Environmental Expert***	15	5	B.E./B. Tech or Equivalent with Specialization / additional qualification in Environment related field					
19.	Social Expert***	15	5	Master's degree in Social Work or equivalent					

As listed in Section III.

* Minimum 3 (three) years outside India experience in at least one Project

** Minimum 5 (five) years outside India experience in at least two Projects

*** He/she should have worked as a sole expert for large scale Infrastructure projects. Experience in Environment / Safety / Social Risk Assessment, resettlement and rehabilitation and Management plans related to similar project preferably Railways.

Notes:

- (i) The CV's of the Key Personnel should be enclosed as FORM PER - 2
- (ii) The Bidders are advised NOT to submit more than one CV against each of the above mentioned key positions. In case more than one CV is submitted for any key position, such additional CV(s) shall not be considered for evaluation purposes and only the first CV in the bidding document would be considered for evaluation.

Resume of Proposed Personnel

Subject: Design, Supply, Construction, Installation, Testing and Commissioning of 2x25kV AC Electrification, Signalling & Telecommunication, E&M and Associated Works on Design-Build Lump Sum Basis for Dadri-Khurja Section (approximately 47 Route Km of Double Line) of Eastern Dedicated Freight Corridor

Contract Package No.: 105

Name of Bidder		
Position		
Personnel information	Name	Date of birth
	Professional qualifications	
Present employment	Name of employer	
	Address of employer	
	Telephone	Contact (manager / personnel officer)
	Fax	E-mail
	Job title	Years with present employer

Summarize professional experience over the previous number of years as required wide paragraph 2.3 of “**Part 1 Bidding Procedures, Section III**”, in reverse chronological order. Indicate particular technical and managerial experience relevant to the project.

From	To	Company / Project / Position / Relevant technical and management experience

Letter of Bid – Two Stage Bidding, Second Stage Bid

Date: _____

ICB No.: HQ/SYS/EC/D-B/Dadri-Khurja
Invitation for Bid No.: _____

To: _____

Subject: Design, Supply, Construction, Installation, Testing and Commissioning of 2x25kV AC Electrification, Signalling & Telecommunication, E&M and Associated Works on Design-Build Lump Sum Basis for Dadri-Khurja Section (approximately 47 Route Km of Double Line) of Eastern Dedicated Freight Corridor

Contract Package No.: 105

Dear Sir,

We, the undersigned, declare that:

(a) We have examined and have no reservations to the bidding document, (including the Price Schedules 1.0, 2.0, 2.1, to 2.3), including Addenda issued in accordance with Instructions to Bidders (ITB)-8, and we confirm that the First Stage Technical Proposal submitted originally by us shall constitute the 'Updated First Stage Technical Proposal', for the purpose of the Second Stage Bid, together with your requirements incorporated in the Memorandum of Changes (as is required pursuant to 'First Stage Technical Proposal' evaluation). We note from Addendum No....¹⁷ to the Bidding Documents that the Employer's Requirements have been revised.

(b) We offer to submit our bid in conformity with the bidding documents for Contract Number:.....[insert Contract Number]

(c) Excluding the discounts offered below (if any), the price of our Bid for Contract No. 105 in INR is :

INR (Insert Bid Price in figures)

INR

.....(Insert Bid Price in words)

(i) The percentage breakup of Bid Price in INR and not more than 3 foreign currencies is as stated in Appendix to Bid.

¹⁷ Insert the relevant Addenda Number(s)

- (ii) The Currency wise breakup of sub cost centres of the Price Schedule for Payment is given in Annexure-I of Appendix to Bid.

- (d) The discounts offered and the methodology for their application are:

- (e) Our bid shall be valid for a period of 120 (one hundred twenty) days from the date fixed for the submission deadline for the Second Stage bids as stipulated in the Letter of Invitation to submit a Second Stage bid, and it shall remain binding upon us and may be accepted at any time before the expiration of that period;

- (f) If our bid is accepted, we commit to obtain a performance security, in accordance with the bidding document;

- (g) We, including any subcontractors or manufacturers for any part of the contract , have or will have nationalities from eligible countries, in accordance with ITB-4.2;

- (h) We, including any subcontractors or manufacturers for any part of the contract, do not have any conflict of interest in accordance with ITB-4.3;

- (i) We are not submitting more than one bid for each Contract Number in this bidding process as a Bidder, either individually or as a partner in a joint venture, in accordance with ITB-4.3;

- (j) We, along with any of our subcontractors, suppliers, consultants, manufactures, service provider for any part of the contract, are not subject to and not controlled by any entity or individual that is subject to, a temporary suspension or a debarment imposed by a member of the World Bank Group or a debarment imposed by the World Bank Group in accordance with the Agreement for Mutual Enforcement Debarment Decisions between the World Bank and other development banks. Further, we are not ineligible under the Employer’s country laws or other regulations or pursuant to a decision of the United Nations Security Council.

- (k) We are not a government owned entity/ We are a government owned entity but meet the requirements of ITB-4.5¹⁸

- (l) We have paid, or will pay the following commissions, gratuities, or fees with respect to the bidding process or execution of the Contract:

Name of Recipient	Address	Reason	Amount
-------------------	---------	--------	--------

¹⁸ Delete as appropriate

(If none has been paid or is to be paid, indicate “none.”)

- (m) We understand that you are not bound to accept the lowest evaluated bid or any other bid that you may receive.
- (n) We understand that this bid, together with your written acceptance thereof included in your notification of award, shall constitute a binding contract between us, until a formal contract is prepared and executed; and
- (o) We hereby enclose Bid Security of INR 25 Million in terms of ITB 32.1 in Form BS (Section IV- Bidding Forms, Part 1)

Signature.....

NameSigned in the capacity of

duly authorized to sign the bid for and on behalf of

Dated on _____ day of _____, _____

Appendix to Bid

Subject: Design, Supply, Construction, Installation, Testing and Commissioning of 2x25kV AC Electrification, Signalling & Telecommunication, E&M and Associated Works on Design-Build Lump Sum Basis for Dadri-Khurja Section (approximately 47 Route Km of Double Line) of Eastern Dedicated Freight Corridor

Contract Package No.: 105

- (i) The percentage break up of lump sum bid price for local and foreign currencies for Contract Package No. 105 quoted in the Letter of Bid (LOB-SS) is as follows:

Table-1

Currency	A Name of Currency	B Percentage of bid price
Local currency (INR)	INR	
Foreign currency # 1		
Foreign currency # 2		
Foreign currency #3		

- (ii) Apportionment of Contract Price for Payment, According to Cost Centre is as follows:

Table-2

Cost Centre No.	Cost Centre	Percentage of Contract Price
(1)	(2)	(3)
2.1	Electrical Works	
2.2	Signalling Works	
2.3	Telecommunication Works	
	Total	100%

Note:

1. The Bidders may please note that the percentage of the Contract Price to be entered in column (3) of the table should be within the permitted range specified in column (3) “Price Schedule 2.0 - Apportionment of Contract Price for Payments according to Cost Centres”
2. The total of percentages given in column (3) in the above table should be exactly 100%. In case the total is not 100%, the figures in column (3) at S.N. 2.1, to 2.3 shall be adjusted prorate.

Annexure I of Appendix to Bid

CURRENCY WISE BREAK-UP OF SUB COST CENTRES OF THE PRICE SCHEDULE FOR PAYMENT

Sub Cost Centre	Weightage of Cost Centre/Sub Cost Centre A=B+C+D+E	Breakup % of Column 2 for Various Currencies for Payment			
		Foreign Currency #1 (%) B	Foreign Currency #2 (%) C	Foreign Currency #3 (%) D	Local Currency (%) E
(1)	(2)	(3)	(4)	(5)	(6)
<p><i>Note: The total of percentages given in column (3) to (6) in the table should be exactly 100%. In case the total is not 100%, the figures in column (3) to (6) shall be adjusted pro rate. Any arithmetical error in the break-up percentage of the Sub Cost-Centres of the Price Schedule shall be corrected before signing of the Agreement.</i></p>					
Electrical Works – Price Schedule 2.1					
Price Schedule 2.1.1					
2.1.1.1	100%				
2.1.1.2 (a)	100%				
2.1.1.2 (b)	100%				
2.1.1.2 (c)	100%				
2.1.1.2 (d)	100%				
2.1.1.2 (e)	100%				
2.1.1.2 (f)	100%				
2.1.1.2 (g)	100%				
2.1.1.2 (h)	100%				
2.1.1.2 (i)	100%				
2.1.1.3 (a)	100%				

CURRENCY WISE BREAK-UP OF SUB COST CENTRES OF THE PRICE SCHEDULE FOR PAYMENT

Sub Cost Centre	Weightage of Cost Centre/Sub Cost Centre A=B+C+D+E	Breakup % of Column 2 for Various Currencies for Payment			
		Foreign Currency #1 (%)	Foreign Currency #2 (%)	Foreign Currency #3 (%)	Local Currency (%)
		B	C	D	E
(1)	(2)	(3)	(4)	(5)	(6)
<i>Note: The total of percentages given in column (3) to (6) in the table should be exactly 100%. In case the total is not 100%, the figures in column (3) to (6) shall be adjusted pro rate. Any arithmetical error in the break-up percentage of the Sub Cost-Centres of the Price Schedule shall be corrected before signing of the Agreement.</i>					
2.1.1.3 (b)	100%				
2.1.1.3 (c)	100%				
2.1.1.3 (d)	100%				
2.1.1.4	100%				
2.1.1.5	100%				
2.1.1.6	100%				
2.1.1.7	100%				
2.1.1.8	100%				
2.1.1.9	100%				
Price Schedule 2.1.2					
2.1.2.1	100%				
2.1.2.2	100%				
2.1.2.3	100%				
2.1.2.4	100%				
2.1.2.5	100%				

CURRENCY WISE BREAK-UP OF SUB COST CENTRES OF THE PRICE SCHEDULE FOR PAYMENT

Sub Cost Centre	Weightage of Cost Centre/Sub Cost Centre A=B+C+D+E	Breakup % of Column 2 for Various Currencies for Payment			
		Foreign Currency #1 (%)	Foreign Currency #2 (%)	Foreign Currency #3 (%)	Local Currency (%)
		B	C	D	E
(1)	(2)	(3)	(4)	(5)	(6)
<i>Note: The total of percentages given in column (3) to (6) in the table should be exactly 100%. In case the total is not 100%, the figures in column (3) to (6) shall be adjusted pro rate. Any arithmetical error in the break-up percentage of the Sub Cost-Centres of the Price Schedule shall be corrected before signing of the Agreement.</i>					
2.1.2.6	100%				
2.1.2.7	100%				
2.1.2.8	100%				
2.1.2.9	100%				
2.1.2.10	100%				
2.1.2.11	100%				
2.1.2.12	100%				
2.1.2.13	100%				
2.1.2.14	100%				
2.1.2.15	100%				
2.1.2.16	100%				
2.1.2.17	100%				

CURRENCY WISE BREAK-UP OF SUB COST CENTRES OF THE PRICE SCHEDULE FOR PAYMENT

Sub Cost Centre	Weightage of Cost Centre/Sub Cost Centre A=B+C+D+E	Breakup % of Column 2 for Various Currencies for Payment			
		Foreign Currency #1 (%)	Foreign Currency #2 (%)	Foreign Currency #3 (%)	Local Currency (%)
		B	C	D	E
(1)	(2)	(3)	(4)	(5)	(6)
<i>Note: The total of percentages given in column (3) to (6) in the table should be exactly 100%. In case the total is not 100%, the figures in column (3) to (6) shall be adjusted pro rate. Any arithmetical error in the break-up percentage of the Sub Cost-Centres of the Price Schedule shall be corrected before signing of the Agreement.</i>					
Price Schedule 2.1.3					
2.1.3.1	100%				
2.1.3.2	100%				
2.1.3.3	100%				
2.1.3.4	100%				
2.1.3.5	100%				
2.1.3.6	100%				
2.1.3.7	100%				
2.1.3.8	100%				
2.1.3.9	100%				
2.1.3.10	100%				
2.1.3.11	100%				
2.1.3.12	100%				

CURRENCY WISE BREAK-UP OF SUB COST CENTRES OF THE PRICE SCHEDULE FOR PAYMENT

Sub Cost Centre	Weightage of Cost Centre/Sub Cost Centre A=B+C+D+E	Breakup % of Column 2 for Various Currencies for Payment			
		Foreign Currency #1 (%)	Foreign Currency #2 (%)	Foreign Currency #3 (%)	Local Currency (%)
		B	C	D	E
(1)	(2)	(3)	(4)	(5)	(6)
<i>Note: The total of percentages given in column (3) to (6) in the table should be exactly 100%. In case the total is not 100%, the figures in column (3) to (6) shall be adjusted pro rate. Any arithmetical error in the break-up percentage of the Sub Cost-Centres of the Price Schedule shall be corrected before signing of the Agreement.</i>					
2.1.3.13	100%				
2.1.3.14	100%				
2.1.3.15	100%				
Price Schedule 2.1.4					
2.1.4.1	100%				
2.1.4.2	100%				
2.1.4.3	100%				
2.1.4.4	100%				
2.1.4.5	100%				
2.1.4.6	100%				
2.1.4.7	100%				
2.1.4.8	100%				
2.1.4.9	100%				
2.1.4.10	100%				
2.1.4.11	100%				

CURRENCY WISE BREAK-UP OF SUB COST CENTRES OF THE PRICE SCHEDULE FOR PAYMENT

Sub Cost Centre	Weightage of Cost Centre/Sub Cost Centre A=B+C+D+E	Breakup % of Column 2 for Various Currencies for Payment			
		Foreign Currency #1 (%)	Foreign Currency #2 (%)	Foreign Currency #3 (%)	Local Currency (%)
		B	C	D	E
(1)	(2)	(3)	(4)	(5)	(6)
<i>Note: The total of percentages given in column (3) to (6) in the table should be exactly 100%. In case the total is not 100%, the figures in column (3) to (6) shall be adjusted pro rate. Any arithmetical error in the break-up percentage of the Sub Cost-Centres of the Price Schedule shall be corrected before signing of the Agreement.</i>					
2.1.4.12	100%				
2.1.4.13	100%				
Price Schedule 2.1.5					
2.1.5.1	100%				
2.1.5.2	100%				
2.1.5.3	100%				
2.1.5.4	100%				
Price Schedule 2.1.6					
2.1.6.1	100%				
2.1.6.2	100%				
2.1.6.3	100%				
2.1.6.4	100%				
2.1.6.5	100%				
2.1.6.6	100%				
2.1.6.7	100%				

CURRENCY WISE BREAK-UP OF SUB COST CENTRES OF THE PRICE SCHEDULE FOR PAYMENT

Sub Cost Centre	Weightage of Cost Centre/Sub Cost Centre A=B+C+D+E	Breakup % of Column 2 for Various Currencies for Payment			
		Foreign Currency #1 (%)	Foreign Currency #2 (%)	Foreign Currency #3 (%)	Local Currency (%)
		B	C	D	E
(1)	(2)	(3)	(4)	(5)	(6)
<i>Note: The total of percentages given in column (3) to (6) in the table should be exactly 100%. In case the total is not 100%, the figures in column (3) to (6) shall be adjusted pro rate. Any arithmetical error in the break-up percentage of the Sub Cost-Centres of the Price Schedule shall be corrected before signing of the Agreement.</i>					
2.1.6.8	100%				
2.1.6.9	100%				
2.1.6.10	100%				
2.1.6.11	100%				
Price Schedule 2.1.7					
2.1.7.1 (a)	100%				
2.1.7.1 (b)	100%				
2.1.7.1 (c)	100%				
2.1.7.1 (d)	100%				
2.1.7.2 (a)	100%				
2.1.7.2 (b)	100%				
2.1.7.2 (c)	100%				
2.1.7.2 (d)	100%				
2.1.7.2 (e)	100%				
2.1.7.3 (a)	100%				

CURRENCY WISE BREAK-UP OF SUB COST CENTRES OF THE PRICE SCHEDULE FOR PAYMENT

Sub Cost Centre	Weightage of Cost Centre/Sub Cost Centre A=B+C+D+E	Breakup % of Column 2 for Various Currencies for Payment			
		Foreign Currency #1 (%)	Foreign Currency #2 (%)	Foreign Currency #3 (%)	Local Currency (%)
		B	C	D	E
(1)	(2)	(3)	(4)	(5)	(6)
<i>Note: The total of percentages given in column (3) to (6) in the table should be exactly 100%. In case the total is not 100%, the figures in column (3) to (6) shall be adjusted pro rate. Any arithmetical error in the break-up percentage of the Sub Cost-Centres of the Price Schedule shall be corrected before signing of the Agreement.</i>					
2.1.7.3 (b)	100%				
Price Schedule 2.1.8					
2.1.8.1	100%				
2.1.8.2	100%				

CURRENCY WISE BREAK-UP OF SUB COST CENTRES OF THE PRICE SCHEDULE FOR PAYMENT

Sub Cost Centre	Weightage of Cost Centre/Sub Cost Centre A=B+C+D+E	Breakup % of Column 2 for Various Currencies for Payment			
		Foreign Currency #1 (%)	Foreign Currency #2 (%)	Foreign Currency #3 (%)	Local Currency (%)
		B	C	D	E
(1)	(2)	(3)	(4)	(5)	(6)
<i>Note: The total of percentages given in column (3) to (6) in the above table should be exactly 100%. In case the total is not 100%, the figures in column (3) to (6) shall be adjusted pro rate. Any arithmetical error in the break-up percentage of the Sub Cost-Centres of the Price Schedule shall be corrected before signing of the Agreement.</i>					
Signalling Works – Price Schedule 2.2					
Price Schedule 2.2.1					
2.2.1.1	100%				
2.2.1.2	100%				

CURRENCY WISE BREAK-UP OF SUB COST CENTRES OF THE PRICE SCHEDULE FOR PAYMENT

Sub Cost Centre	Weightage of Cost Centre/Sub Cost Centre A=B+C+D+E	Breakup % of Column 2 for Various Currencies for Payment			
		Foreign Currency #1 (%)	Foreign Currency #2 (%)	Foreign Currency #3 (%)	Local Currency (%)
		B	C	D	E
(1)	(2)	(3)	(4)	(5)	(6)
<i>Note: The total of percentages given in column (3) to (6) in the table should be exactly 100%. In case the total is not 100%, the figures in column (3) to (6) shall be adjusted pro rate. Any arithmetical error in the break-up percentage of the Sub Cost-Centres of the Price Schedule shall be corrected before signing of the Agreement.</i>					
2.2.1.3	100%				
2.2.1.4	100%				
2.2.1.5	100%				
2.2.1.6	100%				
2.2.1.7	100%				
Price Schedule 2.2.2					
2.2.2.1	100%				
2.2.2.2	100%				
2.2.2.3	100%				
2.2.2.4	100%				
2.2.2.5	100%				
2.2.2.6	100%				
2.2.2.7	100%				
2.2.2.8	100%				
2.2.2.9	100%				

CURRENCY WISE BREAK-UP OF SUB COST CENTRES OF THE PRICE SCHEDULE FOR PAYMENT

Sub Cost Centre	Weightage of Cost Centre/Sub Cost Centre A=B+C+D+E	Breakup % of Column 2 for Various Currencies for Payment			
		Foreign Currency #1 (%)	Foreign Currency #2 (%)	Foreign Currency #3 (%)	Local Currency (%)
		B	C	D	E
(1)	(2)	(3)	(4)	(5)	(6)
<i>Note: The total of percentages given in column (3) to (6) in the table should be exactly 100%. In case the total is not 100%, the figures in column (3) to (6) shall be adjusted pro rate. Any arithmetical error in the break-up percentage of the Sub Cost-Centres of the Price Schedule shall be corrected before signing of the Agreement.</i>					
2.2.2.10	100%				
2.2.2.11	100%				
2.2.2.12	100%				
2.2.2.13	100%				
2.2.2.14	100%				
Price Schedule 2.2.3					
2.2.3.1	100%				
2.2.3.2	100%				
2.2.3.3	100%				
2.2.3.4	100%				
2.2.3.5	100%				
2.2.3.6	100%				
2.2.3.7	100%				
2.2.3.8	100%				
2.2.3.9	100%				

CURRENCY WISE BREAK-UP OF SUB COST CENTRES OF THE PRICE SCHEDULE FOR PAYMENT

Sub Cost Centre	Weightage of Cost Centre/Sub Cost Centre A=B+C+D+E	Breakup % of Column 2 for Various Currencies for Payment			
		Foreign Currency #1 (%)	Foreign Currency #2 (%)	Foreign Currency #3 (%)	Local Currency (%)
		B	C	D	E
(1)	(2)	(3)	(4)	(5)	(6)
<i>Note: The total of percentages given in column (3) to (6) in the table should be exactly 100%. In case the total is not 100%, the figures in column (3) to (6) shall be adjusted pro rate. Any arithmetical error in the break-up percentage of the Sub Cost-Centres of the Price Schedule shall be corrected before signing of the Agreement.</i>					
2.2.3.10	100%				
2.2.3.11	100%				
2.2.3.12	100%				
2.2.3.13	100%				
2.2.3.14	100%				
2.2.3.15	100%				
Price Schedule 2.2.4					
2.2.4.1	100%				
2.2.4.2	100%				
2.2.4.3	100%				
2.2.4.4	100%				
2.2.4.5	100%				
2.2.4.6	100%				
2.2.4.7	100%				
2.2.4.8	100%				

CURRENCY WISE BREAK-UP OF SUB COST CENTRES OF THE PRICE SCHEDULE FOR PAYMENT

Sub Cost Centre	Weightage of Cost Centre/Sub Cost Centre A=B+C+D+E	Breakup % of Column 2 for Various Currencies for Payment			
		Foreign Currency #1 (%)	Foreign Currency #2 (%)	Foreign Currency #3 (%)	Local Currency (%)
		B	C	D	E
(1)	(2)	(3)	(4)	(5)	(6)
<i>Note: The total of percentages given in column (3) to (6) in the table should be exactly 100%. In case the total is not 100%, the figures in column (3) to (6) shall be adjusted pro rate. Any arithmetical error in the break-up percentage of the Sub Cost-Centres of the Price Schedule shall be corrected before signing of the Agreement.</i>					
2.2.4.9	100%				
2.2.4.10	100%				
2.2.4.11	100%				
2.2.4.12	100%				
2.2.4.13	100%				
2.2.4.14	100%				
2.2.4.15	100%				
2.2.4.16	100%				
Price Schedule 2.2.5					
2.2.5.1 (a)	100%				
2.2.5.1 (b)	100%				
2.2.5.1 (c)	100%				
2.2.5.1 (d)	100%				
2.2.5.1 (e)	100%				
2.2.5.1 (f)	100%				

CURRENCY WISE BREAK-UP OF SUB COST CENTRES OF THE PRICE SCHEDULE FOR PAYMENT

Sub Cost Centre	Weightage of Cost Centre/Sub Cost Centre A=B+C+D+E	Breakup % of Column 2 for Various Currencies for Payment			
		Foreign Currency #1 (%)	Foreign Currency #2 (%)	Foreign Currency #3 (%)	Local Currency (%)
		B	C	D	E
(1)	(2)	(3)	(4)	(5)	(6)
<i>Note: The total of percentages given in column (3) to (6) in the table should be exactly 100%. In case the total is not 100%, the figures in column (3) to (6) shall be adjusted pro rate. Any arithmetical error in the break-up percentage of the Sub Cost-Centres of the Price Schedule shall be corrected before signing of the Agreement.</i>					
2.2.5.1 (g)	100%				
2.2.5.2	100%				
Price Schedule 2.2.6					
2.2.6.1	100%				
2.2.6.2	100%				
Price Schedule 2.2.7					
2.2.7.1	100%				
Telecommunication Works – Price Schedule 2.3					
Price Schedule 2.3.1					
2.3.1.1	100%				
2.3.1.2	100%				
2.3.1.3	100%				
2.3.1.4	100%				
2.3.1.5	100%				
2.3.1.6	100%				

CURRENCY WISE BREAK-UP OF SUB COST CENTRES OF THE PRICE SCHEDULE FOR PAYMENT

Sub Cost Centre	Weightage of Cost Centre/Sub Cost Centre A=B+C+D+E	Breakup % of Column 2 for Various Currencies for Payment			
		Foreign Currency #1 (%)	Foreign Currency #2 (%)	Foreign Currency #3 (%)	Local Currency (%)
		B	C	D	E
(1)	(2)	(3)	(4)	(5)	(6)
<i>Note: The total of percentages given in column (3) to (6) in the table should be exactly 100%. In case the total is not 100%, the figures in column (3) to (6) shall be adjusted pro rate. Any arithmetical error in the break-up percentage of the Sub Cost-Centres of the Price Schedule shall be corrected before signing of the Agreement.</i>					
2.3.1.7	100%				
2.3.1.8	100%				
2.3.1.9	100%				
Price Schedule 2.3.2					
2.3.2.1	100%				
2.3.2.2	100%				
2.3.2.3	100%				
2.3.2.4	100%				
2.3.2.5	100%				
2.3.2.6	100%				
2.3.2.7	100%				
2.3.2.8	100%				
2.3.2.9	100%				

CURRENCY WISE BREAK-UP OF SUB COST CENTRES OF THE PRICE SCHEDULE FOR PAYMENT

Sub Cost Centre	Weightage of Cost Centre/Sub Cost Centre A=B+C+D+E	Breakup % of Column 2 for Various Currencies for Payment			
		Foreign Currency #1 (%)	Foreign Currency #2 (%)	Foreign Currency #3 (%)	Local Currency (%)
		B	C	D	E
(1)	(2)	(3)	(4)	(5)	(6)
<i>Note: The total of percentages given in column (3) to (6) in the table should be exactly 100%. In case the total is not 100%, the figures in column (3) to (6) shall be adjusted pro rate. Any arithmetical error in the break-up percentage of the Sub Cost-Centres of the Price Schedule shall be corrected before signing of the Agreement.</i>					
2.3.2.10	100%				
2.3.2.11	100%				
2.3.2.12	100%				
2.3.2.13	100%				
Price Schedule 2.3.3					
2.3.3.1	100%				
2.3.3.2	100%				
2.3.3.3	100%				
2.3.3.4	100%				
2.3.3.5	100%				
2.3.3.6	100%				
2.3.3.7	100%				
2.3.3.8	100%				
2.3.3.9	100%				
2.3.3.10	100%				

CURRENCY WISE BREAK-UP OF SUB COST CENTRES OF THE PRICE SCHEDULE FOR PAYMENT

Sub Cost Centre	Weightage of Cost Centre/Sub Cost Centre A=B+C+D+E	Breakup % of Column 2 for Various Currencies for Payment			
		Foreign Currency #1 (%)	Foreign Currency #2 (%)	Foreign Currency #3 (%)	Local Currency (%)
		B	C	D	E
(1)	(2)	(3)	(4)	(5)	(6)
<i>Note: The total of percentages given in column (3) to (6) in the table should be exactly 100%. In case the total is not 100%, the figures in column (3) to (6) shall be adjusted pro rate. Any arithmetical error in the break-up percentage of the Sub Cost-Centres of the Price Schedule shall be corrected before signing of the Agreement.</i>					
Price Schedule 2.3.4					
2.3.4.1	100%				
2.3.4.2	100%				
2.3.4.3	100%				
2.3.4.4	100%				
2.3.4.5	100%				
2.3.4.6	100%				
2.3.4.7	100%				
2.3.4.8	100%				
2.3.4.9	100%				
2.3.4.10	100%				
2.3.4.11	100%				
2.3.4.12	100%				
2.3.4.13	100%				

CURRENCY WISE BREAK-UP OF SUB COST CENTRES OF THE PRICE SCHEDULE FOR PAYMENT

Sub Cost Centre	Weightage of Cost Centre/Sub Cost Centre A=B+C+D+E	Breakup % of Column 2 for Various Currencies for Payment			
		Foreign Currency #1 (%)	Foreign Currency #2 (%)	Foreign Currency #3 (%)	Local Currency (%)
		B	C	D	E
(1)	(2)	(3)	(4)	(5)	(6)
<i>Note: The total of percentages given in column (3) to (6) in the table should be exactly 100%. In case the total is not 100%, the figures in column (3) to (6) shall be adjusted pro rate. Any arithmetical error in the break-up percentage of the Sub Cost-Centres of the Price Schedule shall be corrected before signing of the Agreement.</i>					
Price Schedule 2.3.5					
2.3.5.1	100%				
2.3.5.2	100%				
Price Schedule 2.3.6					
2.3.6.1	100%				
Price Schedule 2.3.7					
2.3.7.1	100%				
Price Schedule 2.3.8					
2.3.8.1	100%				

(Clause 32.2; ITB; Section-I)

Form of Bid Security

Required for Second Stage Bid Only

(Bank Guarantee)

On the letterhead of the Bank

Beneficiary: Dedicated Freight Corridor Corporation of India Ltd

Invitation for Bids No: _____

Date: _____

BID GUARANTEE No.: _____

Guarantor: _____

We have been informed that _____ (hereinafter called "the Bidder") has submitted or will submit to the Beneficiary its bid (hereinafter called "the Bid") for the execution of Contract Package Name and Number _____ under Invitation for Bids No. _____ ("the IFB").

Furthermore, we understand that, according to the Beneficiary's conditions, bids must be supported by a bid guarantee.

At the request of the Bidder, we(*Name of the Bank*), as Guarantor, hereby irrevocably undertake to pay the Beneficiary any sum or sums not exceeding in total an amount of _____ (*amount in words*) upon receipt by us of the Beneficiary's complying demand, supported by the Beneficiary's statement, whether in the demand itself or a separate signed document accompanying or identifying the demand, stating that either the Bidder:

(a) has withdrawn its Bid during the period of bid validity set forth in the Bidder's Letter of Bid ("the Bid Validity Period"), or any extension thereto provided by the Bidder;

or

(b) having been notified of the acceptance of its Bid by the Beneficiary during the Bid Validity Period or any extension thereto provided by the Bidder, (i) has failed to execute the contract agreement, or (ii) has failed to furnish the performance security and the Environmental, Social, Health and Safety (ESHS) Performance Security, in

accordance with the Instructions to Bidders (“ITB”) of the Beneficiary’s bidding document.

This guarantee will expire: (a) if the Bidder is the successful bidder, upon our receipt of copies of the contract agreement signed by the Bidder, the performance security and the Environmental, Social, Health and Safety (ESHS) Performance Security issued to the Beneficiary in relation to such contract agreement; or (b) if the Bidder is not the successful bidder, upon the earlier of (i) our receipt of a copy of the Beneficiary’s notification to the Bidder of the results of the bidding process; or (ii) twenty-eight days after the end of the Bid Validity Period.

Consequently, any demand for payment under this guarantee must be received by us at the office indicated above on or before that date.

This guarantee is subject to the Uniform Rules for Demand Guarantees (URDG) 2010 Revision, ICC Publication No. 758.

[signature(s)]with seal of the Bank

Note: All italicized text is for use in preparing this form and shall be deleted from the final document

PRICE SCHEDULES

(Sub-clause 14.4, Conditions of Contract)

PRICE SCHEDULE 1.0

For Payments in Local & Foreign Currencies

Subject: Design, Supply, Construction, Installation, Testing and Commissioning of 2x25kV AC Electrification, Signalling & Telecommunication, E&M and Associated Works on Design-Build Lump Sum Basis for Dadri-Khurja Section (approximately 47 Route Km of Double Line) of Eastern Dedicated Freight Corridor

Contract Package No.: 105

Bid Price for Contract Package No. 105: Design, Supply, Construction, Installation, Testing and Commissioning of 2x25kV AC Electrification, Signalling & Telecommunication, E&M and Associated Works on Design-Build Lump Sum Basis for Dadri-Khurja Section (approximately 47 Route Km of Double Line) of Eastern Dedicated Freight Corridor, shall be the same as the sum quoted in the Letter of Bid-Two Stage Bidding, Second Stage, in INR.

All payments in applicable currencies shall be made as per clause 14.15 of Conditions of Contract. Foreign currency requirements shall be expressed in accordance with ITB 30.1.

For the following materials to be procured from outside India the relevant indices for price adjustment shall be as stated in table below: The applicable whole sale cost index for the relevant input of the respective country shall apply. In case a published index for such goods or services is not available the whole sale price index of relevant category of the country shall be used. (Refer sub clause 13.8 of GC for further details on price adjustment)

S No.	Item	Name of published index nearest to the Base date	Source of Publication
1	Labour		
2	Cement & Lime		
3	Steel (Long)		
4	Copper		
5	Electrical Accessories, Wires and Cables		
6	Electrical Machinery, Equipment & Batteries		
7	Communication Equipment		
8	Fuel & Power		

Source of Index shall be as published by Government or public organization. The bidder should also attach specimens of the publications for the last 12 months. In case Euro is one of the foreign

currencies in which the payment of contract price is to be made, the price index should be the index published by the European Union.

Note: In case the Bidder does not provide the Indexes and Source of Index, the Bidder shall not be entitled for the Price Adjustment for the items procured from outside India.

Payments for supply of Material which is intended for installation in the Permanent Works:

1. The Contractor shall ensure that the Materials delivered at site,
 - a) are as per the required specification,
 - b) have met all the requirements of checks & tests, and
 - c) are properly stored and protected against loss/pilferage, damage and deterioration.
2. The payment for supply of materials shall be made against an Indemnity Bond, for the amount of payment claimed, in favour of the Employer and valid till these materials are installed in the Permanent Works.
3. Supplied materials shall be deemed to be the property of the Employer, and the Contractor shall not remove these from Site of Work / Store without prior approval of the Engineer.
4. Record of receipt and use of materials shall be maintained by the Contractor and made available for inspection by the Engineer/Employer as and when these may be required.

Price Schedule 2.0 Apportionment of Contract Price for Payments According to Cost Centres

(Sub-clause 14.4, GC)

Cost Centre No.	Cost Centre	Permitted Percentage Range of Contract Price ¹⁹
(1)	(2)	(3)
2.1	Electrical Works	58.00 to 68.00
2.2	Signalling Works	25.00 to 35.00
2.3	Telecommunication Works	06.00 to 14.00

Notes:

1. In Table-2 of the Appendix to Bid, the Bidder is permitted to propose change as per his requirement for the component of work within the range indicated in column 3 of the above Price Schedule 2.0, the total of which should be exactly equal to 100%. In case the total is not 100%, the figures at Cost Centres 2.1 to 2.3 in column (3) of Table-2 of the Appendix to Bid shall be adjusted prorata.
2. The Bidder is not required to fill/change any figure(s) in col. (3) of the above stated Price Schedule 2.0.
3. The figure(s) in col. (3) of the above stated Price Schedule 2.0. shall be updated, based on the adjusted figures quoted by the Bidder in Table-2 of the Appendix to Bid, by the Employer at the time of signing the Contract.
4. The subsequent Price Schedules for Cost Centres/Sub-Cost Centres are fixed and the payment will be released for different cost centres/sub-cost centres as per respective weightings of the Contract price.
5. Please refer Sub-Clause 14.4 – Particular Conditions of Contract for further details.

¹⁹ To be updated at the time of signing the Contract.

PRICE SCHEDULE 2.1

Apportionment of Contract Price for Payment according to cost centres ELECTRICAL WORKS - COST CENTRE 2.1

(Sub-clause 14.4, GC)

Price Schedule	Price Schedule No.	Cost Centre	Weightage of Cost Centre 2.1 (%)	Cost
(1)	(2)	(3)	(4)	(5)
2.1 [ELECTRICAL WORKS]	2.1.1	Surveys, Investigations, Studies, Design & Documents, O & M Manuals and As Built Drawings, Training of Staff	5	% as applicable in for Cost Centre 2.0 of Apportionment of Contract Price
	2.1.2	OHE Works	47	
	2.1.3	Traction Sub Station (TSS) Works	28	
	2.1.4	Sub-Sectioning Post (SSP) Works	10	
	2.1.5	SCADA Works	1	
	2.1.6	E&M Works	2	
	2.1.7	Supply of Contract Spares and Special Tools & Instruments	3	
	2.1.8	Integrated Testing, Commissioning and Final Taking over of Works	4	
			Total	

Note: All the Cost Centres and Details of the Scope as indicated above shall be read in conjunction with the Employer's Requirement General Specifications (GS) and Particular Specifications (PS) as applicable.

PRICE SCHEDULE 2.1.1

Apportionment of Contract Price for Payment of Cost Centre

SURVEYS, INVESTIGATIONS, MANAGEMENT PLANS, STUDIES, DESIGN & DOCUMENTS, O & M MANUALS AND AS BUILT DRAWINGS, TRAINING OF STAFF

(Sub-clause 14.4, GC)

Cost Centre	Item of work	Sub-Cost Centre	Stage Payment (Stage to be completed to qualify for Payment of Sub-Cost Centre)	Weightage (%)	Cost	Payment Procedure
(1)	(2)	(3)	(4)	(5)	(6)	(7)
2.1.1 [Surveys, Investigations, Management Plans, Studies, Design & Documents, O & M Manuals and As Built Drawings, Training of Staff]	Survey & Geo-Technical investigations	2.1.1.1	Surveys & Geo-Technical investigations for , AC Traction Electrification, E&M and associated works	2	5% of the Cost Centre 2.1(Apportionment of Contract Price) for Electrical Works	After review/ approval with or without comments by the Engineer
		Studies & Designs	2.1.1.2.	Preliminary design & Documents		
	a) Inception Report including Design Manual		2			
	b) Submission of System Requirement Specification (SRS)		3			
	c) Submission of Management Plans		5			
	d) Traction Simulation study report		6			
	e) Traction Power Supply system design with supportive calculations		3			
	f) OHE Works with supportive calculations		2			
	g) Earthing & Bonding scheme		1			
	h) SCADA system		4			
	i) E&M works	4				
		2.1.1.3	Detailed Design & Documents for Electrical works including layout Plans, Design Manuals and GFC(Good for Construction Drawings) and other Construction Reference Drawings like Combined Service Drawings etc.			
		(a) OHE Works		15		

Cost Centre	Item of work	Sub-Cost Centre	Stage Payment (Stage to be completed to qualify for Payment of Sub-Cost Centre)	Weightage (%)	Cost	Payment Procedure	
(1)	(2)	(3)	(4)	(5)	(6)	(7)	
			(b) Traction Power Supply works	25			
			(c) SCADA works	5			
			(d) E&M works	6			
	As-Built Drawings & Documents	2.1.1.4	As-Built Drawings for Completed Works	4			
	O & M Manuals	2.1.1.5	O & M Manuals	2			
	RAMS	2.1.1.6	RAMS Demonstration tests, report, Establishing FRACAS and Defect Notification stage RAMS Plan	3			
	Any other document	2.1.1.7	Any other Design compliance and document required to be prepared as part of the Contract	2			
	Training	2.1.1.8	Training	5			On completion of Training as per the approved Training Plan and submission of Training Manual duly reviewed/ approved by the Engineer
	Permits and Approvals	2.1.1.9	Obtaining Permits and Approvals as required from various Statutory & Government Bodies	1			On commencement of Commercial Operation of Train Services
			TOTAL	100%			

Note:

- Adjustment to Contract Price pursuant to GCC 13.8 shall NOT be applicable to the payments of Works executed under this Cost Centre / Price Schedule.
- Payment will be made on pro-rata completion of each Payment Stage as per Weightage(s) given in this Schedule.

PRICE SCHEDULE 2.1.2

Apportionment of Contract Price for Payment of Cost Centre OHE WORKS

(Sub-clause 14.4, GC)

Cost Centre	Item of work	Sub-Cost Centre	Stage Payment (Stage to be completed to qualify for Payment of Sub-Cost Centre)	Weightage (%)	Cost	Payment Procedure
(1)	(2)	(3)	(4)	(5)	(6)	(7)
2.1.2 [OHE Works]	Supply of materials	2.1.2.1	Supply of Contact wire	23	For one TKM the apportioned price is 47% of cost centre 2.1 (Apportionment of Contract Price for Electrical Works)/n, where n is number of TKMs	On supply of material at site as per approved quantity duly inspected by the appropriate authority and verified by the Engineer
		2.1.2.2	Supply of Catenary wire	16		
		2.1.2.3	Supply of Feeder wire	3		
		2.1.2.4	Supply of Steel structures Masts/Portals and Small Parts Steel (SPS)	17.5		
		2.1.2.5	Supply of Cantilever assembly without Cantilever insulators	9.5		
		2.1.2.6	Supply of Auto Tensioning Devices (ATD)	3.3		
		2.1.2.7	Supply of Insulators for Cantilevers and other types of Insulators (except those for PTFE and Section Insulators)	5.5		
		2.1.2.8	Supply of PTFE and Section insulators	0.4		
		2.1.2.9	Supply of 25kV/240V LT Supply Aux. Transformers at stations, LC Gates, Auto cable huts and for 240 V power requirement all along the Track alignment (Excluding TSS and SSP as covered elsewhere)	0.4		
		2.1.2.10	Supply of balance materials including Jumpers, droppers, Isolators, HT & control cables, Terminations, Termination Assemblies, Insulations as required for successful commissioning of the OHE works	4		

Cost Centre	Item of work	Sub-Cost Centre	Stage Payment (Stage to be completed to qualify for Payment of Sub-Cost Centre)	Weightage (%)	Cost	Payment Procedure
(1)	(2)	(3)	(4)	(5)	(6)	(7)
	Erection	2.1.2.11	Completion of Foundation work	4.2		Review and Acceptance of Installation Test Report by the Engineer
		2.1.2.12	Erection of Steel structures Mast/ Portals and SPS	1		
		2.1.2.13	Erection of Cantilever assembly along with cantilever Insulators	0.7		
		2.1.2.14	Completion of Wiring work inclusive of feeder wire, cross feeder/ Cabling, Terminations etc. along with droppers, jumpers, Insulations/ Cut-in Insulators, Termination arrangements (ATDs),	2.5		
		2.1.2.15	Supply, Erection/laying of Aerial earth wire (AEW), Buried Earth Conductors (BEC) and all Earthing, Bonding, Lightning Protection, interconnection including Safety items Earth screens, caution/ Warning boards etc. as required all along the Track alignment	4.8		
		2.1.2.16	Erection of Section Insulators, PTFEs, LT Aux. Transformers and other associated fittings, Circuit Breakers, Interrupters and Isolators including laying of Power & Control cables etc. as required	0.2		

Cost Centre	Item of work	Sub-Cost Centre	Stage Payment (Stage to be completed to qualify for Payment of Sub-Cost Centre)	Weightage (%)	Cost	Payment Procedure
(1)	(2)	(3)	(4)	(5)	(6)	(7)
	System acceptance test	2.1.2.17	Final Adjustment, SED checking including Tower wagon checking/ pantograph run , System acceptance Testing and commissioning / Energisation of OHE System and completion of any other residual works of OHE system and Electrical Signage as required	4		Review and Acceptance of System Acceptance Test Report by the Engineer
			TOTAL	100%		

Note:

1. Adjustment to Contract Price pursuant to GCC 13.8 shall be applicable to the payments of Works executed under this Cost Centre / Price Schedule.
2. Payment will be made on Pro-rata completion of Track Km Length (TKM) as per weightage(s) given in this Schedule.

PRICE SCHEDULE 2.1.3

Apportionment of Contract Price for Payment of Cost Centre

TRACTION SUB STATION (TSS) WORKS

(Sub-clause 14.4, GC)

Cost Centre	Item of work	Sub-Cost Centre	Stage Payment (Stage to be completed to qualify for Payment of Sub- Cost Centre)	Weightage (%)	Cost	Payment Procedure	
(1)	(2)	(3)	(4)	(5)	(6)	(7)	
2.1.3 [Traction Sub Station (TSS) Works]	Supply of Materials	2.1.3.1	Supply of Steel structures and Small Parts Steel (SPS) as required	3	For One TSS the Apportioned price is 28% of cost centre 2.1 (Apportionment of Contract Price for Electrical Works)	On supply of material at site as per approved quantity duly inspected by the appropriate authority and verified by the Engineer	
		2.1.3.2	Supply of Traction Power Transformers.	43			
		2.1.3.3	Supply of Auto Transformers and 25kV/240V LT Supply Transformers as required	19.0			
		2.1.3.4	Supply of Switchgears and Control gears, Circuit Breaker, interrupters CT, PT isolators etc. as required	6			
		2.1.3.5	Supply Control and Relay Panels fully assembled	2			
		2.1.3.6	Supply of all other balance material including cables, Bus bar, Earthing Material, Lightning Arresters, Battery set, Battery Chargers etc. including Dynamic VAR compensation, power quality control devices as required for commissioning of Power Supply Installations and associated facilities under the scope of Work	11			
	Erection	2.1.3.7	Completion of Earthwork, Fencing, foundation & Trenching, Dewatering & drainage works	5			Review and Acceptance of Installation Test Report by the Engineer
		2.1.3.8	Erection of Steel structures and SPS	0.6			
		2.1.3.9	Erection of Traction Transformers	2.2			
		2.1.3.10	Erection of Auto Transformers and 25kV/240V LT Transformers	1			

Cost Centre	Item of work	Sub-Cost Centre	Stage Payment (Stage to be completed to qualify for Payment of Sub- Cost Centre)	Weightage (%)	Cost	Payment Procedure
(1)	(2)	(3)	(4)	(5)	(6)	(7)
		2.1.3.11	Erection of Switchgears and Control gears, Circuit Breaker, interrupters and isolators etc. as required	0.3		
		2.1.3.12	Erection & commissioning of Control and Relay Panel and other Protection, Control & Monitoring Equipment and Control Cabling.	0.2		
		2.1.3.13	Construction of Control room Building and its E&M works i.e. Building electrification, ventilation and switch yard lighting etc.	1.5		
		2.1.3.14	Erection/ Completion of all other indoor/outdoor equipment and balance works including Bus-bars, Earth mat/ Earthing & bonding system, Lightning Protection System, Fire Detection & Suppression, Power Distribution Boards, Cabling, Battery, Battery Chargers, Signage & Safety Equipment etc. as required for commissioning of Power supply installations.	1.2		
	System Acceptance Test	2.1.3.15	Transformer Oil centrifuging, System Acceptance Testing & commissioning of power supply Installations, Other Facilities and Energisation	4		Review and Acceptance of System Acceptance Test Report by the Engineer
			TOTAL	100%		

Note:

- 1- Adjustment to Contract Price pursuant to GCC 13.8 shall be applicable to the payments of Works executed under this Cost Centre / Price Schedule.
- 2- Payment will be made on Pro-rata completion of each Payment Stage as per Weightage(s) given in this Schedule.

PRICE SCHEDULE 2.1.4

Apportionment of Contract Price for Payment of Cost Centre

SUB-SECTIONING POST (SSP) WORKS

(Sub-clause 14.4, GC)

Cost Centre	Item of work	Sub-Cost Centre	Stage Payment (Stage to be completed to qualify for Payment of Sub-Cost Centre)	Weightage (%)	Cost	Payment Procedure	
(1)	(2)	(3)	(4)	(5)	(6)	(7)	
2.1.4 [Sub-Sectioning Post (SSP) Works]	Supply	2.1.4.1	Supply of Steel structures and Small Parts Steel (SPS) as required	6.2	For One SSP the Apportioned price is 10 % of cost centre 2.1 (Apportionment of Contract Price for Electrical Works)/ n , where n is number of SSPs	On supply of material at site as per approved quantity duly inspected by the appropriate authority and verified by the Engineer	
		2.1.4.2	Supply of Auto Transformers and 25kV/240V LT Supply Transformers as required	51.4			
		2.1.4.3	Supply of Switchgears & Control gears, Circuit Breaker, interrupters and isolators etc. as required	5.1			
		2.1.4.4	Supply of Control & Relay panel as required	6.3			
		2.1.4.5	Supply of all other balance material including cables, Bus bar, Earthing Material, Battery set, Battery Chargers etc. as required for commissioning of Power Supply Installations and associated facilities under the scope of Work	12			
	Erection	2.1.4.6	Completion of Earth work, Fencing foundation work, Trenching & dewatering & Drainage work	7.7			Review and Acceptance of System Acceptance Test Report by the Engineer
		2.1.4.7	Construction of Control Room Building and its E&M works i.e. Building electrification, ventilation and switch yard lighting system	1.5			
		2.1.4.8	Erection of Steel structures and SPS	0.3			
		2.1.4.9	Erection of Auto Transformers and LT Supply Transformers as required	2.6			
		2.1.4.10	Erection of Switchgears and Control gears , Circuit Breaker, interrupters and isolators etc. as required	0.2			

Cost Centre	Item of work	Sub-Cost Centre	Stage Payment (Stage to be completed to qualify for Payment of Sub-Cost Centre)	Weightage (%)	Cost	Payment Procedure
(1)	(2)	(3)	(4)	(5)	(6)	(7)
		2.1.4.11	Erection of Control and Relay Panel and other protection, control & monitoring equipment and Control Cabling.	0.3		
		2.1.4.12	Erection/ completion of all other indoor/ outdoor equipment and balance works including Bus-bars, Earth Mats, Earthing & bonding, Lightning Protection, Fire Detection & Suppression, Power Distribution Boards Cabling, Battery, Battery Chargers, Signage & Safety Equipment etc. as required for commissioning of Power supply installations	2.4		
	System Acceptance test	2.1.4.13	System Acceptance Testing & commissioning of power supply Installations, Other Facilities and Energisation	4		Review and Acceptance of System Acceptance Test Report by the Engineer
			TOTAL	100%		

Note:

1. Adjustment to Contract Price pursuant to GCC 13.8 shall be applicable to the payments of Works executed under this Cost Centre / Price Schedule.
2. Payment will be made on Pro-rata completion of each Payment Stage as per Weightage(s) given in this Schedule.

PRICE SCHEDULE 2.1.5

Apportionment of Contract Price for Payment of Cost Centre SCADA WORKS

(Sub-clause 14.4, GC)

Cost Centre	Item of work	Sub-Cost Centre	Stage Payment (Stage to be completed to qualify for Payment of Sub-Cost Centre)	Weightage (%)	Cost	Payment Procedure
(1)	(2)	(3)	(4)	(5)	(6)	(7)
2.1.5 [SCADA Works]	Supply, installation and commissioning	2.1.5.1	Supply of RTUs along with associated accessories at Switching posts	14	1 % of the Cost Centre 2.1 (Apportionment of Contract Price for Electrical Works)	On supply of material at site as per approved quantity duly inspected by the appropriate authority and verified by the Engineer
		2.1.5.2	Augmentation of SCADA System Hardware along with associated equipment / materials at OCC	60		
		2.1.5.3	Installation of Software for SCADA System	20		
		2.1.5.4	System Acceptance Testing and Commissioning of SCADA System	6		
			TOTAL		100%	
						Review and Acceptance of System acceptance Test Report by the Engineer

Note:

1. Adjustment to Contract Price pursuant to GCC 13.8 shall be applicable to the payments of Works executed under this Cost Centre / Price Schedule.
2. Payment will be made on Pro-rata completion of each Payment Stage as per Weightage(s) given in this Schedule.

PRICE SCHEDULE 2.1.6

Apportionment of Contract Price for Payment of Cost Centre **E&M WORKS**

(Sub-clause 14.4, GC)

Cost Centre	Item of work	Sub-Cost Centre	Stage Payment (Stage to be completed to qualify for Payment of Sub-Cost Centre)	Weightage (%)	Cost	Payment Procedure
(1)	(2)	(3)	(4)	(5)	(6)	(7)
2.1.6 E&M Works	Supply & Installation	2.1.6.1	Supply and Installation of 11KV Sub-stations at Stations and Depots including Construction of Control Building, HT room including the HT Metering, Control and protection Equipment etc.	26	2% of the Cost Centre 2.1 (Apportionment of Contract Price for Electrical Works)	Review and Acceptance of Installation Test Report by the Engineer
		2.1.6.2	Supply and Installation of LT Power Distribution panels & Switch Boards at Stations & Depot including construction of LT power Control Building, LT Metering room etc. as required	7		
		2.1.6.3	Supply and Installation of Silent DG sets at Stations and Depots including the Construction of Enclosures/ Fencing / DG Room as required	6.8		
		2.1.6.4	Supply and installation of Solar system at Stations and Depot	2		
		2.1.6.5	Supply and Installation of balance E&M works as described in PS including Auxiliary Power Monitoring & control SCADA system at Stations, Depots and Service Buildings (excluding that for TSS and SSPs as covered elsewhere).	25		
		2.1.6.6	Supply and installation of E&M works for Residential Buildings constructed by other Designated Contractor	4		

Cost Centre	Item of work	Sub-Cost Centre	Stage Payment (Stage to be completed to qualify for Payment of Sub-Cost Centre)	Weightage (%)	Cost	Payment Procedure
(1)	(2)	(3)	(4)	(5)	(6)	(7)
		2.1.6.7	Automation of water pumping installations. The pump and the building will be provided by the other Contractor.	0.7		Review and Acceptance of Installation Test Report by the Engineer
		2.1.6.8	Earthing, Bonding and lightning protection system including Main earth Terminals, Clean earth terminals of Power Supply installation 11kV and below at above Service Buildings and at stations.	1.5		Review and Acceptance of Installation Test Report by the Engineer
		2.1.6.9	Supply and Installation of Ventilation and air conditioning of Stations, Service, Service Building and Depots as required	3		Review and Acceptance of Installation Test Report by the Engineer
		2.1.6.10	Supply and Installation of Parallel Redundant Uninterrupted Power Supply (UPS) system at, Stations, Depots and Power Supply Control Posts etc. as required	20		Review and Acceptance of Installation Test Report by the Engineer
	System Acceptance Test	2.1.6.11	System Acceptance Testing and Commissioning of E&M works at Station Buildings, IMSDs, TSS and SSP etc.	4		Review and Acceptance of System Acceptance Test Report by the Engineer
			TOTAL	100%		

Note:

1. The Facilities, E&M services shall be as described in PS and the Scheme drawings enclosed with the Bid Document
2. Payment will be made on Pro-rata completion of each Payment Stage as per Weightage(s) given in this Schedule.
3. Adjustment to Contract Price pursuant to GCC 13.8 shall be applicable to the payments of Works executed under this Cost Centre / Price Schedule.

PRICE SCHEDULE 2.1.7

Apportionment of Contract Price for Payment of Cost Centre SUPPLY OF SPARES AND TOOLS & INSTRUMENTS

(Sub-clause 14.4, GC)

Cost Centre	Item of work	Sub-Cost Centre	Stage Payment (Stage to be completed to qualify for Payment of Sub-Cost Centre)	Weightage (%)	Cost	Payment Procedure
(1)	(2)	(3)	(4)	(5)	(6)	(7)
2.1.7 [Supply of Spares, Tools & Instruments]	Supply	2.1.7.1	Supply of Spares for OHE:		3% of the Cost Centre 2.1 (Apportionment of Contract Price for Electrical Works)	On Supply of Contract Spares to the Employer as per approved list duly inspected by the appropriate authority and approved by the Engineer
		(a)	OHE Conductors, Jumpers droppers and OHE Fittings etc.	20		
		(b)	Structures	10		
		(c)	Cantilevers with Insulators	10		
		(d)	Balance items	5		
		2.1.7.2	Supply of Spares for Traction Power Installations:			
		(a)	Auto Transformers	15		
		(b)	Interruptioners	10		
		(c)	Circuit Breakers	10		
		(d)	Isolators	5		
		(e)	Balance items	5		
		2.1.7.3	a) Supply of Special Tools & Instruments / Equipment	9		
			b) Supply of Portable diagnostic modules for SCADA	1		
			TOTAL	100%		

Note:

1. Adjustment to Contract Price pursuant to GCC 13.8 shall be applicable to the payments of Works executed under this Cost Centre / Price Schedule.
2. Payment will be made on completion of each Payment Stage as per weightage(s) given in this Schedule

PRICE SCHEDULE 2.1.8

Apportionment of Contract Price for Payment of Cost Centre

INTEGRATED TESTING AND COMMISSIONING

(Sub-clause 14.4, GC)

Cost Centre	Item of work	Sub-Cost Centre	Stage Payment (Stage to be completed to qualify for Payment of Sub-Cost Centre)	Weightage (%)	Cost	Payment Procedure
(1)	(2)	(3)	(4)	(5)	(6)	(7)
2.1.9 [Integrated Testing And Commissioning]	Integrated Testing and Commissioning	2.1.8.1	Completion of Integrated Testing and Commissioning as required for successful commercial operation of Freight services to demonstrate the compatibility of Traction system & associated works with those of other Contractors	60	4% of the Cost Centre 2.1 (Apportionment of Contract Price) for Electrical Works	Review and Acceptance of Integrated Testing & Commissioning report by the Engineer
		2.1.8.2	Final Taking over of Complete Works.	40		Issue of Taking over certificate by the Engineer
				TOTAL	100%	

Notes:

1. Adjustment to Contract Price pursuant to GCC 13.8 shall NOT be applicable to the payments of Works executed under this Cost Centre / Price Schedule.
2. Payment will be made on completion of each Payment Stage as per weightage(s) given in this Schedule.

PRICE SCHEDULE 2.2

Apportionment of Contract Price for SIGNALLING WORKS – COST CENTRE 2.2

(Sub-clause 14.4, GC)

Price Schedule	No.	Cost Centre	Weightage of Cost Centre 2.2 (%)	Cost
(1)	(2)	(3)	(4)	(5)
2.2 [Signalling Works]	2.2.1	Design and Documentation	5	% as applicable for Cost Centre 2.0 of Apportionment of Contract Price.
	2.2.2	Signalling Works at the Junction Station	26	
	2.2.3	Signalling Works in Automatic Block Sections	44	
	2.2.4	Train Management System (TMS) and Service and Diagnostic System (S&D)	10	
	2.2.5	Supply of Contract Spares and Special Tools & Test Equipment	10	
	2.2.6	Integrated Testing & Commissioning and Final Taking-Over	4	
	2.2.7	Training	1	
		Total		

PRICE SCHEDULE 2.2.1

Apportionment of Contract Price for Payment of Cost Centre **DESIGN AND DOCUMENTATION**

(Sub-clause 14.4, GC)

Cost Centre	Item of work	Sub-Cost Centre	Stage Payment (Stage to be completed to qualify for Payment of Sub-Cost Centre)	Weightage (%)	Cost	Payment Procedure
(1)	(2)	(3)	(4)	(5)	(6)	(7)
2.2.1 [Design and Documentation]	Design and Documentation	2.2.1.1	Submission of Management Plans	5	5% of the Cost Centre 2.2 (Apportionment of Contract Price) for Signalling Works	After Review / Approval with or without comments by the Engineer
		2.2.1.2	Submission of Safety Assurance Plans & Documents	10		
		2.2.1.3	Submission of Preliminary Designs & Documents	15		
		2.2.1.4	Submission of Detailed Designs & Documents	30		
		2.2.1.5	Submission of Construction /Installation Designs & Documents	10		
		2.2.1.6	Submission of As Built Documents	20		
		2.2.1.7	Submission of O & M Manuals	10		
			TOTAL		100%	

Note:

1. Adjustment to Contract Price pursuant to GCC 13.8 shall NOT be applicable to the payments of Works executed under this Cost Centre / Price Schedule.
2. Payment will be made on Pro-rata completion of each Payment Stage as per weightage(s) given in this schedule.

PRICE SCHEDULE 2.2.2

Apportionment of Contract Price for Payment of Cost Centre **SIGNALLING WORKS AT THE JUNCTION STATION**

(Sub-clause 14.4, GC)

Cost Centre	Item of work	Sub-Cost Centre	Stage Payment (Stage to be completed to qualify for Payment of Sub-Cost Centre)	Weightage (%)	Cost	Payment Procedure
(1)	(2)	(3)	(4)	(5)	(6)	(7)
2.2.2 [Signalling Works at the Junction Station]	Supply of material	2.2.2.1	Supply of Signalling cable, Power cable and Quad Cable	20	26 % of the Cost Centre 2.2 (Apportionment of Contract Price) for Signalling Works	On supply of material at site as per approved quantity duly inspected by the appropriate authority and verified by the Engineer
		2.2.2.2	Supply of EI hardware equipment along with associated System software and accessories	14		
		2.2.2.3	Supply of power supply equipment and batteries along with associated accessories	2		
		2.2.2.4	Supply of Track Vacancy Detection hardware equipment along with associated System software and accessories	20		
		2.2.2.5	Supply of Signals and Point Machines along with associated accessories	5		
		2.2.2.6	Supply of equipment for Block/Slot Working	3		
		2.2.2.7	Supply of balance indoor equipment	1		
		2.2.2.8	Supply of balance outdoor equipment	1		

Cost Centre	Item of work	Sub-Cost Centre	Stage Payment (Stage to be completed to qualify for Payment of Sub-Cost Centre)	Weightage (%)	Cost	Payment Procedure
(1)	(2)	(3)	(4)	(5)	(6)	(7)
	Installation	2.2.2.9	Laying, Termination & Testing of outdoor cables	7		Review and Acceptance of installation test report by the Engineer
		2.2.2.10	Installation of all indoor equipment	7		
		2.2.2.11	Installation of all outdoor equipment	5		
		2.2.2.12	Supply and Installation of Earthing, Surge and Lightning Protection equipment for complete works	5		
	Any other item	2.2.2.13	Any other item required to be supplied, installed and tested for complete works within the existing scope of work	1		Review and Acceptance by the Engineer
	System acceptance test	2.2.2.14	Supply and installation of Application software and System Acceptance Test	9		Review and Acceptance of System Acceptance Test Report by the Engineer.
			TOTAL	100%		

Note:

1. The Signalling Works at Junction Station shall cover the length from First Stop Signal to Last Stop Signal including controlling track sections in both direction and the signalling works on lines connecting EDFC to WDFC and EDFC to IR Dadri (ICD)-Dadri area.
2. Payment will be made on Pro-rata completion of each Payment Stage as per weightage(s) given in this schedule.
3. Adjustment to Contract Price pursuant to GCC 13.8 shall be applicable to the payments of Works executed under this Cost Centre / Price Schedule.

4. Item 2.1.2.13 will be deemed to have been executed after successful Integrated testing and commissioning.

PRICE SCHEDULE 2.2.3

Apportionment of Contract Price for Payment of Cost Centre SIGNALLING WORKS IN AUTOMATIC BLOCK SECTIONS

(Sub-clause 14.4, GC)

Cost Centre	Item of work	Sub-Cost Centre	Stage Payment (Stage to be completed to qualify for Payment of Sub-Cost Centre)	Weightage (%)	Cost	Payment Procedure
(1)	(2)	(3)	(4)	(5)	(6)	(7)
2.2.3 [Signalling Works in Automatic Block Sections]	Supply of material	2.2.3.1	Supply of Signalling cable, Power cable and Quad Cable	26	44 % of the Cost Centre 2.2 (Apportionment of Contract Price) for Signalling Works Stage payment will be made proportionally for the track kilometers completed by the contractor.	On supply of material at site as per approved quantity duly inspected by the appropriate authority and verified by the Engineer
		2.2.3.2	Supply of EI hardware equipment along with associated System software and accessories	9		
		2.2.3.3	Supply of power supply equipment and batteries along with associated accessories	2		
		2.2.3.4	Supply of Track Vacancy detection hardware equipment along with associated System software and accessories	19		
		2.2.3.5	Supply of signals along with associated accessories	1		
		2.2.3.6	Supply of balance indoor equipment	2		
		2.2.3.7	Supply of balance outdoor equipment	2		
	Installation	2.2.3.8	Laying, Termination & Testing of outdoor cables	8		Review and Acceptance of installation test report by the Engineer
		2.2.3.9	Installation of all indoor equipment	7		
		2.2.3.10	Installation of all outdoor equipment	5		

Cost Centre	Item of work	Sub-Cost Centre	Stage Payment (Stage to be completed to qualify for Payment of Sub-Cost Centre)	Weightage (%)	Cost	Payment Procedure
(1)	(2)	(3)	(4)	(5)	(6)	(7)
	Installation	2.2.3.11	Supply and installation of Earthing, Surge and Lightning Protection equipment for complete works	5		Review and Acceptance of Installation Test Report by the Engineer
	Any other item	2.2.3.12	Any other item required to be supplied, installed and tested for complete works within the existing scope of work.	1		Review and Acceptance by the Engineer
	Buildings & Structures for Signalling Works	2.2.3.13	Completion of all civil works for the Buildings & Structures works for Signalling Works	3		Acceptance of the civil works by the Engineer
		2.2.3.14	Completion of all other E & M works	1		Issue of completion certificate for the Buildings and Structures by the Engineer
	System acceptance test	2.2.3.15	Supply and installation of Application software and System Acceptance Test	9		Review and Acceptance of System Acceptance Test Report by the Engineer.
			TOTAL	100%		

Note:

1. Payment will be made on Pro-rata completion of each Payment Stage as per weightage(s) given in this schedule.
2. Payment against sub cost centre 2.2.3.13 and 2.2.3.14 will be made based prorate completion of square metre (sqm) of built up area.
3. Adjustment to Contract Price pursuant to GCC 13.8 shall be applicable to the payments of Works executed under this Cost Centre / Price Schedule.
4. Item No. 2.2.3.12 will be deemed to have been executed after successful integrated testing and commissioning.

PRICE SCHEDULE 2.2.4

Apportionment of Contract Price for Payment of Cost Centre TRAIN MANAGEMENT SYSTEM (TMS) AND SERVICE AND DIAGNOSTICS SYSTEM (S&D)

(Sub-clause 14.4, GC)

Cost Centre	Item of work	Sub-Cost Centre	Stage Payment (Stage to be completed to qualify for Payment of Sub-Cost Centre)	Weightage (%)	Cost	Payment Procedure
(1)	(2)	(3)	(4)	(5)	(6)	(7)
2.2.4 [Train Management System (TMS)] and Service and Diagnostic System	Supply of material	2.2.4.1	Augmentation of TMS hardware equipment along with associated Cables, associated software & accessories at OCC	1	10% of the Cost Centre 2.2 (Apportionment of Contract Price) for Signalling Works	On supply of material at site as per approved quantity duly inspected by the appropriate authority and verified by the Engineer
		2.2.4.2	Supply of TMS hardware equipment along with associated Cables, associated software & accessories for locations other than OCC	15		
		2.2.4.3	Augmentation of power supply equipment and batteries along with associated accessories at OCC	1		
		2.2.4.4	Supply of video wall display system along with associated accessories for TMS and SCADA at OCC	21		
		2.2.4.5	Augmentation of Service and Diagnostic System hardware equipment along with associated Cables and accessories at OCC – Server, Switches, CMU, FEP, Monitors etc.	1		

Cost Centre	Item of work	Sub-Cost Centre	Stage Payment (Stage to be completed to qualify for Payment of Sub-Cost Centre)	Weightage (%)	Cost	Payment Procedure
(1)	(2)	(3)	(4)	(5)	(6)	(7)
		2.2.4.6	Supply of Service and Diagnostic System hardware equipment along with associated Cables and accessories for Stations and Auto Locations Huts- Data Logger, Data Concentrator, HMU for battery, Power Supply, Signal, Points and MSDAC etc.	21		Review and Acceptance of Installation Test Report by the Engineer
		2.2.4.7	Supply of balance equipment for TMS	1		
		2.2.4.8	Supply of balance equipment for S&D System	1		
	Installation	2.2.4.9	Installation of all TMS equipment including Video Wall Display System at OCC	6		
		2.2.4.10	Installation of all TMS equipment at locations other than OCC	3		
		2.2.4.11	Installation of all equipment for S&D system at OCC	3		
		2.2.4.12	Installation of all equipment for S&D system at stations and Auto Location Huts	6		
		2.2.4.13	Supply and installation of Earthing, Surge and Lightning Protection equipment for complete works.	3		

Cost Centre	Item of work	Sub-Cost Centre	Stage Payment (Stage to be completed to qualify for Payment of Sub-Cost Centre)	Weightage (%)	Cost	Payment Procedure
(1)	(2)	(3)	(4)	(5)	(6)	(7)
	Any other item	2.2.4.14	Any other item required to be supplied, installed and tested for complete works within the existing scope of work.	1		Review and Acceptance by the Engineer
	System acceptance test	2.2.4.15	Supply and installation of software and System Acceptance Test for TMS	10		Review and Acceptance of System Acceptance Test Report by the Engineer
		2.2.4.16	Supply and installation of software and System Acceptance Test for S&D system	6		
			TOTAL	100%		

Note:

1. Payment will be made on completion of each Payment Stage as per weightage(s) given in this schedule.
2. Adjustment to Contract Price pursuant to GCC 13.8 shall be applicable to the payments of Works executed under this Cost Centre / Price Schedule.
3. Item 2.2.4.14 will be deemed to have been executed after successful Integrated testing and commissioning.

PRICE SCHEDULE 2.2.5

Apportionment of Contract Price for Payment of Cost Centre SUPPLY OF CONTRACT SPARES AND SPECIAL TOOLS & TEST EQUIPMENT

(Sub-clause 14.4, GC)

Cost Centre	Item of work	Sub-Cost Centre	Stage Payment (Stage to be completed to qualify for Payment of Sub-Cost Centre)	Weightage (%)	Cost	Payment Procedure
(1)	(2)	(3)	(4)	(5)	(6)	(7)
2.2.5 [Supply of Contract Spares and Special Tools & Test equipment]	Contract Spares	2.2.5.1	Supply of Contract Spares for;		10 % of the Cost Centre 2.2 (Apportionment of Contract Price) for Signalling Works	On Supply of 'Contract Spares, Special Tools & Test Equipment to the Employer as per approved list duly inspected by the appropriate authority and approved by the Engineer
		(a)	Cables and Wires-All types	15		
		(b)	Electronic Interlocking-Cards, Modules complete with interconnecting cables & connectors, Control Terminal and all other associated accessories	15		
		(c)	Power Supply-Cards, Modules, Equipment complete with interconnecting cables & connectors and all other associated accessories	5		
		(d)	Digital Axle Counter-Track Devices, Track Side Electronic equipment, Evaluator equipment, Evaluator Cards, Modules complete with interconnecting cables & connectors and all other associated accessories	25		

Cost Centre	Item of work	Sub-Cost Centre	Stage Payment (Stage to be completed to qualify for Payment of Sub-Cost Centre)	Weightage (%)	Cost	Payment Procedure
(1)	(2)	(3)	(4)	(5)	(6)	(7)
		(e)	Signals and Point Machines	5		
		(f)	TMS and S&D system	10		
		(g)	Balance items/ equipment/material	5		
	Special Tools & Test equipment	2.2.5.2	Supply of Special Tools & Test equipment	20		
			TOTAL	100%		

Note:

1. Payment will be made on completion of each Payment Stage as per weightage(s) given in this schedule.
2. Adjustment to Contract Price pursuant to GCC 13.8 shall be applicable to the payments of Works executed under this Cost Centre / Price Schedule.

PRICE SCHEDULE 2.2.6

Apportionment of Contract Price for Payment of Cost Centre

INTEGRATED TESTING & COMMISSIONING AND FINAL TAKING-OVER

(Sub-clause 14.4, GC)

Cost Centre	Item of work	Sub-Cost Centre	Stage Payment (Stage to be completed to qualify for Payment of Sub-Cost Centre)	Weightage (%)	Cost	Payment Procedure
(1)	(2)	(3)	(4)	(5)	(6)	(7)
2.2.6 [Integrated Testing & Commissioning and Final Taking-Over]	Integrated Testing & Commissioning and Final Taking-Over	2.2.6.1	Successful Completion of Integrated Testing & Commissioning	50	4 % of the Cost Centre 2.2 (Apportionment of Contract Price) for Signalling Works	Review and Acceptance of Integrated Testing & Commissioning reports by the Engineer
		2.2.6.2	Final Taking-Over Certificate for the complete work	50		Issue of Taking over Certificate by the Engineer
			TOTAL		100%	

Note:

1. Adjustment to Contract Price pursuant to GCC 13.8 shall not be applicable to the payments of Works executed under this Cost Centre / Price Schedule.

2. Payment will be made on completion of each Payment Stage as per weightage(s) given in this schedule.

PRICE SCHEDULE 2.2.7

Apportionment of Contract Price for Payment of Cost Centre

TRAINING

(Sub-clause 14.4, GC)

Cost Centre	Item of work	Sub-Cost Centre	Stage Payment (Stage to be completed to qualify for Payment of Sub-Cost Centre)	Weightage (%)	Cost	Payment Procedure
(1)	(2)	(3)	(4)	(5)	(6)	(7)
2.2.7 [Training]	Training	2.2.7.1	Training	100	1 % of the Cost Centre 2.2 (Apportionment of Contract Price) for Signalling Works	On completion of Training as per approved Training Plan and submission of Training Manuals duly reviewed and/or approved by the Engineer
			TOTAL	100%		

Note:

- Adjustment to Contract Price pursuant to GCC 13.8 shall not be applicable to the payments of Works executed under this Cost Centre / Price Schedule.

PRICE SCHEDULE 2.3

Apportionment of Contract Price for TELECOMMUNICATION WORKS – COST CENTRE 2.3

(Sub-clause 14.4, GC)

Price Schedule	No.	Cost Centre	Weightage of Cost Centre 2.3 (%)	Cost
(1)	(2)	(3)	(4)	(5)
2.3 [Telecommunication Works]	2.3.1	Design and Documentation	10	% as applicable for Cost Centre 2.0 of Apportionment of Contract Price.
	2.3.2	Telecom Works at 1 Junction station	24	
	2.3.3	Telecom works at Operational Control Centre (OCC)	4	
	2.3.4	Telecom works in Automatic Block Sections	40	
	2.3.5	Integrated Testing & Commissioning and Final Taking-Over	8	
	2.3.6	Contract Spares	6	
	2.3.7	Special Tools & Test Equipment	4	
	2.3.8	Training	4	
		Total		

PRICE SCHEDULE 2.3.1

Apportionment of Contract Price for Payment of Cost Centre DESIGN AND DOCUMENTATION

(Sub-clause 14.4, GC)

Cost Centre	Item of work	Sub-Cost Centre	Stage Payment (Stage to be completed to qualify for Payment of Sub-Cost Centre)	Weightage (%)	Cost	Payment Procedure
(1)	(2)	(3)	(4)	(5)	(6)	(7)
2.3.1 [Design and Documentation]	Management Plan	2.3.1.1	Project Management Plan, Quality Management Plan, Quality Assurance Plan, Site Safety Plan, Design Plan	10	10 % of the Cost Centre 2.3 (Apportionment of Contract Price) for Telecommunication Works	After review and approval with or without comments by the Engineer
		2.3.1.2	Reliability Plan, Maintainability Plan, Interface Management Plan, EMC Management Plan, Procurement, Manufacturing & Supply Plan, Software Support Plan, Factory Acceptance Testing Plan, Construction and Installation Management Plan, On-site Testing & Commissioning Plan	10		
		2.3.1.3	Operation & Maintenance Plan, Training Plan, Spare Parts & Consumable Management Plan, Defect Liability Management Plan, Maintenance Manpower Plan, Trial Run Plan	5		
	2.3.1.4	All Preliminary Design Documents including RAMS Documents	10			
	2.3.1.5	All Detailed Design Documents including EMC Documents & Interface	15			
Design Documents						

Cost Centre	Item of work	Sub-Cost Centre	Stage Payment (Stage to be completed to qualify for Payment of Sub-Cost Centre)	Weightage (%)	Cost	Payment Procedure
(1)	(2)	(3)	(4)	(5)	(6)	(7)
			Specification for complete works.			
		2.3.1.6	All Installation Design Documents for Complete Works	10		
	O&M Manuals	2.3.1.7	O&M Manual for Completed Works	15		
	As-Built Drawings	2.3.1.8	As-Built Drawings for Completed Works	20		
	Any other document	2.3.1.9	Balance documents required to be given as part of the Contract	5		
			TOTAL	100%		

Note:

1. Adjustment to Contract Price pursuant to GCC 13.8 shall not be applicable to the payments of Works executed under this Cost Centre / Price Schedule.
2. Payment will be made on completion of each Payment Stage as per weightage(s) given in this schedule.

PRICE SCHEDULE 2.3.2

Apportionment of Contract Price for Payment of Cost Centre TELECOM WORKS AT 1 JUNCTION STATION

(Sub-clause 14.4, GC)

Cost Centre	Item of work	Sub-Cost Centre	Stage Payment (Stage to be completed to qualify for Payment of Sub-Cost Centre)	Weightage (%)	Cost	Payment Procedure
(1)	(2)	(3)	(4)	(5)	(6)	(7)
2.3.2 [Telecom Works at the Junction station]	Supply of material	2.3.2.1	Supply of PIJF Telephone Cables	5	24% of the Cost Centre 2.3 (Apportionment of Contract Price for Telecommunication Works	On supply of material at site as per approved quantity duly inspected by the appropriate authority and verified by the Engineer
		2.3.2.2	Supply of OFC System Hardware along with associated software & accessories.	25		
		2.3.2.3	Supply of Data Networking System Hardware along with associated software & accessories.	10		
		2.3.2.4	Supply of Telephone System Hardware along with associated software & accessories	15		
		2.3.2.5	Supply of Master Clock System Hardware along with associated software & accessories.	2		
		2.3.2.6	Supply of VHF communication System Hardware along with associated software & accessories.	4		
		2.3.2.7	Supply of 48 V DC Battery Backup System Hardware along with associated software & accessories.	10		
		2.3.2.8	Supply of balance Indoor and Outdoor equipment.	4		

Cost Centre	Item of work	Sub-Cost Centre	Stage Payment (Stage to be completed to qualify for Payment of Sub-Cost Centre)	Weightage (%)	Cost	Payment Procedure
(1)	(2)	(3)	(4)	(5)	(6)	(7)
	Installation	2.3.2.9	Installation of all indoor equipment	5		Review and Acceptance of Installation Test Report by the Engineer
		2.3.2.10	Installation of all outdoor equipment	5		
		2.3.2.11	Laying, Termination & Testing of Outdoor Telecom Cables	5		
		2.3.2.12	Installation of Earthing and Surge Protection equipment	5		
	System acceptance test	2.3.2.13	Supply and installation of software and System Acceptance Test	5		Review and Acceptance of System Acceptance Test Report by the Engineer
			TOTAL	100%		

Note:

1. Telecom Works at Junction Stations shall also include Telecom works up to the IMSD and Residential Colonies.
2. Telecom Works at Junction shall also include Telecom Works at New Khurja and Dadri.
3. Payment will be made on Pro-rata completion of each Payment Stage as per weightage(s) given in this schedule.
4. Adjustment to Contract Price pursuant to GCC 13.8 shall be applicable to the payments of Works executed under this Cost Centre / Price Schedule.

PRICE SCHEDULE 2.3.3

Apportionment of Contract Price for Payment of Cost Centre TELECOM WORKS AT OPERATIONAL CONTROL CENTRE (OCC)

(Sub-clause 14.4, GC)

Cost Centre	Item of work	Sub-Cost Centre	Stage Payment (Stage to be completed to qualify for Payment of Sub-Cost Centre)	Weightage (%)	Cost	Payment Procedure
(1)	(2)	(3)	(4)	(5)	(6)	(7)
2.3.3 [Telecom works at Operational Control Centre (OCC)]	Supply of material	2.3.3.1	Supply of PIJF Telephone Cables	5	4 % of the Cost Centre 2.3 (Apportionment of Contract Price for Telecommunication Works)	On supply of material at site as per approved quantity duly inspected by the appropriate authority and verified by the Engineer
		2.3.3.2	Supply of OFC System Hardware along with associated software & accessories.	18		
		2.3.3.3	Supply of Data Networking System Hardware along with associated software & accessories.	18		
		2.3.3.4	Supply of Telephone System Hardware along with associated software & accessories.	10		
		2.3.3.5	Supply of Master Clock System Hardware along with associated software & accessories.	4		
		2.3.3.6	Supply of MTRC System Hardware along with associated accessories	10		

Cost Centre	Item of work	Sub-Cost Centre	Stage Payment (Stage to be completed to qualify for Payment of Sub-Cost Centre)	Weightage (%)	Cost	Payment Procedure
(1)	(2)	(3)	(4)	(5)	(6)	(7)
		2.3.3.7	Supply of balance Indoor and Outdoor equipment	5		
	Installation	2.3.3.8	Installation of all indoor equipment	10		Review and Acceptance of Installation Test Report by the Engineer
	Installation	2.3.3.9	Installation of Earthing and Surge Protection equipment	4		Review and Acceptance of Installation Test Report by the Engineer
	System acceptance test	2.3.3.10	Supply and installation of software and System Acceptance Test	16		Review and Acceptance of System Acceptance Test Report by the Engineer
			TOTAL	100%		

Note:

1. Payment will be made on completion of each Payment Stage as per weightage(s) given in this schedule.
2. Adjustment to Contract Price pursuant to GCC 13.8 shall be applicable to the payments of Works executed under this Cost Centre / Price Schedule.

PRICE SCHEDULE 2.3.4

Apportionment of Contract Price for Payment of Cost Centre TELECOM WORKS IN AUTOMATIC BLOCK SECTIONS & SINGLE LINE SECTIONS

(Sub-clause 14.4, GC)

Cost Centre	Item of work	Sub-Cost Centre	Stage Payment (Stage to be completed to qualify for Payment of Sub-Cost Centre)	Weightage (%)	Cost	Payment Procedure
(1)	(2)	(3)	(4)	(5)	(6)	(7)
2.3.4 [Telecom works in Automatic Block Sections Sections]	Supply of material	2.3.4.1	Supply of Optic Fibre Cables & HDPE Duct	20	40% of the Cost Centre 2.3 (Apportionment of Contract Price) for Telecommunication Works Stage payment will be made proportionally for the track kilometers completed by the contractor	On supply of material at site as per approved quantity duly inspected by the appropriate authority and verified by the Engineer
		2.3.4.2	Supply of OFC System Hardware along with associated software & accessories	10		
		2.3.4.3	Supply of Cab Radio complete with power supply, battery pack, antenna, software & accessories	3		
		2.3.4.4	Supply of OPH & GPH complete with accessories, battery pack and carry case and 100% spare batteries	2		
		2.3.4.5	Supply of Radio Towers complete with antenna, cables, aviation lighting, Earthing etc.	10		
		2.3.4.6	Supply of BSS System Hardware along with associated accessories for MTRC	15		

Cost Centre	Item of work	Sub-Cost Centre	Stage Payment (Stage to be completed to qualify for Payment of Sub-Cost Centre)	Weightage (%)	Cost	Payment Procedure	
(1)	(2)	(3)	(4)	(5)	(6)	(7)	
		2.3.4.7	Supply of 48 V DC Battery Backup System Hardware along with associated accessories.	7			
		2.3.4.8	Supply of balance indoor & outdoor equipment	3			
	Installation	2.3.4.9	Installation of all indoor equipment	5			Review and Acceptance of Installation Test Report by the Engineer
		2.3.4.10	Installation of all outdoor equipment	5			
		2.3.4.11	Laying, Termination & Testing of Outdoor Telecom Cables	10			
	Installation	2.3.4.12	Installation of Earthing and Surge Protection equipment	5			Review and Acceptance of Installation Test Report by the Engineer
	System acceptance test	2.3.4.13	System Acceptance Test	5			Review and Acceptance of System Acceptance Test Report by the Engineer
			TOTAL	100%			

Notes:

1. Telecom Works in Automatic Block Sections shall cover all Telecom Works between New Khurja and New Boraki, New Boraki-Dadri and up to boundary between EDFC and WDFC and shall also include Telecom Works at TSS, SSP and other Buildings.
2. Payment will be made on Pro-rata completion of each Payment Stage as per weightage(s) given in this schedule.
3. Adjustment to Contract Price pursuant to GCC 13.8 shall be applicable to the payments of Works executed under this Cost Centre / Price Schedule.

PRICE SCHEDULE 2.3.5

Apportionment of Contract Price for Payment of Cost Centre INTEGRATED TESTING & COMMISSIONING AND FINAL TAKING-OVER

(Sub-clause 14.4, GC)

Cost Centre	Item of work	Sub-Cost Centre	Stage Payment (Stage to be completed to qualify for Payment of Sub-Cost Centre)	Weightage (%)	Cost	Payment Procedure
(1)	(2)	(3)	(4)	(5)	(6)	(7)
2.3.5 [Integrated Testing & Commissioning and Final Taking-Over]	Integrated Testing & Commissioning and Final Taking-Over	2.3.5.1	Successful Completion of Integrated Testing & Commissioning	50	8 % of the Cost Centre 2.3 (Apportionment of Contract Price) For Telecommunication Works	Review and Acceptance of Integrated Testing & Commissioning Report by the Engineer
		2.3.5.2	Final Taking-Over Certificate for the complete work	50		Issue of Taking over Certificate by the Engineer
				TOTAL	100%	

Note:

1. Adjustment to Contract Price pursuant to GCC 13.8 shall NOT be applicable to the payments of Works executed under this Cost Centre / Price Schedule.
2. Payment will be made on completion of each Payment Stage as per weightage(s) given in this schedule.

PRICE SCHEDULE 2.3.6

Apportionment of Contract Price for Payment of Cost Centre

CONTRACT SPARES

(Sub-clause 14.4, GC)

Cost Centre	Item of work	Sub-Cost Centre	Stage Payment (Stage to be completed to qualify for Payment of Sub-Cost Centre)	Weightage (%)	Cost	Payment Procedure
(1)	(2)	(3)	(4)	(5)	(6)	(7)
2.3.6 [Contract Spares]	Contract Spares	2.3.6.1	Supply of Contract Spares along with all other associated accessories	100	6% of the Cost Centre 2.3 (Apportionment of Contract Price) For Telecommunication Works	On Supply of Contract Spares to the Employer as per approved list duly inspected by the appropriate authority and approved by the Engineer
			TOTAL	100%		

Note:

1. Adjustment to Contract Price pursuant to GCC 13.8 shall be applicable to the payments of Works executed under this Cost Centre / Price Schedule.

PRICE SCHEDULE 2.3.7

Apportionment of Contract Price for Payment of Cost Centre

SPECIAL TOOLS & TEST EQUIPMENT

(Sub-clause 14.4, GC)

Cost Centre	Item of work	Sub-Cost Centre	Stage Payment (Stage to be completed to qualify for Payment of Sub-Cost Centre)	Weightage (%)	Cost	Payment Procedure
(1)	(2)	(3)	(4)	(5)	(6)	(7)
2.3.7 [Special Tools & Test Equipment]	Special Tools and Test Equipment	2.3.7.1	Supply of Special Tools and Test Equipment along with all other associated accessories, Operation and Maintenance Manual and Calibration Certificate	100	4 % of the Cost Centre 2.3 (Apportionment of Contract Price) For Telecommunication Works	On supply of Special Tools & Test Equipment to the Employer as per approved list duly inspected by the appropriate authority and approved by the Engineer
			TOTAL	100%		

Note:

- Adjustment to Contract Price pursuant to GCC 13.8 shall be applicable to the payments of Works executed under this Cost Centre / Price Schedule.

PRICE SCHEDULE 2.3.8

Apportionment of Contract Price for Payment of Cost Centre **TRAINING**

(Sub-clause 14.4, GC)

Cost Centre	Item of work	Sub-Cost Centre	Stage Payment (Stage to be completed to qualify for Payment of Sub-Cost Centre)	Weightage (%)	Cost	Payment Procedure
(1)	(2)	(3)	(4)	(5)	(6)	(7)
2.3.8 [Training]	Training	2.3.8.1	Training	100	4% of the Cost Centre 2.3 (Apportionment of Contract Price) For Telecommunication Works	On completion of Training as per approved Training Plan and submission of Training Manuals duly reviewed and/or approved by the Engineer
			TOTAL	100%		

Note:

1. Adjustment to Contract Price pursuant to GCC 13.8 shall NOT be applicable to the payments of Works executed under this Cost Centre / Price Schedule.

Section V. Eligible Countries

Eligibility for the Provision of Goods, Works and Services in Bank-Financed Procurement

1. In accordance with Para 1.8 of the Guidelines: Procurement under IBRD Loans and IDA Credits, dated January 2011, the Bank permits firms and individuals from all countries to offer goods, works and services for Bank-financed projects. As an exception, firms of a Country or goods manufactured in a Country may be excluded if:
 - Para 1.8 (a) (i): as a matter of law or official regulation, the Borrower's Country prohibits commercial relations with that Country, provided that the Bank is satisfied that such exclusion does not preclude effective competition for the supply of the Goods or Works required, or
 - Para 1.8 (a) (ii): by an Act of Compliance with a Decision of the United Nations Security Council taken under Chapter VII of the Charter of the United Nations, the Borrower's Country prohibits any import of goods from that Country or any payments to persons or entities in that Country.
2. For the information of borrowers and bidders, at the present time firms, goods and services from the following countries are excluded from this bidding:
 - (a) With reference to paragraph 1.8 (a) (i) of the Guidelines: None
 - (b) With reference to paragraph 1.8 (a) (ii) of the Guidelines: None



**BID DOCUMENT
FOR**

DESIGN, SUPPLY, CONSTRUCTION, INSTALLATION, TESTING AND COMMISSIONING OF 2X25KV AC ELECTRIFICATION, SIGNALLING & TELECOMMUNICATION, E&M AND ASSOCIATED WORKS ON DESIGN-BUILD LUMP SUM BASIS FOR DADRI-KHURJA SECTION (APPROXIMATELY 47 ROUTE KM OF DOUBLE LINE) OF EASTERN DEDICATED FREIGHT CORRIDOR

SYSTEMS WORKS CONTRACT PACKAGE 105

Issued on: 14.06.2017

ICB No.: HQ/SYS/EC/D-B/Dadri– Khurja

EMPLOYER'S REQUIREMENTS

PART-2, SECTION-VI,

VOLUME-1: GENERAL SPECIFICATIONS

**EMPLOYER: DEDICATED FREIGHT CORRIDOR CORPORATION OF INDIA LTD
(A GOVERNMENT OF INDIA ENTERPRISE)**

MINISTRY OF RAILWAYS

COUNTRY: INDIA

Table of Contents

PART 1 – Bidding Procedures

- Section I. Instructions to Bidders
- Section II. Bid Data Sheet
- Section III. Evaluation and Qualification Criteria (Following Prequalification)
- Section IV. Bidding Forms
- Section V. Eligible countries

PART 2 – Employer's Requirements

- Section VI. Employer's Requirements

Volume 1: General Specifications

- Volume 2: Particular Specifications – 2x25 kV, AC Traction Electrification and Associated Works
- Volume 3: Particular Specifications – Signalling Works
- Volume 4: Particular Specifications – Telecommunication Works
- Volume 5: Particular Specifications – E&M and Associated Works

PART 3 – Conditions of Contract and Contract Forms

- Section VII. General Conditions (GC) As per FIDIC Yellow Book 1999-Edition
- Section VIII. Particular Conditions
 - *Appendix to Tender*
- Section IX. Contract Forms

PART 4 – Reference Documents

1. Alignment Plans, Yard Plans and Building Plans
2. Power Supply, Distribution, OHE and SCADA system Schemes & layouts and S&T Drawings
3. DFCC-Environmental Assessment Report for Khurja - Dadri Section
4. Environmental Management Framework(EMF) for EDFC
5. DFCC– Resettlement Action Plan for Khurja- Dadri Section
6. DFCC-SHE Manual
7. Specification for 12000hp locomotive and Tractive effort Curve
8. IR's Transmission line Network and DFCCIL's Traction Sub Station (TSS) Connectivity

VOLUME-1: GENERAL SPECIFICATIONS

Table of Contents

CHAPTER-1: INTRODUCTION & SCOPE	8
1.1 INTRODUCTION	8
1.2 OBJECTIVE	8
1.3 PROJECT INFORMATION FOR DADRI – KHURJA SECTION	9
1.4 CONTRACT PACKAGES FOR DADRI-KHURJA SECTION	10
1.5 CONTRACT PACKAGES FOR ADJACENT SECTION	11
1.6 SCOPE OF WORK	11
CHAPTER-2: GENERAL	13
2.1 DEFINITIONS AND INTERPRETATIONS	13
2.2 ABBREVIATIONS AND ACRONYMS	17
2.3 ARCHITECTURE OF BID DOCUMENT: PACKAGE - 105: 2X25 KV AC TRACTION ELECTRIFICATION, SIGNALLING, TELECOMMUNICATION, E&M AND ASSOCIATED WORKS	20
2.4 APPLICABILITY OF GENERAL SPECIFICATIONS AND RELEVANT DOCUMENTS	22
2.5 REFERENCE DOCUMENTS	22
2.6 CODES & STANDARDS	22
2.7 SCHEDULE OF DIMENSIONS AND CLEARANCES	22
2.8 SPECIFICATIONS	23
2.9 LANGUAGE OF CONTRACTOR'S DOCUMENTS	23
2.10 PROJECT MANAGEMENT INFORMATION SYSTEM (PMIS)	23
2.11 PATENT, COPYRIGHT OR OTHER INTELLECTUAL PROPERTY RIGHTS	23
2.12 PUBLICITY	24
2.13 GUARANTY/WARRANTY CERTIFICATES OF OEM	24
2.14 SURVEY AND SITE INVESTIGATIONS	24
2.15 ALIGNMENT & YARD PLANS ETC	24
2.16 UNITS OF MEASUREMENT	25
2.17 CLIMATIC CONDITIONS	25
CHAPTER-3: PROJECT PLANNING & MANAGEMENT	28
3.1 GENERAL	28
3.2 PROJECT MANAGEMENT PLAN	29
3.3 PROJECT ORGANIZATION PLAN	31
3.4 DOCUMENT MANAGEMENT PLAN	32
3.5 DESIGN MANAGEMENT PLAN	32
3.6 DESIGN SUBMISSION PLAN	32
3.7 SIMULATION STUDY PLAN	33
3.8 INTERFACE MANAGEMENT PLAN	33
3.9 SYSTEM ASSURANCE PLAN	34

3.10	FIRE SAFETY PLAN.....	36
3.11	VERIFICATION, VALIDATION AND DEMONSTRATION (VVD) PLAN.....	37
3.12	PROCUREMENT MANAGEMENT & MANUFACTURING PLAN.....	38
3.13	FACTORY ACCEPTANCE TEST PLAN.....	41
3.14	INSTALLATION PLAN.....	42
3.15	SITE MANAGEMENT PLAN.....	44
3.16	SITE SAFETY PLAN.....	44
3.17	HEALTH & ENVIRONMENT PLAN.....	45
3.18	TESTING & COMMISSIONING MANAGEMENT PLAN INCLUDING TRIALS AND INTEGRATED TESTING & COMMISSIONING.....	45
3.19	PERMITS AND APPROVALS PLAN.....	46
3.20	TRAINING PLAN AND TRANSFER OF TECHNOLOGY (TOT) PLAN.....	46
3.21	OPERATION & MAINTENANCE PLAN.....	46
3.22	SPARES MANAGEMENT PLAN.....	47
3.23	DEFECT LIABILITY MANAGEMENT PLAN.....	47
	CHAPTER-4: PROJECT PROGRAM REQUIREMENT.....	48
4.1	GENERAL.....	48
4.2	THE EXECUTION PHASES.....	49
4.3	WORKS PROGRAM.....	50
4.4	DESIGN SUBMISSION PROGRAM.....	52
4.5	PROCUREMENT MANAGEMENT & MANUFACTURING PROGRAM.....	53
4.6	INSTALLATION PROGRAM.....	54
4.7	TESTING & COMMISSIONING PROGRAM.....	55
4.8	TRAINING PROGRAM.....	56
4.9	THE PROJECT CALENDAR.....	56
4.10	PROGRAM SUBMISSIONS.....	56
4.11	PROGRAM REVIEW.....	56
4.12	WORKS PROGRAM REVISIONS.....	56
4.13	PROGRAM ANALYSIS REPORT.....	57
4.14	MILESTONES.....	57
4.15	MONITORING OF PROGRESS.....	58
4.16	PROGRESS REVIEW MEETINGS.....	58
4.17	MONTHLY PROGRESS REPORT.....	59
4.18	QUARTERLY REVIEW MEETINGS.....	59
4.19	IT REQUIREMENT FOR DFCCIL.....	59
	CHAPTER-5: DOCUMENT MANAGEMENT REQUIREMENT.....	61
5.1	GENERAL.....	61
5.2	TYPES OF DOCUMENTS.....	61
5.3	DOCUMENT CONTROL PROCEDURE.....	62

5.4	REQUIREMENTS OF DOCUMENT SUBMISSION.....	63
5.5	DRAWINGS TO BE SUBMITTED BY THE CONTRACTOR	64
5.6	LEVEL / QUANTUM OF SUBMISSION	64
5.7	DOCUMENT SUBMISSION PROGRAM.....	65
5.8	DOCUMENT SUBMISSION PROCEDURE.....	65
5.9	ENGINEERING REVIEW COORDINATION.....	66
5.10	ENGINEER'S REVIEW.....	67
5.11	ENGINEER'S RESPONSE	67
	CHAPTER-6: DESIGN REQUIREMENT.....	69
6.1	GENERAL.....	69
6.2	GENERAL DESIGN CRITERIA	69
6.3	OBLIGATIONS AND RESPONSIBILITIES OF THE CONTRACTOR.....	70
6.4	CONTRACTOR'S ORGANIZATION DURING DESIGN PHASE	72
6.5	EMPLOYER'S DRAWINGS & DOCUMENTS.....	73
6.6	CONTRACTOR'S REVIEW OF EMPLOYER'S DESIGN & DRAWINGS.....	74
6.7	VALIDATION OF DATA & ADDITIONAL SURVEYS.....	74
6.8	RESIDUAL & SUPPORTIVE WORKS TO DELIVER THE PERMANENT WORKS.....	75
6.9	DESIGN STAGES	75
6.10	INCEPTION REPORT WITH STUDY ON PS, GS AND STANDARDS	77
6.11	SYSTEM REQUIREMENT SPECIFICATIONS.....	77
6.12	PRELIMINARY DESIGN STAGE.....	77
6.13	DETAILED DESIGN STAGE	78
6.14	DESIGN REQUIREMENTS DURING CONSTRUCTION PHASE	80
6.15	AS-BUILT DOCUMENTS	83
6.16	DESIGN INTERFACE WITH OTHER CONTRACTORS.....	84
6.17	DESIGN SUBMISSION PROCEDURE	85
6.18	DESIGN REVIEW PROCEDURES	85
6.19	DOCUMENT & DRAWINGS SUBMISSION PROCEDURE.....	86
6.20	CALCULATIONS	87
6.21	CONTRACTOR'S WARRANTY OF DESIGN	87
	CHAPTER-7 WORK AREA MANAGEMENT.....	89
7.1	WORKS AREA.....	89
7.2	STANDARD ENGINEERING CONDITIONS	90
7.3	POSSESSION OF IR TRACKS	91
7.4	POSSESSION PERIODS	91
7.5	TEMPORARY WORKS	92
7.6	REQUIREMENT FOR CONSTRUCTION.....	92
	CHAPTER-8: MANUFACTURING, SUPPLY, INSTALLATION, TESTING & COMMISSIONING	93
8.1	GENERAL.....	93

8. 2	MANUFACTURING	93
8. 3	PACKAGING, TRANSPORTATION AND STORAGE OF PLANT AND MATERIAL	95
8. 4	INSTALLATION	98
8. 5	INSTALLATION METHOD STATEMENT	99
8. 6	MATERIALS AND WORKMANSHIP	99
8. 7	INSTALLATION MATERIAL	99
8. 8	SAMPLES	100
8. 9	MOCK-UPS	100
8. 10	DISPOSAL OF SURPLUS MATERIAL	100
8. 11	ASSET IDENTIFICATION	100
8. 12	TESTING & COMMISSIONING	101
8. 13	TESTING PHILOSOPHY	102
8. 14	TEST CERTIFICATES AND REPORTS	102
8. 15	TYPE TEST	103
8. 16	FACTORY ACCEPTANCE TEST (FAT)	103
8. 17	INSTALLATION TESTS	103
8. 18	POST-INSTALLATION TESTS	104
8. 19	SYSTEM ACCEPTANCE TESTS (SAT)	104
8. 20	SAMPLES FOR TESTING	105
8. 21	INTEGRATED TESTING	105
8. 22	COMPLETION OF TEST RESULTS	106
8. 23	FAILURE TO PASS TEST	106
8. 24	RETESTING	106
8. 25	STATUTORY REQUIREMENTS	106
8. 26	TRIAL RUN AND COMMISSIONING	106
8. 27	TESTING RECORDS	107
	CHAPTER-9: SITE SAFETY	109
9.1	GENERAL	109
9.2	CONTRACTOR'S RESPONSIBILITY FOR SAFETY	109
9.3	SITE SAFETY INSPECTIONS	109
9.4	APPOINTMENT, DUTIES AND RESPONSIBILITIES OF SAFETY STAFF	109
9.5	POLICY FOR IDENTIFYING HAZARDS	110
9.6	SAFETY OF THE EQUIPMENT	110
9.7	SAFETY AND HEALTH PROCEDURES	110
9.8	SITE SAFETY PLAN	112
9.9	HEALTH	120
	CHAPTER-10: INTERFACE MANAGEMENT	121
10.1	GENERAL	121
10.2	INTERFACE MANAGEMENT PLAN (IMP)	122

10.3	INTERFACE CO-ORDINATION DOCUMENT (ICD)	125
10.4	DEDICATED CO-ORDINATION TEAM	125
10.5	CO-ORDINATION WITH OTHER CONTRACTORS AND INDIAN RAILWAYS	125
CHAPTER-11: QUALITY ASSURANCE AND MANAGEMENT		127
11.1	GENERAL	127
11.2	SUBMISSION OF QUALITY DOCUMENTATION	127
11.3	CONTROLLED COPY OF QUALITY SYSTEM DOCUMENTATION	128
11.4	PROJECT QUALITY ASSURANCE PLAN	128
11.5	DESIGN QUALITY ASSURANCE PLAN	130
11.6	DESIGN REVIEW	130
11.7	INTERNAL AUTHORIZATION PROCESS	131
11.8	SITE QUALITY PLAN	132
11.9	MANUFACTURING MANAGEMENT AND QUALITY ASSURANCE PLANS	133
11.10	ON-SITE INSPECTION PLAN FOR RESOURCES PROCUREMENT	134
11.11	TESTS	134
11.12	SOFTWARE QUALITY ASSURANCE PROGRAM (SQAP)	135
11.13	QUALITY AUDITS	135
11.14	NOTIFICATION OF NON-CONFORMITIES	136
11.15	MONTHLY PROGRESS REPORT ON QUALITY MANAGEMENT SYSTEM	136
11.16	QUALITY RECORDS	137
CHAPTER-12: RELIABILITY, AVAILABILITY, MAINTAINABILITY & SAFETY (RAMS)		138
12.1	GENERAL	138
12.2	RELIABILITY, AVAILABILITY, MAINTAINABILITY AND SAFETY (RAMS) PLAN	139
12.3	COMPLIANCE MANAGEMENT	139
12.4	VERIFICATION & VALIDATION	140
12.5	RAMS ORGANIZATION	140
12.6	RELEVANT STANDARDS	141
12.7	SYSTEM RAM MANAGEMENT	141
12.8	SYSTEM SAFETY MANAGEMENT	145
12.9	RAM DEMONSTRATION	148
12.10	FAILURE REPORTING AND CORRECTIVE ACTION SYSTEM (FRACAS)	151
12.11	ON-SITE TESTING AND INTEGRATED SYSTEM TESTING	153
12.12	ENGINEERING SAFETY VALIDATION PLAN	154
12.13	OPERATIONAL SAFETY CASE	155
12.14	PROOF OF SAFETY	156
12.15	SYSTEM ASSURANCE DURING TRIAL RUNNING	156
12.16	SYSTEM ASSURANCE DURING REVENUE SERVICE RUNNING	157

12.17 SYSTEM ASSURANCE DURING DEFECT NOTIFICATION PERIOD (DNP).....	157
12.18 SYSTEM ASSURANCE SUBMISSIONS	158
CHAPTER-13: TRAINING	159
13.1 TRAINING REQUIREMENTS.....	159
13.2 TRAINING PLAN.....	159
13.3 TRAINING COURSES	160
13.4 TRAINING EQUIPMENT.....	162
13.5 TRAINING COURSE EVALUATION	162
CHAPTER-14: OPERATION & MAINTENANCE & SPARES	164
14.1 GENERAL	164
14.2 OPERATION & MAINTENANCE PLAN.....	164
14.3 SUPPORT DURING DEFECT NOTIFICATION PERIOD (DNP).....	165
14.4 EXTENSION OF DEFECT NOTIFICATION PERIOD.....	166
14.5 OPERATION AND MAINTENANCE (O&M) MANUALS	166
14.6 MAINTENANCE PLAN	168
14.7 MAINTENANCE SCHEDULES	169
14.8 MONTHLY MAINTENANCE MEETING	169
14.9 SOFTWARE SUPPORT.....	169
14.10 SERVICE LIFE SUPPORT	171
CHAPTER-15: APPENDICES	172
APPENDIX-1: MONTHLY PROGRESS REPORT	173
APPENDIX 2 –DRAWINGS AND CAD STANDARDS	178
APPENDIX-3: DESIGN CERTIFICATE	185
APPENDIX-4: TEMPORARY WORKS	188
APPENDIX-5: REQUIREMENT FOR CONSTRUCTION.....	193
APPENDIX-6 - ENVIRONMENTAL PROTECTION REQUIREMENTS.....	206
APPENDIX-7: PMIS REQUIREMENTS AND PROCEDURES	239
APPENDIX-8: ENVIRONMENTAL, SOCIAL, HEALTH AND SAFETY (ESHS) METRICS FOR PROGRESS REPORTS	247
APPENDIX-9: SALIENT FEATURES OF SOME MAJOR LABOUR LAWS APPLICABLE TO ESTABLISHMENTS ENGAGED IN BUILDING AND OTHER CONSTRUCTION WORK.....	250

CHAPTER-1: INTRODUCTION & SCOPE

1.1 INTRODUCTION

- 1.1.1 Dedicated Freight Corridor Corporation of India Ltd. (DFCCIL), a public sector undertaking, has been set up under the Indian Companies Act 1956 for implementation of Dedicated Freight Corridor Project. Government of India is the sole shareholder of the DFCCIL. DFCCIL has planned to construct a Dedicated Freight Corridor (DFC) on Eastern and Western Corridors. The coverage of Eastern Corridor is from Ludhiana to Dankuni and that of Western Corridor from Jawaharlal Nehru Port, Mumbai to Rewari / Tughlakabad / Dadri near Delhi. There will be a linkage between two corridors at Dadri.
- 1.1.2 Eastern DFC Route will be approximately 1847 Km long from Dankuni to Sahnewal (Ludhiana) via Dankuni – Asansol – Dhanbad – Gaya – Sonnagar – Mughalsarai – Allahabad - Kanpur – Tundla – Aligarh - Khurja - Hapur – Meerut – Saharanpur – Ambala – Sahnewal.
- 1.1.3 The section between Mughalsarai – Sahnewal (1183 km) is being financed by the World Bank.
- The section between Mughalsarai-Sonnagar (122 RKM) is Double Line Electrified Section under construction by direct funding from Ministry of Railways.
- The section between Sonnagar-Dankuni (534 RKM) will be implemented through Public Private Partnership (PPP).
- 1.1.4 EDFC Phase-1 covers the construction of double line electrified section of approximately 343 route km length between Bhaupur and Khurja and 48 route km length between Khurja and Dadri.
- 1.1.5 EDFC Phase-2 covers the construction of electrified section covering a route length of approximately 388.14 route km length (Double Line) and approximately 29.15 route km length (Single line) between Mughalsarai and New Bhaupur (excluding).
- 1.1.6 EDFC Phase-3 involves construction of single line electrified track of about 404 route km. between Khurja-Meerut-Saharanpur-Ambala-Sahnewal (near Ludhiana).
- 1.1.7 Eastern & Western Corridor have a linkage through electrified double line section running between Dadri & Khurja. The alignment of Dadri-Khurja section connecting the Eastern and Western Corridors is a double line section with an approximate length of 48 km and runs parallel to the existing IR track except for a detour at Wair with an approximate length of 5 km.
- 1.1.8 The EDFC entails construction of mostly double-track, 2x25 kV, 50 Hz, electrified railway lines. The bridges and formation will be designed for 32.5T axle load while the track structure will be designed for 25T axle load operating at train speed of up to 100 Kmph. The Eastern Corridor will handle single stack containers whereas Western Corridor is planned to cater to double stack containers.
- 1.1.9 Up-gradation of transportation technology, increase in productivity and reduction in unit transportation costs have been taken as guiding principles for formulating the project.

1.2 OBJECTIVE

- 1.2.1 The objective of this Bid Document is execution of Design, Supply, Construction, Installation, Testing and Commissioning of 2x25kV AC Electrification, Signalling &

Telecommunication, E&M and associated works for Dadri - Khurja Section of Eastern Dedicated Freight, as a Design and Build package.

1.3 PROJECT INFORMATION FOR DADRI – KHURJA SECTION

Section	Existing Railway KM		Approx. Total Route Length	Remarks
	From	To		
CP 105, Dadri - Khurja	UP Line Km – 1367.000	Km – 1413.856	UP – 48.272	UP Line: - Parallel Line – 36.636 Km - Detour Length* – 11.636 Km
	DN Line Km – 1367.900		DN – 46.292	
			EDFC-WDFC Connecting Line: UP- 0.786 DN- 0.786	EDFC-WDFC Connecting Line: UP - 786 m DN - 786 m

1.3.1 Station Buildings, Staff Quarters and, Residential Quarters, Other Service Buildings and Junction Station.

The list of Station Buildings, Staff Quarters and Other Service Buildings falling in Dadri - Khurja section and connecting IR stations are detailed below:

Type of Building	Numbers
Station buildings at Junction stations	One (New Boraki)
Residential Quarters– Type A	48
Residential Quarters– Type B	7
IMSD	One (New Boraki)

1.3.2 The aforesaid Building and Structure works of Station Buildings, and Residential Quarters as indicated in table above, will be constructed by other Contractor (s). The Conduiting for the structures required to be constructed for DFCCIL shall be done by other Contractor(s). However, all other electrification works including power supply as necessary for these buildings shall be done by the Contractor of CP-105.

1.3.3 Details Of Interfacing IR Stations

The details of the works required to be carried out at IR interfacing stations are detailed in the PS Volume 2, 3 and 4 covering the Electrical, Signalling and Telecommunication works.

1.3.4 Level Crossings

No new Level Crossing or work pertaining to extension of Level Crossings is required to be carried out under this Contract Package.

1.3.5 The salient features of the Track Structure and Formation on Khurja – Dadri Section of Eastern Dedicated Freight Corridor are as follows:

Sr.	Description	Details & Particular
1.	Gauge	1676 millimeters
2.	Main Line, Loops and Sidings	60 kg/M Rail, 1 in 12 curved thick web switches with CMS Crossings on Fan shaped PSC Sleepers layout
3.	Sleepers	PSC Mono-Block, for 60 kg rails
4.	Formation Width a) Embankment (Straight Track) b) Cuttings (Straight Track) excluding side drains	For Double line : 13500 mm minimum For Single line : 7600 mm For Double line : 13500 mm minimum For Single line : 7500 mm
5.	Radii of curves	Shall generally be not less than 700 meters on main lines (2.5 degrees)
6.	Maximum gradient	1:200 compensated
7.	Slope Gradient for Ballast Section	1.5 H:1V
8.	Cross Slope on top of formation	1 in 30
9.	Formation	As per guidelines and specifications for design formation for Heavy (32.5 T) Axle Load stipulated by GE: 0014
10.	Ballast Cushion a) Main Line b) Loop Line and sidings	350 millimeters 250 millimeters
11.	Bridges	32.5 T Axle Load DFC Loading

1.3.6 Operations Control Center Facilities

- 1) A Centralized Operations Control Centre (OCC) for entire Eastern Dedicated Freight Corridor shall be located at Allahabad at Regional Office of Eastern Dedicated Freight Corridor. The OCC shall house the 'Train Management System' and 'Traction Power SCADA Control' for EDFC. All the controllers such as Traffic Controllers, Track Controller, Traction Power Controllers, and Signal Fault Controller etc. shall monitor and manage all train operations and associated activities, including maintenance of entire EDFC from the OCC.
- 2) A Backup Control Centre (BCC) will be provided at DFCC Corporate Office at Noida to take over controls in case of exigencies/breakdown as a Disaster Management Plan. This will be common for DFCC Eastern and Western Corridors. The work of BCC is not included in the present scope of work.
- 3) The Service Building for OCC is being constructed under Contract Package 104.

1.4 CONTRACT PACKAGES FOR DADRI-KHURJA SECTION

1.4.1 The work of Dadri-Khurja section has been divided in different packages as under:

Contract Package	Jurisdiction	Description
302	Dadri - Khurja	Civil, Structure and Track works

105	Dadri - Khurja	Signalling, Telecommunication, 2x25 kV AC Traction Electrification, E&M and Associated works
-----	----------------	--

1.4.2 2x25kV AC Electrification, Signalling & Telecommunication, E&M and associated works including Power Supply at Stations and Auto Location Huts as required by tapping both Up and Dn OHEs through Auxiliary Transformers (Aux. AT) with auto change over switch Panel work is covered under contract package CP 105.

1.4.3 Civil, Structure and Track (CST) Contract Package (CP-302) are planned to commence about a year ahead of Systems Work Contract Package (CP-105). Completion dates for the CST, Signalling & Telecommunication and Electrical works have been planned to be the same so as to facilitate integrated testing and commissioning of the entire section.

1.5 CONTRACT PACKAGES FOR ADJACENT SECTION

Contract Package	Jurisdiction	Description
303	Khurja – Pilkhani	Civil, Structure and Track works
305	Khurja – Pilkhani	Signalling, Telecommunication, 2x25 kV AC Traction Electrification, E&M and Associated works
CTP 14	Dadri - Rewari	Civil, Building and Track Work, Electrical & Mechanical Works and Signaling & Telecom Works.
104	Bhaupur - Khurja	Signalling, Telecommunication, 2x25 kV AC Traction Electrification, E&M and Associated works

1.6 SCOPE OF WORK

1.6.1 The Scope of work is comprised of Design, Manufacture, Procure/Supply, Construct/Install, Build, Testing and Commissioning of 2x25kV AC Electrification, Signalling & Telecommunication, E&M and associated works, as required for safe and reliable operation for Dadri - Khurja section of Eastern Corridor.

1.6.2 The Work shall be executed based on “Employer’s Requirements” as detailed in this “General Specifications” and the “Particular Specifications” as specified below and other documents included in this Bid:

a. Volume-1: General Specifications,

It describes the Employer’s General Requirement for execution of the 2x25kV AC Electrification, Signalling & Telecommunication, E&M and associated works, for Dadri – Khurja section of Eastern Corridor of DFCC.

b. Volume-2: Particular Specifications-2x25kV, AC, Traction Electrification and associated Works,

It describes the Employer’s Requirement and the scope of work for execution of 2x25 kV, AC, Traction Electrification and associated works for Dadri – Khurja section of Eastern Corridor of DFCC.

c. Volume-3: Particular Specifications- Signalling Work

It describes the Employer's Requirement and the scope of work for execution of Signalling Work, including Train Management System works for Dadri – Khurja section of Eastern Corridor of DFCC.

d. Volume-4: Particular Specifications- Telecommunication Works,

It describes the Employer's Requirement and the scope of work for execution of Telecommunication System Works for Dadri - Khurja section of Eastern Corridor of DFCC.

e. Volume-5 : Particular Specifications-E&M and Associated Works,

It describes the Employer's Requirement and the scope of work for execution of E&M, Service Buildings and Associated Works for Dadri – Khurja section of Eastern Corridor of DFCC.

1.6.3 Permanent Works

All works required for Electrification (2x25 kV), E&M, Signalling & Telecommunications for Dadri –Khurja sections as per the details identified in Volume 1 to 5 of this document except temporary works required for facilitation and delivery.

1.6.4 Temporary Works

- a) The Contractor shall execute all Temporary Works required to facilitate construction/Installation of permanent works.
- b) All temporary arrangements and Works shall be designed and necessary drawings developed to ensure that these remain safe during construction/Installation.
- c) As a rule, temporary Works shall be subsequently dismantled and removed by the Contractor after construction/installation, at his own cost. The Engineer, however, may permit retention of some of the temporary works with mutual consent between the Contractor and the Engineer.

(End of Chapter-1)

CHAPTER-2: GENERAL

2.1 DEFINITIONS AND INTERPRETATIONS

In addition to the words and expressions defined in the Conditions of Contract, following words and expressions shall have the meaning assigned to them except where the context otherwise requires:

- (1) **“As-Built Documents”** means those drawings & documents produced by the Contractor and endorsed by it as true records of construction/Installation of the Permanent Works and which have been agreed with the Engineer.
- (2) **“Availability”** The probability that an item will be in a state to perform a required function under given conditions at a given instant of time or over a given time interval assuming that the required external resources are provided.
- (3) **“Apportionment”** process whereby the RAMS elements for a systems are sub-divided between the various items which comprise the system to provide individual targets.
- (4) **“Assessment”** undertaking of an investigation in order to arrive at a judgment, based on evidence, of the suitability of a product.
- (5) **“Combined Services Drawings”** means drawings showing the services details of all the Utilities in a combined drawing indicating locations, layouts and sizes of all electrical and mechanical services.
- (6) **“Compliance”** demonstration that a characteristic or property of a product satisfies the stated requirements.
- (7) **“Commencement Date”** means the date of as defined in Particular Conditions of Contract.
- (8) **“Construction/ Installation Drawings”** shall be derived directly from the Detailed Design and shall detail and illustrate in full the Permanent & Temporary Works. These drawings /documents are the ones which the Contractor considers sufficient in detail for construction/Installation and is cleared by the Engineer for construction/Installation.
- (9) **“Control Terminal”** An Industrial grade computer completes with hard disc, VDU display monitor, key board and mouse, as required.
- (10) **“Corrective Maintenance”** means maintenance performed to correct the occurrence of an equipment or system fault.
- (11) **“Defect”** is any part of the Work which is not in accordance with the Contract.
- (12) **“Detailed Design”** prepared and accepted part of drawings, documents, standards and instructions which is the authorization for manufacture, Procure/supply, construction/Installation and testing. "Detailed Design" has the meaning identified in Chapter-6 of this GS.
- (13) **“Detailed Design Submission”** means the submission of Contractor's Documents which comprise the whole or part(s) of the proposed Detailed Design and for which the Contractor seeks a Notice.
- (14) **“Design Criteria”** means the governing specifications and conditions as specified in Employer's Requirements as detailed in GS and PS.

- (15) **“Design Data”** means all survey and investigations, specifications, plans, drawings, details, graphs, sketches, models, levels, setting-out dimensions, calculations and other documents related to the design of the Works.
- (16) **“Design Manual”** means the manual to be prepared and submitted by the Contractor as part of the Preliminary Design and as described in Chapter-6 of this GS of the Bidding Documents as applicable.
- (17) **“Design Phase”** has the meaning identified in Chapter-6 of This GS.
- (18) **“Designer”** means the Contractor or part of the group forming the Contractor, person, firm or company or group of companies or any replacement carrying out the Design of Works or part thereof.
- (19) **“Drawings”** means the Employer's Indicative Drawings and the Drawings submitted by the Contractor and modification of such drawings, if any, furnished from time to time or for which the Engineer has issued a Notice of No Objection.
- (20) **“Employer”** means the DFCCIL or the person named as Employer and the legal successors in title to this person.
- (21) **“Employer's Personnel”** means the person so authorized for the purpose of Contract Execution.
- (22) The **“Engineer”** means the PMC Representative / the person appointed by the Employer to act as the Engineer for the purposes of the Contract or other person appointed from time to time by the Employer and notified to the Contractor.
- (23) **“Factory Acceptance Tests”** all Type/Routine/ acceptance/special Tests as specified in relevant standards & specifications as needed before dispatch of material and conducted at the premises of Original Equipment Manufacturer.
- (24) **“Failure Mode”** predicted or observed results of failure cause on a stated item in relation to the operating conditions at the time of the failure.
- (25) **“Fault Tree Analysis”** analysis to determine which fault modes of the product, sub-products or external events, or combinations thereof, may result in a stated fault mode of the product, presented in the form of a fault tree.
- (26) **“Hazard”** physical situation with a potential for human injury and / or damage to environment.
- (27) **“Hazard Log”** Document in which all safety management activities, hazards identified, decisions made and solutions adopted are recorded or referenced. Also known as a “Safety Log”.
- (28) **“Interfacing Contractor”** means the Contractor engaged by the Employer or other agencies having an interface issue with the Contractor for this Work.
- (29) **“Interfacing Parties”** comprises the designated contractors/ consultants/ service providers. Other Contractors who are engaged in part of the works and relevant statutory authorities, relevant public utility agency and adjacent contractors who are or will be working adjacent to the site.
- (30) **“Interface Manager”** Is the official appointed by the contractor, directly Responsible to identify, assess the interface requirement with other systems and incorporate in the Detailed Interface Designs to identify the boundaries of responsibilities, get it agreed with interfaced parties and manage the interface requirement within its agreed scope.

- (31) **“Level Crossing”** Is the rail – road surface crossing.
- (32) **“Maintainability”** A characteristic of design and installation, expressed as the probability that an item will be retained in or restored to a specified condition within a given period of time, when the maintenance is performed in accordance with prescribed procedures and resources.
- (33) **“Man Machine Interface (MMI)”** means the visual interface between the Controller and the control system. The MMI consists of the computer screen, displayed objects, icons, and equipment as well as the facilities by which the Controller executes control.
- (34) **“Mean Time to Restore (MTTR)”** means the average time to restore equipment, subsystems, system to full functionally.
- (35) **“Milestone”** means as defined in Particular Conditions of Contract in Part 3 of Bid Document.
- (36) **“Notice”** means a Notice of No Objection.
- (37) **“Other Contractor”** means Contractor(s) other than that for this package i.e. CP-105
- (38) **“Particular Specification”** means the Specifications prepared for the purpose as enclosed in Part – 2, Section VI, Volume 2, 3, 4 and 5.
- (39) **“Permanent Work”** means the permanent works to be designed and executed by the Contractor under the scope of work covered in this GS and relevant PS.
- (40) **“Plan”** means a scheme or method or procedure statement/ document of doing/ proceeding/ making developing in advanced to achieve a desired goal/ objective within a specific time frame.
- (41) **“Preliminary Design”** means the submission of Contractor's Documents which comprise the initial stage of the design phase. It is a basically a concept scheme design.
- (42) **“Preventive Maintenance”** maintenance carried out at predetermined intervals or according to prescribed criteria and intended to reduce the probability of failure or the degradation of the functioning of an item.
- (43) **“Program”** means a time schedule or Programme which has been developed for delivery of a particular purpose or any activity in a time a frame. It is same as “Program”.
- (44) **“Possession”** means taking a section of the IR line(s) out of service. .
- (45) **“Railway”** means Railway or any portion of a Railway for public carriage of passengers and goods including dedicated freight corridors.
- (46) **“Railway Envelope”** means the zone or zones which contain the track, platforms and equipment necessary for the operation of the railway by the DFCC.
- (47) **“Reference Drawings”** means the drawings prepared by the Employer and included in the bidding document.
- (48) **“Reliability”** The probability that an item/equipment/system can perform a required function under given conditions for a given time interval.
- (49) **“Reliability growth”** means a condition characterized by a progressive improvement of a reliability performance measure of an item with time.

- (50) **“Repair”** that part of a corrective maintenance in which manual actions are performed on the item.
- (51) **“Restoration”** that event when the item regains the ability to perform a required function after a fault.
- (52) **“Right of Way”** means the width/area of the land acquired/being acquired for the operation of the railway. Right of way for Phase - 3 of the DFC project has been indicated in Part 4, Reference Documents.
- (53) **“Risk”** probable rate of occurrence of a hazard causing harm and the degree of severity of the harm.
- (54) **“Running Lines”** The DFCCIL running lines between Khurja to Dadri,
- (55) **“Safety”** Freedom from unacceptable risk.
- (56) **“Safety Case”** documented demonstration that the product complies with the specified safety requirements.
- (57) **“Safety-Critical”** means failure of the system, sub-system or equipment that directly leads to a situation with the potential to cause harm, injury to humans,, damage to property, plant or equipment, damage to the environment, or economic loss.
- (58) **“Safety Procedures”** these shall be the procedures as detailed in Chapter-9: “Site Safety Plan” of this GS.
- (59) **“Site”** means the area where the Permanent Works are executed in the Right of Way or adjoining the Right of Way.
- (60) **“Stations”** means Railway stations belonging to IR or DFC. .
- (61) **“System Acceptance Tests”** means those tests that demonstrate the performance of the installation / equipment to the specified requirements as detailed in the Particular Specifications.
- (62) **“System Contractor”** means the Contractor engaged by the Employer to carry out Works related to Systems part of the project.
- (63) **“System Works”** means the works to be carried out by the contractor(s) engaged by the Employer to carry out Works related to ‘Design, Construct/Install, Manufacture, Procure/Supply, Build, Testing and Commissioning of 2x25kV AC Electrification, Signalling & Telecommunication, E&M and associated woks’ as part of the project
- (64) **“Technical Specifications”** means the combined specifications prepared by the Contractor in a format which combines the Technical Specifications and those parts of the Contractor's Technical Proposals which specify standards for design, procurement, manufacture, Procure/supply construction/Installation, testing and commissioning which are developed during the Design Phase and fully comply with the Employer's requirements.
- (65) **“Temporary works”** means all Temporary Works of every kind (other than Contractor's Equipment) required on Site for the execution and completion of the Permanent Works and the remedying of any defects.
- (66) **“Validation”** means confirmation by examination and provision of objective evidence that the particular requirements for a specific intended use have been

fulfilled.

- (67) **“Verification”** confirmation by examination and provision of objective evidence that the specified requirements have been fulfilled.
- (68) **“Video wall”** Graphical representations of 2x25 kV AC Traction Electrification, E&M System and their global operating status.
- (69) **“Works”** means the work, both permanent and temporary or services to be carried out, survey and investigation, designed, manufactured, fabricated, delivered to Site, erected, installed, completed, tested, commissioned, (including Integrated Testing and Commissioning) or supplied in accordance with the Contract and include Plant, Equipment and Material and their accessories.
- (70) **“Working Drawings”** comprise the Construction reference drawings such as construction/Installation drawings, manufacturing drawings and testing and commissioning documents, as are necessary to amplify the Good for construction/Installation Drawings for construction/Installation etc. purposes and endorsed, as required by the Engineer.
- (71) **“Works Program”** means the Program showing list of activities as per the sequence, Duration, start date, finish date, float/ cushion if any, method and timing of Verification/Investigations, design stages, submission date, Date for issue of No Objection Notices, execution (start/ finish), Procurement, manufacture, FAT, delivery to site, access hand over date, Development of Mockup, erection, installation, RAMS demonstration, testing, commissioning of the Works (including Integrated Testing and Commissioning), indigenization (where applicable) and related activities in the form and content prescribed by the Employer's Requirements, or any amended or varied version thereof, as submitted by the Contractor and for which the Engineer has issued a Notice of No Objection.

2.2 ABBREVIATIONS AND ACRONYMS

Abbreviation	Description
AC	Alternating Current
ACTM	AC Traction Manual
Aux AT	Auxiliary Transformers
AT	Auto Transformer
ALARP	As Low as Reasonably Practicable
BIS	Bureau of Indian Standards
CAD	Computer Aided Design
CP	Contract Package
CPCB	Centre Pollution Control Board
CPM	Critical Path Method
CRS	Commissioner for Railway Safety
CSD	Combined Service Drawings
CST	Civil, Structure and Track
CV	Curriculum-Vitae

dB	Decibel
DCN	Design Change Notice
DFC	Dedicated Freight Corridor
DFCC	Dedicated Freight Corridor Corporation
DFCCIL	Dedicated Freight Corridor Corporation of India Limited
DNP	Defect Notification Period
DVV	Design Verification and Validation
E & M	Electrical and Mechanical
EDFC	Eastern Dedicated Freight Corridor
EIG	Electrical Inspector to the Government of India
EI	Electronic Interlocking
EMC	Electro Magnetic Compatibility
EMI	Electro Magnetic Interference
EMP	Environmental Management Plan
EN	Euro Norm
ERP	Enterprise Resource Planning
FAT	Factory Acceptance Test
FCN	Field Change Notice
FMEA	Fault Mode and Effects Analysis
FMECA	Failure Modes Effect and Criticality Analysis
FTA	Fault Tree Analysis
GE	Geotechnical Engineering
GAD	General Arrangement Drawing
GS	General Specification
HT	High Tension
HTML	Hyper Text Markup Language
Hz	Hertz
ID	Identification
ICD	Interface Co-ordination Document
IEC	International Electro – technical Commission
IHA	Interface Hazard Analysis
IMD	Integrated Maintenance Depot
IMSD	Integrated Maintenance Sub Depot
IMP	Interface Management Plan
IR	Indian Railway
IS	Indian Standard
ISO	International Standards Organization

IT	Information Technology
Km / KM	Kilo Meter
KV	Kilo Volt
LT	Low Tension
LC	Level Crossing
LRU	Line Replaceable Unit
MCIL	Maintainability Critical Items List
MDF	Main Distribution Frame
MTBSAF	Mean Time Between Service Affecting Failure
MMI	Man Machine Interface
MTBF	Mean Time Between Failure
MTTR	Mean Time To Repair
MTTR	Mean Time To Restore
NMCP	Noise Monitoring and Control Plan
NOC	No Objection Certificate
O & M	Operation and Maintenance
O&SHA	Operating and Support Hazard Analysis
OCC	Operations Control Centre
ODBC	Open Data Base Connectivity
OEM	Original Equipment Manufacturer
OFC	Optic Fiber Cable
OHE	Over Head Equipment
PHA	Preliminary Hazard Analysis
PMIS	Project Management Information System
PS	Particular Specifications
PVC	Poly Vinyl Chloride
QA	Quality Assurance
RAM	Reliability, Availability & Maintainability
RAMS	Reliability, Availability, Maintainability and Safety
RAP	Resettlement Action Plan
RCIL	Reliability Critical Item List
RDSO	Research Design and Standards Organization
RDT	Reliability Demonstration Testing
ROW	Right Of Way
SAT	System Acceptance Test
SCADA	Supervisory Control And Data Acquisition
SHE	Safety, Health and Environment

SM	Station Master
SOD	Schedule of Dimensions
SOGP	Schedule of Guaranteed Performance
SPM	Suspended Particulate Matter
SRS	System Requirement Specification
SSHA	Subsystem Hazard Analysis
S & T	Signalling & Telecommunication
T&P	Tools & Plants
TOT	Transfer of Technology
TSS	Traction Sub Station
UIC	International Union of Railways
UPS	Uninterruptible Power Supply
VDU	Video Display Unit
VHF	Very High Frequency
WGS	World Geodetic System

2.3 ARCHITECTURE OF BID DOCUMENT: PACKAGE - 105: 2X25 KV AC TRACTION ELECTRIFICATION, SIGNALLING, TELECOMMUNICATION, E&M AND ASSOCIATED WORKS

The architecture of 2x25kV AC Electrification, Signalling & Telecommunication, E&M and associated works Bid Document for Khurja – Dadri section of Eastern Dedicated Freight Corridor is shown below:

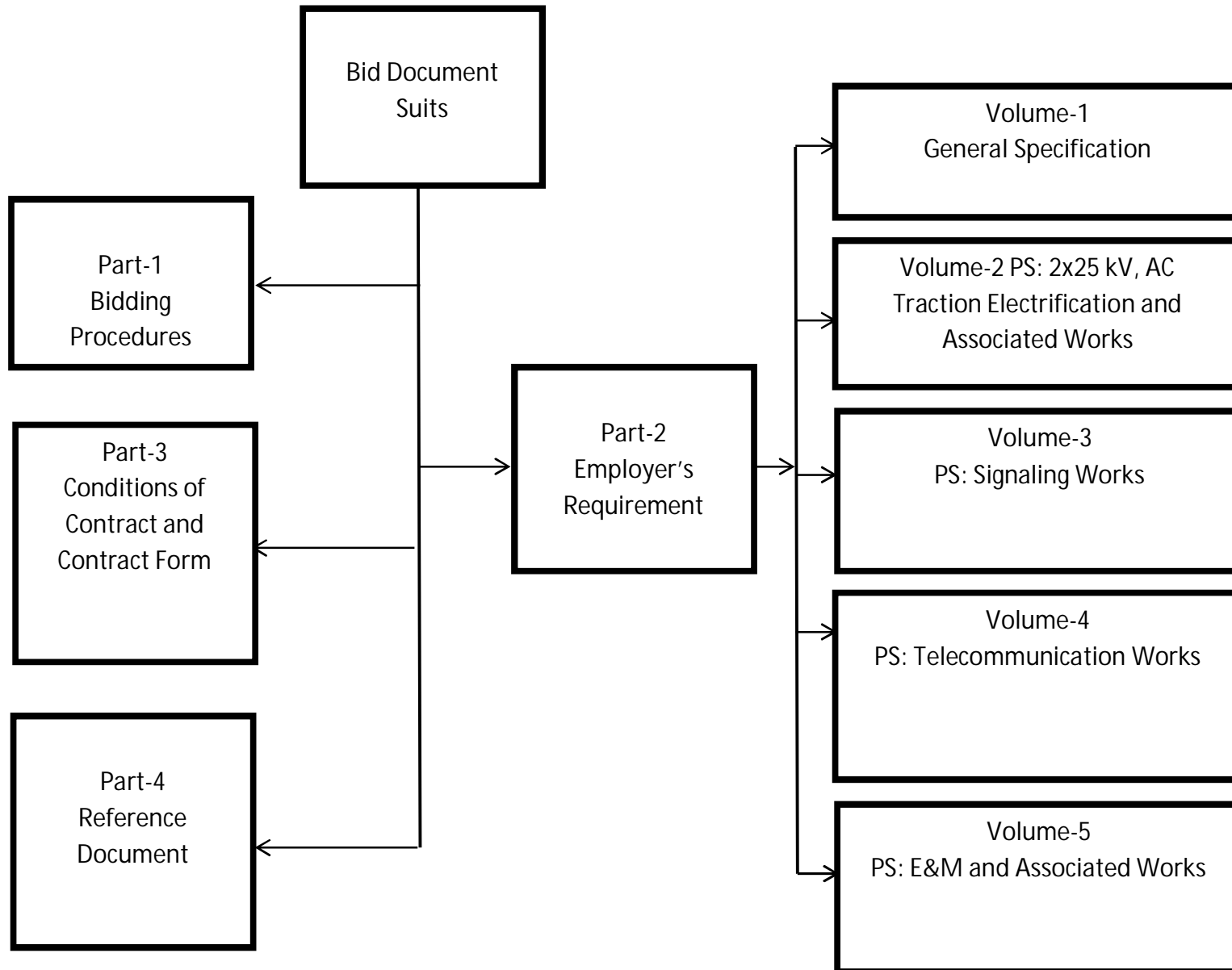

2.4 APPLICABILITY OF GENERAL SPECIFICATIONS AND RELEVANT DOCUMENTS

- 2.4.1 The provisions contained in the Particular Specification (PS) shall prevail over the provisions contained in this GS.
- 2.4.2 These documents shall be read in conjunction with the Conditions of Contract (General and Particular), Employer's Requirement and any other document forming part of the Contract.
- 2.4.3 This design-build contract shall be fulfilled, managed and commissioned in accordance with the applicable legislation in India, specific IR regulations/ International/ National standards as specified.

2.5 REFERENCE DOCUMENTS

Reference Documents as relevant for the package are identified in Part-4.

2.6 CODES & STANDARDS

- 2.6.1 Equipment, materials and systems shall be designed, manufactured and tested in accordance with the latest issue of approved and recognized codes and standards defined and proposed by the Contractor and approved for the Work. All standards, codes and manuals with correction slips issued up to 28 days prior to last date of second stage of Bid submission shall be applicable for this bid. Any other applicable code, circular, instruction of UIC shall be referred with the approval of the Engineer.
- 2.6.2 References to "standards or to materials and equipment of a particular manufacturer" in these contract documents shall be regarded as followed by the words "or equivalent".
- 2.6.3 The Contractor shall supply to the Engineer, two authorized and original full editions of the publications (such as, but not limited to, Technical Standards and Codes of Practice), the codes and standards proposed /used for carrying out the Designs, Contractor's Documents, the Drawings and other communications relevant to this Contract.
- 2.6.4 These publications shall be for the sole use of the Engineer and Employer and, upon completion of the Contract, shall become the property of the Employer.
- 2.6.5 The Contractor shall ensure that items of equipment and their components are standardized wherever possible throughout the Works where similar requirements and functions exist.
- 2.6.6 The Contractor shall propose for the review without objection of the Engineer in its design submissions the standards it proposes to use which shall include those quoted in the Employer's Requirements. The Contractor may propose an alternative equivalent international standard during the design stage but the acceptance of the alternative standard shall be subject to review by the Engineer.

2.7 SCHEDULE OF DIMENSIONS AND CLEARANCES

- 2.7.1 The Permanent works shall not infringe the Schedule of Dimensions (SOD) of Eastern DFCC and land boundary limits of DFCC as shown on the drawings as listed in Part 4 - Reference Documents.

- 2.7.2 In addition, the Contractor shall formulate all necessary drawings, plans, documents etc. in accordance with the applicable legislation in India, in compliance with the Contractor definitive design for all clearances.

2.8 SPECIFICATIONS

- 2.8.1 The Technical Specifications for the Work shall be in accordance with the requirement detailed in Part – 2, Section VI: General Specifications & Particular Specifications Volume 1 to Volume 5.
- 2.8.2 In accordance with the provisions of these documents, the Contractor shall develop the System Requirement Specifications (SRS) during the Design stage and submit along with the Inception Report. The SRS compliance shall be submitted as part of the Detailed Design Submission along with the Schedule of Guaranteed Performance (SOGP) proposed by the vendor of the equipment selected and as desired & approved by the Engineer.
- 2.8.3 When the Specifications have received a 'Notice of No Objection' from the Engineer, these shall become the Technical Specifications.

2.9 LANGUAGE OF CONTRACTOR'S DOCUMENTS

All documents, reports, drawings, calculations and correspondence and the like shall be submitted by the Contractor in English.

2.10 PROJECT MANAGEMENT INFORMATION SYSTEM (PMIS)

- 2.10.1 The Contractor shall utilize a Proven PMIS such that all documents generated by the Contractor can be transmitted to the Engineer through electronic means and traceable.
- 2.10.2 The PMIS shall also allow all documents generated by either party to be electronically captured at the point of origin and be reproduced later, electronically and in hard copy.
- 2.10.3 The requirements of PMIS are explained in Chapter 15, Appendix-7- "PMIS Requirement and Procedures".

2.11 PATENT, COPYRIGHT OR OTHER INTELLECTUAL PROPERTY RIGHTS

The patent, copyright or other intellectual property rights in any Plant, Design Data, plans, calculations, drawings, documents, material, know-how and information relating to the Works shall be vested with the Contractor. The Contractor shall grant to the Employer, his successors and assignees, a royalty-free, nonexclusive and irrevocable license to use and reproduce any of the Works, Designs or inventions incorporated and referred to in such plant, documents or material and any such know-how and information for all purposes relating to the Works, including without limitation, the design, manufacture, installation, reconstruction, testing, commissioning, completion, reinstatement, extension, repair and operation of the Works.

Infringement of Patent Rights

The Employer shall not be responsible for infringement of patent rights arising due to similarity in design, manufacturing process, use of similar components in the design and development of any system/sub system(s) or due to any other factor not mentioned

herein which may cause a dispute. The entire responsibility to settle any such disputes / matters shall lie with the Contractor.

2.12 PUBLICITY

The Contractor / Sub-Contractor(s) shall not publish, present seminars, forums or otherwise circulate, alone or in conjunction with any other person, any article, photograph or other material relating to the Contract, the Site, the Works, the Project or any part thereof, nor part with the Press, or any radio or television network, any information relating thereto, nor allow any representative of the media access to the Site, Contractor's Works Areas, or off-Site place of manufacture, or storage except with the permission, in writing, of the Employer. The provisions of this Sub-Clause shall not exempt the Contractor from complying with any statutory provision in regard to the taking and publication of photographs.

2.13 GUARANTY/WARRANTY CERTIFICATES OF OEM

All Original Guaranty/Warranty Certificates of OEMs should be registered in the name of DFCCIL. These Guaranty/warranty certificates received from the OEMs should be passed on to DFCCIL.

2.14 SURVEY AND SITE INVESTIGATIONS

The Contractor shall carry out all necessary surveys and all further site investigations as required for the design of the system works and to enable the determination of the methods of construction / Installation and the nature, extent and design of the Temporary Works.

The Contractor shall not use materials from the sources (including that of Railways) within the Right of way of DFC / Indian Railway boundaries. This could be materials for earthworks, aggregate for concrete manufacture, stone for ballast etc. and it is their responsibility to obtain all necessary permissions, approvals etc. from landowners; Local, State or Central government authorities for the extraction, reconstitution and transportation of such materials to the relevant worksite.

2.15 ALIGNMENT & YARD PLANS ETC

2.15.1 The alignment plans, yard plans, building plans and power supply schemes and SCADA layouts listed in Bid Document Part 4 - Reference Documents are for reference purpose only.

2.15.2 The Contractor shall review, verify and revalidate all relevant factors which could have an impact on the Design and construction / Installation of 2X25 kV, 50 Hz, AC, Traction Electrification, E&M and associated works including but not limited to the topography, subsurface conditions, ground water levels, Temporary Works, dewatering, drainage, climatic conditions, the availability or lack of access, working space, storage, accommodation, restrictions imposed by the existing Indian Railways Tracks, the proximity of adjoining structures and roads, the local regulations regarding the obstruction of public highways and any other limitations imposed by the site and its surroundings, for the satisfactory completion of Works meeting with performance requirements in the stipulated time.

2.15.3 It will be presumed that Contractor has verified and taken note of all effects of these constraints in his Design, construction/Installation operations to ensure on-time completion of the Works.

2.15.4 No claim by the Contractor on the grounds of lack of foresight or knowledge of the site conditions or any unknown parameters shall be considered.

2.16 UNITS OF MEASUREMENT

The Contract shall utilize the SI system of units.

2.17 CLIMATIC CONDITIONS

2.17.1 General

(1) The project length, from Khurja – Dadri section falls along the Tropic of Cancer. The average, highest and lowest temperatures as witnessed at Khurja. The design should consider the lowest and highest temperatures witnessed in the section.

- a. During the summer months the temperature as high as 48°C temperatures has been recorded at Khurja on the Khurja - Dadri section with a high level of humidity.
- b. During the winter months the temperatures lowest of (-) 3°C during night has been recorded at Khurja on the Khurja – Dadri section.
- c. Torrential rains and high humidity accompany the monsoon are in late June to early September.
- d. The Contractor's design should meet the requirement of the highest ambient temperature of 50°C and lowest ambient temperature of (-) 5°C.

2.17.2 The values of the parameters regarding temperature are indicative only. Notwithstanding the stipulation as above, the contractor shall collect climatic data in respect of minimum & maximum temperatures, rain, flood levels, relative humidity, sun shine and wind velocity/pressure etc. from "India Meteorological Department publications" or other Civic Bodies and shall consider for designing any part/ component of the Permanent Works and in case the ambient temperature is beyond the range of 50°C and (-5°C), the Contractor shall ensure that due allowance is made for severe most local conditions in which Permanent Works are required to operate, for example, with restricted ventilation that may lead to higher local ambient temperatures, and any other factors that may affect the operating environment in any way.

2.17.3 The Contractor's attention is drawn to the more severe environmental conditions that may exist during the construction/ Installation period. The contractor shall take adequate measures to protect the Permanent Works against any deleterious effects of such conditions during the time between installation and final completion of the Project. The Contractor shall be deemed to have taken into account all weather conditions arising from any cause whatsoever, including river flooding, excessive rainfall, salinity, temperature, humidity, high winds, lightning, or any other weather conditions as per IS 13736 (all parts) and as per the application duty requirement.

2.17.4 Without limiting its liabilities under the Contract, the Contractor shall take all necessary precautions to protect the Works and Contractor's Equipment against the effects of weather, provided however Contractor shall inform the Engineer in such circumstances which lead to stoppage of works.

2.17.5 The Contractor shall be responsible for obtaining and acting upon all relevant weather information and no work shall be performed when such work is liable to be injuriously affected by weather conditions.

2.17.6 Air throughout the Project will contain considerable moisture content. The Permanent Works shall be tropicalized and vermin proof.

Classification of Equipment Environment

- (1) Table below gives the different classifications of equipment environment to be encountered. The locations at which equipment may be installed have been divided into five environmental classes as mentioned below.

CLASS	LOCATION of EQUIPMENT
A	Air Conditioned Offices and Equipment Rooms. Air-conditioning failure of less than 2 hours duration at a time is permissible.
B1	Equipment Rooms with air-conditioning with possibility of failure of air-conditioning for a duration of 2 hours or more at a time.
B2	Equipment Rooms without air-conditioning where adequate ventilation may or may not be available.
C	Buried underground or installed in manholes.
D	Outdoors – Cabinets or Containers protected from direct sunlight without any ventilation.

- (2) All equipment shall be designed and tested in accordance with the given figures allowing a margin of at least 10% greater and 2°C less than the limits recorded. All designs for equipment shall work within the enclosures proposed with the specified environment outside the enclosure. The following are the minimum design requirements for equipment to be installed in each class of environment. Where any class does not have a value for a parameter, the most extreme value quoted for the lesser class environments should be used. For any equipment that is proposed to be installed in more than one environmental clause, the design shall take into account the most severe environmental class conditions.

(a) Requirements for Class A	
Minimum Temperature	5°C
Ambient Temperature	29°C
Maximum Temperature	35°C
Relative Humidity	Minimum 0%, Nominal 65%, Maximum 95% (Non Condensing)
Electrical Noise	< 1MHz. 1kV damped to 50% after 6 cycles. Radio Frequency field strength 10 V/m, VHF band.

(b) Requirements for Class B	
Minimum Temperature	-2.5°C (B1) and (B2)
Ambient Temperature	30°C (B1) and 50°C (B2)
Maximum Temperature	45°C (B1) and 55°C (B2)
Relative Humidity	Nominal 70%, Maximum 100% (Non condensing)

Air Quality	Polluted and dusty - SO ₂ :80-120mg/m ³ Suspended Particulate Matter: 360-540mg/m ³
Electrical Noise	Impulse 1kV, 1.2/50 rise/decay, 500Σ source impedance, 0.5J source energy.
Radio & High Frequency	as Class A.

(c) Requirements for Class C	
Minimum Temperature	-2.5°C
Ambient Temperature	46°C
Maximum Temperature	60°C
Relative Humidity	Nominal 70%, Maximum 100% (Non condensing)
Electrical Noise	Impulse 5kV, otherwise as Class B

(d) Requirements for Class D		
Guaranteed Range	Temperature	0°C to 55°C
Operational Range	Temperature	-5°C to 60°C

(End of Chapter-2)

CHAPTER-3: PROJECT PLANNING & MANAGEMENT

3.1 GENERAL

3.1.1 In order to ensure compliance with the Requirement of Contract and satisfactory Programed execution of the works within specified targets, and quality in design, manufacturing and execution of work, a series of Management Plans shall be developed.

3.1.2 The Plans and Documents shall be coordinated with each other and shall collectively define, describe and encompass the Contractor's proposed methods, procedures, processes, organization, sequencing of activities, etc. and shall show how these combine together to assure that the Works truly meet the requirements of the Specification in respect of the mentioned subjects.

3.1.3 Unless otherwise stated in the PS, all plans and documents shall be submitted as detailed below :

- (1) As required in accordance with the Works Program;
- (2) Whenever the development of the Contractor's designs or planning allows the plan to be developed further;
- (3) In response to comments made by the Employer's Personnel/Engineer
- (4) Whenever any change occurs that invalidates the information contained in the previously submitted and reviewed document, within 28 days of the occurrence of such change; and
- (5) As requested by the Engineer from time to time

3.1.4 The following Management Plans shall be developed and submitted by the Contractor for the Engineer's review.

Sr.	Management Plan/ Submission	Submission
1	Project Management Plan	42 days
2	Project Organization Plan	28 days
3	Document Management Plan	28 days
4	Design Management Plan	28 days
5	Design Submission Plan	28 days
6	Simulation Study Plan	56 days
7	Interface Management Plan	42 days
8	Project Quality Assurance Plan	56 days
9	Reliability, Availability, Maintainability and Safety (RAMS) Plan.	90 days
10	EMC/EMI Management Plan	42 days
11	Software Quality and Assurance Plan	42 days
12	Fire Safety Plan	42 days
13	Verifications, Validation and Demonstration Plan	90 days
14	Procurement Management & Manufacturing Plan	56 days
15	Factory Acceptance Test Plan	180 days
16	Co-ordinated Installation Plan	90 days
17	Site Management Plan	42 days
18	Site Safety Plan	56 days

19	Health & Environment Plan	56 days
20	Testing & Commissioning Management Plan including Trials and Integrated testing & commissioning	180 days
21	Permits and Approvals plan	90 days prior to date of Taking over of Completed works
22	Training Plan and Transfer of Technology Plan	
	(1) Training Plan	180 days
	(2) Transfer of Technology Plan	180 days
23	Operation & Maintenance Plan	180 days Prior to date of Taking over of Completed works.
24	Spares Management Plan	180 days Prior to date of Taking over of Completed works.
25	Defect Liability Management Plan	180 days Prior to date of Taking over of Completed works.

- 3.1.5 The Contractor shall submit the above management Plans within number of days of the commencement date / as specified above. These plans shall be further developed / modified / magnified in accordance with the procedure described in this General Specification during the course of the Project as required. These plans shall be subject to review of the Engineer.
- 3.1.6 The respective Plans shall be submitted which shall have received 'No Objection' from Engineer who shall have the right to request the Contractor to make amendments as deemed necessary.

3.2 PROJECT MANAGEMENT PLAN

- 3.2.1 The overall management of the Works shall be the Contractor's responsibility. The organization of the resources for the design, procurement, manufacture, delivery, installation, testing and commissioning, and setting to work is to be clearly defined & developed into a Project Management Plan. Each section of this plan shall fully describe the Contractor's understanding of the Works and management skills and structure required to achieve the same.
- 3.2.2 The Contractor's Project Plan shall provide a clear overview of the Contractor's organization, management systems and methods to be used for complete execution of the Works.
- 3.2.3 The Contractor's Project Plan shall include a summary description of each and every stage of implementation of the Works, clearly showing the principal organizational interfaces both within the Contractor's own organization (including sub-contractors of every tier) and with Other Contractors and Relevant Authorities, defining how each of these interfaces is to be managed and controlled. An organization chart shall be produced to illustrate the subdivision of the work into elements for effective technical and managerial control, the reporting structure and the interface relationship among all

parties involved. Names, addresses, telephone and fax numbers of all principle contacts shall be listed.

- 3.2.4 The Contractor's Project Plan shall contain structured organization charts showing the hierarchical relationship of the Contractor's organization (including sub-contractors of every tier). The organization charts shall be produced as a "family" such that the basic chart shows the overall organisation structure supported by subsidiary charts detailing the internal structure of various departments or sections of the overall organisation.
- 3.2.5 The Contractor's Project Plan shall include full details of the qualifications, experience, authority and responsibility of the personnel assigned to all key positions of the Contractor's organisation (including sub-contractors of every tier). As a minimum, this shall include all levels down to senior managers and shall include the personnel responsible for each individual department and functional group. A clear reference shall be given as to the location of staff (e.g. site resident or factory based, etc.). Names, addresses, telephone and fax numbers of all principle contacts shall be listed.
- 3.2.6 The Contractor's Project management Plan shall define the Contractor's management structure for the execution of the Works and for the control of the quality of the Works and shall, without limitation, identify and set out:
- (1) The procedure for audit;
 - (2) The procedures for the control of receipt and issue of all Works related correspondence so as to ensure traceability;
 - (3) The procedures for filing system to be implemented to maintain the Contractor's records during the course of the work. The filing systems used by the Contractor and sub-contractors of any tier shall be compatible;
 - (4) The procedures for the identification, production, verification, internal approval, review (when required) by the Engineer, distribution, implementation and recording of changes to all drawings, reports and specifications;
 - (5) The procedures for the evaluation, selection, engagement and monitoring of sub-contractors / suppliers together with the means of application of quality assurance to their work including audit and acceptance;
 - (6) The procedure for the regular review and revision of each type of quality plan and its supplemental individual specific quality plans to ensure their continuing suitability and effectiveness, in addition to the method to be used for revision and issue of revised documentation;
 - (7) The procedures for the control, calibration and maintenance of inspection, testing and measuring equipment;
 - (8) The procedures for the selection, indexing, disposition and maintenance of project records for storage in the archives. A list of items to be archived including their periods of retention shall be submitted for review by the Engineer;
 - (9) The procedures for identifying training needs and for the provision of training of all personnel performing activities affecting quality; and
 - (10) The procedures for the control of non-conformity.
- 3.2.7 The Project Management Plan submitted by the Contractor shall be reviewed by the Engineer, who will have the right to seek amendments as deemed necessary by the Engineer

3.2.8 Contractor's Personnel

- (1) The Contractor shall provide all necessary supervision during the execution of the Works as long as the Engineer considers necessary for the proper fulfilment of the Contractor's obligations under the Contract.
- (2) The Contractor shall ensure that he is at all times represented on the Site by a competent and authorised English/Hindi speaking Personnel who shall be deemed to have been reviewed without objection by the Engineer, in writing within 14 days from the service of a notice upon the Engineer by the Contractor for the appointment of such Personnel. Such Contractor's personnel shall be constantly on the Site and shall give his full time to the superintendence of the Works.
- (3) The Engineer shall have the authority to withdraw his notice of no objection to the Contractor's Personnel at any time. If such notice of no objection is withdrawn, the Contractor shall remove the Contractor's Personnel from the Site forthwith and shall not thereafter employ him again on the Site in any capacity and shall forthwith replace him by another competent English/Hindi speaking Contractor's Personnel as 'reviewed without objection' by the Engineer.
- (4) Such authorised Contractor's Personnel shall receive on behalf of the Contractor directions and instructions from the Engineer.
- (5) The following particulars of the proposed Contractor's Personnel shall be submitted to the Engineer for review:-
 - (i) name;
 - (ii) copy of Identity Card;
 - (iii) details of qualifications, including copies of certificates; and
 - (iv) Details of previous experience.
- (6) The particulars of the Contractor's Personnel shall be submitted 28 days before the agreed 'scheduled start' of that part of the Works, except in the case of a replacement of Contractor's Personnel, in which case, the said particulars shall be submitted forthwith.

3.3 PROJECT ORGANIZATION PLAN

- 3.3.1 The Contractor shall within 28 days from the Commencement Date submit a mobilization Plan for the Engineer's review.
- 3.3.2 The Mobilization Plan shall include but not be limited to Setting up of Design Office, Site office, mobilization of Contractor's Key and support personnel, Procurement of facilities, Information required by the Contractor and deliverables to be submitted.
- 3.3.3 Manpower forecasts shall be prepared in the form of a series of graphic displays based on the Works Program resource-loading. The output shall display the number of man-days of effort, for each month over the life of the Project on both 'early start' and 'late start' basis.
- 3.3.4 Within 7 Days of receiving the LOA of the work, Contractor shall set up the required communication facilities i.e. office Telephone, fax and documentation facility immediately.
- 3.3.5 Within 15 days of receiving the LOA of the work, the Contractor shall issue a communication matrix identifying the Project Director and the other key personnel with

their roles and responsibilities and their communication telephone, mobile, fax and email addresses and shall keep it updated throughout the project.

3.4 DOCUMENT MANAGEMENT PLAN

The contractor shall establish a Document Management System as detailed in Chapter-5: Document Management Requirement of this GS. Document Management Plan shall incorporate the Document Control Procedures such as:

- a. Document Format;
- b. Document numbering system;
- c. Document release / version control;
- d. Obsolete/ superseded Document withdraw system;
- e. Number of copies.

3.5 DESIGN MANAGEMENT PLAN

3.5.1 Design shall be undertaken to ensure a smooth flow of information for review by the Engineer. Submissions shall be strictly in accordance with the Design Submissions Program.

3.5.2 The Contractor shall perform his designs for the Works and prepare a design plan for his design work in accordance with the following design stages. The Contractor shall submit to the Engineer for his review, relevant design information as identified under each stage:

- a. Preliminary Design along with Performance parameters and design verification checklists, design Manual;
- b. Detailed Design;
- c. Construction / Installation Design & drawings;
- d. As Built Documents.

3.5.3 The Contractor shall submit a Design Management Plan detailing the design process and describing:

- a. The "Design Input" for the project;
- b. The organization chart for the design team;
- c. The process for integration of all the systems;
- d. The process for internal design review and "sign-off" of drawings and design documentation (by officials i.e. prepared by, checked by and issued by) prior to submission for review by the Engineer;
- e. The design Submission Program;
- f. The process for design change control.

3.6 DESIGN SUBMISSION PLAN

3.6.1 The objective of the design submission plan is to ensure that the proposed resulting works comply with the Employer's Requirements and the Standards and Specification, are capable of being produced consistently to exacting quality standards, achieve low life

cycle costs and can be operated with high reliability and safety to the satisfaction of the Engineer.

3.6.2 The design submissions include design calculations, design reports and design drawings.

3.6.3 In the event that a statutory body (e.g. Government of India Ministry of Railways, RDSO, Commissioner of Railway Safety, etc.), Independent Engineer, independent RAMS assessor or independent safety assessor requires design information in a particular format or any other additional information, it shall be incumbent upon the Contractor to provide the same, as directed by the Engineer.

3.7 SIMULATION STUDY PLAN

3.7.1 The Contractor shall identify the simulation study requirements as specified in Particular Specification and submit a Simulation Study Plan identifying:

- (1) the Activities and deliverables of simulation study;
- (2) Identification of the proven simulation agency;
- (3) Approval of the Engineer / Employer's Personnel and engagement thereof of the Simulating Agency;
- (4) Submission of Input Data Reports;
- (5) Review of the Input Data Report by the Engineer;
- (6) Incorporation of the observations of the Engineer;
- (7) Producing Simulation and Simulation results for various options;
- (8) Review of The Simulation Results by the Engineer/ Employer's Personnel;
- (9) Incorporation of the observations of Engineer/ Employer's Personnel on Simulation Results;
- (10) Conducting revised Producing Simulation and Simulation results for various options;
- (11) The simulation Results shall conform and validated to Standards EN50119, EN50317, EN50318, EN50329, EN50388, EN50367, EN50641, EN50163, EN50122-1, EN50124-1, EN50121 (all parts), IEEE80:2013, IEC 60909 and other standards as specified in Part – 2 Employer's Requirements.

3.7.2 The simulation study may involve a number of iterations to optimize the Solution.

3.7.3 Simulation study shall suggest a value added optimized solution with reasoning.

3.7.4 The Scope of Simulation Study is included in Particular Specification.

3.8 INTERFACE MANAGEMENT PLAN

3.8.1 The Contractor shall interface and liaise with Other Contractors in accordance with the Employer's Requirements, Chapter-10 – Interface Management of this GS and in relevant chapter of Part – 2, section VI, Volume – 2, 3, 4 & 5: Particular specifications.

3.8.2 The Contractor shall develop and submit to the Engineer, an Interface Management Plan, which is mutually acceptable to both the Contractors and the Other Contractors. The Interface Management Plan shall:

- (1) identify the sub-systems as well as the civil works and facilities with interfacing requirements;
- (2) define the authority and responsibility of the Contractor's and Other Contractors' (and any relevant sub-contractors') staff involved in interface management and development;
- (3) Identify the information to be exchanged, precise division of responsibility between the Contractor and Other Contractors and integrated tests to be performed at each phase of the Contractor's and Other Contractors' works;
- (4) Address the Works Program of the Contract to meet dates of activities of each Contractor and highlight any program risks requiring attention of the Employer.

3.8.3 The Engineer shall review the Contractor's initial Interface Management Plan and shall have the right to require the Contractor to make amendments as deemed necessary by the Engineer. The Contractor shall amend the initial Interface Management Plan based on the comments received from the Engineer and submit the final Interface Management Plan and the Engineer shall issue an Advice of No Objection to such Interface Management Plan.

The Contractor shall be responsible for detailed co-ordination of his design, manufacturing, construction/installation, testing and commissioning activities and will take the lead for System Works in the management of the coordination process with IR, interfacing contractors, utility agencies, statutory authorities, private service providers, consultants and other contractors whether or not specifically mentioned in the contract that may be working on or adjacent to the site for the purpose of the Project.

3.8.4 It is anticipated that System Work Contractor shall be in place within one year after the Commencement Date of CST Works. Contractor shall plan his interfacing requirements accordingly.

3.9 SYSTEM ASSURANCE PLAN

3.9.1 Project Quality Assurance Plan

The Contractor shall submit the Project Quality Assurance Plan for approval of the Engineer as described in Chapter -11 of this GS.

3.9.2 Reliability, Availability, Maintainability & Safety (RAMS) Plan

- (1) The Contractor shall submit a RAMS Plan for approval of the Engineer as described in the RAMS chapter-12 of this GS and relevant chapter in PS.
- (2) The Contractor shall describe procedures required to perform the specific tasks necessary to achieve RAMS requirements in this plan including the RAMS demonstration Plan.

3.9.3 EMC/EMI Management Plan

- (1) The Contractor shall prepare and submit for review by the Engineer, an EMC Plan in accordance with the Employer's Requirements. The Contractor shall describe procedures required to perform the specific tasks necessary to achieve EMC requirements.
- (2) EMC/EMI Management Plan should be based on a top-down approach defining the EMI, EMC philosophy, Assessment & Control activities, means of control during design processes and implementation and EMC submissions to be supplied

to demonstrate compliance with Employer's Requirements: General Specification and Particular Specification. The EMC/EMI Management Plan shall identify a comprehensive list of specifications, standards, method statements and procedures to be submitted to the Engineer for review. The EMC Management Plan shall also include a Program for the dates for EMC submissions.

- (3) The EMC/EMI Management Plan shall include an initial list of design documentation, test specifications and test reports with a single paragraph description of each document to indicate compliance with the Specification.
- (4) The EMC/EMI Management Plan shall include a definition and description of the process and methods used for Verification and Validation that the Works will achieve the required EMC parameters in all respects.
- (5) The Contractor shall assess and control the levels of interference emissions and susceptibility of all equipment which are to be designed, manufactured, supplied and installed by the Contractor and its sub-contractors and suppliers.
- (6) The Contractor shall designate a person as point of contact to deal with EMC matters. Details of the nominated person and any subsequent change of the nominated person shall be subject to review by the Engineer.
- (7) The Contractor shall liaise and co-ordinate with all Other Contractors in the exchange of EMC data and related equipment performance characteristics and advise the Engineer when any such information is requested from any Other Contractor. A copy of all EMC related information exchange shall be sent to the Engineer for review.
- (8) The Contractor shall comply with the following EMC requirements:
 - (a) The Contractor shall ensure that all electrical and electronic apparatus is designed and constructed to operate without degradation of quality, performance or loss of function in the electromagnetic environment of the Project.
 - (b) The Contractor shall meet the requirements of the EN 50121 series of standards (Railway applications – Electromagnetic compatibility), 1996 edition, the UK's Electromagnetic Compatibility Regulation, the IEC 61000: Electromagnetic Compatibility or equivalent and other standards mentioned in the Employer's Requirements-Particular Specification. EMC considerations shall be incorporated in the Contractor's procedures for product safety and design Verification.
 - (c) The design shall ensure that any electromagnetic interference emissions introduced into the environment do not exceed the limits as prescribed in Standards. The Contractor shall ensure that electromagnetic compatibility (EMC) requirements are adequately complied. Any shortcomings shall be made known to the Engineer immediately and recommendations for corrective action formulated.
 - (d) In respect of the design documentation, the Contractor shall demonstrate by theoretical analysis that the design of the electrical and electronic systems is fully compliant with the EMC requirements identified. The Contractor shall state clearly in the documentation all the assumptions made and parameters used in the analysis.
 - (e) The Contractor shall detail the methodology, verify and validate any

simulation models used in support of the analysis. The Contractor shall prepare and submit to the Engineer for review reports of the Verification and Validation of the models.

- (f) The Contractor shall submit documentation/ evidence showing how system safety and reliability is not affected with achieved EMC. It shall include Failure Modes, system failures, and the effect of human intervention and how equipment EMC thresholds have been set in order to keep them above worst case interference levels, and how equipment tolerances and other characteristics in the Specification have been allowed for in designing the system.
- (g) The Engineer may conduct an independent EMC audit for both the system and its component parts and shall therefore require access to all the relevant design and production information. The Contractor shall supply sufficient documentation and analysis in a form reviewed by the Engineer.
- (h) EMC type testing as per standards shall be carried out on all equipment identified in the design stage, which require attention regarding EMC.
- (i) The Employer's Personnel/ the Engineer may request at his discretion, attendance at the manufacturing factory prior to delivery to assist in providing confidence that the EMC requirements will be met. However, this will not give design acceptance that can only be given after successful completion of the System Acceptance Tests.
- (j) The Employer's Personnel/ the Engineer may request that tests be carried out to simulate the Failure Mode of any critical hardware/software component that is considered to have a significantly detrimental effect.
- (k) The Contractor shall implement corrective actions to rectify any EMC problems identified during design, on-Site testing and when the whole system is in operational service.
- (l) The Contractor must be fully aware of the EMC requirements and any modifications to systems and equipment carried out by the Contractor during the Defect Notification Period shall not cause the immunity or emission levels of the installed system and equipment to exceed such values. Detailed EMC documentation on all modifications carried out shall be submitted to the Engineers for review. Modification work shall not commence until the respective submission has been reviewed without objection by the Engineer.

3.9.4 Software Quality And Assurance Plan

Where software is design Deliverable, the Contractor shall submit the Software Quality Assurance Plan for approval of the Engineer as described in RAMS Chapter-12 of this GS. The Software quality Assurance plan shall address all elements of the design and development of the software required as part of the works.

3.10 FIRE SAFETY PLAN

The contractor shall conduct a Risk and hazards study to identify the fire hazards for each system / sub-system /components. Such study shall include but not be limited to I

Power supply installations and short circuit faults on OHE system, assess the fire load, the Fire size (height & volume and gradients) and find out the Mitigation measures at Substations and Switching Stations. The Contractor shall develop a Fire safety Plan in compliance of NFPA – 130.

3.11 VERIFICATION, VALIDATION AND DEMONSTRATION (VVD) PLAN

3.11.1 The contractor shall prepare a Verification, Validation and Demonstration plan to validate and demonstrate system performance and reliability.

3.11.2 The Design Verification and Validation Plan, supplementary to the Design Plan, shall be prepared by the Contractor in order that design Verification and Validation activities are properly directed. The plan shall address , but not be limited to, the following:-

- (1) the objectives of each Verification phase and each Validation phase;
- (2) defined input and output criteria for each development phase;
- (3) identification of types and detailed methods of test, Verification and Validation activities to be carried out;
- (4) detailed planning of Verification and Validation activities to be carried out, including schedules, resources and approval authorities;
- (5) selection and utilization of the test equipment, and their test environmental conditions; and
- (6) Criteria on which the Verification or Validation is judged to be acceptable. These criteria shall be traceable to the design and performance requirements.

3.11.3 The Performance Deliverables for each system/ subsystem/ component as applicable and as identified in Particular specification shall be got verified and validated by the contractor. The Contractor shall prepare a Design Verification Table (DVT) that identifies the Contractor's proposed methodology for demonstrating compliance.

3.11.4 The DVT shall be supplied to the Engineer for his review and shall be monitored throughout the design and construction of the Works. Any changes to the DVT must be submitted to the Engineer for review before implementation.

3.11.5 The DVT shall identify the proposed Verification and Validation process (es) for each specification requirement and the acceptance criteria for achieving the requirement. The DVT does not relieve the Contractor of any other requirements of the Specification in relation to design review, Verification, Validation, conformance or planning.

3.11.6 For each item in the DVT, the Verification and Validation methods to be used shall be listed by the Contractor. The methods used shall be reviewed by the Engineer.

3.11.7 Subject to review without objection by the Engineer for each application, the Verification and Validation methods listed below are acceptable if implemented (whether singly or in combination):

- (1) Similarity – equipment and requirement are identical to those successfully applied on other projects.
- (2) Historical – requirement has been met by numerous previous designs.
- (3) Calculations and Drawings – for review.
- (4) Design Review – either scheduled or specifically targeted.

- (5) Development Test – performance testing on equipment or material under development.
 - (6) Type Test – performance testing of the as-built component, assembly or system.
 - (7) Routine Test – test every component, assembly or system.
 - (8) First Article Inspection (FAI) – acceptances of the exact look and fit of equipment.
 - (9) Inspection – formal inspection of the finished item.
 - (10) In Service – for service demonstration requirements only.
- 3.11.8 After each Verification or Validation activity, a Verification Report shall be produced including, as a minimum, the following:
- (1) The Verification or Validation results stating whether the objectives and criteria of the Design Verification and Validation Plan have been met; and
 - (2) The reason for failure if there is a failure, and proposal for remedial actions.
- 3.11.9 The Results of Verifications and Validations shall be demonstrated to the Engineer with evidence of records and tests.
- 3.11.10 Verification and Validation (V&V) shall include the demonstrations as required for the RAMS.

3.12 PROCUREMENT MANAGEMENT & MANUFACTURING PLAN

- 3.12.1 The Contractor shall prepare & submit for review by the Engineer, a Procurement Management & Manufacturing Plan comprising of the details on Procurement, Manufacturing and Delivery in respect of all items and goods. Separate parts of the plan shall also be prepared by the Contractor, his suppliers and subcontractors for their off-site activities. Each plan shall identify the scope of work to be applied. In relation to such scope of work, it shall, without limitation, define:
- (1) The organisation of the Contractor's personnel directly responsible for the day-to-day management of the manufacturing activity on or off the Site;
 - (2) the specific allocations of responsibility and authority given to identified personnel for the day-to-day management of the work with particular reference to the supervision, inspection and testing of the work;
 - (3) the interfacing or co-ordination required with the Contractor's other related plans;
 - (4) a full list of manufacturing method statements for major components, equipment and/or systems to identify the specific methods of manufacture;
 - (5) The format of the Material Control Schedule to monitor and control the production, manufacturing and delivery, for the Contractor, sub-contractors of any tier, suppliers and sub-suppliers;
 - (6) the list of procedures and work instructions to manage and control the quality of work during purchasing, manufacturing and delivery, including without limitation:
 - (a) The purchasing of items and goods and ensuring they comply with the requirements of the Specification, including (without limit) purchasing documentation and specific Verification arrangements for Contractor/the Engineer, inspection of material or manufactured product prior to release for use;

- (b) The manufacturing process so as to ensure compliance with the design;
 - (c) The manufacturing process so as to ensure clear identification and traceability of material and manufactured parts;
 - (d) The inspection & testing of inward materials/in process & final product to ensure specified requirements for the material and/or manufactured product are met;
 - (e) The identification of the inspection and test status of all material and manufactured products during all stages of the manufacturing process to ensure that only products that have passed the required inspections and tests are dispatched for use and/or installation;
 - (f) Review and disposal of non-conforming material or product so as to avoid unintended use;
 - (g) The assessment and disposal of non-conforming material and manufactured product and approval for reworking or rejection as scrap;
 - (h) The identification of preventive action so as to prevent recurrence of similar non-conformance; and
 - (i) The handling, storage, packaging, preservation & delivery of manufactured product.
- 3.12.2 The Contractor shall prepare and submit the inspection and testing plans to manage and control any test and inspection activities.
- 3.12.3 The Contractor shall propose a structured set of inspection hold points. The hold points shall be structured such that a formal hold point is allowed for each significant element of the manufacturing process. At each hold point, the Employer's Personnel/ the Engineer shall hold a formal inspection or advise that the inspection has been waived.
- 3.12.4 Once the inspection and any required remedial actions are completed to the satisfaction of the Engineer, the Engineer may give a notice of no objection to the results of Inspection as jointly witnessed. The Engineer will not withhold his notice of no objection for shipping unreasonably, provided all pre-delivery assembly and testing has been successfully completed.
- 3.12.5 The Material delivery plan shall cover each and every part of the delivery of all items and goods from the manufacturing premises to the Site. The delivery plan shall cover all lifting and handling activities and the steps to be taken to protect all items and goods from damage during each segment of the journey. The arrangements for customs clearances, inspections, highways permits etc. shall also be fully described.
- 3.12.6 The Material control schedule shall be automated, and shall detail the following information for each permanent major and minor material and significant component. The format of such a schedule shall include:
- a. Activity reference
 - b. Name, description of item/ activity;
 - c. Supplier/sub-supplier details;
 - d. Time required for manufacture/ construction;
 - e. Drawing information (where appropriate), title, drawing status, submission dates, shop drawings/ fabrication drawing preparation, etc.;

- f. Manufacturing process, manufacturing of test pieces, trial production, the Engineer inspection, monthly production of components and monthly supply of components;
- g. Assembly process, erection and assembly sequences (particularly for the first pieces) prior to shipment, test assemblies, monthly assembly requirement the Engineer inspection, testing of assemblies; and
- h. Purchase order date; and
- i. Transportation process, quality release from factory, factory storage, transport to dock, shipment.

3.12.7 The Schedule shall also be updated for:

- a. Factory Acceptance Test (FAT) Date
- b. Scheduled Shipping Date.
- c. Scheduled Job Site Arrival Date.
- d. Shipping Method Air/Ocean Classified/Unclassified.
- e. Actual Shipping Date.
- f. Actual Arrival date.
- g. Quantity Actually Received.

3.12.8 The schedule shall tie materials tracking to the respective work activity.

3.12.9 The Contractor shall continuously update this schedule and report upon the status of each item as part of the Contractor's regular progress reporting. From this base data, the Contractor shall prepare an exception report detailing all components that are in delay. This report shall be annotated with the reason for the delay and shall indicate what action the Contractor is taking to recover the lost time.

3.12.10 Manufacturing Submissions

The Contractor shall identify the specific methods of manufacture for major components, equipment and systems in the manufacturing method statements and develop those method statements to a degree of sufficient detail to be reviewed by the Engineer. All manufacturing method statements shall be submitted for review by the Engineer 56 days prior to the commencement of the respective manufacturing activities.

The Contractor shall prepare and maintain a full list of all the manufacturing method statements required for the Contract with submission status and review status, and shall submit to the Engineer upon request. The manufacturing method statement shall include, but not be limited to, the following:

- (i) The particulars of the materials to be incorporated into the items;
- (ii) The manufacturing process flowcharts in compliance with drawings and specification;
- (iii) The identification or referencing requirements for traceability of the manufacturing products;
- (iv) The identification of inspection and test check points and status of materials and final manufactured products; and
- (v) The handling, storage, packing, preservation and delivery of the manufacturing

products.

3.13 FACTORY ACCEPTANCE TEST PLAN

- 3.13.1 The Contractor shall prepare and submit for review by the Engineer the Contractor's Factory Acceptance Test Plan detailing and explaining how the Contractor will plan, perform, and document all inspections and tests that will be conducted to verify and validate the Works prior to delivery to the Site. The plan shall consist of a narrative description supported by graphics, diagrams and tabulations as required.
- 3.13.2 The plan shall contain but not be limited to the following topics:
- (1) The Contractor's strategy for inspection and Factory Acceptance Tests of all constituent parts of the Works and how this relates to the sequence of delivery and Procurement Management & Manufacturing Plan;
 - (2) The sequencing and interrelationships of the inspections and tests including all Quality Hold Points and Quality Control Points;
 - (3) The type and extent of inspection and Factory Acceptance Tests to be undertaken and the parts of the Works to be proven by that testing;
 - (4) The objective of each inspection or test, what particular design and operating criteria the test or inspection will prove and how the success of the test or inspection will be demonstrated or measured;
 - (5) Organisation Chart and CV of key personnel in inspection and test team;
 - (6) The plan for the production and submission of the inspection and test procedures to the Engineer for review including the submission of the inspection and test reports and records; and
 - (7) Type Tests, Routine Tests, First Article Inspections and any other tests constituting the Factory Acceptance Tests.
- 3.13.3 This plan shall clearly demonstrate the logic of all related processes the logical dependencies between the individual tests of the Works, and shall also show the interfaces and dependencies with the Contractor's delivery program. The Factory acceptance Tests shall be carried out in OEM's Premises/ factory / Manufacturing place.
- 3.13.4 Factory Acceptance Tests (FAT) shall include Type/Routine/Acceptance/Special Tests at Original Equipment Manufacturer (OEM) factory or the accredited test lab/ test house as approved by the Engineer. Routine tests shall include tests such as visual inspection, dimension check, electrical conductivity check, insulation check, calibration, mechanical and hydraulic tests and any other compliance tests. Type tests shall be performed on a sample of the complete equipment of each type and rating etc. based on SOGP and agreed standards. The FAT stage may also include some integration tests at the manufacturer's factory, which are performed to test the integration of the components that make equipment. Each software system (such as the SCADA system) shall be tested to simulate inputs and outputs including integration testing as possible, thereby reducing the overall integration risks to equipment at later stages. Each software FAT should take place in an environment as close as possible to the operational environment or suitably de-rated for application duty requirement.
- 3.13.5 The FAT Plan shall include a comprehensive list of the tests, Tests to be witnessed by representatives of various parties i.e. the Contractors' representatives, the Engineer or his representative, the duration of the test, Tentative dates, and minimum of 42 days

prior notice period to all representatives to witness the test.

- 3.13.6 The FAT Plan shall include details of inspection, testing and witnessing of the Contractor's and subcontractor's procurement and manufacturing activities at OEM's Factory. As a minimum, it shall include:
- a. First Article Inspection;
 - b. Quality Hold Points;
 - c. Type Tests; and
 - d. Routine tests.
- 3.13.7 The Contractor shall arrange for all equipment and systems manufactured for incorporation into the Permanent Works to undergo a Factory Acceptance Test (FAT) before shipment from the place of manufacture.
- 3.13.8 The Contractor shall be responsible for re-inspecting and re-testing any failed inspection and Factory Acceptance Test including regression testing on previously passed items.
- 3.13.9 Inspections and tests that are to be witnessed by the Engineer shall be sensibly grouped and scheduled so that as many inspections and tests as possible may be witnessed during a single visit.
- 3.13.10 The Contractor shall prepare two copies of an inspection or test report immediately after the completion of each inspection or test whether or not witnessed by the Employer or the Employer's Personnel/ the Engineer. If the Employer's Personnel /the Engineer has witnessed the inspection or test, he may countersign the inspection or test (i.e. whether or not the equipment being inspected or tested has passed satisfactorily) contained therein. If the Employer's Personnel /the Engineer has not witnessed the inspection or test (i.e. if a waiver has been granted, or for some other reason in accordance with the Contract), the Contractor shall forward two copies of the inspection or test report without delay to the Engineer. In case the results of the inspection or test do not meet the requirements of the Specification, the Employer/ the Employer's Personnel/ the Engineer may call for a re-inspection or re-test.
- 3.13.11 For standard equipment which is serial or bulk manufactured, manufacturer's type test certificates (or equivalent) may be acceptable, subject to review by the Engineer.
- 3.13.12 Test equipment and instrumentation shall be subject to approved calibration tests within a properly controlled calibration scheme, and signed calibration certificates shall be supplied to the Engineer in duplicate. Such calibration checks shall be undertaken prior to testing and, if required by the Employer's Personnel/ the Engineer, shall be repeated afterwards.
- 3.13.13 Materials and equipment shall not be released for shipment until all applicable inspections and tests including Factory Acceptance Tests have been satisfactorily completed.

3.14 INSTALLATION PLAN

- 3.14.1 The Contractor shall prepare and submit Installation Plan for the Engineer's approval.
- 3.14.2 The Plan shall be configured as a family of "stand-alone" plans and associated documents for each System and subsystems as required.
- 3.14.3 The plans shall be coordinated with each other and shall collectively define, describe and

encompass the Contractor's proposed methods, procedures, processes, organization, sequencing of activities, etc. and shall show how these combine together to assure that the Works truly meet the requirements of the Specification in respect of the subjects listed.

3.14.4 The Contractor shall prepare plans for the construction & installation activities on and off the site, and shall ensure that these are properly related to the subsequent testing and commissioning activity. Separate parts of the plan shall be prepared for other contractor(s) or sub-contractor(s) off-site activities

3.14.5 Where all or part of the works is within the DFCCIL Protection Zone, the contractor shall follow the guidelines issued by the Employer's appropriate authority. The Contractor shall submit to the Engineer for review, his construction method statement and detailed design of any Temporary Works proposed to be erected within this zone adjacent to DFCCIL properties.

3.14.6 The plan shall, without limitation, describe:

- (1) The organisation of the Contractor's staff directly responsible for the day-to-day management of the activity on or off the Site;
- (2) The specific allocations of responsibility and authority given to identified personnel for the day-to-day management of the Works with particular reference to the supervision, inspection and testing of the Works;
- (3) the interfacing or co-ordination required with the Contractor's other related plans;
- (4) the specific methods of construction and installation to identify any relevant method statements and develop those method statements to a sufficient degree of detail reviewed by the Engineer;
- (5) A detailed method statement which shall include but not be limited to:
 - (a) Description of main operations and sub-operations;
 - (b) Sequence of sub-operations;
 - (c) Quantities of the work and production rates to be achieved;
 - (d) Resources to be employed; and
 - (e) Quality checks to be carried out, supervision being exercised and safety precautions to be employed;
- (6) the list of procedures and work instructions to manage and control the quality of construction and installation works, including without limitation:
 - (a) The inspection and testing activities of incoming materials, in process and final product so as to ensure specified requirements for the material and/or product are met;
 - (b) The procurement of materials and ensuring they comply with the requirements of the Specification, including purchasing documentation and specific Verification arrangements for Contractor/Employer's Personnel / the Engineer inspection of material or manufactured product prior to release for use/installation;
 - (c) The construction processes including Temporary Works so as to ensure compliance with drawings and Specification. In addition, any software to be used in the construction, installation and commissioning process shall be

identified and details of the Verification and Validation processes for the software application shall be given;

- (d) The construction and installation process so as to ensure clear identification and traceability of material and manufactured product;
- (e) The identification of the inspection and test status of all material and manufactured products during all stages of the construction and installation process to ensure that only products that have passed the required inspections and tests are dispatched for use and/or installation;
- (f) The assessment and disposition of non-conforming material and product and approval for reworking or rejection as scrap;
- (g) The identification of preventive action so as to prevent recurrence of similar non-conformance; and
- (h) The handling, storage, packaging, preservation and delivery of product; and
- (i) The security control of the Site and the works area for Contractor's accommodation, storage, car park and other works facilities, etc.

3.14.7 The following particulars shall be submitted to the Engineer for review within 28 days of the Commencement of any Construction activity at site:

- (i) drawings showing the layout within the Site of the Engineer's and Contractor's accommodation, Project signboards, access roads and major facilities required;
- (ii) Construction Reference Drawings, Shop drawings etc.

3.14.8 Drawings showing the location of stores, storage areas, work areas and other major facilities shall be submitted to the Engineer for review as early as possible, but in any case not later than 28 days before commencement of construction of the facilities.

3.15 SITE MANAGEMENT PLAN

3.15.1 The Contractor shall submit Site Management Plan describing access, security, material storage, handing over and taking over of assets as per the requirement:

3.15.2 Access to Site

The Contractor will be given access to the Site in accordance with the Contract. The Contractor shall manage the execution within allocated Right of Way (ROW). The Contractor shall coordinate with contractor of package CP-302 for the same

3.16 SITE SAFETY PLAN

The Contractor shall establish and maintain various provisions of Site Safety Plan as detailed in Chapter-9:- Site Safety Plan of this GS.

- (1) The Contractor shall submit, as part of his Safety Plan, a Site Management Plan, and also designate a Safety Officer who shall be a person properly qualified to ensure the safety at construction sites.
- (2) The Contractor shall be fully responsible for the safety of the Works, his personnel, his sub-contractors' personnel, the public, and any persons directly or indirectly associated with the Works, or on or in the vicinity of the Site. The Contractor shall treat safety measures as high priorities in all his activities throughout the execution

of the work.

- (3) The Contractor shall submit to the Engineer, regular Site Safety Reports, and shall notify immediately the occurrence of an accident involving his staff or that of his sub-Contractors, or to any person within the area of the Site for which the Contractor is responsible.

3.17 HEALTH & ENVIRONMENT PLAN

- 3.17.1 The Contractor shall submit Health & Environmental Plan illustrating the intended means of compliance with the Employer's Safety, Health, and Environmental Requirements Manual. The Health and Environmental Plan shall contain sufficient information to demonstrate clearly the proposed method of achieving the environmental objectives with particular reference to Noise, Vibration, and EMC/EMI etc. The Contractor shall co-operate in any environmental audit conducted by DFCCIL or the Engineer.
- 3.17.2 Environmental Plans shall include the Contractor's proposed means of complying with his obligations in regard to:
 - (a) The Site Environment as found;
 - (b) System Environment as described in the Specification;
 - (c) policies, procedures, applicable regulations and mitigation measures
 - (d) SHE Manual.
- 3.17.3 Where the Contractor is required to become involved with traffic or footpath management activities, Traffic Management submissions shall be made by the Contractor for Engineer's review 56 days before implementation proving all relevant details and implications.

3.18 TESTING & COMMISSIONING MANAGEMENT PLAN INCLUDING TRIALS AND INTEGRATED TESTING & COMMISSIONING

- 3.18.1 The Contractor shall submit a Testing and Commissioning Management Plan in accordance with this Employer's Requirements.
- 3.18.2 The plan shall describe the testing & commissioning strategy to be followed for the project at different stages and shall include but not limited to
 - (1) Factory Acceptance Test (FAT),
 - (2) Site Installation Test (SIT) / Standalone Testing,
 - (3) Site Acceptance Test (SAT),
 - (4) Integrated System Testing,
 - (5) Trial Runs & Commissioning.

3.18.3 The Factory Acceptance Tests

The FAT stage confirms that the individual components and equipment are according to the design, specifications and the overall project requirements as defined in FAT above.

3.18.4 Site Installation Test / Standalone Testing

The SIT stage shall demonstrate that all the equipment or sub-systems are correctly installed and wired to suit operation. The tests mainly consist of visual inspection,

standalone test on each equipment / no-load tests and some operational tests. The SITs can be carried out on a site by site basis and in phases as the DFCC line sections get built and equipped.

3.18.5 Site Acceptance Test (SAT)

The Site Acceptance Test (SAT) stage is the stage when all installed equipment and sub-systems are tested to demonstrate that all the equipment and sub-systems can functionally operate, thus fulfilling all the performance requirements. SAT shall include all interfaces & integration with a range of tests such as verification of inputs and outputs for operating equipment, recording of tolerance margin for interfaces & Integration.

3.18.6 The contractor shall furnish a comprehensive schedule of Installation Tests, System Acceptance Tests and Integrated Testing & Commissioning Plan as required by the Employer Requirement's Part 2, Section VI, Volume -1 (GS) and Volume: 2 to 5 of PS and shall be furnished in accordance with the Installation Program.

3.19 PERMITS AND APPROVALS PLAN

The contractor shall assess the requirement and submit a Permits and Approval plan for approval of the Engineer. The Contractor shall obtain the permits and approvals as required from various statutory authorities like, local Government Body for water Supply, power Supply, Permission from Department of Post & Telegraphy, Certifications and approval of Architecture & Building Plan, Fire approval, Environment Clearance, Traffic, Fire approval, Clearance from CPCB including advance approvals if needed for any activity including Certification from Electrical Inspector to Government (EIG) and CRS sanction that system can reliably and safely be used for commercial operation of the Railway line.

3.20 TRAINING PLAN AND TRANSFER OF TECHNOLOGY (TOT) PLAN

3.20.1 Training Plan

The Contractor shall prepare and submit a Training Plan in a format and to a level of detail for review without objection by the Engineer as detailed in Chapter 13 of this GS. It shall be in accordance with Employer's Requirement.

3.20.2 Transfer of Technology Plan

The Contractor shall prepare and submit a Transfer of Technology Plan in a format and to a level of detail for review without objection by the Engineer. It shall be in accordance with Employer's Requirement.

3.21 OPERATION & MAINTENANCE PLAN

3.21.1 The Contractor shall prepare and submit for review by the Engineer an Operation & Maintenance Plan. The Plan shall include all the aspects related with the Monitoring, control & operation of the system / subsystem/ equipment and Maintenance thereof.

3.21.2 The Contractor shall develop an Operation & Maintenance Plan to suit staged commissioning of the system (if required) and to ensure the timely preparation of the Contractor's Operation and Maintenance Manuals and the 'As-Built' drawings in a format and to a level of detail reviewed without objection by the Engineer.

3.21.3 The Maintenance Plan & Maintenance Philosophy shall include the following:

- (1) Proposed periodicity for each type of examination, inspection or overhaul,
- (2) List of tasks to be carried out at each examination, inspection or overhaul,
- (3) Man-hours required for each task,
- (4) Replacement parts required at each examination, inspection or overhaul,
- (5) Different levels of maintenance activities.

3.22 SPARES MANAGEMENT PLAN

The Contractor shall submit the Spares Management Plan not less than 180 days prior to the proposed date of issue of the Taking Over Certificate for the Works. As part of spares management plan the contractor shall:-

- (1) Submit for review by the Engineer a Spares Management Plan to furnish a priced manufacturer-recommended list of spare parts, necessary to support continuous operation of all such equipment for a minimum period of 24 months after the commencement of Revenue Operations.
- (2) Supply the spares, test equipment etc. as per the respective Particular Specifications. The Contractor may please note that all Spares needed for replacement during Defect Notification Period shall be resourced separately and shall not be allowed to use the mandatory spares as identified in PS during the construction or Defect Notification Period.

3.23 DEFECT LIABILITY MANAGEMENT PLAN

3.23.1 The Contractor shall submit for review by the Engineer a Defect Notification Plan to repair, replace and perform any remedial item upon the Works identified by the Engineer during the Defects Notification Period. The Contractor shall:

- (1) Endeavour to complete all necessary work in a timely responsible manner;
- (2) Not proceed with any remedial work without the consent of the Engineer;
- (3) Submit a plan that details the methods and timing of any proposed work; and
- (4) Update the plan monthly, showing progress of the work and the time to completion.

(End of Chapter-3)

CHAPTER-4: PROJECT PROGRAM REQUIREMENT

4.1 GENERAL

- 4.1.1 The Contractor shall develop in detail, a logical method of executing the Works taking into account their complex nature and different phases and shall provide Project Implementation programs which reflect the detailed planning undertaken for implementation of the project.
- 4.1.2 The programs shall start with the Commencement Date of the Works as day one, are to be realistic, achievable and shall be accompanied by the detailed supporting Management Plans.
- 4.1.3 The Program activities shall be discrete items of work, which when combined and produces the definable elements, components, Milestones, Stages and Sections of the Works and clearly identify the completion obligations of the Contractor.
- 4.1.4 Milestones shall be an integral part of all Programs and all activities. Sequencing and interrelationships required to achieve each completion obligation shall be shown. Milestones shall not impose constraints that in a way affect the Program logic. Milestones shall not be introduced into any Program as constrained dates.
- 4.1.5 The critical path shall be clearly identified in the Program and fully described in the accompanying Program narrative.
- 4.1.6 Activity descriptions shall clearly convey the nature and scope of the Works. Programs shall take into account the activities of Precursor, concurrent, adjacent and follow on project contractors and any other activity that may affect the progress of the Works.
- 4.1.7 The Contractor shall also incorporate the Engineers requirement for additional activities, to further explain or subdivide complex or long duration tasks, without affecting completion dates.
- 4.1.8 The Contractor shall monitor its and its subcontractor's performance against programs to ensure its compliance with its obligations under the Contract. Monitoring of the Works shall include direct, daily monitoring of the progress of the Works and the preparation of return and computerized reports to be submitted to the Engineer. The reports shall include all necessary supporting data to apprise the Engineer of the status of the completion of the Works as described below:
- 4.1.9 The following Project Program submission shall be developed and submitted by contractor for the Engineer review within number of days (from the Date of Commencement) as specified below : -

Program Submission

S.No.	Programs	Submission
1.	Survey Plan and Program for Validation of Data Provided by Employer and Additional Surveys, if required by the Contractor.	56 Days
2.	Work Program	
2.a	Initial Version	56 days
2.b	Full Version	84 days
3.	Design Submission Program	56 Days

4.	Procurement Management and Manufacturing Program	90 Days
5.	Installation Program	180 Days
6.	Testing & Commissioning Program	180 Days
7.	Training Program	180 days

4.2 THE EXECUTION PHASES

The execution activity will include various phases of the implementation. The term Phases means a kind of stages of execution a system/ subsystem works or of a component or activity as generally would take place in a sequential manner. The next stage of activity can commence immediately after the completion of previous related activity. The Contractor will have generally following Execution Phases.

- (a) Design Phase,
- (b) Procurement, Manufacturing and Supply Phase,
- (c) Construction/Installation Phase,
- (d) Testing & Commissioning Phase and
- (e) Defect Notification Phase.

4.2.1 Design Phase

The contractor shall deploy the qualified team of the design Engineers and Experts as approved by the Employer Evidencing the experience of the design in relevant field and technology before commencement of Design Phase. The Design Phase shall be in 4 stages as detailed below:

- (a) Preliminary Design,
- (b) Detailed Design,
- (c) Construction / Installation Design & drawings and
- (d) As Built Documents.

4.2.2 Procurement, Manufacturing And Supply Phase

The Procurement, Manufacturing and Supply phase will constitute the Followings

- (a) Manufacturing/Procurement,
- (b) Factory Acceptance Tests (FAT),
- (c) Delivery to the contractor's stores at site and
- (d) Storage at the site Stores including establishing the Material Procurement tracking, receipt and issue procedures.

4.2.3 Construction & Installation Phase

Construction & installation Phase will constitute of the following:

- (a) Site Management including access/ ROW, and preparation thereof;
- (b) Availability of Construction reference Drawings;
- (c) Installation preparatory works like Foundations, first fix, site safety and quality assurance procedures etc.;

- (d) Equipment installation and
- (e) Submission of verified and As Built Documents.

4.2.4 Testing And Commissioning Phase

Testing and commissioning phase will constitute of the following:

- (a) Testing and Commissioning of all subsystems;
- (b) Quality assurance and RAMS demonstrations;
- (c) Integrated Testing & commissioning ;
- (d) Trial run including service trial
- (e) Training of Employer's Personnel;
- (f) Submission of Verified and As Built Documents.

4.2.5 O&M And Defect Notification Phase

The contractor shall develop a detailed Plan for Defect Notification Phase in consultation with the Engineer taking into account the Traction and E&M System/ subsystems/ equipment, Interface, RAMS demonstrations, Hazards not mitigated in the construction stage and carried forward to operation stage, maintenance support, T&P and spares created and the OEM's Recommendations on Maintenance support system etc. meeting the Operation & Maintenance requirement as under:

- (a) O&M activities,
- (b) Defect Notification Activities and plan,
- (c) Work shop Repair activities,
- (d) Support & Call out services,
- (e) RAMS demonstration and
- (f) Supply of O&M Manuals, Maintenance Schedules.

4.3 WORKS PROGRAM

- 4.3.1 The Works Program to be submitted under the contract shall be developed from the Outline Works Program as submitted by the contractor during the bid submission. The Work Program shall include a period for review by the Engineer/ Employer's Personnel of all stage of document submission while making overall project timeline adjusting various other activities.
- 4.3.2 The Contractor shall prepare and submit for review by the Engineer, his proposed **initial version** of the Works Program which shall provide full program details for the first six months of the contract and shall provide outline details for the remaining period of the contract.
- 4.3.3 The Contractor shall prepare and submit the **full Version** of the Work Program subsequently for review and approval of the Engineer.
- 4.3.4 The Works Program shall demonstrate by reference to its Sub Programs, Supplementary Programs and associated Management Plans, the sequence and duration of the activities and any restraints there so that the Contractor shall adopt to achieve Milestones and to fulfill all Contract obligations. The Works Program shall become the

basis of administration of the time-related aspects of the Contract.

- 4.3.5 The Contractor shall provide the Engineer with substantiation for each constraint whether target start, target finish or mandatory constraint entered by the Contractor into the Works Program. The number of constraints shall be kept to an absolute minimum.
- 4.3.6 The Works Program shall include activities for all the phases and stages of the Works, clearly showing all logical interdependencies and stages in the development of the Contractors design, procurement, installation, commissioning and setting to work. As a minimum, it shall include'
- (1) All works comprising the permanent works;
 - (2) Preparation, submission and review of Design Documents showing all items where review by the Engineer is required.
 - (3) Procurement of all major materials and items of Contractor's Equipment for the Works, including the dates orders are to be placed, manufacture period and the expected delivery date to the Site for each item.
 - (4) Any software development requirements and Validation time frames.
 - (5) All manufacture or prefabrication of materials of components.
 - (6) All design and installation of major Temporary Works.
 - (7) All activities associated with securing necessary permits and other statutory approvals for the works.
 - (8) Access and availability dates for all Project Contractors.
 - (9) All interfaces related to the project that may affect the progress of the Works.
 - (10) Testing and commissioning activities requirements.
 - (11) Training.
- 4.3.7 The Works Program shall be divided into Sub-Programs of manageable size addressing in more specific detail. The Sub-Program shall be as follows:
- (1) Design Submission Program
 - (2) Procurement Management and Manufacturing Program
 - (3) Co-ordinated Installation Program
 - (4) Testing and Commissioning Program; and
 - (5) Training Program
- 4.3.8 The submission of the '**full version**' of the Works Program shall include the Design Program, Procurement and Manufacturing Program and a preliminary version of the Installation Program and the Testing and Commissioning Program identifying all major installation, testing activities and associated interfaces.
- 4.3.9 The Sub-Program shall be further substantiated by the supplementary Programs as required by the Engineer.
- 4.3.10 The Contractor's Works Program shall comply with the following:
- (1) All program submitted in both hard copy and electronic data format.

- (2) All program shall be prepared using the latest version of CPM scheduling software Primavera Project Planner.
- (3) A standard Gregorian calendar shall be used for planning and execution of the Works. All Program submissions shall include details of the Contractor's allowance for Public Holidays and known-work periods. If a Milestone falls on a public holiday or non-work day it shall be effective the next working day.
- (4) The planning unit for the duration of all Program activities shall be the day. Any activity having duration of more than 28 days shall be divided into sub activities that shall not exceed 28 days.
- (5) CPM program shall reflect status using remaining duration and percent complete.
- (6) All program shall be fully resource loaded as appropriate or required by the engineer covering all stages and aspects of the Contract and shall include, but not be limited to:
 - (a) Major manpower for both design and installation.
 - (b) Number of items of Contractor's Equipment.
 - (c) Number of drawings and other design deliverables.
 - (d) Principal quantities of components or parts.
 - (e) Principle quantities of bulk materials inclusive of cabling, pipe, ductwork and equipment item etc.

4.3.11 All programs constituting the Works Program shall be organized in a logical work breakdown structure including work stages or phases. Each activity shall be coded to indicate, as a minimum, the work group or entity responsible for the activity, the area, facility or location and the Cost Centre in which the activity is included, from information provided in the pricing schedules. Milestones shall be coded so as to be separately identifiable. The Contractor may be required to assign additional activity codes as required by the Engineer.

4.3.12 The Contractor shall make provision for the time required for completing the design, design reviews/ approvals, revisions, construction, procurement, manufacture, supply, installation, testing, commissioning and integrated testing of the Works.

4.3.13 This period shall include but not be limited to design co-ordination periods during which the Contractor shall co-ordinate its design with those of interfacing parties, review procedures, determining and complying with the requirements of all government departments and obtaining all necessary permits.

4.3.14 This period will include co-ordination with all others whose consent, permissions, authority or license is required prior to the execution of any work.

4.3.15 The Work Programs including supportive details and revised versions shall be submitted to the Engineer for his consent in accordance with the provisions of the conditions of Contract.

4.4 DESIGN SUBMISSION PROGRAM

4.4.1 The Contractor shall prepare the Design Submission Program (for Design Phase and Construction Phase) which is to set out fully the Contractor's anticipated program for

the preparation, submission by the Contractor and review of the Design Packages, the issue of Notices by the Engineer for all stages of design. The 'Design Submission Program' shall cover all submissions during the Design Phase and the Construction Phase.

- 4.4.2 The Submission Program shall ensure that all submissions are properly coordinated with the Contractor's overall Works Program, particularly in respect of the following:-
- (i) Progress of design,
 - (ii) manufacture, installation and testing work;
 - (iii) Co-ordination with other Contractors;
- 4.4.3 Due allowances for the Engineer review process and the time needed for any re-submissions to be undertaken.
- 4.4.4 The Design Submission Program shall:
- (a) be deemed to be consistent with relevant Coordination Dates and latest work program;
 - (b) identify dates and subjects by which the Engineer's response should be made;
 - (c) make adequate allowance for periods of 28 days for review by the Engineer with extra time for the review of other bodies, if necessary;
 - (d) establish correlations by identifying, describing, cross-referencing and explaining the various Design Submissions including multiple submissions of the design for the different Work Segments;
 - (e) make adequate time allowance for the design and development of the specialist works /sub-contractor works
 - (f) indicate the interfacing design activities in respect of each of the other contractor / Interfacing Parties and external related parties and
- 4.4.5 The Contractor shall keep the Design Submission Program updated at intervals of not more than three (3) month throughout the Design Phase. Such updates shall be included as an exhibit in the Contractor's Monthly Progress Report.

4.5 PROCUREMENT MANAGEMENT & MANUFACTURING PROGRAM

- 4.5.1 The Contractor shall prepare and submit for review by the Engineer Procurement Management & Manufacturing Program that shall be an integrated part of the overall Works Program.
- 4.5.2 The Procurement Management & Manufacturing Program shall show the interdependencies between engineering disciplines as well as between the contractor and its subcontractors and suppliers. This Program shall demonstrate compliance with the requirements of the Submissions Program.
- 4.5.3 The Procurement Management & Manufacturing Program shall include a separate breakdown, supported by Material Controlled Schedule, which shall be a complete amplification of the Contractor's Program and equipment list, including those items which are subject to long lead time or component parts which are manufactured from countries outside the country of assembly and testing.

- 4.5.4 The Material Controlled Schedule shall be automated, and shall detail the following information for each permanent major and minor material and significant component. The format such a schedule shall include:
- (1) Name, description, supplier/sub-supplier details.
 - (2) Drawing information (where appropriate), title, drawing status, submission dates, shop drawings/fabrication drawing preparation etc.
 - (3) The manufacturing process, manufacturing of test pieces, trial production, Engineer inspection, monthly production of components and monthly supply of components.
 - (4) The assembly process, erection and assembly sequences (particularly for the first pieces) prior to shipment, test assemblies, monthly assembly requirement, engineers inspection, testing of assemblies and
 - (5) Transportation process, quality release from factory, factory storage to dock and shipment.
- 4.5.5 The Contractor shall continuously maintain this schedule and report upon the status of each item as part of the contractors regular progress reporting.
- 4.5.6 From this base data, the Contractor shall prepare and an exception report detailing all components that are in delay. This report shall be annotated with the reason for the delay and indicate what action the contractor is taking to recover the lost time.
- 4.5.7 The Contractor shall submit, as part of the Procurement and Manufacturing Program, Factory Acceptance Testing Program that shall describe all activities of the Factory Acceptance Tests.
- 4.5.8 The Factory Acceptance Testing Program shall be fully detailed, with the activities individually identifying all tests for which a certificate will be issued, and shall include activities for preparation, submittal and review of the test procedures.
- 4.5.9 The Factory Acceptance Testing Program shall demonstrate the logical dependencies between the individual tests of the works, and shall also show the interfaces and dependencies with the Contractor's delivery Program.
- 4.5.10 The Factory Testing Programme shall include details of inspection, testing and witnessing of the contractor's and sub-contractor's procurement and manufacturing activities. As a minimum, it shall include:
- (1) First article inspection;
 - (2) Quality Hold Points;
 - (3) Quality Control Points;
 - (4) Type Tests; and
 - (5) Routine Tests.

4.6 INSTALLATION PROGRAM

- 4.6.1 The Installation Program shall be submitted as directed by the Engineer. The Installation Program shall comply with the requirements of clause 4.3.10 above.
- 4.6.2 The Program shall include detailed activities describing all aspects of the installation of the works, to meet all Milestones given in the contract. It shall be clearly linked to the

Design Program, Procurement Management & Manufacturing Program and Testing and Commissioning Program to form an integrated part of the Works Program.

- 4.6.3 The Installation Program shall be fully supported by the Procurement Management & Manufacturing Plan and Installation Plan.
- 4.6.4 The Installation Program shall indicate the physical areas to which the contractors requires access, access dates, duration required and the required degree of completion for civil or architectural finishes prior to the access date.
- 4.6.5 The Installation Program shall take into account the requirements for arrival at port, delivery, storage, preservation and positioning of large items of the contractors equipment and permanent works and shall set out the contractors proposed delivery route for such items to the site.
- 4.6.6 All Installation tests shall be clearly shown in the Installation Program and shall include those interface tests required to be carried out by others to establish a time table for these tests.
- 4.6.7 Activities that may be expedited by the use of overtime, additional shifts or by any other means shall be identified and explained.
- 4.6.8 The Contractor shall highlight in his Installation Program any item, material, equipment, resource and support required from the 'Other Contractors with dates, duration and locations.
- 4.6.9 The Contractor shall ensure sufficient floats or slacks in all activities and avoid critical paths built in his Installation Program. In case critical paths cannot be avoided, the Contractor shall highlight any critical paths for the Engineer's attention.
- 4.6.10 In preparing the Installation Program, the contractor should note that the following conditions shall apply:
- (1) The Contractor shall not have exclusive access to any part of the site except by the specific consent of Engineer.
 - (2) The Contractor shall take note that concurrent time allocations for certain areas may be given to more than one contractor. The contractor shall coordinate his works in such areas with that of project contractors through the Engineer.
 - (3) The absence of a Program date or installation period for the contractor in a specific area shall not prejudice the right of the Engineer to establish a reasonable Program date or installation period for that area.
 - (4) The Contractor shall propose contingency plan to ensure that all the major Milestones can be met in case there is slippage in the installation activities.
 - (5) The Contractor shall comply with Milestones identified in the contract.

4.7 TESTING & COMMISSIONING PROGRAM

- 4.7.1 The Testing & Commissioning Program shall be submitted as stated in the PS or as directed by the Engineer and shall comply with the requirements of the clause 4.3.10 above.
- 4.7.2 The Contractor shall submit the Program that shall fulfill all the on-site testing & commissioning requirements. The Program shall clearly demonstrate the logic and highlight topics listed in the On-Site Testing and Commissioning Plan.

4.7.3 The Program shall be fully detailed, with activities individually identifying all tests for which a certificate will be issued, and shall include activities for preparation, submittal and review of the test procedures.

4.7.4 The Program shall demonstrate the logical dependencies between the individual tests of the Works, and shall also show the interfaces and dependencies with all of the Project Contractor's tests required to commission the Works and support the Commissioning Plan.

4.8 TRAINING PROGRAM

4.8.1 The Contractor shall prepare and submit for review by the Engineer, a Training Program covering all proposed formal training courses, delivery of training equipment and accesses by the Employer's personnel.

4.8.2 The Training Program shall be sufficiently detailed that the Employer can ensure the availability of staff for all the courses.

4.8.3 The Training Program shall include the requirements of Chapter-13: "Training and Service Life Support" including the Training activities of all sub-contractors and suppliers.

4.9 THE PROJECT CALENDAR

4.9.1 The Project Week shall commence on a Monday. A day shall be deemed to commence at 00:01 hour in the morning of the day in question.

4.9.2 Where reference is made to the completion of an activity or Milestone by a particular week, this shall mean by midnight on the Sunday of that week.

4.9.3 A 7-day-week calendar shall be adopted for various Works Programs which shall also display the rest day and holiday(s).

4.10 PROGRAM SUBMISSIONS

4.10.1 The Contractor shall submit all Programs described in this Chapter in conjunction with the Management Plans described in Chapter-3 to the Engineer.

4.11 PROGRAM REVIEW

4.11.1 The Engineer shall, within 28 days of receipt of the initial submission of any Program for review, either give a notice of no objection or provide specific details as to why a notice of no objection is not given. If the Contractor is advised that the Program is not given a notice of no objection, the Contractor shall amend the Program taking into account the comments and/or requirements and resubmit the Program within 14 days.

4.11.2 In the case of further resubmittals, the resubmission time shall also be 14 days.

4.12 WORKS PROGRAM REVISIONS

4.12.1 The Contractor shall immediately notify the Engineer in writing of the need for any change in the Works Program, whether due to a change of Scheme, Design or circumstances or for any other reason. Where such a proposed change affects the timely completion of the Works or any Section or Stage: the Contractor shall within 14 days of

the date of notifying submit for the review his proposed revised Works Program and accompanying Program Analysis Report. The proposed revised Works Program shall show the sequence of operations of all work related to the change and the impact of the changed work or changed conditions on the works and Project Contractors and their works.

- 4.12.2 If at any time the Engineer considers the actual or anticipated progress of the work reflects a significant deviation from the Works Program, he may request the Contractor to submit a proposed revised Works Program. Upon receipt of such a request the Contractor shall submit within 14-days a revised Works Program, together with an accompanying Program Analysis Report and Narrative Statement that shall demonstrate the means by which the Contractor intends to eliminate the deviation.

4.13 PROGRAM ANALYSIS REPORT

- 4.13.1 The Contractor shall submit a Program Analysis Report that shall, in narrative format, describes the basis and assumptions used to develop all Program submissions. The Program Analysis Report shall be prepared in a format having been reviewed without objection by the Engineer and contain as a minimum the following:

- (1) Cycle times and work sequences;
- (2) The deployment of Contractor's Equipment and labour;
- (3) The production rates used in determining duration;
- (4) The shifts assumed in determining duration;
- (5) The breakdown of labour requirements by trades;
- (6) The schedules of quantities used in developing the Program, to the extent that such information is not provided elsewhere;
- (7) Interfaces with the Engineer and Project Contractor's and other constraints; and
- (8) Any assumptions used in the Program.

- 4.13.2 The Program Analysis Report shall be in sufficient detail to enable the duration, leads and lags in logic diagram to be reconciled and substantiated, and to enable the projected levels of labour (by trade) and staff and flows of goods, materials and equipment to be substantiated.

4.14 MILESTONES

Milestones have been derived from Conditions of Contract. These are the broad key deliverables and Contractor is required to develop project program to achieve these deliverables and dates. Accordingly contractor should set his own internal targets which are commensurate with these Milestones and incorporate in his all internal schedules for approval of Engineer. The details of Milestones are mentioned under appropriate clauses in Part 3, Section VIII of Bidding Documents.

4.14.1 Milestone Report

- (1) The Milestone Report shall be prepared in a format reviewed by the Engineers Representative and identify and state the status of :-

- (a) All Milestones that are planned to be achieved in the reporting period or earlier but have not been achieved;
 - (b) All Milestones that have been achieved in the reporting period;
 - (c) All Milestones that are planned to be achieved in the next reporting period; and
 - (d) Any Milestones that appears unlikely to be achieved on time.
- (2) The Milestone Report shall identify for all relevant Milestones, the planned dates, the actual dates achieved, and where the original planned dates are forecast to be unachieved, the revised dates identified in the contract, as the same may be revised time to time in accordance with the contract.
- (3) The Milestone Report shall also provide an explanation for any deviation from the planned dates. Measures taken or required to recover the Program delays shall also be identified.

4.15 MONITORING OF PROGRESS

The Contractor during the progress of the Works shall constantly monitor its own and its subcontractor's performance to ensure its compliance with its obligations under the Contract and progress as per agreed Work Program. The Monitoring of the Works shall include direct daily monitoring of the progress of the Works and preparation of written and computerized reports to be submitted to the Employer's Personnel and the Engineer as required. The Progress reports submitted shall include all necessary supporting data of the status of the completion of the Works including preparing and submission of PERT/ CPM/ BAR/ GANTT charts and "S" Curves.

4.16 PROGRESS REVIEW MEETINGS

- 4.16.1 The Engineer/ Employer's Personnel will conduct Progress Review Meetings (PRM) to be held monthly with the Contractor at appointed dates and times.
- 4.16.2 The Employer's Personnel /Engineer may convene at his discretion, at any time upon reasonable notice to the Contractor, any meeting, either on or off the Site, to discuss and address any aspect of the Works or the Contract.
- 4.16.3 The Contractor shall attend monthly Progress Review Meeting or any other meetings called by the Employer's personnel / the Engineer in order to review the arrangements for future work, Works in progress or other issues set out in the Meeting Agenda. The meetings shall be attended by the nominated Project Director/ Project Manager(s) of the Contractors, and his support Experts of Relevant fields/ activities and other Senior personnel who shall arrive properly briefed for all aspects of the meeting and shall be empowered to make executive decision in respect of the execution of the Works.
- 4.16.4 The Minutes of the Meeting (MOM) signed & issued by the Engineer shall constitute an official record of matters discussed. However, such MOM shall not replace or dilute any of the Employer's requirement specified in the Contract. The Contractor shall take specific approvals, instructions or decisions in writing from the Engineer for all documentations and submissions as specified. Such meetings may be attended by representatives of all Interfacing Parties and other stakeholders as deemed fit by the Engineer.

- 4.16.5 A first meeting as a 'Kick off Meeting" of the work/project shall be organized within two weeks of 'Letter of Acceptance'. The meeting shall be attended by Contractor's Representatives and Employer's Personnel / the Engineer. During the meeting the activities related to the project planning, scheduling, and monitoring and control shall be discussed and finalized as required including planning on deliverables for project monitoring & control, Works Program and other Inputs as desired by the Employer.

4.17 MONTHLY PROGRESS REPORT

- 4.17.1 The Contractor shall prepare Monthly Progress Reports covering all aspects of the execution of the Works. Such Monthly Progress Reports shall be in writing and shall be delivered to the Engineer by the 7th day of the month following the month of Monthly Progress Report. The Monthly Progress Report shall take account of work performed up to and including the last day of the month to which the monthly progress report relates and shall be prepared in accordance with Chapter-15, Appendix-1:"Monthly Progress Report".
- 4.17.2 The Monthly Progress Report shall include an executive summary and contain clear and concise statements in respect of every significant aspect of the Works including, without limitation, the requirements specified in this Specification.
- 4.17.3 The Monthly Progress Report shall contain evidence that document and supports the progress of the Works to the satisfaction of the Engineer.
- 4.17.4 The Reports, documents and data provided shall be an accurate representation of the current status of the Works and of the work to be accomplished and shall provide the Engineer with a sound basis for identifying problems and deviations from planned work and for making decisions.
- 4.17.5 Important events, construction/Installation activities working of new machinery, weather effects or any occasion advised by the Engineer shall be video graphed. The recording shall be done or converted to .avi format and presented in electronic storage device with appropriate voice recording describing the event.

4.18 QUARTERLY REVIEW MEETINGS

- 4.18.1 The Employer may convene Quarterly Review Meetings in Delhi at approximately three months intervals. The Engineer will notify the Contractor the date of such Quarterly Review Meetings not less than 14 days before they are to be held.
- 4.18.2 Quarterly Review Meetings shall be held to review the overall progress of the Works in the context of the Project as a whole and to address and resolve any issues relevant to the execution and progress of the Works. Such Quarterly Review Meetings will be chaired by the Employer or his delegate. The Contractor shall have in attendance of one senior representative of the Director level from each of the companies acting as leader or sponsor of the Contractor if it is a Joint Venture, Consortium or Partnership whenever necessary and required by the Engineer.

4.19 IT REQUIREMENT FOR DFCCIL

- 4.19.1 "DFCCIL is in the process of implementing an Enterprise wide IT System. In view of ERP package SAP being implemented in DFCCIL, Contractor must provide the following data

to DFCCIL Head Office/CPM Offices in the Microsoft Excel Templates/Format released by DFCCIL Head Office/CPM Offices.

4.19.2 As part of scope of work the Contractor will ensure the following:

- (1) Ensure that required data of the Contracts Work Program and Physical progress of the activities defined in the Works Program must be provided in the templates defined by DFCCIL to be uploaded in the system using software defined by DFCCIL.
- (2) Work Program, Revised Works Program and Revision in Planned Work in the Activities, would also be uploaded in the system using software defined by DFCCIL through templates provided by it.
- (3) In order that the Works Program Data provided by the Contractor could be uploaded as it is in the system, Contractor must adhere to the following conditions regarding the length of the Codes/Numbers defined in their project Management Tool (e.g. Primavera or Microsoft) for the Project Structure Elements:
 - (a) Project ID/WBS Element Codes/Numbers must be unique and must not exceed a maximum length of 20 Characters (Alpha Numeric).
 - (b) Activity IDs/Numbers must not exceed a maximum length of 4 Characters (Alpha Numeric).
- (4) Upload of drawings and designs created by Contractor as per the classification using document management system of SAP.
- (5) Online measurement book entry (Record of Works) and all bills along with supporting documents as per the screens defined by DFCCIL.
- (6) Asset details needs to be updated in the system in format prescribed by DFCCIL.
- (7) GIS (Geographical Information System) application will use Autodesk suite (MAP 3D as desktop GIS & AIMS for WEB GIS) and Oracle 11g/spatial as a central repository. Information about the assets details (i.e. alignment drawing coordinates and attributes) will be provided by the contractors. Network asset details in the form of maps, reports will be available to all the authorized users through web as soon as the asset details are submitted by the contractors and imported in the system.
 - (a) Geo-referencing of alignment on WGS-84 coordinates.
 - (b) Capture and upload of geo-referencing coordinates of the assets in to GIS.

4.19.3 Contractor need to feed/provide the data in the IT system as per mechanism and method devised by DFCCIL. For putting data into system Contractor needs to make arrangement of connectivity, if required and also needs to bear the cost of any licensees required for the Contractor to access the DFCCIL IT System.

4.19.4 In case interoperability is required for movement of information and data in a seamless manner between contractor IT system and that being developed by DFCCIL, it will be the responsibility of the Contractor to ensure the same.

(End of Chapter- 4)

CHAPTER-5: DOCUMENT MANAGEMENT REQUIREMENT

5.1 GENERAL

- 5.1.1 During the life cycle of a project, contractor would be required to produce different types of documents to facilitate the planning, tracking/ monitoring progress and reporting of the project. Documents range from Studies/ Reports, Management Plans, Resource plans, financial plans and project Implementation Program, Design & Process documents, Calculations, Drawings, Vendor Technical Specifications, supplier contracts, post-implementation reviews, change request forms and project status reports etc.
- 5.1.2 It shall be ensured by the Contractor that documentation meets the Purpose and the content is sufficiently detailed to communicate fully. Success of project is crucially dependent on documents produced for it.
- 5.1.3 The Contractor shall maintain a PROJECT MANAGEMENT INFORMATION SYSTEM (PMIS) and share the information with the Employer's PROJECT MANAGEMENT INFORMATION SYSTEM (PMIS) as per details in Chapter-15, Appendix-7: "PMIS Requirements and Procedures".
- 5.1.4 The Contractor shall comply with the following requirements of the Employer regarding the Document Management System.
- Document Flow Process,
 - Document Approval Process,
 - Document and Drawing Numbering System,
- 5.1.5 The Contractor shall submit hard copies of all drawings, data of the documents and copy of transmittal along with a soft copy transfer electronically in the agreed format. Contractor will share the softcopies as advance information. However the reviews will only be made on hard copies and shall be preserved in hard copies with endorsed signed copy. The work shall be executed based on the latest hardcopies of the drawings and documents.

5.2 TYPES OF DOCUMENTS

- 5.2.1 The Contractor shall identify the requirement of Documents, designs, drawings and furnish a Document Management Plan. Types of documents that would be required to be submitted by the contractor are as enumerated below but not limited to:

1) Reports and Studies

Inception Report, , Simulation study, Site Survey reports Monthly Progress Report, Inspection Reports, Notes of Discussions/ Minutes of Meeting(MOM)/ Investigation Reports etc.

2) Project Management Plans

As per Chapter 3

3) Programs & Schedules

As per Chapter 4 **Process & Procedures documentations**

Specification Design/ document/ Drawing submission, approval of technology/

equipment, Makes, Alternate options, Design Change, site access, handing over, etc.

4) Design Phase Submissions

Design phase submission will constitute the following:

- (a) Preliminary Design Submissions along with Design Report, Scheme/ Drawing Calculations and supportive documents;
- (b) Detailed Design submissions along with Design Report, Scheme/ Drawing Calculations and supportive documents;
- (c) System Requirement Specifications, Proofs & Evidences of achieved System assurance and RAMS with V&V, Check lists and
- (d) Vendor Performance Specifications and Drawings.

5) The manufacturing / supply phase will constitute Manufacturing by OEM Factory Acceptance Tests (FAT) and delivery to the contractor's stores at site.

6) Construction / installation, testing and commissioning phase submissions will constitute the following:

- (a) Equipment installation drawings,
- (b) Construction Reference Drawings,
- (c) Interface Management and combined Services Drawings,
- (d) Monitoring, Control & Protection Logics and fault diagnostics,
- (e) O & M and Design Manuals with Itemized specifications, monitoring & Control Process, Diagnostics and O&M procedures with test results reports,
- (f) As built drawings with Drawings for all equipment and sub-systems/systems supplied & installed, location wise Equipment Bill of quantity, Asset Register,
- (g) RAMS demonstrations reports and
- (h) Process papers for Permits and approvals.

5.2.2 For the Equipment, sub-system and components therein, the Contractor shall submit documents and drawings describing function description, product description, interface requirement description, RAMS requirement description, Life cycle calculations, type test & routine test specifications, list and details of spares, related calculations etc.

5.3 DOCUMENT CONTROL PROCEDURE

5.3.1 Within 28 days after Commencement Date, the Contractor shall submit a Document Control procedure to the Engineer for review as below but not limited to;

- (a) The document shall be well organized. It shall have a clear logical sequence and should be organized in chapters, sections, and sub-sections with meaningful headings, including diagrams, tables, or figures whenever appropriate.
- (b) The document shall be self-contained as far as possible without much cross references, unless otherwise there is a reason to do so.
- (c) The Contractor shall use configuration management to ensure that the system is correctly configured. The Contractor shall ensure that a configuration control

program is maintained. The Program shall ensure that the configuration of each item is recorded and maintained during the life of the Contract including Defect Notification Period.

- (d) Every document and drawing shall have a unique traceability. The Contractor shall ensure that all submissions are correctly numbered in accordance with the schedule. The sequence code shall be a unique sequential number for each submission for each particular subject. Revision numbers shall be used when a re-submission is required. The resubmission shall have the reference of the previous revisions including the revisions of the references used in the drawings and documents to ensure traceability.
- (e) Each Document and Drawing shall have a title, Document number, Revision Number, Date and list of Reference documents/ drawings (along with Reference Number, Revision and Date). The revision status and date of preparation of the submission shall be clearly indicated at the header of each page of the submission.
- (f) The Documents and CAD drawings shall be described, Titled, numbered and detailed as per the Appendix-2 of this GS.
- (g) To establish integrity of the Document / Drawings, each sheet / page of the submission shall be sequentially numbered giving page number of the document with reference of total pages i.e. x page no. of y pages. Every Para of the document shall be sequentially numbered without duplication of para numbers.

5.3.2 Each document shall be accompanied by a brief Explanatory Notes / introduction / Report to explain the Purpose, which subsystem - part of the Works to which the submission refers to, lists of the documents enclosed, with the submission and describing in outline how all relevant requirements of the Employer's Requirements are achieved by the proposals.

5.3.3 The Contractor's document approval system shall specify the level of authority for approval of all documents before submission to the Engineer and in accordance with Quality Assurance.

5.3.4 The system of issuing documents shall ensure that pertinent documents are issued to all appropriate locations.

5.3.5 A document change or re-issue system to ensure that only the latest revision of a document can be used; and should contain:

- (i) Contract number;
- (ii) Discipline;
- (iii) Submission reference number;
- (iv) Revision indicator and date; and
- (v) Description of Change for each revision with clouding and flagging in the drawing.

5.4 REQUIREMENTS OF DOCUMENT SUBMISSION

5.4.1 All the documents, drawings and Designs shall be submitted with the endorsement thereon the Documents as under:

(a) Certificate of the contractor in the effect that “the submission is prepared, checked and issued by the qualified engineers of the Contractor” conform to the satisfactory, safe and reliable performance,

(b) Statement of Exception/ Deviation from the Contract: ‘NIL’

5.4.2 Deviation if any to the particular specification shall be got approved before implementation from the Engineer in writing and endorsed in this effect on all documents affected by such deviation.

5.4.3 The documents involving Field changes in the approved design or due to site constraints shall be endorsed by the contractor with a Statement of “NO additional financial implication” unless approved otherwise by the Engineer.

5.5 DRAWINGS TO BE SUBMITTED BY THE CONTRACTOR

5.5.1 Drawings produced by the Contractor for submission to the Engineer shall generally be to ISO, A1 size as under but not limited to;

- (a) Schematics,
- (b) General Arrangement Drawings,
- (c) Site layouts, Equipment layouts,
- (d) Construction Reference Drawings of Permanent works,
- (e) Combined Service drawings,
- (f) Detailed Interface Drawing,
- (g) Drawings for Temporary Works etc. and
- (h) Revised drawing due to design/ site changes.

5.5.2 They shall display a title block with the information as detailed herein Drawing and CAD Standards duly quality checked and Sign endorsed by the Preparer, Checkers and issuer along with the Design Certificate.

5.5.3 The contractor shall provide six sets of all stage drawings along with read only electronic version of the same on Electronic Media to the Engineer.

5.6 LEVEL / QUANTUM OF SUBMISSION

The Contractor shall adopt top-down approach and carryout submissions of the following levels in a logical sequence for review by the Engineer:

- (a) System works related submissions shall show the total system including the configuration block diagrams, operating principle, system features and functions, capacity, expandability, interconnection within the subsystem, between subsystems and between other Contract Packages.
- (b) Equipment level related submissions shall show the specification on electrical, mechanical and functionality of the equipment/materials employed for the system and the subsystems.
- (c) Design calculations shall demonstrate the performance of the system and subsystems.

- (d) Installation Design related submissions.
- (e) The Contractor shall submit supportive documents, copy of certificates from relevant parties and authorities as required.
- (f) Equipment test certificates, Reports, calibration certificates from manufacturers and laboratories.

5.7 DOCUMENT SUBMISSION PROGRAM

- 5.7.1 The Contractor shall submit documents for all the stages - design, manufacturing/supply and Installation, testing and commissioning etc. to the Engineer for 'No Objection'.
- 5.7.2 The Contractor shall submit a Document submission Program. The submission program shall identify all submissions to be furnished, submission titles, submission numbers and target submission dates for Management Plans and the Drawings of each stage.
- 5.7.3 Submission of Unlisted or undefined proposals / alternate proposal shall not be part of Document Submission Program however shall be addressed in the same manner.
- 5.7.4 The Document Submission Program shall:
 - (a) Be consistent with and its principal features integrated into the Works Program, and show all relevant Milestones and Key Dates;
 - (b) Identify dates and subjects by which the Engineer's decisions should be made;
 - (c) Make adequate allowance for periods of time for review by the Engineer and other review bodies;
 - (d) Indicate the design interface and co-ordination periods for each Other Contractor;
 - (e) Include list of requisite design details for each and every component or equipment of all sub-systems and systems and
 - (f) The Contractor shall update the Submittals Schedule suitably in accordance with the observations of the Engineer if any deviations.
- 5.7.5 The Contractor shall submit the Document Submission Program to the Engineer as indicated in Chapter-3 of this GS, and thereafter up-dated versions thereof at intervals of not more than 3 (three) month.

5.8 DOCUMENT SUBMISSION PROCEDURE

- 5.8.1 For each stage of submittal, the Contractor shall prepare a Submission Response Request (SRR) carrying the date of submission, the submission reference number as defined above, the submission title, the stage of submission (e.g. Inception Report, Simulation Report, Detailed Design, etc.), and the signature of the Contractor's Representative.
- 5.8.2 The Documents and Drawings shall be submitted under the signatures of the Project Manager of the Contractors to establish proper issue & Control of the documents. The authority will not be delegated below the rank of Project Manager.
- 5.8.3 The submission shall be accompanied with a checklist duly signed by the Preparer and Checker of the Drawing/ document.
- 5.8.4 The submission shall be accompanied with Exception Statement on Deviations if any to

the Specifications.

- 5.8.5 Each Document / drawings shall be signed by the Preparer (who has prepared the Document/drawing), the Checker (who has checked the document/ drawing) for conformance to specifications, and the issuers (who has verified the document for the purpose, and issued after Careful examination) to demonstrate that document have gone through the process of quality assurance.
- 5.8.6 All the documents, drawings and Designs shall be submitted with the endorsement thereon the Documents as under:
- (1) Certificate of the contractor to the effect that “the submission is prepared, checked and issued by the qualified engineers of the Contractor and has been properly reviewed by the Contractor, according to the Contractor’s Project Quality Assurance Plan”, thereby confirming its completeness, accuracy, adequacy and validity and conformance to the satisfactory, safe and reliable performance,
 - (2) Compliance with all relevant clauses of the Employer’s Requirements;
 - (3) Conformance to all interface requirements;
 - (4) Certifying that it is based on auditable and proven or verified calculations or design criteria;
 - (5) Has taken account of all requirements for approval by statutory bodies or similar organizations, and that where required, such approvals have been granted;
 - (6) Statement of Exception/ Deviation from the Contract: ‘NIL’
- 5.8.7 Deviation if any to the particular specification shall be got approved before implementation from the Engineer in writing and endorsed in this effect on all documents affected by such deviation.
- 5.8.8 The documents involving Field changes in the approved design or due to site constraints shall be endorsed by the contractor with a Statement of “NO additional financial implication” unless approved otherwise by the Engineer.
- 5.8.9 Each submission shall be made in 6 copies, if not specified otherwise. The Contractor may supply the additional copies for specific documents, on the request of the Engineer or to meet specific requirements, if any of the PS.
- 5.8.10 The submission not accompanied with full set of associated documents shall be considered incomplete.

5.9 ENGINEERING REVIEW COORDINATION

- 5.9.1 Throughout the Design Stage, the Contractor shall attend monthly design review meetings with the Engineer. At these Engineer’s review meetings, the Contractor shall present information, drawings and other documents to the Engineer in respect of all submissions Program to occur during the following four week period. The Contractor’s presentations shall be in sufficient depth to enable the Engineer to obtain a clear understanding of the Contractor’s proposals and to discuss the methodology and process used in reaching the proposed design solutions. Unless otherwise directed by the Engineer, all meetings shall be convened in Engineer’s Office or Contractor’s Main Office or at the Site Office or at any other location as decided by the Engineer.
- 5.9.2 The Contractor shall record all of the Engineer’s observations and any agreed actions

resulting from the Engineer's review meeting and shall address each of these fully before submission of the respective documents for formal review.

5.10 ENGINEER'S REVIEW

- 5.10.1 The Engineer will complete his review of the submission within 28-days, and communicate review comments in writing or on marked up drawings/documents.
- 5.10.2 Within two weeks of the receipt of the Engineer's comments, the Contractor shall resubmit the submittals/ documents needing resubmission.
- 5.10.3 Where the comments are minor, the same may be clarified by calculations, part prints, etc. as acceptable to the Engineer and included in the Contractor's next submission.
- 5.10.4 Should the Engineer considers the submission to be unacceptable, the Contractor shall revise and re-submit the entire submission within two weeks, unless otherwise agreed with the Engineer.

5.11 ENGINEER'S RESPONSE

- 1) The Engineer will respond in one of the following three ways:
 - (a) Notice of No Objection
 - (b) Notice of Objection (With "A" Comments)
 - (c) Notice of No Objection with Comments
- 2) Definition of Engineer's response:
 - (a) "Notice of No Objection": if following his review of the submission, the Engineer has not discovered any non-compliance with the Contract, the Engineer will issue to the Contractor a formal "Notice of No Objection" (NONO). A NONO from the Engineer, irrespective of with or without comments does not in any way imply the Engineer's consent of the submission nor does it remove any responsibility from the Contractor for complying with the Contract. Issue of a NONO from the Engineer entitles the Contractor to proceed to the next stage of the Programed work.
 - (b) "Notice of Objection (With "A" Comments)": if following his review of the submission the Engineer discovers major non-compliance, discrepancies or omissions etc. that in his opinion are of a critical nature, the Engineer will issue a "Notice of Objection" (NOO) with type "A" comments. The Contractor shall revise and reissue the submission addressing the Engineer's comments. Following the issue of a NOO by the Engineer, the Contractor is not entitled to proceed to the next Programed stage on the path in the relevant network as previously approved by the Engineer until all of the Engineer's comments have been fully addressed and a NONO is issued.
 - (c) "Notice of No Objection" (With Comments)": if following his review of the submission the Engineer discovers discrepancies or omissions etc. that in his opinion are not of a critical nature, the Engineer may issue a "Notice of No Objection" (NONOC) with Comments. The Contractor shall respond to the comments, agreed and incorporated prior to inclusion in the "Construction Package" Following the issue of a NONOC by the Engineer, the Contractor is entitled to proceed to the next stage of the Programed

work subject to the inclusion of amendments necessary to address the comments.

(End of Chapter-5)

CHAPTER-6: DESIGN REQUIREMENT

6.1 GENERAL

This Employer's Requirement identifies the Design requirement for execution of the DFC 2x25kV AC Electrification, Signalling & Telecommunication, E&M and associated works including the preparation and submission of the design of the Systems Works and it shall be read in conjunction with the 'Design Criteria,' Basic Design Philosophy and Requirements for Design and Project Quality Assurance Plan as described in this General Specification (GS) and Particular Specification (PS) of 2x25kV AC Electrification, Signalling & Telecommunication, E&M and associated works and other relevant Appendices. These requirements are subdivided into Design Phase and Construction Phase, and those that are of general application.

- 6.1.1 The Works shall be executed in four phases viz. the Design Phase, the Manufacturing/Supply Phase, Construction/ Installation Phase and Testing & Commissioning Phase.
- 6.1.2 The various phases of the project will overlap with each other. The Design Phase shall have 4 stages – Preliminary Design Stage, Detailed Design Stage, Construction/Installation Design Stage and As Built Documents Stage, overlapping with the various phases of project execution.
- 6.1.3 The Contractor shall ensure that his design is accurate and in compliance with Employer's Requirements and the Specifications which are deemed to be part of the contract as defined in Conditions of Contract. The Contractor shall be responsible to ensure that when the Works are completed, the same shall be fit for the intended purpose as specified in the Contract.

6.2 GENERAL DESIGN CRITERIA

The system designed by the Contractor shall meet the application duty requirement during its serviceable life as envisaged and shall be aesthetic, User friendly, Modular, Expandable, Durable & Maintainable, Environment Friendly, Energy Efficient, EMC/EMI compatible, High Designed life as per the Industry Benchmarks, Meets the Reliability, Availability and Maintainability Standards, interfaced seamlessly with other systems in conformance to safety standards and the specifications

6.2.1 Durability and Maintenance

- (1) The Permanent Works shall be designed and constructed such that they shall endure in a serviceable condition throughout their minimum design lives as described in the Design Criteria and standards contained in the PS and technical specifications to minimize the cost of operation and maintenance whilst not compromising safety or the performance characteristics of the railway.
- (2) Equipment(s), where supplied, shall be of a quality and durability to fully meet the performance and operational requirements described in the Design Criteria.

6.2.2 Operational Requirements

- (1) The Permanent Works shall be designed to permit the DFCCIL to operate satisfactorily at a maximum permissible speed for freight trains in accordance

with Particular Specifications.

- (2) It is a requirement that the Indian Railway (IR) remains operational during the construction / Installation phase.

6.2.3 Aesthetics

The Permanent Works shall be designed to achieve an aesthetic character and provide a feeling of design commonality throughout the project.

6.2.4 Human Factors

The Contractor is required to observe the guidance contained within ISO/TR 16982:2002 and the ergonomic design of systems supplied shall be subject to acceptance by the Engineer.

6.2.5 Safety, Health and Environment Considerations

The design of the Permanent Works shall be according to Indian laws and regulations related to Safety, Health & Environment Requirements. Safety, Health & Environment aspects shall be kept in mind during the Design/Construction/Installation and Testing & Commissioning phases, requirement for which has been specified at appropriate places in the bidding document. It shall be the overall responsibility of the Contractor to ensure compliance of Safety, Health & Environment aspects at all times conforming to the provisions mentioned in this Bidding document.

6.2.6 Quality Control

Quality control aspects shall be kept in mind during the Design/construction/Installation and testing & commissioning phase, requirement for which has been specified at appropriate places in the bidding document. It shall be the overall responsibility of the Contractor to ensure deliverables of quality products at all times conforming to the provisions mentioned in this bidding document.

6.2.7 Reliability, Availability, Maintainability and Safety of Design

The System Design shall ensure Reliability, Availability, Maintainability and Safety standards, as specified in the Bidding document.

6.3 OBLIGATIONS AND RESPONSIBILITIES OF THE CONTRACTOR

- 6.3.1 The Contractor shall be responsible for the design, layout, construction/Installation, manufacture, supply, testing and commissioning of the 2x25kV AC Electrification, Signalling & Telecommunication, E&M and associated works under the scope of this package and shall ensure that the designs are accurate and in compliance with Employer's Requirements of Particular Specifications (PS) and General Specifications (GS).

- 6.3.2 The Contractor shall be fully responsible for the suitability, adequacy, integrity, durability and practicality of the Contractor's proposal. The Contractor shall ensure that the Works are fit for the intended purposes meeting application duty requirement.

- 6.3.3 The Contractor shall undertake that the designers shall be available to attend discussions with the Engineer and Employer at all reasonable times during the Contract period. The Designer shall be the same entity as proposed by the Contractor at the time of pre-qualification unless otherwise approved by the Employer. The Contractor shall furnish Designer's Warranty in the format provided in contract forms of bidding

documents.

- 6.3.4 The Contractor is responsible for assuring the quality of the System designs and shall produce and establish a Quality Management System specifically to meet the Contractual Obligations and Quality Assurance Plan as referred in GS and the PS.
- 6.3.5 The Contractor shall ensure that the system Designs conform to Safety, Health and Environment requirements as specified in this GS, and Project SHE Manual as detailed in this Employer's Requirements.
- 6.3.6 Wherever there is any inadequacy, insufficiency, impracticality or unsuitability in or of the Employer's Requirements or any part thereof, the Contractor's proposal shall take into account, address or rectify such inadequacy, insufficiency, impracticality or unsuitability. If there are discrepancies between documents referring the same subject, the more stringent criteria shall be followed, unless otherwise the order of precedence described in the relevant documents is not applicable.
- 6.3.7 All technical solutions, schemes and materials etc. shall be fully compatible with those used by the beneficiary and should not be in conflict with the applicable rules / codes / manuals and standards as well as legislations in India.
- 6.3.8 The Contractor shall co-ordinate with the Other Designated contractor's viz. Civil, Building & Tracks (package CST - 302), and the Contractors working at adjacent sections of DFCCIL etc. to meet the Interface requirement Obligations specified in the Interface Matrix and Interface Management Plan.
- 6.3.9 The Contractor shall submit the Designs of the Works for review by Engineer.
- 6.3.10 To demonstrate the compliance to Quality assurance, all the documents, designs and the Drawings shall be signed /endorsed by;
- Contractor's representatives who has Designed / prepared,
 - Contractor's representatives who has checked,
 - Contractor's representatives who has issued the drawings/ document i.e. the Senior Design Engineer of the Contactor's Design Team.
- 6.3.11 The Contractor shall certify that:-
- The Works have been or will be designed, manufactured, installed and otherwise constructed and to the applicable standards available using proven up-to-date good practice.
 - The Works will, when completed, comply with enactments and regulations relevant to the Works.
 - The design of the Works have taken or will have taken full account of the effects of the intended manufacturing and installation methods, Temporary Works and Contractor's equipment.
- 6.3.12 The Contractor shall also provide an undertaking from the Designer for his Designs for suitability, adequacy, practicality and absolutely meeting the Employer's Requirements as detailed in Chapter-15, Appendix 3: "Design Certificate". The undertaking shall also state that reasonable skill and care expected from a professionally qualified and competent designer experienced in works of similar nature has been exercised. This shall be applicable for such Designs which may be or have been prepared, developed issued by the Employer, or any of Contractor's consultants, his sub-Contractors and/or his qualified

personnel/persons or cause to have been prepared, developed or issued directly or indirectly by the Contractor. All the aforesaid shall be applicable notwithstanding the fact that any part of the work may have been inadvertently accepted, passed and paid for by the Engineer or Employer. The Contractor shall endorse a design certificate in requisite format thereby demonstrating that the Designers have been fully checked the design as being compliant with all QA procedures and fully compliant with the requirements of the Contract.

- 6.3.13 The Contractor shall, whenever the Engineer so requests, provide information and participate in discussions/ presentations that relate to design matters.
- 6.3.14 The Contractor shall furnish all the information as required and as consulted by the Employer in regard to Public Consultations, as specified in Publicity and Public Relations to this Employer's Requirements.
- a. all plans, programs, reports, calculations, manuals and drawing as specified in 'Document Submission Plan' of this Employer's Requirements and in accordance with this GS and PS of the Systems work to the Engineer to seek the consent of the Engineer and issue "Notices of No Objection".
 - b. additional information and supportive documents as required by the Engineer to verify the requirement and / or required for co-ordination of the design of Other Contractors.
 - c. The Designs within the specified dates as per 'Document Submission Program' of this Employer's Requirements.
- 6.3.15 Contractor shall submit the Preliminary Designs, Detailed design, Construction Design, As-Built Documents and other design Documents as specified in Quality Assurance Requirements of this Employer's Requirements.
- 6.3.16 The Contractor shall carryout Engineering studies and comparative evaluations to ensure that the designs incorporate features to achieve optimum performance of all elements. The design of 2x25kV AC Electrification, Signalling & Telecommunication, E&M and associated woks shall be reliable, energy and cost efficient with due considerations to the local climate conditions, safety, ease of installation, operation, maintenance and future replacements.
- 6.3.17 The Design shall include the Design Calculations in soft and hard copies in verifiable forms including the relevant formulae, Schematics & drawings, Design Manual and checklist etc.

6.4 CONTRACTOR'S ORGANIZATION DURING DESIGN PHASE

6.4.1 Project Organization

- (a) Within 28 days of Commencement Date, the Contractor shall submit the Project Organization chart (as a part of Mobilization plan) during the Design Phase, equipped with the functions in a manner as described in 'Quality Assurance Requirements' of this Employer's Requirements. The Plan shall show the management structure and state clearly the duties, & responsibilities and authority of each key and staff member. The Contractor shall keep this plan updated and resubmitted whenever there are changes in the Manpower mobilization plan.

- (b) The Contractor shall establish a Design Office at his Main Site Office or at a place agreed by the Engineer.
- (c) The Contractor's Personnel/team shall be deployed as per the Mobilization plan.
- (d) The Contractor shall propose and deploy qualified, experienced & competent personnel appropriate to the type and magnitude of the design involved in the Design Team with the Engineer's consent for each key personnel during the Design Phase. Full details regarding their qualifications and experience shall be submitted to the Engineer for his consent.
- (e) The Contractor's Design Team shall be independent of the Construction Team in his Organization. The Design team shall be carried forward to construction phase design to ensure that the Contractor's design development strictly complies with the Detailed Design which has received 'Notice of No Objection' from Engineer.
- (f) All meetings and discussions relating to design shall be held in the Design office or in the office of Engineer/Employer and/or as instructed by the Engineer.
- (g) The Contractor shall ensure that the Design Team continues to be represented at Site at all times by staff whose seniority and experience are to the satisfaction of the Engineer and whose representative is available on the Site as necessary or as required by the Engineer.
- (h) The Contractor shall replace a person of the Design Team immediately if the Engineer/ the Employer's Personnel seek a replacement citing the reasons. The Contractor shall ensure that the demobilization of the person from the site/ office within seven (7) days of the advice and shall have no further connection with the Works in the Contract.

6.5 EMPLOYER'S DRAWINGS & DOCUMENTS

The Employer's Data and Drawings are attached in this Contract Package Part – 4 – Reference Documents 'Employer's Data and Drawings' respectively to express the Employer's concept and /or intent bearing functions, purposes and structural forms of the Permanent Works as detailed hereunder:

(1) Alignment Drawings

- (a) The Alignment Drawings basically contains the Indicative Horizontal and Vertical Alignment of the Track-ways for the whole Mainline, Connecting Lines, Loop Lines, Sidings (yard layout for each Station) and connecting lines to IR etc. under the Contract; and also the Definite Right of Way (ROW) available all along the Alignment including the Junction / Crossing Stations in line with the list of ROW attached herein as 'Part – 4 – Reference Documents .
- (b) The Alignment Drawings enclosed in the Employer's Drawings are indicative and are further subject to confirmation from the Other Designated Contractor(s) viz., CST.
- (c) Contractor shall be responsible for the information's' use, correctness, adequacy and applicability.

- (d) Contractor will be responsible for verifying its correctness for his own designs portion of the Design stipulated in the Particular Specifications.
- (e) The Contractor shall also ensure that during the Design development the designs include complete scope of work
- (f) The contractor's design shall be consistently developed without infringing the Right of Way, the Structure Gauge and the Clearances as stipulated in the Specifications.
- (g) The contractor shall develop schemes and designs for diversion of EHV / HV and LV power line crossings and other utilities coming in the jurisdiction under his scope of work. The Contractor shall take up suitable technical designs for the Works in the vicinity of these utilities in close interface with these parties to enable safe designs for passage of electrical conductors and equipment at these locations.
- (h) The locations and Chainages are tentative and indicative only. It is the Contractor's sole responsibility to verify their precise nature and location before undertaking the Detailed Design.

(2) General Arrangement Drawings (GAD)

- (a) The Employer's General Arrangement Drawings (GADs) are a set of reference drawings which shows the Employer's concept of each Permanent Works above, are indicative and for reference only. These shall be further developed by the Contractor as part of Detailed Design/ drawing as relevant and shall be coordinated with Other Contractors.
- (b) The GADs as relevant to this package are included in the Part – 4 – Reference Documents.

(3) General Drawings – Containing the general map of the alignment route and the Site location map,

6.6 CONTRACTOR'S REVIEW OF EMPLOYER'S DESIGN & DRAWINGS

The Contractor shall review the indicative General Arrangement and other Drawings and suggest his modifications and improvements based on site conditions and as a result of the Simulation Study conducted by him and approved by the Employer.

6.7 VALIDATION OF DATA & ADDITIONAL SURVEYS

6.7.1 The Contractor shall verify the available data for adequacy and applicability. The Contractor shall plan and Program for the validation of the drawings and data provided by the Employer.

6.7.2 The Contractor shall conduct additional surveys if required as below:

- (a) Survey for Earth Resistivity as appropriate to achieve the required earth value, touch and step potential.
- (b) Electromagnetic Interference from AC traction currents and to mitigation measures of adjacent circuits and ensuring safety. Special precautions and preventive measures which may become necessary against EMI for any adjacent

continuous metalwork such as fencing, wires and cables affecting safety to the public or to the circuits from induction effects of 2 x 25 kV, 50 Hz, AC traction currents or for foundation designs for the Traction Structures, passage of OHE through over line structures, those affecting adjacent IR lines in operation or any other purpose as considered necessary. The Contractor shall carry out his own independent survey and inform the Employer of the results of such survey recommending the mitigation measures.

- (c) The Contractor shall design and provide the mitigation measures for the entire installation to be provided by him. In regard to the mitigation measures to be taken on the installation of outside bodies and Indian Railways, the Employer shall decide the agency through which such mitigation measures shall be taken up.

6.7.3 The contractor shall conduct surveys as required for Contractor's Simulation Study under the scope of work specified in Particular specifications. Based on the final validation Survey and additional survey the contractor shall formulate a proper preliminary design parameters for finalizing the Detailed /Construction designs.

6.8 RESIDUAL & SUPPORTIVE WORKS TO DELIVER THE PERMANENT WORKS

- (a) It shall be the Contractors responsibility to carry out all the residual/ supportive works as essential to deliver the Permanent works and take precautions necessary to ensure that the survey works are accurate, accountable and secure.
- (b) The Contractor shall ensure but not limited to performing all necessary calculations in a clear presentation of computations and results in order to facilitate verification by the Contractor himself and by the Engineer of the results arrived at. If any computer simulations have been performed the basis, formulae and the constants adopted shall be indicated justifying their use.

6.9 DESIGN STAGES

6.9.1 The principal requirements of the Design Phase are the production of

- Preliminary Design,
- Detailed Design,
- Construction/Installation Design and
- As Built Documents & drawings.

6.9.2 The Design Phase shall be considered complete upon the issue of a "Notice of No Objection" by the Engineer in respect of the last Detailed Design Submission which shall comprehensively and completely form the Detailed Design for the whole of the Works.

However, the Engineer reserves the right to review and satisfy for adequacy of design, the obligations and intended purpose of the design of the Works in compliance to the Contract.

6.9.3 A conceptual flow of the Design Stages and Review Procedure in the Design and Construction Phases is depicted hereunder :

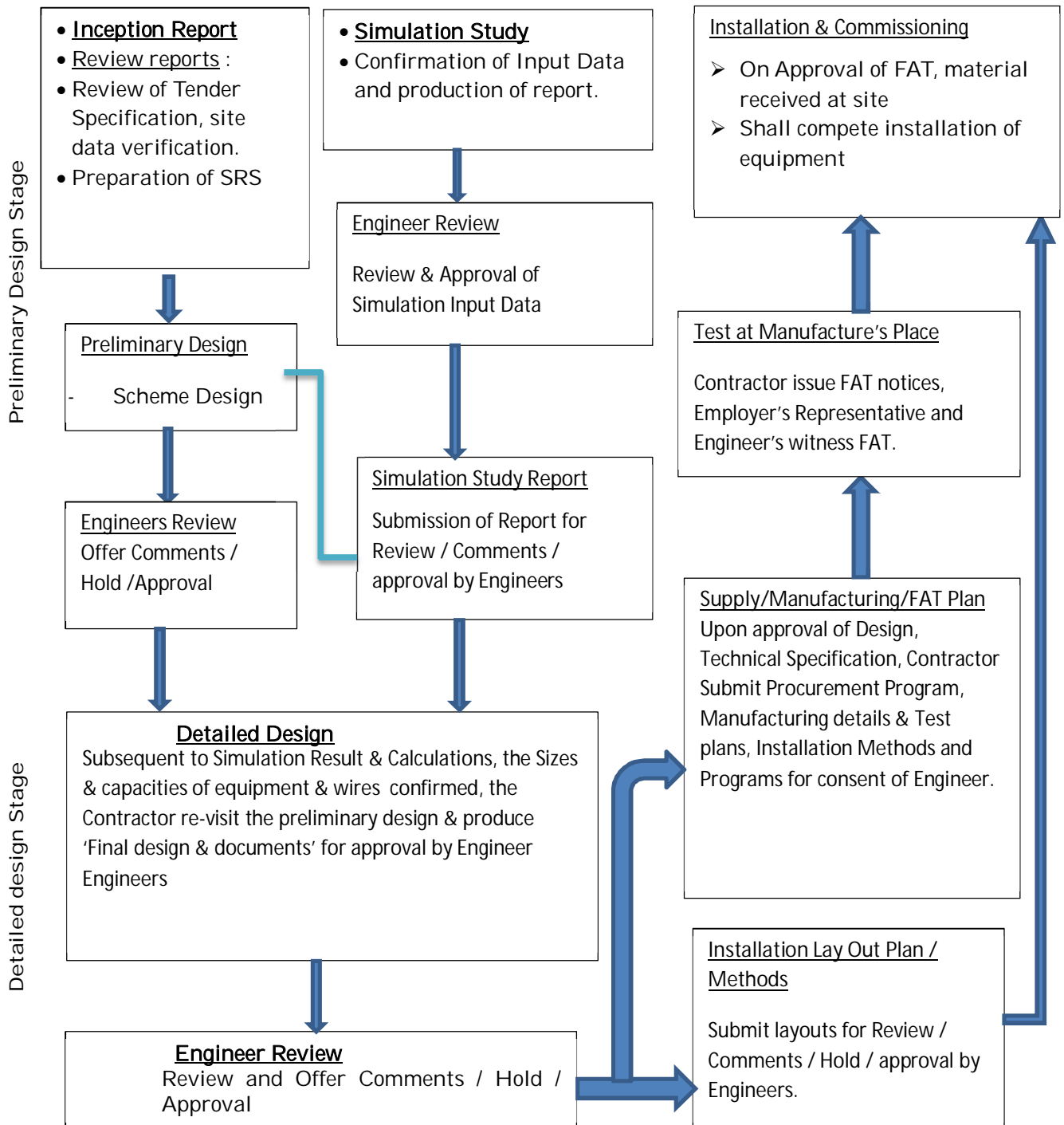

Fig – Design Submissions

6.9.4 Design submissions including Preliminary Design, Detailed Design, Construction / Installation Design, As-Built Documents shall be endorsed with a valid "Design Certificate" as specified.

6.10 INCEPTION REPORT WITH STUDY ON PS, GS AND STANDARDS

6.10.1 Within 42 Days from commencement date, The Contractor shall furnish an Inception Report for approval of the Engineer describing the Project Information, Scope of Work, Project Management Setup, Organization Chart with Key Experts, Project Manager, Communication Matrix, Site office, office for designer, Methodology to deliver identifying the Sub-systems, key activities, key performance parameters, key dates of submissions, document submission program and Initial Work Plan etc.

6.10.2 The Inception Report shall be sufficiently detailed to demonstrate the approach to design for the work under the Scope including but not limited to the main component of system works.

6.10.3 The Contractor shall review all applicable data, criteria, standards, directives and information provided to him as the basis for design. Any apparent inconsistencies or erroneous information shall be brought to the attention of the Engineer as a Review Report a part of Inception report. Such information shall not alleviate the Contractor from his responsibilities under the Contract.

6.11 SYSTEM REQUIREMENT SPECIFICATIONS

6.11.1 Within 63 days of Commencement of Work, the Contractor shall prepare a System Requirement Specifications (SRS) as reproduced from PS in sequence as interpolated with Information/ provisions specified in GS, other contract documents or relevant Standard as numbered for each line. SRS will form as a minimum, operational, functional, performance and design requirements of the proposed system.

6.11.2 While the Para number Reference of original document will be retained, the source & Para reference of the content inserted shall also be mentioned in the Document.

6.11.3 The Document may identify or list the deliverables essential for RAM and Safety.

6.11.4 The System Requirement Specifications (SRS), serving as a means of system requirement management and the Contractor's top level design document, shall state all the requirements completely and unambiguously and how each requirement can be verified and validated.

6.12 PRELIMINARY DESIGN STAGE

(a) The preliminary design stage, as a minimum, shall identify the function of each system, sub-system, equipment or other element within the overall SRS and specify the relationships and interfaces between each element of the system including the systems of the interfacing elements of other Contractors.

(b) Equipment and interconnection specifications, with supporting calculations, shall be developed at this stage. Submissions shall clarify and confirm as necessary all technical aspects of all interfaces with other elements of contractor's overall design and of any interfaces with systems of other contractors.

- (c) The Contractor shall submit with each submission a compliance matrix identifying the Cross-references of SRS and submit a Design Verification Table (DVT).
- (d) Ergonomics of the designed system shall be verified at this stage.
- (e) Mock-ups/prototypes shall also be developed during this stage.

6.12.1 Preliminary Design

- (a) Within 90 days after the Commencement Date, the Contractor shall submit the Preliminary Design as described herein and as further detailed in Employer's Requirements.
- (b) The Preliminary Design Report shall contain the following but not limited to
 - (i) Project Information,
 - (ii) Reproduced the scope of work,
 - (iii) Environment & Boundary conditions,
 - (iv) Functional requirement & Performance requirement,
 - (v) Operational & Maintenance requirement,
 - (vi) Assumptions,
 - (vii) Design criterion,
 - (viii) Concept Design and Typical Design,
 - (ix) Standards and Reference Documents,
 - (x) The System description identifying subsystem, equipment and components.
 - (xi) The System's Application Duty Requirement,

6.13 DETAILED DESIGN STAGE

- (a) During the preparation of the Detailed Design, the Contractor shall in particular ensure that:
 - (i) All standards and regulations relevant are compiled;
 - (ii) Calculation and Analysis are complete;
 - (iii) The designs meet the application duty requirement;
 - (iv) Safe design;
 - (v) The system designs meet the reliability , availability, and maintainability obligations as per best of industry standards;
 - (vi) All main and other significant elements are delineated;
 - (vii) All protocol of tests and trials, all selection of material and equipment are complete;
 - (viii) Full account of the effect on the Signaling, Telecommunication, 2X25 kV, 50 Hz, AC, Traction Electrification, E&M and associated works of the proposed methods of Installation, Testing & Commissioning and of the Temporary Works has been taken into account;

- (ix) All surveys, investigations and testing necessary to complete the design of the above Works in accordance with the Contract have been under taken.
- (b) Based on the Contractor's Technical proposal and Preliminary Design as consented by the Engineer, the design of the Works shall be fully developed in detail as a part of the 'Detailed Design' by the Contractor.
- (c) The 'Detailed Design' shall be prepared in accordance with the requirements of
 - (i) Train operation requirement as identified in DFCCIL's Business Plan;
 - (ii) Particular Specifications including but not limited to;
 - (iii) Design Criteria;
 - (iv) Codes, Standards and Manuals as applicable on Indian Railways and applicable regulations / legislation in India and
 - (v) Existing International norms/standards wherever required.
- (d) The 'Detailed Design' documents and drawings as developed and updated shall be submitted to the Engineer for consent and issue of a Notice of No Objection.
- (e) During the preparation of the 'Detailed Design', the Contractor shall in particular:
 - (i) Complete all calculations and analysis;
 - (ii) Delineate all main and all other significant elements;
 - (iii) Complete selection of material & equipment including specifications,
 - (iv) Assess and take full account of the effect on the Works of the proposed methods of construction, installation, testing and commissioning for permanent and temporary works.
 - (v) Complete the validation of all the data provided by the Employer including all the additional surveys, investigations and testing as considered necessary by the Contractor to develop the Detailed Design of the Works in accordance with the Contract.
 - (vi) Draw up a set of the Construction Reference Drawings (CRD) as summarized in Requirements for Submission of Documents and Drawings
- (f) Engineering studies and comparative evaluations shall be performed to ensure that the designs incorporate features to achieve optimum performance in consonance with economy of all elements.
- (g) The Detailed Design shall include the Construction Reference Drawings, the Works Specification, the Detailed Design Report, the Construction Method Statement and all other contents of the Detailed Design Submittals as summarized in 'Employer's Requirements -- Part 2, Section VI, Volume 2 to volume 5: Particular Specifications
- (h) The Contractor shall divide the Works into Works Segments in accordance with the "Definition of Works Segments" given in 'Basic Design Philosophy and Requirements for Design' of Employer's Requirements - Particular Specification and shall identify the Works Segments in the Works Program and the Design Submission Program.

- (i) The Contractor shall sub-divide all the Design into Design Packages which shall be identified in the Design and Certification Submission Program. Each Design Package shall be a clearly and easily identifiable part of the Design and shall address the design requirements as described herein. The Design Packages shall facilitate the review and understanding of the Design as a whole and shall be produced and submitted in an orderly, sequential and progressive manner to suit the manufacture/supply, installation, testing and commissioning sequence and the Works Program.
- (j) Separate Design Submissions may be prepared for those major elements to be procured through sub-contract which include design. Where such work is to be procured by the Contractor on the basis of outline design, design briefs and performance specifications, such documents may be submitted as Detailed Design Submissions.
- (k) Upon completion of Internal Authorization Process, as specified in 'Quality Assurance Requirements' of this Employer's Requirements, the Contractor shall submit the Detailed Design as described herein, to the Engineer for consent and issue of a "Notice of No Objection".
- (l) Upon issue of the "Notice of No Objection" in respect of the Detailed Design Report, the Contractor shall complete the design in all respects and produce 'Good For Construction Drawings' (GFC).
- (m) The issue of separate NOCs for such sub-divisions shall be conditional upon the Contractor having demonstrated, to the satisfaction of the Engineer, the adequacy of the ratings of the equipment safety, suitability for application duty including its effects on other Contracts for the whole Works Segment has been fully accommodated in the Detailed Design Package to ensure reliable and safe operations of the completed system.
- (n) The Contractor shall provide to the Engineer two original full and latest editions of the publications / Technical Standards including the Codes and Standards and other documents that the Contractor proposed to use for carrying out the Detailed Designs, including other communications between Engineer and the Contractor relevant to this Contract as part of the Inception Report. These publications / documents shall be for the sole use of the Engineer and upon completion of the works shall become the property of the employer.
- (o) The Temporary Works as essentially needed shall also be identified as a separate Works Segment and the design of those shall be proposed by the Contractor early enough to have sufficient discussions on Engineering and procedural issues with the Engineer so as to meet the intent of the Employer's Requirements. The Contractor shall submit the agreed design of the Temporary Works as part of the Detailed Design to the Engineer for consent .

6.14 DESIGN REQUIREMENTS DURING CONSTRUCTION PHASE

- 6.14.1 The principal requirements during the Construction Phase are the production, submission and seeking consent of the Engineer for the "Good For Construction" Drawings, Construction Design, the As-Built Documents and the O&M Manuals.
- 6.14.2 All construction phase drawings and documents shall be revised, upgraded, detailed and integrated in the Construction Design Package.

6.14.3 The Contractor shall fully verify and endorse all Drawings and documents with Design Certificate during Construction Design Package through the Internal Authorization Process as specified.

6.14.4 Construction Design

- (a) The Construction Phase for the whole or a part of the Works shall commence immediately upon the issue by the Engineer of a 'Notice of No Objection' in respect of the relevant Detailed Design Submission, subject to the availability of the Site in accordance with the agreed Program for site hand over by the Employer. Such "Notice of No Objection" may be issued by the Engineer in respect of a Detailed Design Submission covering a major/ distinctive part of the Works/ activity in accordance with the Design Submission Program. However, construction shall not be commenced until the appropriate Construction Reference Drawings and other documents forming the Construction Design Package have been endorsed as "Request for Construction" through the Contractor's Internal Authorizing and Quality Assurance Process.
- (b) The Construction stage drawings shall be coherent and complete set of Document in line with the preliminary Design Document along with a copy of the NOC issued previously by the Engineer for the relevant portion, shall be submitted to the Engineer. The detailed design reference shall also be incorporated in such submissions
- (c) Detailed Design Drawings shall form part of the Drawings to be used for installation purposes and construction shall be strictly in accordance with the relevant Design Stage.
- (d) Only those drawings and documents that have been endorsed and certified and have received consent as above shall be issued to the Site
- (e) The Construction Phase shall include the completion and submission of the Construction/Installation Design and the As-Built Documents
- (f) The design of the permanent and temporary works of this contract shall be carried out in accordance with the Contractor's Quality Assurance Plan in compliance with the Employer's Requirements.
- (g) the Contractor shall produce the respective Construction Design Package which shall include, but not limited to,
 - (i) The 'Good For Construction Drawings',
 - (ii) Updated construction stage related Project Management Plans;
 - (iii) The updated Works & Material Specifications;
 - (iv) Updated Technical Drawings;
 - (v) Updated detailed design Report;
 - (vi) Method Statements/ work procedures/ construction sequences;
 - (vii) The Interface Drawings related to the other Construct Contracts;
 - (viii) Field change Drawing & Design if any.
- (h) The Good for Construction Drawings and Construction Reference documents shall include site sketches, dimensioned drawing, fabrication and shop drawings,

erection plan and sequences etc.

- (i) Construction stage related Project Management Plans as detailed this GS and Particular Specification shall be updated and endorsed by the Contractor through the Contractor's Internal Authorizing Process as being in accordance with the Technical Design for which the Contractor has received the "Notice of No Objection".
- (j) Construction stage Works & Material Specifications as detailed in this GS and Particular Specification shall be updated and be endorsed by the Contractor through the Contractor's Internal Authorizing Process as being in accordance with the Technical Design for which the Contractor has received the "Notice of No Objection".
- (k) The Construction Design and Construction Technical Drawings including updated Works Specifications / Method Statements etc. shall be derived directly from the Detailed Design as approved by the Engineer including the incorporated changes as commented by the Engineer attached to the Notice of No Objection.
- (l) The Working/ Fabrication Drawings and the Construction Practicing Documents shall be prepared to facilitate construction to meet the required workmanship as well as technical requirements.
- (m) The updated Method statements shall be prepared to check and monitor the Works in terms of SHE requirements described in Project SHE Manual and Quality Assurance.
- (n) Upon the Internal Authorization Process, the Contractor shall submit the Construction Design Package as the "Request for Construction" to the Engineer for consent and issue of a Notice of No Objection. Upon receipt of the "Notice of No Objection" or "Notice of No Objection With Comments", the Contractor shall endorse the original paper drawings in respect of the Working Drawings as "Good For Construction" as per the Internal Authorization Process and issue.
- (o) If the Engineer so requires, the said endorsed original paper drawings shall be re-submitted to the Engineer, who shall, if has no objection to the contents of the re-submission, further endorse the original paper drawings by stating that he has no objection to the proposed Working Drawings. On endorsement by the Engineer, the original drawings will forthwith be returned to the Contractor as Working Drawings to be issued to Site.
- (p) The "Good For Construction Drawings" and the Working Drawings shall be used for construction purposes and only those drawings and documents that have been endorsed and certified through the procedure and have received "Notice of No Objection" as above or those that the Engineer has expressly stated as not requiring his endorsement shall be issued to the Site.
- (q) The Construction of the Works shall be strictly in accordance with the Construction Design Package, for which "Notice of No Objection" has been issued by the Engineer and "Good For Construction" drawings has been issued as per the authorization process detailed as above.
- (r) The Construction Design Package may be divided into multiple submissions

for different Work Segments as required to be consented by the Engineer. In such a case:

- (i) Construction Design and Drawings in respect of each Work Segment shall be submitted for the entire scope of work.
- (ii) All Submittals which are commonly applicable to the subsequent submissions shall be submitted in the initial submission and each submission shall include correlated and interdependent submittals.
- (iii) All the divided Construction Design Submissions shall be integrated and compiled into one package at the time when the final submission is made as the Construction Design Package.
- (s) If the Contractor identifies the need for any change to the design due to site conditions or any other reason, the Contractor shall produce a Design Change Notice or Field Change Notice in accordance with procedures as specified.
- (t) The Contractor shall submit the Construction Design and Drawings for a particular work to the Engineer at least 3 months but not more than 6 months prior to the planned / scheduled date of commencement of that particular work.

6.14.5 Design Changes

In the event that the Contractor identified a problem or other cause for a change in his design after the Construction Design has been submitted and consented by the issue of Notice of No Objection during the Construction Phase, the Contractor shall propose, in writing, the design change through a Field Change Notice (FCN) or a Design Change Notice (DCN). These Design changes shall go through the full process of the Design Review Procedure.

6.15 AS-BUILT DOCUMENTS

- 6.15.1 The Contractor shall maintain all records necessary for the preparation of the As-Built Documents. The Contractor shall prepare and submit the As-Built Drawings and the Records which shall become the contents of the As-Built Documents on Engineer's agreement. Within seven days of commissioning of any Sub-System, the Contractor shall submit 6 sets of verified design documents. Prior to the issue of the Taking-Over Certificate and in accordance with the Conditions of Contract Clause 5, the Contractor shall prepare the As-Built Drawings and Records which, subject to the Engineer's agreement, shall become the contents of the As-Built Documents.
- 6.15.2 The As-Built Drawings shall be a full set of the latest revisions of the Construction Technical Drawings, which are updated to incorporate all variation orders, Design Change Notices and Field Change Notices as well as Working Drawings as necessary to convey a full and true record of the as-built condition of the Works. The As-Built Drawings shall show all changes from the Preliminary/Final Detailed/Construction Designs and Drawings, all construction deviations and all other features relevant to the future maintenance and management of the Railway and its facilities.
- 6.15.3 The As-Built Drawings shall be endorsed by the Contractor as true records of the constructed Works.
- 6.15.4 The As-Built Records shall include the recorded photographs as being consistent to

Progress Reports in the Conditions of Contract.

- 6.15.5 The As-Built Records shall be verified and endorsed by the Contractor through the Internal Authorization Process, as specified in 'Quality Assurance' of this Employer's Requirements, as true records of the construction of the Works.
- 6.15.6 As part of the As Built Documents, the Contractor shall maintain all records necessary for the completion and commissioning of the project. These records shall consist of as a minimum but not limited to the following:
- (a) The list of implemented work according to activities, locations/ places;
 - (b) Used Material – type, Name of Material, name of manufacturers along with batch number, Date of Manufacturing, locations/ places and quantities etc.;
 - (c) Installation drawing complete with route, location plan, Mounting details and cross sections of Equipment & Components;
 - (d) 'Control' and 'Status' monitoring Cable index, control logics, schematics and wiring diagrams as applicable';
 - (e) Electrical and mechanical clearances including Clearance of track side equipment (e.g. OHE mast, Signals, Location Boxes etc.) in millimeters. from Centre line of adjacent track(s) shall be verified and painted on the relevant equipment;
 - (f) Any other record as required by the Engineer / Employer;
 - (g) Records related with acceptance of change orders and
 - (h) Construction Diary.
- 6.15.7 In addition to the Design Manual, the Contractor shall prepare and submit the Operation and Maintenance Manuals (O&M Manuals) as part of the As-Built Documents.
- 6.15.8 The O&M Manual shall include the details of each system, subsystem, equipment / components of the Work as essential along with performance benchmarks of reliability, availability and Maintainability. The Requirement for the Operation and Maintenance Manuals (O&M Manuals) is further detailed in the this GS under different section in accordance with the Specifications and in sufficient detail for the Employer to operate, maintain, dismantle, reassemble, adjust and repair the Works.
- 6.15.9 The As-Built Documents shall be submitted to the Engineer for consent and issue of a "Notice of No Objection".
- 6.15.10 All the As Built Drawings and Records shall be submitted prior to the commencement of the Trial Runs. If as a result of tests and trials the "As built Drawings" need to be revised, these shall be also carried out. The Work shall not be considered to be completed for the purposes of issue of "Taking over Certificate" until these documents and manuals have been submitted and accepted by the Engineer.

6.16 DESIGN INTERFACE WITH OTHER CONTRACTORS

6.16.1 Other Contractors

- (a) The Contractor shall fully coordinate the design of the Works with the design of the other Contractors and shall follow the interfacing requirements as detailed in 'Interface Matrix'.

- (b) Those Works, which are required to be executed by the Other Contractors, shall be fully coordinated and integrated and shall be provided throughout the Design development and the results shall be recorded and summarized in the Combined Service Drawings (CSD) and the Interface Drawings and Report on Other Contractors as part of the Detailed Design.

6.16.2 External Related Parties

- (1) The Contractor shall fully coordinate the design of the Works with all relevant bodies and entities, in particular government authorities, departments and regulatory bodies, public utility companies, Power Supply Authorities, Indian Railway, consultants and contractors of adjacent projects whether ongoing or planned, as advised by the Engineer. The Contractor shall identify all such related parties in his Interface Management Plan (IMP) and other relevant requirements detailed the Particular Specification to the Employer's Requirements.
- (2) Co-ordination with Indian Railways for DFCC's General arrangement of OHE layout and their proposed Design in respect of those in vicinity of the existing structures of Indian Railways shall also be required to get approval from Indian Railways through Employer in addition to the consent by the Engineer. The Contractor shall be required to submit one additional copy of all his GADs / span arrangement and Design of all such structures to the Engineer for onward submission to Indian Railways.

6.17 DESIGN SUBMISSION PROCEDURE

- 6.17.1 In the case of submissions subsequent to the Technical Design, the Design Data shall be in accordance with the Employer's Requirements and the Technical Design.
- 6.17.2 The Contractor shall submit to the Engineer all the Designs and relevant Design Data together with the Design Certificates, on or before the respective dates for submission shown on the Design Submission Program or the Works Program detailed in Chapter-4 of this document. In the event that a resubmission of Design / Design Data is required, such resubmission shall be made as soon as practicable after the receipt of the relevant statement of objections. All submissions of Design Data shall include the copies as stipulated in the Employer's Requirements.
- 6.17.3 Following receipt of a submission of Design and Design Data, the Engineer shall, within the period specified in Design Submission Program respond as per the procedure defined therein and issue "Notice of No Objection" or "Notice of No Objection with Comments" or "Notice of Objection with Comments" as the case may be. The Contractor shall comply with the requirements accordingly as specified therein.
- 6.17.4 The issue of a 'Notice of No Objection' in relation to any submission of Design shall be entirely without prejudice to the review of subsequent submissions of Design or to any subsequent request for a Contractor's Variation, and shall not bind the Engineer in any manner Dedicated whatsoever when deciding whether to accept or not to accept the issue.

6.18 DESIGN REVIEW PROCEDURES

- (a) The designs for all stages shall be submitted for review and consent to the

Engineer. The form and the procedures adopted in the Contract shall not release/remove/ exonerate the Contractor's responsibility towards the design under this contract.

- (b) The issue of a 'Notice of No Objection' will be without prejudice to the issue of any future Notices.
- (c) The Contractor shall, prior to the submission of the all the Design, obtain all required and /or statutory approvals that relate to that submission and demonstrate that all required approvals have been obtained.
- (d) Supplemental, supporting information to the design submission under review may be requested by the Engineer. The Contractor shall supply such information within the time specified by the Engineer.
- (e) All submissions shall be accompanied by six (6) original copies of "Design Certificate" format as per Appendix-3.

6.19 DOCUMENT & DRAWINGS SUBMISSION PROCEDURE

The Contractor's Technical Proposals shall be amplified during the design stages. The following process of document submission shall be generally followed:

- (a) The Contractor shall submit drawings and documents, as required by the Contract, to the Engineer in accordance with the Design Submission Program meeting the requirements.
- (b) The Construction Design submittals shall be made sufficiently before the Works are to be carried out to give the Engineer reasonable time to examine the drawings or other documents and to prepare comments within the response time.
- (c) Where the consent / Notice of No Objection from the Engineer is required, the Engineer shall notify the Contractor in writing of his decision within stipulated time of 28- days.
- (d) the Engineer has reasonable cause for being dissatisfied with the submissions made by the Contractor, the Engineer shall inform the Contractor in writing to make such amendments thereto as the Engineer may consider necessary. The Contractor shall make such amendments at no additional expense to the Employer and shall resubmit the amended documents for Engineer's consent.
- (e) Within 7 days of notification of the Engineer's consent / "Notice of No Objection" or "Notice of No Objection with Comments", the Contractor shall provide the Engineer with the type and numbers of sets of the relevant drawings and / or documents as stipulated in the Employer's Requirements for further execution of the process.
- (f) Should it be found at any time after notification of consent / "Notice of No Objection" / "Notice of No objection with Comments" (as the case may be) that the relevant drawings or documents do not comply with the Contract or do not agree with drawings or documents in relation to which the Engineer has previously notified his consent / "Notice of No Objection" / "Notice of No objection with Comments" (as the case may be), the Contractor shall, at his own expense, make such alterations or additions as, in the opinion of the

Engineer, are necessary to remedy such non-compliance or non-agreement and shall submit all such varied or amended drawings or documents for the consent of the Engineer.

- (g) Errors, omissions, ambiguities, inconsistencies, inadequacies and other defects shall be rectified by the Contractor at his own cost and the acceptance by the Engineer of the Manufacture and Construction Documents shall not amount to any waiver and shall not relieve the Contractor of his obligations under the Contract.
- (h) No examination by the Engineer of the drawings and / or documents submitted by the Contractor, nor any consent / "Notice of No Objection" / "Notice of No objection with Comments" (as the case may be) of the Engineer in relation to the same, with or without amendment, shall absolve the Contractor from any of his obligations under the Contract or any liability for or arising from such drawings or documents.

6.20 CALCULATIONS

- 6.20.1 The contractor shall submit all the drawings accompanied with Detailed report, calculations, supportive documents, references and evidences of previous examples where in such a method has been used.
- 6.20.2 All the required calculations shall be submitted together with the respective Design Package submissions unless stated otherwise.
- 6.20.3 A comprehensive set of calculations for the whole of the Design including that for simulation study in the form acceptable to the Engineer shall be submitted by the Contractor to the Engineer for consent as part of the relevant submittals.
- 6.20.4 Should the design of the Works be revised, the Contractor shall prepare and submit revised calculations as well as the revised designs and drawings and recall all previous versions circulated in past.
- 6.20.5 The Engineer shall require the Contractor to submit and install one copy of all the applicable software as used by the Contractor for the Design excluding the train and traction Power Simulation Computer Program, duly licensed in the name of Employer and the Engineer and in accordance with Employer's Requirements of this specification including in-house software program / worksheets developed by the Contractor, computer input and program logic prior to the acceptance of any computer output. The Contractor shall submit the same to the Engineer without any additional cost.
- 6.20.6 The Contractor shall submit all calculations necessary to support proposals relating to the construction methods.

6.21 CONTRACTOR'S WARRANTY OF DESIGN

- 6.21.1 The Contractor warrants that the Contractor's design shall be in accordance with General Obligations Conditions of Contract and meets the Employer's Requirements and Specifications provided by the Employer and is fit for the purpose thereof. Where there is any inadequacy, insufficiency, impracticality or unsuitability in or of the Employer's Requirements and Specification or any part thereof, the Contractor's design shall take into account, address or rectify such inadequacy, insufficiency, impracticality or unsuitability at Contractor's own cost.

- 6.21.2 The Contractor shall indemnify the Employer against any damage, expense, liability, loss or claim, which the Employer might incur, sustain or be subject to arising from any breach of the Contractor's design responsibility and /or warranty.
- 6.21.3 The Contractor further specifies and is deemed to have checked and accepted full responsibility for the Contractor's part of the design notwithstanding:
- (a) That such design may be or have been prepared, developed or issued by the Employer which has been checked by the Contractor, any of Contractor's consultants, his sub contractor's and/or his qualified personnel/persons or cause to be prepared, developed or issued by others.
 - (b) Any warranties, guaranties and /or may be or may have been submitted by any other person.
 - (c) That the same have been accepted by the Engineer.
- 6.21.4 The Contractor shall conform to the provision of any statute relating to the Works and regulation and bye-laws of any local authority and of any water and lighting agencies or undertakings, with whose system the work is proposed to be connected and shall before making any variation from the drawings or the specifications that may be necessitated by so confirming give to the Engineer notice specifying the variation proposed to be made and the reason for making the variation and shall not carry out such variation until he has received instructions from the Engineer in respect thereof. The Contractor shall be bound to give all notices required by statute, regulations or bye-laws as aforesaid and shall pay all fees and taxes payable to any authority in respect thereof. Nothing shall be payable by the Employer in this regard.
- 6.21.5 The Contractor shall ensure compliance of provision of all laws of land in force and enacted from time to time and ensure compliance of the regulations or bye-laws of any local body and utilities. The ignorance of rules, regulations and bye-laws shall not constitute a basis for any claim at any stage of work. The Contractor shall arrange necessary clearances and approvals before the work is taken up.
- 6.21.6 The Design Warranty shall be submitted by the Contractor in format provided at Chapter 15: Annexure 3 – Design Certificate.

(End of Chapter-6)

CHAPTER-7 WORK AREA MANAGEMENT

7.1 WORKS AREA

- 7.1.1 The Contractor shall divide the Site into separate Works Areas/Railway Envelopes and shall elaborate a schedule for the time periods of the availability of these areas for his contract performance. This should be synchronized with the Schedule of access to Site provided in Appendix to Tender – Part 3 of the Bidding documents taking account of the Contractor's co-ordination and integration responsibilities with the interfacing contractors.
- 7.1.2 The Contractor shall indicate the exact nature of the various Works Areas and the extent of works to be carried out prior to the execution of the permanent systems works or making use of the area as working space and/or for temporary Site facilities.
- 7.1.3 The schedule as mentioned above shall include, but not limited to, the following data:
- (1) Indication of the Works Areas;
 - (2) Description and intended use of the Works Areas;
 - (3) The start and the end date of the availability of the Works Areas, required by the Contractor;
 - (4) The start and the end date of the periods in which the Contractor is to allow the Works Areas to be accessed by interfacing parties.
- 7.1.4 The information shall be submitted as part of the Contractor's preliminary design and shall be subject to agreement by the Employer and approval by the Engineer.
- 7.1.5 On the basis of the approved information, the Contractor shall submit the proposal for the use and the occupation of the Works Areas, such submissions being at least fifty six (56) days prior to the program use of the specific Works Area.
- 7.1.6 Prior to the scheduled dates for returning of any of the Works Areas for subsequent use by an interfacing party, the Contractor shall carry out the following activities:
- (1) Construct all Permanent Works within the Works Area, to the extent as defined in the Detailed Design and in accordance with the requirements of the Contract;
 - (2) Reinstate the area to the same condition as it was taken over;
 - (3) Form the area to the approved lines and levels and carry out such other works as may be required by the provisions of the Contract;
 - (4) Remove all rubbish, debris and other material; and
 - (5) Carry out and record jointly with the Engineer and interfacing contractors a condition survey of the area.
- 7.1.7 Restrictions on the timing of occupation so as to avoid affecting operation will be made.
- 7.1.8 The interfacing parties shall be required to vacate the Works Areas at least 56 days before the due date for handing over back of the Works Areas by the Contractor to the Employer, thus allowing the Contractor to clear and reinstate the works areas in accordance with the Contract.
- 7.1.9 Entry to and exit from the Site shall be controlled and shall be only available at the locations for which the Engineer has given his consent.

- 7.1.10 The Contractor shall ensure that access to every portion of the Site is continually available to the Employer and Engineer.
- 7.1.11 Other contractors engaged for project execution shall also be allowed to use the temporary facilities so created by him to access the Site without any consideration.
- 7.1.12 Employer will take over the entire stretch as per General Conditions of Contract.
- 7.1.13 The Contractor shall be responsible for ensuring that any access or egress through the Site boundaries are controlled such that no disturbance to residents or damage to public or private property takes place as a result of use of such access or egress by its employees and sub-contractors.

7.2 STANDARD ENGINEERING CONDITIONS

The following standard engineering conditions apply to all Works Areas:

7.2.1 Forming of Areas

- (1) The Works Areas shall be formed to the levels shown on the drawings.
- (2) No levels shall be amended without prior consent of the Engineer.
- (3) The Works Areas shall be surfaced in a manner agreed with the Engineer, compatible with their intended use and in particular, footpaths and roadways connecting facilities shall be provided.
- (4) Measures shall be taken to the satisfaction of the Engineer to ensure all areas are properly drained and kept free of static water.

7.2.2 Roads and Parking

- (1) Space shall be provided within the Works Areas for parking, loading/unloading and maneuvering of motor vehicles.
- (2) Any damage caused by the Contractor to the adjoining public roads and fixtures and properties (public or private) shall be made good to the satisfaction of the Engineer and its owner.
- (3) In case the management of traffic around the worksite becomes necessary, the contractor shall carry out the same at his own cost. The Engineer however, may at times request the contractor to leave the temporary diversion of the road in place. All such requests by the Engineer shall be entertained by the contractor.

7.2.3 Drainage and Sewerage

- (1) All storm or rainwater from the Work Areas including any access roads thereto shall be carried to the nearest stream course, which has the necessary capacity, catch-pit, and channel or storm water.
- (2) All temporary and permanent Works shall be carried out in such a manner that no damage or nuisance are caused by storm water or rain water to the Site and adjacent property.
- (3) Damage or obstruction caused to any watercourse, drain, main or other water installations within or adjoining the Works Areas shall be made good to the satisfaction of the Engineer.
- (4) Treatment and disposal of sewage and wastewater from the Works Area shall be

provided to the satisfaction of the Engineer following the ecological requirements.

7.2.4 Buildings

- (1) No permanent structures other than those required for the Permanent Works shall be permitted in the Works Areas.
- (2) The Contractor, as required, for all temporary buildings, shall provide requisite electricity, water, telephones and sewerage facilities.

7.2.5 Pedestrian Access

Any accesses or passing through the Works Areas shall be maintained in a usable condition at all times to the satisfaction of the Engineer including lighting, signing and guarding.

7.2.6 Fencing and Signboards

For executing the work adjacent to running traffic areas, the Contractor shall erect fences and gates around its areas of operations to prevent accidents as well as post competent flagmen.

7.3 POSSESSION OF IR TRACKS

7.3.1 General

- (1) The Contractor shall comply with the traffic block (Possession) management system operated by Indian Railways (IR).
- (2) The person appointed by Contractor shall coordinate with IR and the CST Contractor and shall act as the traffic block coordinator for the Contractor.
- (3) The person appointed must have experience of IR operations and must be fully aware of IR rules and regulations related to possession of track for construction of railway works in accordance with IR regulations including meeting the Competency requirements as stipulated by IR.
- (4) While working in close proximity of existing IR track, the contractor shall obtain permission for works with or without traffic block from the concerned Railway Authority/interfacing agencies, wherever applicable and DFCC shall assist in obtaining such permit(s). Extra precautions to be observed by the contractor while working in close proximity of existing Indian Railway track.

7.3.2 Power Block

Cost of Power & Traffic Block if any shall be borne by DFCC. However, if any penalty becomes livable on account of late cancellation of Block or otherwise due to any other reasons, shall be payable by the contractor.

7.4 POSSESSION PERIODS

- (1) The Contractor may use possession(s) on the line for execution of works as per approved plan following strict safety procedures.
- (2) Line closures may be agreed subject to IR approval.
- (3) The Employer gives no warranty that line closures and possession periods will be available during the period of the Works.

- (4) The Employer will however provide any assistance necessary to the Contractor to enable him to obtain the line closures and possessions required by him for the Works but will not be responsible if any Possession requests are refused by IR.
- (5) The Contractor shall prepare technological and organizational schedule for construction which shall include the work times in the weekends and during the dark part of the day.
- (6) The Contractor shall submit his requests for 'possessions' at least fourteen (14) days earlier and inform IR at least 48 hours earlier if he is not able to use the permitted 'possessions'.

7.5 TEMPORARY WORKS

The Temporary works are detailed in Appendix 4, Chapter 15

7.6 REQUIREMENT FOR CONSTRUCTION

The Requirements for Construction are detailed in Appendix-5, Chapter 15

(End of Chapter-7)

CHAPTER-8: MANUFACTURING, SUPPLY, INSTALLATION, TESTING & COMMISSIONING

8.1 GENERAL

- 8.1.1 These Employer's Requirements establish the overall procedure for the Contractor to follow for the Works that is related to the components manufactured off-site and supplied for installation in the Permanent Works. These requirements relate to their manufacturing, procurement, delivery, testing and installation in the system and associated activities.
- 8.1.2 The Contractor shall establish procedures and controls that govern the procurement/manufacturing off-site of material/equipment/ components required for the work and supply them for construction/installation, assembling and wiring in the Permanent Works.
- 8.1.3 The Contractor shall submit comprehensive Testing Plan & Testing Program for the project to the Engineer for his consent.
- 8.1.4 Type Test shall be performed by the Contractor and shall be witnessed by Employer and Employer's Personnel / Engineer.
- 8.1.5 Factory Acceptance Test shall be performed by the Contractor and shall be witnessed by Employer's Personnel / Engineer.
- 8.1.6 Approval for witnessing Type Test and Factory Acceptance Tests shall be communicated by the Engineer to the Contractor after obtaining consent from the Employer.
- 8.1.7 The material delivered to the Site and offered for Inspection shall be manufactured normally not earlier than one (1) year and their guarantee period shall cover the Defects Notification Period. However the specified period of Manufacturer's Warranty shall commence from the date of commissioning of the Work and all the manufacturer's Warranties shall be in the name of the Employer.
- 8.1.8 All material shall be as per the Specifications furnished and as consented by the Engineer.
- 8.1.9 Manufacturing and testing of various equipment, components, fittings, clamps, jumpers, cables, droppers and other material shall be as per relevant Employer's Specifications.

8.2 MANUFACTURING

8.2.1 Management

The Contractor shall establish procedures and controls that govern the procurement, integration, manufacturing and testing, quality assurance and delivery of plant & equipment, manufactured items and spares to be supplied under the Contract. The Contractor shall submit Procurement Management & Manufacturing Plan and Quality Assurance Plan to the Engineer for his consent.

8.2.2 Procurement and Subcontract Management

The Contractor's Management Systems and Procedures shall incorporate procedures for material procurement and sub-contracting, sufficient to assure technical, administrative,

quality and contractual controls consistent with those under this contract. The Contractor's management system shall be auditable for material sources, lot numbers, serialized equipment, etc. Sub-contract amendments shall be effected whenever contractual changes are made bi-laterally by the parties involved subject to consent of the Engineer.

8.2.3 Manufacturing Management

The Contractor's Quality Assurance Plan to control the Manufacturing quality shall contain:

- (1) A brief description of all inspection & Hold points and test points in correlation with the Program Schedule;
- (2) A list of all manufacturers, and sub-contractors for supply.
- (3) A delivery schedule of each item of equipment to match coordinated installation plan.

8.2.4 Testing

A comprehensive Testing Program submitted by the Contractor shall include complete equipment, their subsystems and components and material to ensure conformance with the specifications. The Testing Program shall be subject to the consent of the Engineer. The purpose of the comprehensive Testing Program shall be to:

- (1) Substantiate design and performance characteristics;
- (2) Ensure operational compatibility;
- (3) Complete equipment verification and acceptance requirements; and
- (4) Complete all reliability, maintainability and safety demonstration requirements.

Testing shall comply with the requirements as specified in this Employer's Requirements.

8.2.5 Quality Assurance And Controls

8.2.5.1 The Contractor's management systems shall emphasize quality assurance and controls and shall be based on ISO 9001-2008 standards. The Procurement, supply and manufacturing and Quality Assurance Plan together with the Comprehensive Testing Program shall adequately ensure an acceptable level of quality of the Items manufactured and supplied. The concept of total quality assurance shall be based on the principle that quality is a basic responsibility of the Contractor's organization shall be evidenced by:

- (a) Producable and verifiable designs;
- (b) Firm procurement and job performance specifications;
- (c) Firm procedures for transmission of information and data to sub-contractors and ensuring their compliance;
- (d) Adequate testing to ensure repetitive product conformity to design requirements; and
- (e) Total Program of surveillance and verification of physical performance and configuration accountability.

8.2.5.2 The Contractor shall maintain records to demonstrate evidence of quality and

accountability. These records shall include results of inspections, tests, process controls, certification of processes and personnel, discrepant material and other quality control requirements.

- 8.2.5.3 Inspecting and testing records shall be in ISO format and as a minimum, indicate the nature of the observations made, the number & types of deficiencies found and action proposed to correct deficiencies. Also, records for monitoring work performance and for inspecting and testing shall indicate action taken for the correction of deficiencies.
- 8.2.5.4 The Contractor shall submit to the Engineer a request for a "Notice of No Objection to Supply" for the manufactured items along with all the relevant manufacturer's test certificates and inspection certificates prior to shipping / transporting.

8.3 PACKAGING, TRANSPORTATION AND STORAGE OF PLANT AND MATERIAL

8.3.1 Packaging and Shipping

- (1) The packaging and shipping shall be done keeping in mind that the equipment and cables do not get damaged during transit. The Contractor's quality control personnel shall verify the inspection and preparation for shipment.
- (2) Each case, crate or package shall be of robust construction and suitable for the intended purpose. Packaging material that are likely to suffer deterioration in quality as a result of exposure to environmental conditions likely to be met during transit from the factory of origin to the Site shall not be used.
- (3) The contents of each case, crate or package shall be protected against the harmful effects of ingress of moisture / water by enclosing within a heavy duty waterproof membrane.
- (4) Each case, crate or package shall be legibly and indelibly marked in large letters with the address, Contract number, 'right way up', opening points and other markings like "fragile", "keep dry", "handle with care" etc. along with visual display of internationally accepted symbols as necessary to permit material to be readily identified and handled during transit and when received at Site.
- (5) Each case, crate or package shall contain a comprehensive packing list showing the number, mark, size, weight and contents together with any relevant drawings. A second copy of the packing list shall be enclosed in a watertight enclosure on the outside of each case, crate or package. Distribution of additional copies of each packing list shall be in accordance with the requirements of the Engineer.
- (6) All items shall be marked on the outside of the case to show the gross and net weights, the points for slinging and where the weight is bearing.
- (7) Care shall be taken to prevent movement of equipment within containers by the provision of bracing, straps and securing bolts as necessary.
- (8) Bags of loose items shall be packed in cases and shall be clearly identified by well-secured metal labels on which the quantity and name of the part and its index or catalogue number have been stamped.
- (9) Details of cases, crates, packages, containers, etc., intended to hold important or delicate items of equipment or material shall be submitted to the Engineer for acceptance.

8.3. 2 Handling, Storage and Delivery

- (1) The Contractor shall provide Comprehensive Test and inspection instructions for handling, shipping, storage, preserving, packaging, packing, marking, and shipping to protect the quality of the equipment and to prevent damage, loss, deterioration, degradation or substitution thereof.
- (2) Handling procedures shall include the use of special crates, boxes, containers, transportation vehicles, equipment and facilities for material handling.
- (3) Unless otherwise consented by the Engineer, the Contractor shall provide adequate and covered storage facilities for storing in a safe and secure manner all the plant & equipment and manufactured items to be supplied and erected as part of the Contract.
- (4) The Contractor shall make its own arrangement of space for storage facility. However, if the spare land is available with the Employer, the same will be handed over to the Contractor free of cost, for the purpose of establishing temporary construction depot(s) with the condition that whenever the Employer requires this portion of land back, the same shall be handed over by the contractor at a month's notice at no extra cost/compensation to the Contractor.
- (5) Means shall be provided by the Contractor for protection against deterioration or damage to equipment in storage. Where shelf-life of the equipment / material is limited, this shall be clearly stated on the shipment. Secure compound and storage for the high value items shall be integral part of the safe storage. Spares to be supplied shall also be kept safe and secure until handed over to the Employer at the time of Commissioning.
- (6) The Contractor shall deliver all items supplied under this Contract to the Site as desired by the Engineer.
- (7) The Contractor shall include the delivery activities in his Monthly Schedule Updates that he would submit to the Engineer in accordance with provisions of Chapter 3 of this GS.
- (8) The Contractor shall ensure the Site is ready and in good conditions for delivery.
- (9) The Contractor shall ensure good conditions and security of the delivered items on Site.
- (10) The Contractor shall remove temporary fittings, if necessary, for delivery of his items to site and shall restore the fittings to the original state and to the satisfaction of the Engineer.
- (11) No dangerous goods shall be delivered to the Site.

8.3. 3 General Precautions

- (1) Spare parts shall be suitably packed for storage over an indefinite period without deterioration and shall be clearly identified showing full name and part number without any need to unwrap packaging. Electrical and other delicate items or equipment shall be cocooned.
- (2) Cable ends, cable entry points into equipment and other similar terminations and openings shall be sealed or blanked off to prevent the ingress of dirt, vermin or moisture.

- (3) Tube ends and other similar openings shall be thoroughly cleaned and then blanked-off to prevent ingress of dirt or moisture.
- (4) Flanged ends shall be protected by adhesive tape or jointing material covered by a properly secured wooden blank not smaller than the flange itself.
- (5) Particular care shall be taken to prevent damage to or corrosion of shafts and journals, where they rest on timber or other supports that may contain moisture.
- (6) At such points wrappings impregnated with anti-rusting compositions shall be used, of sufficient strength to resist chafing under the pressures and movements likely to occur in transit.
- (7) Care shall be taken to minimize risk of damage to ball and roller bearings and any fragile material in transit.

8.3. 4 Specific Requirements

(1) Handling and Storage of Power and Control Cables

- a. Immediately after the tests at the place of manufacturing, both ends of every length of cables shall be sealed & secured by heat shrinkable caps, to prevent ingress of moisture.
- b. The ends of the factory lengths of cable shall be marked "A" and "Z", "A" being the end at which the sequence of core numbers is clockwise and "Z" the end at which the sequence is anti-clockwise (The words "Running End 'A'" or "Running End 'Z'" as appropriate shall be marked on the flange and the direction for rolling shall be indicated by an arrow).
- c. The end which is left projecting from the drum shall be consistently "A" or "Z", and shall be protected against damage in such a manner that the enclosure cannot be easily removed during handling while in transit.
- d. Cables shall be supplied on drums in the longest possible lengths which are practicable. .
- e. The maximum allowable diameter of cable drums for the Signalling and OFC cables should be 2000 mm. The use of cable drums with diameter in excess of 2000 mm shall be subjected to the review of the Engineer.
- f. All drums shall also be designed for use in conjunction with any special cable-laying equipment and accessories complete with spindles and cable drum braking gear, which shall be used to install the cables on Site.
- g. Particulars of the cable, i.e. voltage, length, conductor size, number of cores, finish, section and length number, gross and net weights, shall be clearly shown on one flange of the drum.
- h. An arrow showing direction of rolling shall be shown. Both ends of the cables shall have heat shrinkable caps. The caps shall incorporate sealants which melt on heating at temperatures well above outdoor ambient expected in DFCC area.

(2) Sub-Assemblies

All components shall be packed together and properly labelled and numbered.

Diagrams to ensure that they are properly assembled at site in the required order of components shall also accompany the packaging.

8.4 INSTALLATION

- 8.4.1 The Contractor shall carry out site surveys to ensure sufficient knowledge of the Site before submitting the relevant installation drawings and installation related submissions to the Engineer for review.
- 8.4.2 The Contractor shall provide all necessary and sufficient resources such as tools, test instruments, spares, and equipment, manpower and communication facilities to complete all the installation activities.
- 8.4.3 The Contractor shall ensure that all Installation works are supervised and technical, safety and quality matters adhere to the Design as reviewed by the Engineer.
- 8.4.4 The Contractor shall take every precaution to protect existing equipment and facilities on Site from damage and shall make good any damage caused. Care shall also be taken not to interfere with the operation of existing equipment(s).
- 8.4.5 The Contractor shall submit installation method statements for each type of installation activities at least three months before the commencement of the activity to the Engineer for review.
- 8.4.6 The installation method statement shall include the details on the methods and procedures of installation, site arrangement, manpower resources, equipment and tools required. Drawings shall be included to illustrate the proposed installation details.
- 8.4.7 During installation, care may be taken to ensure that the manufacturer's erection instructions are correctly followed.
- 8.4.8 The installation for major items such as important components and vital equipment shall be undertaken preferably in the presence of the manufacturer's field service representative.
- 8.4.9 The Contractor shall make certain that the installation of all supports, gaskets, hardware, etc., are accomplished so as to assure safe, accurate and trouble-free installation.
- 8.4.10 All installation activities shall commence only after the method statement and related submissions have been reviewed without objection by the Engineer.
- 8.4.11 The Contractor shall ensure that his staff are competent and possess all the necessary skills to carry out the installation in a proper and safe manner.
- 8.4.12 The Contractor shall assign competent site supervisors for each work site to be responsible for all site-related matters.
- 8.4.13 The Contractor shall carry out regular site audit on both technical and safety matters and maintain records of the site audits. The Contractor shall make these records available to the Engineer for inspection upon request.
- 8.4.14 All the equipment shall be installed in accordance with OEM's installation checklist. A certificate shall also be required to be issued that the installation has been done in accordance with the Installation checklist and Earthing and surge protection arrangements are in accordance with latest RDSO specification. The equipment shall not be commissioned unless such a certificate has been issued.

8.5 INSTALLATION METHOD STATEMENT

- 8.5.1 Installation Method Statements which is part of the Construction/Installation Method Statement shall be submitted to the Engineer for review at least 28 days prior to the installation activity commencing on site.
- 8.5.2 Prior to proceeding with installation, the Contractor shall submit, for the Engineer's consent, six copies of drawings showing all installations including dimensions, supports, hardware, installation methods and documents confirming the availability and location of special installation tools and equipment and all other pertinent data.
- 8.5.3 The manufacturer's erection instructions shall be carefully followed.
- 8.5.4 The Contractor shall make certain that the installation of all supports, gaskets, hardware, etc., are accomplished so as to assure safe, accurate and trouble-free installation. The installation for major items such as important components and vital equipment such as Traction and Auto transformers shall be undertaken preferably in the presence of the manufacturer's field service representative.
- 8.5.5 Upon noticing or being advised of any inconsistencies between the installation drawings and documentation and the installed equipment, the Contractor shall notify his acknowledgement to the Engineer and correct such errors within two weeks.
- 8.5.6 Equipment that is improperly installed shall be removed, checked / tested and reinstalled. Any damage caused due to improper installation and removal shall be rectified before reinstallation at no extra cost to the Employer.

8.6 MATERIALS AND WORKMANSHIP

- 8.6.1 Materials utilized in the Works shall be free from defects, shall be new, recently manufactured and of a classification and grade in full conformity with the Contract.
- 8.6.2 Products and equipment shall be approved only when the Engineer has been satisfied as to their strength, reliability and suitability as per application duty requirement. To assist the Engineer in this respect, the Contractor shall furnish on request, performance data, references to completed works and any other relevant information together with samples of materials for approval. Materials and any other articles adopted without the approval of the Engineer shall be rejected. The Works shall be constructed in accordance with the Good Industry Practice and shall comply with all local regulations and codes of practice which apply to such Works.

8.7 INSTALLATION MATERIAL

- 8.7.1 The Material used for Installation as Permanent Works shall be new, rust free and complies with the relevant specifications.
- 8.7.2 Certificates of tests by manufacturers which are to be submitted to the Engineer shall be current and shall relate to the batch of material delivered to the Site.
- 8.7.3 True copies of certificates, duly certified by the manufacturer and the Contractor may be submitted if the original certificates could not be obtained from the manufacturer.
- 8.7.4 Parts of material which are to be assembled on the Site shall be marked to identify the different parts.

- 8.7.5 Material which are specified by means of trade or proprietary names may be substituted by material from a different manufacturer which has received the consent of the Engineer provided that the material are of the same or better quality and comply with the specified requirements.
- 8.7.6 Samples of material submitted to the Engineer for information or consent shall be kept on the Site and shall not be returned to the Contractor or used in the Permanent Works unless permitted by the Engineer.
- 8.7.7 The samples shall be used as a means of comparison which the Engineer shall use to determine the quality of the material subsequently delivered. Material delivered to the Site for use in the Permanent Works shall be of the same or better quality as the samples which have received consent.
- 8.7.8 All the surplus serviceable material, if not required by the Employer, and unserviceable material shall be carried away from the Site by the Contractor and disposed off in the manner consented by the Engineer.

8. 8 SAMPLES

- 8.8.1 In addition to any special provisions in the Contract for the sampling and testing of materials, the Contractor shall submit, in response to the request of the Engineer, samples of any materials or fittings which the Contractor proposes to use in the Works.
- 8.8.2 Such samples, if reviewed without objection, shall be retained by the Engineer for the duration of the Contract and no materials or goods of which samples have been submitted shall be used in the Works unless and until such samples shall have been reviewed without objection by the Engineer.
- 8.8.3 The Engineer may reject any materials and goods, which in its opinion are inferior to the samples previously approved and the Contractor shall promptly remove such materials/goods from Site.

8. 9 MOCK-UPS

The Contractor shall construct mock-ups, if required, to demonstrate to the satisfaction of Engineer that the designs of the elements of the System will fulfill the requirements of the Contract.

8. 10 DISPOSAL OF SURPLUS MATERIAL

The disposal of surplus or waste material, debris of demolished existing structures or buildings and unsuitable material etc. shall be the responsibility of the Contractor and this material shall be treated and disposed of by the Contractor at an approved location(s) at his own cost. The disposal plan and program shall be subject to approval by the Engineer.

8. 11 ASSET IDENTIFICATION

- 8.11.1 The Contractor shall submit for review by the Engineer an asset Information database as below but not limited to:
- (a) Asset Description;

- (b) Rating/ size details
- (c) Date Manufactured, Batch no.
- (d) Date of Installation
- (e) Testing log with date and results.
- (f) Failure History

8.11.2 All equipment and software shall have a unique identification number that can be identified electronically and manually.

8. 12 TESTING & COMMISSIONING

8.12.1 The Contractor shall provide and perform all forms of Inspection and testing procedures applicable to the Works relating to plant & equipment and manufactured items and various components and the interfacing of the Works relating to plant & equipment and manufactured items with the other contractor(s) and shall conduct all necessary factory, site & acceptance tests.

8.12.2 The commissioning activity shall include a period of the Integrated System testing followed by a period of Trial Run.

8.12.3 Within 180 days from the date of Commencement of the Work, the Contractor shall submit a comprehensive Testing Program defining the personnel, procedure and format of testing.

8.12.4 All testing procedures shall be submitted at least 56 days prior to conducting any Test. The testing procedures shall show unambiguously the extent of testing covered by each submission, the method of testing, the acceptance criteria, the relevant drawing (or modification) status and the location.

8.12.5 The testing procedures shall be submitted by the Contractor and amended subsequently, if required, by the Contractor during the duration of the contract to reflect changes in design of works, interface systems or the identification of additional testing requirements, if needed.

8.12.6 The contractor shall facilitate the Employer's Personnel/ the Engineer to inspect the works and monitor all tests and have access to all testing records.

8.12.7 Sufficient time shall be allowed within the Testing Programs for necessary alterations to equipment, sub-systems and designs to be undertaken, together with re-testing prior to final commissioning.

8.12.8 The Contractor shall keep in mind that at some point of time, the electric Traction System shall be energized and the additional precautions for the safety and co-ordination of the activities prior to and after 'power-on' shall be anticipated in his co-ordination with other contractors and installation, testing and commissioning Programs of all the contractors and all associated with the Traction Power Energisation Program.

8.12.9 All costs associated with the testing shall be borne by the Contractor including the services of any specialized personnel or independent assessors. The Contractor shall also bear any expense incurred due to retesting caused by defects or failure of equipment to meet the requirements of the Contract in the first instance. This will however not include allowances for hotel and travel expenses for the persons witnessing/certifying the tests on behalf of the Engineer/Employer representative.

- 8.12.10 The Contractor shall provide and perform all types of tests applicable to the Works as stipulated in this GS and the PS.
- 8.12.11 The Contractor shall submit Test Plan(s) for approval by the Engineer and shall demonstrate that the tests are sufficient and adequate to meet the requirements of this Contract. This will include the EMC and EMI tests.
- 8.12.12 The witnessing of any Test by the Employer's personnel / Engineer shall not relieve the Contractor from his obligations, responsibilities and liabilities to complete the Works in accordance with the Contract nor relieve him of any of his obligations, responsibilities and liabilities under the Contract.
- 8.12.13 In the event of any test being performed in the countries other than India, the Contractor shall give at least 56 days' notice to the Engineer for witnessing the test.
- 8.12.14 If test reports are not acceptable as proposed due to absence of approved Test plan and procedures and/or Reports, failure to fulfill the pass/fail criteria, negligence, lack of preparation or unacceptable material and/or equipment, all costs incurred by the Employer's Personnel, the Engineer or any other personnel nominated by the Employer for repeated inspection and/or witness shall be borne by the Contractor.
- 8.12.15 All testing equipment shall be pre-checked for calibration accuracy by third party as acceptable to the Engineer.
- 8.12.16 The Engineer/ Employer's personnel shall sign all test reports of the test witnessed by him.

8. 13 TESTING PHILOSOPHY

- 8.13.1 Testing of various items shall be carried out as per testing procedures approved by the Engineer.
- 8.13.2 Unless otherwise agreed, all tests shall be witnessed by authorized representative of the Engineer & recorded. An appropriate format for Test Schedule(s) and Procedure(s) including the details of testing equipment shall be submitted to the Engineer for approval.
- 8.13.3 All tools & instruments for carrying out the tests shall be arranged by the Contractor to the satisfaction of the Engineer. Test results will be witnessed and signed by the Contractor and the Engineer.
- 8.13.4 Prior to shipment of equipment, the Employer's Personnel reserves the right to witness the testing of the equipment at the manufacturers' works.

8. 14 TEST CERTIFICATES AND REPORTS

The sequence of tests shall comprise as appropriate the following:

- (1) Type Tests, as and when required;
- (2) Routine Test carried out before offering for FAT,
- (3) Factory Acceptance Tests (FAT);
- (4) Installation Tests;
- (5) System / Sub-system Acceptance Tests (SAT);
- (6) Integrated Testing & Commissioning; and

(7) Trial Run.

8.15 TYPE TEST

- 8.15.1 Type tests shall be carried out on specific items to ensure that they perform their intended functions when subjected to all permutations and combinations of external environment and other factors. These items shall be subjected to prototype testing as per relevant Specifications.
- 8.15.2 In addition to the above, Type tests may also be performed for subsystems, components and items of equipment installed in the overall system in substantial numbers.
- 8.15.3 Type Test Reports and Certificates shall explicitly state the mandatory contents of the routine test Program and the individual inspection and measurement procedures that need to be performed on each individual item of identical series production devices or components.

8.16 FACTORY ACCEPTANCE TEST (FAT)

- 8.16.1 The Contractor shall conduct Factory Acceptance Tests (FAT i.e. all Type/Routine/acceptance/special tests) as specified in relevant standards & specifications at the premises of Original Equipment Manufacturer.as needed before dispatch of material.
- 8.16.2 All material, components, sub-assemblies, unit assemblies (including software, cables and wiring) shall be subjected to test and certification. FAT procedure shall be submitted for review by the Engineer Twenty Eight (28) days in advance of carrying out any Test.
- 8.16.3 The FAT shall demonstrate that each equipment /sub-system meets its functional specifications.
- 8.16.4 No equipment or software shall be delivered to the Site until the Contractor has demonstrated, to the satisfaction of the Engineer that the equipment or software conforms to the specifications by carrying out the FAT.
- 8.16.5 Where processor based equipment is to be used, the FAT shall also include verification of software used in this application.

8.17 INSTALLATION TESTS

8.17.1 Prerequisites for Installation:

Prior to installation, the Contractor shall ensure that equipment delivered to Site has not been damaged in transit and ensure for their dimensional accuracy.

8.17.2 Inspection:

- (a) During the inspection, it shall be verified that
- (i) The equipment has been installed as per the procedures & design that have been reviewed without objection by the Engineer and that equipment is correctly located and labeled.
 - (ii) Any false feed, temporary wiring and redundant items have been removed and that equipment is correctly protected against interference, damage and deterioration.

- (b) The Contractor shall maintain inspection records to demonstrate that each item of equipment has been inspected and found to be satisfactory and attach to this record a detailed list of any discrepancies found and remedial action taken.
- (c) As defects are rectified, these shall be recorded on the appropriate inspection record.

8. 18 POST-INSTALLATION TESTS

- (a) After installation of the equipment, visual inspection and operational tests on un-energized equipment shall be carried out to check the following:
 - (i) Cleanliness;
 - (ii) Workmanship;
 - (iii) Confirmation of items conforming to ratings specified;
 - (iv) Water and dust proofing;
 - (v) Leveling, mounting and positioning;
 - (vi) Joints and connections tightness;
 - (vii) Cables – dressing, bending radii, jointing and finish at terminals;
 - (viii) Clearances and dimensions in conformity with drawings;
 - (ix) Earthing and bonding;
 - (x) Functioning of circuit breakers, isolating switches and their interlocks;
 - (xi) Protection devices;
 - (xii) Phase sequence verification;
 - (xiii) Conformance to As Built Records.
- (b) During and on completion of installation, the Contractor shall undertake testing of all cables, wiring and equipment, instrumentation and protection devices including relays in a progressive sequence and in accordance with the overall-testing Programs.
- (c) The Contractor shall carry out installation tests for each sub-system following Installation but before SAT to demonstrate that the installation has been carried out correctly and equipment is properly housed and fixed.
- (d) These tests shall culminate in SAT to verify the correct operation of all apparatus and where appropriate, correct response to the respective control commands or monitored function.

8. 19 SYSTEM ACCEPTANCE TESTS (SAT)

8.19.1 The Contractor shall prepare and organize a comprehensive Program of Tests to demonstrate to the Engineer that all systems, sub-systems and apparatus defined under the Contract, when installed, connected and configured as a complete system meet the specified performance requirements in all respects.

8.19.2 Prerequisites and requirements for SAT to be satisfied before the commencement of the

System Acceptance Tests (SAT) shall be as follows:

- a. All documentation for the system safety report shall be submitted to the Engineer for review;
- b. All Installation Tests shall be completed and test records submitted to the Engineer;
- c. Facilities for the maintenance of the system shall be in place; and
- d. The SAT Plan shall be submitted to the Engineer for review.

8. 20 SAMPLES FOR TESTING

8.20.1 Samples that have been tested may be utilized in the Works provided that:

- a. The sample complies with the specified requirements;
- b. The sample is not damaged;
- c. The sample is not required to be retained under any other provision of the Contract; and
- d. Consent of the Engineer has been obtained, in writing.

8.20.2 Additional samples shall be provided for testing, if in the opinion of the Engineer:

- a. Material previously tested no longer complies with the specified requirements;
or
- b. Material has been handled or stored in such a manner that it may not comply with the specified requirements.

8.20.3 Unless agreed otherwise, all Tests shall be offered by the Contractor to witness by the Engineer.

8.20.4 Tests witnessing including that by Engineer / Employer, and the Contractor shall be as laid down in the Quality Assurance procedures.

8. 21 INTEGRATED TESTING

8.21.1 Integrated Testing on Completion shall include the Work of other contractor(s). The Contractor shall, following satisfactory completion of tests on his works, equipment, sub-systems or system, perform, at the direction of the Engineer, Program of tests to verify and confirm the compatibility and complete performance of his works, equipment, sub-systems or system with the works, equipment, sub-systems or system provided by others.

8.21.2 The Contractor shall submit to the Engineer the requirements and procedures in respect of the Contractor's scope of work for Integrated System Tests in conjunction with the other contractors to demonstrate that the complete system provided under the Contract is fully operational and meets the specified performance criteria.

8.21.3 Integrated Testing & Commissioning refers to those tests undertaken in order to demonstrate that the various components of the railway systems operate satisfactorily between one another and meet all specified requirements for design, operability, safety, and integration with other systems.

8.21.4 These tests shall be entirely within the requirements of one or more of the Project Contracts or they shall involve a multiplicity of Contract procedure. The final Integrated Testing and Commissioning shall be carried out after the SCADA system and OCC have become operational.

8.21.5 Those systems that can be tested without depending on the running of trains, such as SCADA and Telecom system etc., will have their integration tests scheduled to commence as early as possible. It is preferable that any interface problem associated with these "train less" system tests be identified and resolved prior to the commencement of test running.

8.21.6 The Integrated Tests by the Contractor and other contractors shall include a period of Trial Run.

8. 22 COMPLETION OF TEST RESULTS

The results of the Integrated Testing and Commissioning shall be compiled and evaluated by the Engineer and the Contractor.

8. 23 FAILURE TO PASS TEST

If the Works, or a part thereof, or a Section, or a plant & equipment and manufactured item fail to pass Integrated Testing and Commissioning and the Contractor in consequence proposes to make any adjustment or modification to the Works or a part thereof, or a section, or the plant & equipment and manufactured item, the Engineer may, with the approval of the Employer, instruct the Contractor to carry out such adjustment or modification at his own cost to satisfy the requirements of Integrated Testing and Commissioning within such time as the Employer / Engineer may deem to be reasonable.

8. 24 RETESTING

If the Works, or a part thereof, or a Section, or a plant & equipment and manufactured item fail to pass the Integrated Testing and Commissioning, the Engineer shall require such failed Test(s) to be repeated under the same terms and conditions. If such failure and retesting results due to the fault of the Contractor and cause the Employer to incur additional cost, the same shall be recoverable from the Contractor by the Employer and shall be deducted by the Employer from any money due or to become due, to the Contractor.

8. 25 STATUTORY REQUIREMENTS

The Contractor along with others Contractor(s) shall carry out all statutory tests and trials under the supervision of the Engineer, necessary for obtaining sanction of the competent authority, if required, for opening the Railway System.

8. 26 TRIAL RUN AND COMMISSIONING

Following satisfactory completion of the Integrated System Test, the Employer will commence an extended period of trial run to prove all technical systems to the satisfaction of the Engineer and Commissioner for Railway Safety or any other

Authorized Official and to allow all technical systems to settle and to train staff to become conversant with the working procedures. The Contractor's personnel shall be available throughout the scope of work over the whole of this period. After successful Trail Run and obtaining statutory clearances / approvals from CRS / EIG and / or other relevant authorities, the Works shall be commissioned with the consent of the Engineer.

8. 27 TESTING RECORDS

- (1) The Contractor shall submit manufacturer's type and routine test certificates and reports for each equipment and device. Complete test results are to be submitted in clearly identified and organized booklet, indicating item of equipment, make, model, type, date of tests, and type of tests, descriptions and procedures. Test reports shall also include the Quality Assurance Certification, the standards to which the equipment comply, and the standards to which the equipment was tested.
- (2) The Contractor shall submit to the Engineer for review, not less than six (6) months before testing and commissioning activities commence his proposed format for testing and commissioning records. The records shall be appropriately sub-divided to make provision for the various parts of the Permanent Works covered by the Contract.
- (3) The format of the records shall cover all tests, provide positive identification by serial number for assemblies and sub-assemblies of the Works and show modifications to Employer's drawings and diagrams or "As Built" data to be certified by the Engineer in the course of installation, testing and commissioning.
- (4) The Contractor shall, during the execution of the Works, prepare such reports and record of design, manufacture, installation and testing, as may be required, in order that a license may be issued or statutory requirements may be met or approval given. Such reports or records shall be adequate to enable each part of the Permanent Works to be commissioned and to meet the requirements of the licensing authority or any standing statutory regulations and shall be reviewed by the Engineer.
- (5) The Contractor shall obtain report of each inspection and/or test. Such report shall show the result of all the inspections and/or tests carried out and shall certify that the work has been inspected and/or tested in accordance with the requirements of the Contract and that the work complies with the requirements of the Contract.
- (6) The Contractor shall prepare an inspection or test report immediately after the completion of each inspection or test whether or not witnessed by the Employer or the Engineer. If the Employer or the Engineer has witnessed the inspection or test, he may countersign the inspection or test report to indicate his review of the information and conclusions (i.e. whether or not the equipment being inspected or tested has passed satisfactorily) contained therein) If the Employer or the Engineer has not witnessed the inspection or test (i.e. if a waiver has been granted, or the Employer or the Engineer has not witnessed the inspection or test for some other reason in accordance with the Contract), the Contractor shall forward two copies of the inspection or test report without delay to the Engineer. The Engineer will countersign the report to indicate his review of the information and conclusions (i.e. whether or not the equipment being inspected or tested has

passed satisfactorily) and return one copy to the Contractor. Where the results of the inspection or test do not meet the requirements of the Specification, the Employer/ the Engineer may call for a re-inspection or re-test.

- (7) The Contractor shall carry out an analysis of the results and certify that the work has been inspected/tested in accordance with the requirements of the contract and the work complies with the requirements of the Contract.
- (8) Authorized representative of the Contractor, who has been assigned the required authority under the relevant quality plan, shall sign each report of inspection and/or test.
- (9) In addition to any other requirements, the report shall contain but not limited to as below:
 - (a) Material or part of the Works tested;
 - (b) Location of the batch from which the samples were taken or location of the part of the Works;
 - (c) Place of testing;
 - (d) Date and time of tests;
 - (e) Weather conditions in the case of in-situ tests;
 - (f) Technical personnel supervising or carrying out the tests or inspection;
 - (g) Size and description of samples and specimens;
 - (h) Method of sampling;
 - (i) Properties tested or inspected;
 - (j) Method of testing or inspection;
 - (k) All relevant checklists and work sheets used during the inspection and/or test , including readings and measurements taken during the tests;
 - (l) Test results, including any calculations and graphs;
 - (m) Specified acceptance criteria; and
 - (n) Other details stated in the Contract.

After Commissioning of a part of the Works, the Contractor shall complete each commissioning record in the agreed format and shall forward copies of the record to the Engineer for review

(End of Chapter-8)

CHAPTER-9: SITE SAFETY

9.1 GENERAL

9.1.1 DFCC has prepared its own Safety, Health and Environment (SHE) Manual which is attached in Reference Documents – Part 4 of Bidding Documents. This SHE Manual shall be applicable on the Works being carried out under this Contract. Various penalties as stipulated in the said manual shall be applicable under this Contract for violation of relevant stipulations.

9.2 CONTRACTOR'S RESPONSIBILITY FOR SAFETY

9.2.1 The Contractor shall comply with all safety and industrial health legislation including, without limitation to the rules and regulation of the National Safety Council of India.

9.2.2 The Contractor shall develop its own Safety and Health procedures and systems in line with SHE Manual of DFCCIL and in compliance to applicable acts and legislations.

9.2.3 The Contractor shall, within Fifty Six (56) days of the Commencement Date, prepare and submit to the Engineer for review his proposed Safety, Health & Environment Management Plan.

9.2.4 The Contractor is required to develop systems and procedures for ensuring compliance with all the precautions required for the safety of the workmen.

9.2.5 The Contractor shall produce a policy statement signed by the Managing Director of the Contractor or other senior officer acceptable to the Engineer, or the Managing Directors or other senior officers acceptable to the Engineer of each company of the consortium, partnership or joint venture comprising the Contractor,

- (1) Declaring that the safety and industrial health will be given priority consideration in all aspects of the Works and by the Contractor in discharging his contractual obligations;
- (2) Reflecting an understanding of and means of ensuring due compliance with the statutory regulations and standards relating to construction work in India;
- (3) Indicating the statutory and contractual obligations regarding safety, rescue and industrial health imposed on the Contractor and the means by which the Contractor will supervise, monitor and audit his site safety assurance system to ensure due compliance with these obligations.

9.2.6 The Contractor must comply with all regulation regarding scaffolding, ladders, working platform, excavation, etc. as per SHE manual of DFCCIL.

9.3 SITE SAFETY INSPECTIONS

The Contractor shall conduct Site safety inspections at a regular frequency. The findings of the inspections shall be recorded on suitable forms which shall be kept available for inspection by the Engineer.

9.4 APPOINTMENT, DUTIES AND RESPONSIBILITIES OF SAFETY STAFF

9.4.1 The safety staff and organizational structure, which should identify the personnel to be, engaged solely for site safety assurance, the responsibilities of the participants and the

subdivision of the site safety assurance tasks into elements which can be effectively controlled, technically and managerially.

- 9.4.2 Names, addresses, telephone, email and fax numbers of all participants shall be listed where known (supplements to the site safety plan will update and complete this information).
- 9.4.3 The powers vested in the safety staff, which shall be sufficient to enable them to take urgent and appropriate action to make safe the site and prevent unsafe working practices or other infringements of the safety plan or statutory regulations.

9.5 POLICY FOR IDENTIFYING HAZARDS

- 9.5.1 The Contractor shall produce a list of safety and health hazards identified for this Contract and the procedures and method statements for achieving effective and efficient minimization of the risks associated with such hazards. Such list shall also include the aspects of temporary work design which directly or indirectly has an impact on the safety of the works. These shall be submitted to the Engineer for his approval.

9.6 SAFETY OF THE EQUIPMENT

- 9.6.1 The Contractor shall produce policy and procedures for ensuring that all his plant and equipment used on the works site is maintained in a safe condition and is operated in a safe manner.
- 9.6.2 The Contractor must comply with all regulation regarding scaffolding, ladders, working platform, excavation, etc. as per SHE manual of DFCCIL.
- 9.6.3 The means by which safety equipment, scaffolds, guard-rails, working platforms, hoists, ladders and other means of access, lifting, lighting, signing and guarding equipment shall be inspected, tested and maintained and the standards below which such items will be removed from the site and replaced, shall be elaborated.

9.7 SAFETY AND HEALTH PROCEDURES

- 9.7.1 The Contractor shall produce regulations and procedures covering safety and health aspects of the Works as applicable, but not limited to the following:
- (a) Housekeeping
 - (b) Working on or near operating railways
 - (c) Fire prevention precautions and firefighting equipment
 - (d) Working in confined spaces
 - (e) Excavation
 - (f) Hot weather working
 - (g) Electrical equipment
 - (h) Welding/cutting operations and equipment
 - (i) Personal protection clothing and equipment
 - (j) Cranes

- (k) Hoists
- (l) Other lifting appliances
- (m) Manual lifting
- (n) Ladders
- (o) Power tools
- (p) Hand tools and portable power driven tools
- (q) Hazardous substances
- (r) Working at height
- (s) Structural steel erection
- (t) Lighting
- (u) Protection against falling objects;

9.7.2 Sub-Contractors

- (1) The means by which safety, rescue and industrial health matters and requirements will be communicated to sub-Contractors of all tiers and their due compliance with the site safety plan and all relevant statutory regulations is ensured by the Contractor.
- (2) The method by which the safety procedures and practices proposed by sub-Contractors will be reviewed for compliance with the site safety plan and statutory regulations including the provision of hazard and risk assessments and method statements.

9.7.3 Disciplinary Procedures

The Contractor's disciplinary procedures with respect to dealing with safety related matters both with his own staff and that of sub-Contractors shall be given.

9.7.4 Accident Reporting

The Contractor's procedure for reporting and investigating accidents, dangerous occurrences or occupational illness;

9.7.5 Safety Promotion

The Contractor shall provide details of the frequency, coverage and intent of site safety meetings together with the rationale for attendance.

9.7.6 Site Security

- (1) The Contractor's system for the protection of authorized and unauthorized visitors to the site;
- (2) The Contractor's proposals to ensure that construction methods do not compromise the Contractor's commitment to the site safety plan or its compliance with the statutory regulations.

9.7.7 Labour Safety

- (1) The activities of Contractor shall be coordinated with Indian Railways so as to ensure safety of all Contractors' personnel as required.

- (2) Labour safety arrangements by the Contractor shall be in accordance with the applicable legislation in India.
- (3) The design and construction shall comply with the applicable legislation in India.
- (4) The Contractor shall provide the equipment needed for the labour safety during the operation of the line.

9.7.8 Legislation And Codes Of Practice

- (1) The Contractor shall comply with all safety and industrial health legislation including, without limitation, the rules and regulation of the National Safety Council of India.
- (2) The Contractor shall keep on the site copies of safety and industrial health regulations and documents.
- (3) All regulations and documents referred in this clause shall be translated into languages which are understood by the operators and supervisors engaged by the Contractor or sub-Contractors and such translations shall be displayed or kept alongside those in English language.

9.8 SITE SAFETY PLAN

The brief outline of site Safety plan shall cover the following:

(1) Safety Personnel

- (a) The Contractor shall appoint a 'System Safety Expert' whose duties throughout the period of the Contract shall be entirely connected with the safety and industrial health aspects of the Contractor's activities on the site.
- (b) The System Safety Expert shall be a suitably qualified and experienced person who shall supervise and monitor compliance with the site safety plan.
- (c) The System Safety Expert shall, in particular but without limitation, carry out auditing of the operation of the site safety plan in accordance with a rolling program to be submitted, from time to time, to the Engineer for his consent.
- (d) The System Safety Expert's appointment shall be within fifty six (56) days of the Commencement Date and shall be subject to the Engineer's written consent.
- (e) The Contractor shall not undertake any works on the site until the System Safety Expert has commenced duties at site and unless the Engineer has specifically consented in writing.
- (f) The Contractor shall not remove the System Safety Expert from the site without the express permission of the Engineer. Within fourteen (14) days of any such removal or notice of intent of removal, the Contractor shall nominate a replacement safety officer for the Engineer's consent.
- (g) The Contractor shall maintain the adequate supporting Safety Inspection staff at each site during the execution of work in accordance with the staffing levels set out in the site safety plan. Such safety assurance staff shall be deployed for each shift of duty at work site.

- (h) The supporting staff shall include at least one Deputy System Safety Expert, whose appointment(s) shall be subject to the Engineer's consent.
- (i) The Deputy System Safety Expert (s) shall be capable of assuming the duties and functions of the safety officer as contained in the site safety plan whenever necessary.
- (j) The Contractor shall ensure that the System Safety Expert maintains a daily site safety diary, such diary comprehensively recording all relevant matters concerning site safety, safety inspections and audits, safety related incidents and the like.
- (k) The site safety diary shall be reviewed and signed on a weekly basis by the Contractor's site representative and shall be available at all times for inspection by the Engineer.
- (l) The Contractor's staff organization plan shall show direct lines of communication and reporting between the System Safety Expert and the Contractor's site representative and between the safety officer and the person responsible for the Contract.
- (m) The Contractor shall instruct and require the Contractor's site representative and the person responsible to be directly accountable in all matters concerning site safety.

(2) Site Safety Inspections

- (a) The Contractor will conduct site safety inspections at a regular frequency.
- (b) The findings of the inspections shall be recorded on suitable forms which shall be kept available for inspection by the Engineer.

(3) Safety / Accident Reporting

- (a) The Contractor shall submit regular site safety reports to the Engineer in accordance with the site safety plan.
- (b) Such reports shall be submitted as part of the Monthly Progress Report. Prior to submission, the site safety report shall be endorsed by the Project Director responsible for the Contract and the Contractor's site representative.
- (c) Site safety reports shall comprehensively address all relevant aspects of site safety and industrial health regulation and, in particular, report on all site safety audits undertaken during the period covered by the report.
- (d) The Engineer shall be notified by the Contractor immediately of occurrence of any accidents whether on-site or off-site in which the Contractor, its personnel or plant, or those of its sub-Contractors are directly or indirectly involved and which results in any injuries to any persons, loss / damage to plant and machinery, disruption of traffic etc.
- (e) Such initial notification may be verbal and shall be followed by a written comprehensive report within 24 hours of the accident.
- (f) Additionally the Contractor shall notify the Engineer in writing within twenty four (24) hours of any incident occurring whether on-site or off-site at which the Contractor or any sub-Contractors are involved and could have resulted

in serious injuries to persons or significant damage to the Works. Failure to report such incidences shall be considered as a serious breach of Safety Procedures.

(4) Sub-Contractors

- (a) The Contractor shall provide its sub-Contractors with copies of the site safety plan and shall incorporate into all sub-contract documentation provisions to ensure the compliance with such plan at all tiers of the sub-contracting.
- (b) The Contractor shall, with the Engineer's consent in writing, instruct all sub-Contractors to appoint a safety representative who shall be available on the site throughout the operational period of the respective sub-contract.
- (c) These safety representatives shall ensure that all employees of sub-Contractors working at site are conversant with appropriate sections of the site safety plan and the statutory regulation.

(5) Safety Meetings

- (a) The Contractor shall convene regular safety meetings in accordance with the safety plan and shall ensure attendance by the safety officer and safety representatives of sub-Contractors unless otherwise agreed by the Engineer.
- (b) All safety meetings shall be notified in advance to the Engineer who may attend in person or by representative at his discretion.
- (c) The minutes of all safety meetings shall be taken and sent to the Engineer within seven (7) days of the meeting.
- (d) A site safety management committee may be established by the Engineer to monitor the implementation of the safety plan and for the purposes set out in the project safety manual.
- (e) The Engineer or his representative will be the Chairman of this committee and the members shall include the Contractor's agent or representative, safety manager and safety officers, sub-Contractors' safety personnel.

(6) Safety Equipment

- (a) The Contractor shall identify the safety equipment, rescue apparatus and protective clothing which will be required for the Works.
- (b) The identification shall include the quantity, sourcing, standards of manufacture, storage provisions and means of ensuring proper utilization by all workmen and staff employed directly or indirectly by the Contractor and repair to or replacement of damaged equipment.
- (c) The Contractor shall ensure that safety equipment and protective clothing as described in the safety plan is available and used on the site at all material times and those measures for the effective enforcement of proper utilization and necessary replacement of such equipment and clothing is incorporated into the site safety plan. Such equipment shall include, but not be limited to, site helmets, goggles and other eye protectors, hearing protectors, safety harnesses, safety equipment for working in confined

spaces (e.g. sewers, drains etc.), rescue equipment, equipment to rescue persons from drowning (if applicable), fire extinguishers, first aid equipment, and, where appropriate, suitable fall arrest equipment.

- (d) The Contractor shall regularly inspect, test and maintain all safety equipment, scaffolds, guard-rails, working platforms, hoists, ladders and other means of access and egress, lifting, lighting, signage and guarding equipment.
- (e) Lights and signs shall be kept clear of obstructions and legible to read.
- (f) Equipment which is damaged, dirty, incorrectly positioned or not in working order shall be repaired or replaced immediately.

(7) First Aid

The Contractor shall establish, maintain, staff, and fully equip a first aid base as detailed below:

a. First Aid Base

- (i) First aid bases shall be located at each of the Contractor's principle work area.
- (ii) The First Aid base shall consist of a treatment room fitted with two treatment couches, two stretchers, a hand wash basin, sterilizing equipment and lockable cupboards to contain sufficient medical supplies for the Contractor's personnel, the Employer's / the Engineer's personnel including visitors to the Site.
- (iii) The first aid base shall contain a recovery room that shall be furnished with six chairs and a center table.
- (iv) The first aid base shall be air-conditioned with cooling and heating capability sufficient to maintain the inside temperature at 22°C.
- (v) Portable First Aid box shall be maintained fully equipped at each of local site offices and work locations where twenty (20) or more persons work at a time.

b. Staffing

- (i) A qualified doctor shall be available on call during all times when work is being undertaken on Site.
- (ii) A nurse/ para medical staff shall be in attendance at the first aid bases during all times when work is being undertaken on the Site.
- (iii) In each Site office and location, at least one employee of the Contractor shall be trained in first aid and shall be available during all working hours for the purpose of attending to emergencies.
- (iv) The Contractor may conclude a contract with the local health centre(s), where they are unable to implement any of the above services, as approved by the Engineer.

c. Equipment

- (i) A fully equipped ambulance and driver shall be available on call during all working hours.

- (ii) The ambulance shall be equipped with emergency life support equipment suitable for application in construction Site accidents.
- (iii) Portable first aid boxes will be maintained fully equipped at each of local Site offices and work locations where twenty (20) or more persons work at a time.

(8) Site Publicity

- (a) The Contractor shall ensure that safety, rescue and industrial health matters are given a high degree of publicity to all persons regularly or occasionally on the site.
- (b) Posters, in both Hindi and English, drawing attention to site safety, rescue and industrial health regulation shall be made or obtained from the appropriate sources and shall be displayed prominently in relevant areas of the site.
- (c) These posters shall be changed on a monthly basis in order to ensure their continued impact.
- (d) All personnel whether permanent, temporary or visitors, will be given a site safety induction before they are allowed on to the site.

(9) Training

- (a) The Contractor shall conduct regular safety training and rescue training drills, the frequency, coverage and application of which shall be in accordance with the site safety plan and in any case shall not be more than every six months. Engineer may monitor the content of such training programs.
- (b) The Contractor shall require that all sub-Contractors' employees participate in relevant training courses appropriate to the nature, scale and duration of the sub-contract works.
- (c) The Contractor shall produce a description of the safety training courses that are to be provided. The syllabus, frequency, coverage and application of training courses shall be included together with the means of attaining the objective that all workmen shall be required to attend a safety induction course within their first week on site and thereafter at times appropriate to their prospective duties and at intervals of not more than six months. A summary of such training program conducted/ planned shall form part of Monthly Progress Report.

(10) Breach of Safety Regulations

- (a) Any employees of the Contractor or sub-Contractor of any tiers who commit a serious breach of the safety regulations shall be liable to summarily dismissal and shall not be re-employed on the Contract or allowed on any of the sites.
- (b) The due notice of this sanction shall be prominently displayed on the site.

(11) Safety Devices

- (a) All plant and equipment used on or around the site shall be fitted with appropriate safety devices which shall be operational at all times and shall

be regularly inspected and tested.

- (b) These shall include, amongst others, effective safety catches for crane hooks and other lifting devices.
- (c) Functioning automatic warning devices and where applicable, an up-to-date test certificate, for cranes and hoists.
- (d) All plant and equipment used on or around the site shall be operated by suitably trained and qualified personnel with valid licenses from the appropriate authorities.

(12) Testing and Certification of Lifting Gear

- (a) The Contractor shall provide and maintain safe mechanical cranes, hoists and conveying facilities for the lifting and transport of material and shall comply with all relevant codes of practice for safe use of cranes.
- (b) All cranes, hoists and the like shall be fitted with audible overload warning devices.
- (c) All such equipment shall be regularly maintained in accordance with manufacturers' recommendations and standards having regard to local legislation and recommendations from the appropriate statutory authority.
- (d) Prior to use on site, all lifting appliances and lifting gears shall be tested to an approved safety margin and suitably identified in accordance with the requirements of the current legislation.
- (e) The test certificate shall be submitted to the Engineer for review prior to the use of such equipment on site.
- (f) The safe working load shall be clearly and indelibly marked on all lifting appliances and lifting gear either by stamping or by the addition of permanently secured tag labels.
- (g) Stamping shall not be permitted on any stress-bearing part.
- (h) The Contractor shall prepare and maintain an up-to-date register containing test certificates of all lifting and hoisting equipment used on the Works.
- (i) The Contractor shall notify the Engineer of the person responsible for maintaining this register.
- (j) The register shall, from the commencement of construction, be available on site for inspection by the Engineer and relevant authorities.
- (k) Heavy plant or equipment, which does not come under the jurisdiction of any local statutory legislation, shall be subject to the testing and examination requirements as recommended by its manufacturer or in the absence of such, it shall be the responsibility of the Contractor to submit a standard or method of testing and examination to the Engineer for review.
- (l) Competent operators with certificates certifying that the proposed operator has received training in the general principles of crane operation and specific training in the type of lifting or hoisting equipment he is required to operate shall be provided for the control of all lifting and hoisting equipment.

(13) Fire Regulations and Safety

- (a) The Contractor shall provide and maintain all necessary temporary fire protection and firefighting facilities on the site during the construction of the Works, and shall comply with all requirements of the local fire services department.
- (b) These facilities may include, without limitation, sprinkler systems and fire hose reels in temporary site buildings, raw water storage tanks and portable fire extinguishers suitable for the conditions on the site and potential hazards.
- (c) The Contractor shall submit details of these facilities to the Engineer for review prior to commencement of work on the site.
- (d) If, in the Engineer's opinion, the use of naked lights may cause a fire hazard, the Contractor shall take such additional precautions and provide such additional firefighting equipment as the Engineer considers necessary.
- (e) The term "naked light" shall be deemed to include electric arcs and oxyacetylene or other flames used in welding or cutting metals.
- (f) Oxyacetylene burning equipment will not be permitted in any confined space. If required, the burning equipment of the oxy-propane type shall be used.

(14) Interface with Indian Railway Operations

- (a) The Contractor will review the interfaces with Indian Railway's operations and prepare a specific safety plan for all works that may affect the operating railway.
- (b) The Contractor will comply with and incorporate Indian Railway's rules and regulations for track, Signalling and operations possessions into his safety plan and will operate a permit to work system for all works which may affect the operations of the existing railway.

Similarly, the site safety plan shall consider with other interfacing contractors in the closed vicinity of the Employer.

(15) Electrical Safety

(a) Safety measures while working in OHE area

- (i) While working near the OHE area, as a minimum the safety guidelines as specified in para 20301, 20327, 20334, 20335, 20529, 20612, 20614, 20714, 20825, 20833, 21206 and 21207 of Volume II, Part 1 of AC Traction Manual of Indian Railways shall be followed.
- (ii) No work close to the live OHE shall be carried out without power block unless the work area is properly screened, barricaded, earthed and supervised by a competent Engineer subject to specific approval from Engineer / Employer.
- (iii) A minimum Working Clearance of 2m shall be maintained between live OHE wire and any body part of the workmen or tools or metallic support etc.

- (iv) No electric connection shall be tapped from OHE.

(b) Safety Requirements for Electrical Works

- (i) The Indian Electricity Rules 1956 and Indian Electricity Act 2003 as amended up to date shall be followed. The detailed instructions on safety procedures given in Indian Standards, Indian Electricity Rules and respective State Electricity Authorities' regulation with up to date amendment shall be applicable.
- (ii) The LT/HT distribution diagrams of sub stations shall be prominently displayed. The substation premises, main switch rooms and D.B. enclosure shall be kept clean whenever works are carried either inside or outside.
- (iii) No flammable material shall be stored in places other than the rooms specially constructed for this purpose in accordance with the provisions of Indian Explosives Act
- (iv) Rubber insulating mats of suitable size and thickness shall be provided in front of the main switch boards of sub-station or any other control equipment of medium voltage and above.
- (v) Protective and safety equipment such as rubber gauntlets or gloves, earthing rods, linemen's belt, portable artificial respiration apparatus, safety goggles etc., shall be provided as per the requirement of the Work.
- (vi) Necessary number of caution boards such as "Man working on line, Don't switch on" shall be readily available in the vicinity of electrical installation.
- (vii) Standard first aid boxes containing material as prescribed by the St. John's Ambulance Brigade or Indian Red Cross shall be made available.
- (viii) Charts displaying methods of giving artificial respiration to a recipient of electrical shock (one in English and another one in the regional language) shall be prominently displayed at appropriate places.
- (ix) No work shall be undertaken on live installations, or on installation, which could be energized unless another person is present to immediately isolate the electric supply in case of any accident and to render first aid, if necessary
- (x) No work on live L.T. bus bar or pedestal switch board in the sub stations should be handled by a person below the rank of a Licensed Wireman and such a work should preferably be done in the presence of a qualified engineer.
- (xi) When working on or near live installations, suitable insulated tool should be used and special care should be taken to see that those tools accidentally do not drop on live terminals causing shock or dead short.
- (xii) The electrical switch controls in distribution boards shall be clearly marked to indicate the areas being controlled by them.

- (xiii) Before starting any work on the existing installation, it shall be ensured that the electric supply to that portion is cut off. Precautions, like displaying "Men at Work" caution boards on the controlling switches, removing fuse carrier from these switches shall be taken against accidental operation. Caution boards shall be kept with the person working on the installation.
- (xiv) All electrical panels & switchgear shall conform to relevant Standard.
- (xv) All external enclosures shall have degree of protection as specified in the Particular Specifications Vol. 2, 3, 4 & 5.
- (xvi) All equipment / sub-systems shall conform to relevant IEC standard on Electromagnetic Compatibility (EMC).
- (xvii) Cable routes of all the newly laid cables by the Contractor shall be identified with concrete markers.

(16) Standby Equipment

The Contractor shall provide adequate stand-by equipment to ensure the safety of personnel, the Works and the public.

(17) Co-operation

The Contractor shall provide full co-operation and assistance in all safety surveillance carried out by the Engineer or the Employer. Any breaches of the site safety plan or the statutory regulations or others disregard for the safety of any persons may be the reason for the Engineer to exercise his authority to require the Contractor's site representative's removal from the site. Besides this Engineer may impose token penalty for such lapses as considered fit.

9.9 HEALTH

The Contractor shall ensure that the provision of SHE Manual of the DFCCIL regarding occupational health & welfare are follow for workmen deployed under this Contract.

(End of Chapter-9)

CHAPTER-10: INTERFACE MANAGEMENT

10.1 GENERAL

- (1) The Contractor (CP-105) shall be responsible for interface planning and management of all the systems works: Signalling & Telecommunication, Power supply Installations, OHE, SCADA and E&M works within the scope of his Contract with the Civil / Track Works Contractor and Contractor(s) for Signalling & Telecommunication, OHE and SCADA works in the adjoining section(s).
- (2) The Contractor shall co-ordinate its interface requirements with the Employer and other interfacing contractors i.e. CST and other contractor(s) etc. which the Employer may engage from time to time in such a manner so as to minimize disruption to any party arising from such concurrent work.
- (3) The co-ordination responsibilities of the Contractor shall include, but not be limited to the following:
 - (a) Provision of all information reasonably required by the interfacing parties in a timely and professional manner to allow them to proceed with their design or construction activities and specifically to meet their contractual obligations.
 - (b) Assurance that the interfacing parties' requirements are provided to all other interfacing parties in time providing them ample opportunity to do their part of requirement for interfacing.
 - (c) Receipt from the interfacing parties of such information as is reasonably required to enable the Contractor to meet the design submission schedule as identified in Chapter - 4 "Project Program Requirements" of this GS.
 - (d) Where the execution of the work of the interfacing parties depends upon the Site management or information to be given by the Contractor, the Contractor shall provide to such interfacing parties the services or information required to enable them to meet their own program or to enable them to construct their work.
 - (e) Co-ordination of track possessions, access and delivery routes, and assurance that all provisions for access and delivery of Plant are coordinated with and reflected in the interfacing parties' delivery route drawings.
 - (f) Co-ordination with the interfacing parties in attendance.
 - (g) The Contractor shall conduct separate meetings with the interfacing parties as necessary to clarify particular aspects of the interfacing requirements of the Works.
 - (h) The party convening the meeting shall prepare minutes recording all matters discussed and agreed at the meeting.
 - (i) Assurance, copies of all those correspondence, drawings, meeting minutes, programs, etc. relating to the Contractor's co-ordination with the interfacing parties are issued to all concerned parties and four (4) copies issued to the Engineer no later than seven (7) calendar days from the date of such correspondence and meetings.

- (4) The Contractor shall, in carrying out his co-ordination responsibilities, provide sufficient information for the Engineer to decide on any disagreement between the Contractor and the interfacing parties as to the extent of services or information required to pass between them.
 - (a) If such disagreement cannot be resolved by the Contractor despite having taken all reasonable efforts, the decision of the Engineer shall be final and binding on the Contractor(s).
 - (b) Where an interfacing contract is yet to be assigned, the Contractor shall proceed with the co-ordination activities with the Engineer until such time as the interfacing contractor is appointed.
 - (c) The Contractor shall note that the information exchange is an iterative process requiring exchange and updating of information at the earliest opportunity and shall be carried out on a regular and progressive basis so that the process is completed for each design stage by the respective dates.
 - (d) The Contractor shall co-ordinate with the Engineer on all matters relating to works that may affect the IR operation on the existing railway. Such works shall be carried out in accordance with IR Rules and Regulations.
- (5) Obtaining relevant certificate(s) and / or clearance(s) from local/civil authorities/commissioner of Railway Safety (CRS)/ Electrical Inspector to the Government of India (EIG) viz. completion certificate, fire clearance or any other mandatory clearances, which may be specified by these authorities from time to time. Where applicable, the Employer/Engineer shall assist the contractor in obtaining the approval of such authorities. No claim for delay or compensation from the contractor on this account shall be tenable.

10.2 INTERFACE MANAGEMENT PLAN (IMP)

- (1) Contractor shall be responsible for identifying all internal and external interfaces and shall develop and maintain a full interface management system which shall cover the functional and technical aspects of all the internal and external interfaces of the Contractor.
- (2) The Contractor shall prepare and submit an IMP which shall identify the interface manager, the structure and responsibilities of the interface management team and the procedures that will be implemented to identify and close out all interfaces.
- (3) The Interface Management Plan shall:
 - a. Identify the sub-systems as well as the works and facilities with interfacing requirements;
 - b. Define the authority and responsibility of the Contractor's and all other contractors' (and any relevant sub-contractors') staff involved in interface management and development;
 - c. Identify the information to be exchanged, precise division of responsibility between the Contractor and the other contractor(s) and integrated tests to be performed at each phase of the Contractor's and other contractors' works;
 - d. Address the works program of the Contract to meet the key dates of each contractor and highlight any program risks requiring the Employer's attention

- keeping in view timeline of systems contractor;
- e. Address the interface issues during Design as well Construction.
- (4) The Interface Management Plan shall include procedures for identifying and resolving interfaces within the Contractor's scope of work between the Contractor and the Employer and between the Contractor and other contractor(s).
- (5) The timescale for resolving interfaces shall be set down in Co-ordinated Installation Plans (CIP) and with the other contractors.
- (6) All interfaces shall be documented through the use of interface co-ordination documents to ensure that each interface is identified, the responsibilities to provide information are defined, the criteria for resolution are agreed and the progress to resolution can be tracked at all times.

10.2.1 Design Interface

- (1) The Contractor shall commence the design interface with the interfacing contractor as soon as he has been notified by the Engineer that the contract has been awarded to the Interfacing contractor.
- (2) In the case of utility agencies and other statutory boards, interfacing shall commence as soon as it is practicable.
- (3) The Contractor shall, immediately upon award of Contract, gather all necessary information and develop his design to a level where meaningful interaction can take place.
- (4) The Contractor shall submit together, with each of his Design submissions a joint statement from the Contractor and the relevant interfacing party confirming that design co-ordination has been completed and that they have jointly reviewed the appropriate document to ensure that a consistent design is being presented.
- (5) The design interface is an iterative process requiring regular exchange and update of interfacing information and the Contractor shall ensure that the information it requires from the interfacing parties is made known at the outset of each design interface so that the information can be provided in time for the Contractor and the interfacing parties to complete their design to meet their various design submission stages.

10.2.2 Construction & Installation Interface

- (1) Construction & Installation interfacing will be necessary throughout the duration of the Works commencing from the time the Contractor mobilizes on the Site to the completion of the Works. Construction interfacing will overlap the design interface and involve the definition of interfacing parties' requirements that are to be incorporated at the initial stages of the Contractor's installation up to provision of attendance during the testing and commissioning stage.
- (2) The Contractor shall ensure that there is no interference with the Works of the interfacing parties and shall maintain close co-ordination with them to ensure that his work progresses in a smooth and orderly manner.
- (3) The Contractor shall carry out and complete the Works or part thereof, in such order as may be agreed by the Engineer or in such revised order as may be instructed by the Engineer from time to time.

- (4) The Contractor shall liaise with the other contractors in the preparation of Installation Plan which shall include plans prepared collectively and agreed between the Contractor and any other contractor.
- (a) These Installation Plans shall show, in respect of each other contractor, a design interface, Site access, and installation interfacing.
 - (b) The Design Interface phase shall be sufficient for the Contractor and the other contractors to integrate the designs of their respective works.
 - (c) The installation interface shall be agreed between the Contractor and the other contractors to ensure that each has sufficient access to the Site for the purpose of carrying out their respective works. The Installation interface shall commence after the Design interface of the related activity is concluded.
 - (d) The Installation Plan shall be fully conforming to the approved Works Program and shall be in logical agreement with all access and Mile stones which shall be clearly identified in the Installation Plan.
 - (e) The Installation Plan shall indicate dates for the commencement and completion of each principal activity on Site and delivery and installation of principal items of equipment.
 - (f) The Installation Plan shall be updated at regular intervals not exceeding 28 days and agreed with other contractors subject to the approval of the Engineer.
 - (g) Should it appear to the Engineer that the actual progress of the Works, the Works Program or the three month rolling program do not conform with the Installation Plan, the Contractor shall be required to revise all such programs and plans such that they do reflect the progress of the Works, are mutually consistent and conform to other provisions of the Contract.
 - (h) The Installation Plan shall allow adequate time periods for each interfacing party and the Contractor to install their plant and equipment in the interfacing areas.
 - (i) The Installation Plan shall be agreed with and signed off by each interfacing party and then submitted to the Engineer not later than three (3) months before the earliest Works Area access date.

10.2.3 Employer's/Engineer's Input

- 1) The Engineer will coordinate the activities of the Contractor with reference to interfacing with other contractors and agencies during all the phases of the Contract.
- 2) The Employer/Engineer, within the scope of the relevant Contract provisions, will support and assist the Contractor in interfacing with Indian Railways Authorities, State and local authorities for timely receipt of the required permits, certificates and approvals related to the design and construction process;
- 3) This support and assistance of the Employer/Engineer shall not absolve the Contractor of any of his obligations under this Contract.

10.3 INTERFACE CO-ORDINATION DOCUMENT (ICD)

- 10.3.1 The Contractor shall create, in co-ordination with the other contractors, an Interface Co-ordination Document (ICD) for each interface, which shall be signed by all the parties involved.
- 10.3.2 An interface list shall be prepared and maintained by the Contractor and updated on a regular basis to reflect the actual needs of both parties.
- 10.3.3 The Contractor shall co-ordinate all interface items on the list and agreed solutions with the other contractors.
- 10.3.4 ICD shall be created for each interface describing, in a formal manner, the particulars of the functional and technical requirements to be implemented.
- 10.3.5 ICD shall be updated on a regular basis as information becomes available or agreement is reached between two contractors.

10.4 DEDICATED CO-ORDINATION TEAM

- (1) The Contractor shall establish a dedicated co-ordination team led by an Interface Manager cum coordinator reporting to the Contractor's Project Director.
- (2) The primary function of the team is to provide a vital link between the Contractor's design and manufacturing teams and other contractors. The Contractor shall provide the Engineer with the particulars of the Interface Manager cum coordinator.
- (3) The Engineer shall have the right to replacement of the Interface Manager cum coordinator if in his opinion the Interface Manager cum coordinator is unable to meet the co-ordination requirements of the Contract.
- (4) The Contractor's attention is drawn to the need for the Interface Manager cum coordinator to establish effective dialogues and communication links with the CST and other interfacing contractors. The Contractor's co-ordination team for interfacing shall comprise a mix of personnel with experience in both design and manufacture of equipment comprising the Works, necessary for effective co-ordination.
- (5) The Interface Manager cum coordinator shall assess the progress of co-ordination with CST and other contractors by establishing lines of communications and promoting regular exchange and updating of information so as to maintain the Contractor's program.
- (6) The complexity of the project and the importance of ensuring that work is executed within the stipulated time require detailed programming and monitoring of progress so that early program adjustments can be made in order to minimize the effects of potential delays.

10.5 CO-ORDINATION WITH OTHER CONTRACTORS AND INDIAN RAILWAYS

- (1) The Contractor shall undertake co-ordination with other contractor(s) and Indian Railways.

- (2) The Contractor may commence design interfacing with other contractors and Indian Railways prior to the given period once information has been developed to a level where meaningful interaction can take place.
- (3) Design co-ordination shall include, but not be limited to, the following:
 - (a) Definition and agreement with other contractors of interface areas and contract limits;
 - (b) Definition and design approach by the Contractor with the other contractors and/or Indian Railways regarding environmental control requirements, system functionality requirements and control interfaces;
 - (c) Agreement of combined service drawings and structural opening drawings.
- (4) The Contractor shall liaise with the Engineer in developing a uniform identity code system which shall be used to uniquely identify each item of equipment and software component provided under this Contract and provided by the other contractors and/or Indian Railway.
- (5) Such identity codes shall be used for labelling each item of equipment and shall also be used in design reports, drawings and operations and maintenance manuals. Such codes shall comprise mnemonics for location names and equipment types as well as alpha-numeric for unique numbering.
- (6) The Contractor shall undertake Site activity co-ordination with the other contractors and/or Indian Railways within the periods stated for access and installation interfacing and co-ordination in the agreed Installation Plan.
- (7) The Contractor shall undertake installation and testing in accordance with the milestones set in the Contract and the dates in the Installation Plan and as agreed with the other contractors and/or Indian Railways.
- (8) The Contractor shall undertake a lead role in the co-ordination of the activities associated with integrated systems testing including the co-ordination of other contractors and/or Indian Railways to test and monitor their systems to prove the design and integrity of the systems as a whole.
- (9) It shall be the responsibility of the Contractor to secure from the other contractor(s) and/or Indian Railways, in a timely and correct manner as per the agreed Installation Plan, whatever interface provision is required for the Contractor to carry out its duties under the Contract.
- (10) Any additional cost arising to the Contractor due to his late and/or improper interfacing with the other contractors and/or Indian Railways, shall be to the Contractor's account. Such improper interfacing shall include, but not be limited to:
 - (a) Late provision of interfacing information
 - (b) Failure to adhere to agreed interface
 - (c) Changing an interface after it has already been agreed and signed off

(End of Chapter-10)

CHAPTER-11: QUALITY ASSURANCE AND MANAGEMENT

11.1 GENERAL

- 11.1.1 The Contractor shall maintain and implement a quality management system that shall remain in effect during the execution of the Works. The Contractor's quality management system shall be tailored specifically to the Contract and the Works in accordance with ISO 9001 – Quality Management System, the latest edition of the International Standard ISO 9001, and the Contractor shall submit his quality management system titled as the Project Quality Assurance Plan for Engineer's review as specified herein.
- 11.1.2 The Project Quality Assurance Plan documentation shall include, but shall not be limited to the following:
- (1) Project Quality Assurance Plan (Contractor's Integrated Quality assurance documentation);
 - (2) Design Quality Assurance Plan;
 - (3) Site Quality Assurance Plan (including Inspection and Test Plan);
 - (4) Manufacturing Quality Assurance Plans (including Inspection and Test Plan); and
 - (5) On-site Inspection Plan for Resources Procurement;
- 11.1.3 The Contractor shall plan, perform and record all quality control activities to ensure that all Works are performed in accordance with the requirements under the Contract and are detailed in the quality plans which are required herein. Such activities shall include, without limitation, the inspections and/or test expressly or implicitly required by the Contract.
- 11.1.4 Quality audits will be carried out by the Engineer and surveillance audit shall be carried out by Employer to verify the Contractor's implementation and compliance with the quality management system as specified herein.

11.2 SUBMISSION OF QUALITY DOCUMENTATION

- 11.2.1 Quality system documents to be submitted shall embrace all activities of the Contractor and his Sub-Contractors of any tier including his suppliers and any design consultants for the execution of the Works.
- 11.2.2 The Contractor shall prepare and submit the following documents for review by the Engineer:
- (1) Contractor's Quality Assurance Philosophy;
 - (2) Project Quality Assurance Plan; and
 - (3) Design Quality Assurance Plan and any associated work instruction and/or standard forms which the Contractor proposes to be used for the Contract.
- 11.2.3 The Contractor shall submit separate Site Quality Assurance Plan and Manufacturing Quality Assurance Plans for managing, controlling and recording the on-site construction and manufacturing process including off-site process for individual key items of the Works. The Manufacturing Quality Assurance Plan shall be submitted for review by the Engineer for his consent as part of Detailed Design development as described in Chapter

8: "Supply, Installation, Testing & Commissioning".

- 11.2.4 The Contractor shall submit separate On-site Inspection Plan for Resources Procurement for managing, monitoring and recording the on-site receipt of general construction resources including all construction material, labour forces and works and services delivered to the construction site. The On-site Inspection Plan for Resources Procurement shall be submitted for consent by the Engineer.
- 11.2.5 The Contractor shall continuously review and update the quality system documents to meet the requirements and development of the Works throughout the duration of the Contract. For any amendment to the quality system documents, the Contractor shall prepare and submit the proposed amendment for consent of the Engineer.
- 11.2.6 The Plan shall clearly define the Contractor's policy, Quality Assurance Organization, Management responsibility, the requirements for Quality Assurance personnel, their qualifications, skills and training, the Contractor's Quality Audit schedule.
- 11.2.7 Records of certifications shall be maintained and monitored by the Quality Assurance personnel. These records shall be made available to the Engineer / Employer for inspection and review as and when required.
- 11.2.8 The Quality Assurance operations shall be subject to the Engineer's verification at any time.
- 11.2.9 The verification will include surveillance of the operations to determine that practices, methods and procedures of the plan are being properly applied; inspection to measure quality of items to be offered for acceptance; and audits to ensure compliance with the Contract documents.
- 11.2.10 The Contractor's Quality Audit schedule shall be submitted to the Engineer for consent every three months or more frequently as required.
- 11.2.11 The Contractor shall provide all necessary access, assistance and facilities to enable the Engineer / Employer to carry out on-site and off-site Quality Audit / surveillance audit to verify that the Contractor's quality assurance system which has been consented by the Engineer is being implemented fully and properly.

11.3 CONTROLLED COPY OF QUALITY SYSTEM DOCUMENTATION

The Contractor shall promptly supply the Engineer with six (6) controlled copies of his quality system documents duly consented by the Engineer. The Contractor shall maintain such controlled documents throughout the duration of the Contract. In addition, the Engineer may request further copies of the quality system documents and these documents shall reach to the Engineer office within Fourteen (14) days of notification.

11.4 PROJECT QUALITY ASSURANCE PLAN

- 11.4.1 The Project Quality Assurance Plan shall establish the Contractor's management structure which functions efficiently to execute the Works in compliance with the Employer's Requirements under the Contract and shall, without limitation, define as follows:

- (1) A dedicated Quality Assurance Team;
- (2) Appointment of a Senior Design Engineer and a Quality Assurance Engineer as

described hereinafter;

- (3) A set of organization charts which depict in line with the Contractor's intent of the quality plans. Each organization chart shall identify the Contractor's managerial staff with reference to any member of the partnership, consortium or joint venture, and the main Sub-Contractors and indicate the reporting structure and the interface relationship between all parties involved;
- (4) Each organization chart which may be subdivided with regard to Works segments, site locations, and phases and stages of the project to ensure complete implementation of the quality management system in every part to the Work;
- (5) The Allocation of responsibilities and authorities given to managerial and technical staff with particular reference to the design and site supervision of the Works; and
- (6) Hierarchy of the quality management system documentation for managing and controlling the whole system.

11.4.2 The Contractor shall submit the Curriculum Vitae (CV) of each member of his Quality Assurance Team and other personnel relevant to his quality management system. Assignment of such personnel shall be subject to prior consent of the Engineer,

11.4.3 The Project Quality Assurance Plan shall without limitation include Quality Assurance procedures for design, construction, manufacturing, supply, installation, testing and commissioning and shall contain control processes for each stage in the Work such as design verification and validation, management of change control, non-conformance procedures, control on sub-standard practices, inspection, testing, auditing and so on.

11.4.4 The Project Quality Assurance Plan shall also include a full list of quality management procedures, method statements, inspection and test plans, standards and protocol and/or standard forms which shall form the frame work of the Project Quality Assurance Plan. It shall define specific procedures to perform the quality management activities and to record the evidence of the activities performed and/or the results achieved. It shall detail the system and the procedure by which the Contractor shall ensure that

- (1) The Quality Assurance Plan is fully observed at all times and
- (2) Any non-compliant and sub-standard material, practice and / or work are brought back to compliance.

11.4.5 It shall cover the requirements of the International Standard ISO 9001 in compliance with the Contract as precedence requirements and shall, without limitation, include the basic management disciplines as follows:

- (1) Review, approval and updating management of the quality system documents to ensure their continuing suitability and effectiveness;
- (2) Design control management to all Permanent Works and/or Temporary Works including design works carried out by Sub-Contractors and sub-consultants. The procedures shall clearly define the review and verification procedures of the designs submittals and the design packages described under the Contract;
- (3) Drawing management in the Contractor's main office and site office(s), including procedures of production, approval, updating, maintaining, storage and distribution;
- (4) Document management including procedures of registration, updating, indexing,

filing, maintenance, storage and distribution and monitoring and recording of the submission and re-submission to the Engineer;

- (5) Monitoring, recording and control of the quality system of his Sub-Contractors with respect to their quality of works with relevant time schedule; and
- (6) Quality control of the Works including Quality audits to be held on the Contractor and Sub-Contractors, suppliers and design consultants of any tiers.

11.5 DESIGN QUALITY ASSURANCE PLAN

The Contractor shall prepare the Design Quality Assurance Plan separately for its design Works. The Design Quality Assurance Plan shall establish the Contractor's policy for the design works in compliance with the Employer's Requirements under the Contract and shall, without limitation, define as follows:

- (1) Organization of the Contractor's Design Team in context with the Contractor's entire organization so as that it functions appropriately in this Design-Build Lump Sum Contract;
- (2) Allocation of responsibilities and authorities to be given to the Design Team, to the individual identified design staff and the Subcontractors for particular design works especially the Internal Authorization Process as detailed herein;
- (3) Hierarchy of relevant documentation (including drawings) of quality management system for managing and controlling design works including design works of Subcontractors of any tier to avoid conflicts in the design submissions;
- (4) A list of general procedures to be applied to manage and control the quality of the design works and
- (5) The Functional procedures which maintains the Design Team in whole Contractor's organization to carry out the design works strictly in compliance with the Employer's Requirements and for the benefit of the Employer.

11.6 DESIGN REVIEW

11.6.1 Contractor's Design Team

- (1) The Contractor shall be responsible for the design of the Works and shall ensure his design is correct / accurate and in compliance with the Employer's Requirements and Specifications contained in the Contract. The Contractor shall ensure that all the completed Works are in line with his design and concurrently in compliance with the Employer's Requirements and safe.
- (2) The Contractor shall establish his dedicated design team referred to as the Design Team in his organization to ensure that his design works are strictly in compliance with the Employer's Requirements and Specifications and for the benefit of the Employer. On the other hand, to clarify the responsibilities and the authorities, the Contractor shall also establish a Construction Team independent of the Design Team; thereby the Contractor shall be responsible for assuring the quality of the Works as required in the relevant Particular Specifications.

11.6.2 Senior Design Engineer

- (1) The Contractor shall appoint a fully qualified and experienced full-time Senior

Design Engineer whose credentials has been submitted by the Contractor as part of his Technical proposal and has been accepted by the Engineer. The Senior Design Engineer shall act as a representative of Design Team and shall be wholly responsible for the Contractor's design Works.

- (2) The Senior Design Engineer shall be responsible for establishing, implementing, maintaining and recording Design Quality Assurance Plan.
- (3) The Senior Design Engineer shall be able to discharge his duties without any hindrance or constraint. Accordingly, the Senior Design Engineer and his team shall strictly adhere to ISO 9001–Quality Assurance System of the Contractors, as consented by the Engineer so as to ensure that his decisions and activities with regard to the Quality Assurance be checked and monitored by the internationally acknowledged system. The Contractor shall identify the personnel to whom the Senior Design Engineer shall be responsible and reports to and seek the consent of the Engineer for the same. The Contractor shall also identify personnel necessary under the supervision of the Senior Design Engineer to furnish the Design Team to fully function as intended in the requirements herein and seek the consent of the Engineer. In addition, the Contractor shall make available any such resources that are necessary to ensure the effective implementation of the quality management system.
- (4) The Contractor shall submit details of the authority and responsibility of the proposed Chief Design Engineer for review and consent by the Engineer, as part of the Project Quality Assurance Plan.

11.7 INTERNAL AUTHORIZATION PROCESS

11.7.1 All design submissions including Detailed Design, Construction Design, As-Built Documents shall include a valid "Design Certificate" as per Chapter-15, Appendix-3: "Design Certificates" duly signed by Chief Design Engineer in the Contractor's Design Team and Contractor's authorized Representative, thereby demonstrating that:

- (1) Design of the Permanent Works complies with the relevant Particular Specifications
- (2) In-house checks have been undertaken to conform the completeness, adequacy and validity of the design as per all the quality assurance procedures
- (3) All the required approvals has been obtained
- (4) Design has been performed and finalized utilizing the skills of a professionally qualified, competent and experienced designers and engineer(s)

11.7.2 The Contractor shall fully verify the respective design outputs as a set of submissions through the Internal Authorization Process by signing and attaching "Design Certificate" as the covering document. Forms, further details and other requirements of the contents of the respective Design Package are detailed in Employer's Requirement, Part 2, Section VI, Volume I,

11.7.3 After receiving the "Notice of No Objection' or "Notice of No Objection with Comments" in respect of the Construction Design, all the original paper drawings in respect of Working Drawings shall be endorsed as "Good For Construction" by Senior Design Engineer before issuing it to the Site or submitting to the Engineer for his endorsement as specified in Chapter-3: "Project Planning & Management".

- 11.7.4 In case the Contractor contemplates any change in the design already submitted to the Engineer for approval and / or for the design and drawings for which the Contractor has already received 'Notice Of No Objection', it shall be dealt as per the provisions of Design Review Procedure detailed in the preceding para.

11.8 SITE QUALITY PLAN

11.8.1 On-site Quality Management Provisions

The Contractor shall prepare a Site Quality Plan separately for the construction and installation of Works. The Site Quality Plan shall include the comprehensive on-site quality management in compliance with the Employer's Requirements under the Contract and shall, without limitation, define as follows:

- (1) Organization of the Contractor's staff directly responsible for the day-to-day management of the construction and installation activities to execute the Works on the site;
- (2) Allocation of responsibilities and authorities given to identified personnel or Subcontractors for particular construction and installation of the Works;
- (3) Hierarchy of relevant documentation (including drawings) of quality management system for managing and controlling construction and installation of the Works including construction and installation works of Subcontractors of any tier to avoid conflicts in the execution of the Works; and
- (4) A list of sequences to be applied to manage, control and record the construction and installation of the Works.

11.8.2 On-site inspection and test provisions

- (1) The Contractor shall also prepare onsite inspection and test plans to manage, control and record any test and inspection activities. The Inspection and Test Plans shall be established for particular activities which require inspection and/or test to meet the quality level required in the Employer's Requirements and as included in any form in the Contractor's design and the Works Specifications. It shall cover the requirements of International Standards ISO 9001 and in compliance with the Contract
- (2) The Contractor shall prepare and maintain a full list of the all Inspection and Test Plans needed under the Contract with submission status and review status and shall submit to the Engineer for his consent.
- (3) Each Inspection and Test Plan for the particular activity shall define, without limitation:
 - (i) Scope of activities covered by the plan;
 - (ii) A sequence of the Work related to the activities in the scope;
 - (iii) Personnel responsible for undertaking the inspections and/or tests and the personnel responsible for certifying the inspections and tests;
 - (iv) Inspections and/or test methods, their frequency, and/or reference material to the relevant standard of the inspections and/or the tests;

- (v) Compliance criteria of the inspections and/or tests with clear descriptions of the quality hold point and the quality control point;
- (vi) Documents to be used for reporting the results of the inspections and/or tests with sample documents incorporated into the Plan; and
- (vii) Methods of record keeping and document storage as to the locations to be maintained / stored and procedures for those to be acknowledged / filed.

11.9 MANUFACTURING MANAGEMENT AND QUALITY ASSURANCE PLANS

11.9.1 Manufacturing Quality Management Provisions

The Manufacturing Quality Plans shall define the Contractor's management structure and quality management system for the manufacturing process of the key items of the Works and for the items as requested by the Engineer. Separate Manufacturing Quality Assurance Plans shall be prepared for each manufactured item and submit them to the Engineer for consent. Each Manufacturing Quality Assurance Plans for manufacturing process management shall be established in compliance with the Employer's Requirements under the Contract and shall, without limitation, define as follows:

- (1) Scope of activities and items covered by the plan;
- (2) Organization of the Contractor and/or the Subcontractor responsible for the day to day management of the manufacturing process of the items;
- (3) Allocation of responsibility and authority given to identified personnel for the day to day management of the manufacturing process with particular reference to the supervision, inspection and testing of the process and manufactured items;
- (4) Specific methods including handling and management of the manufacturing process and manufactured items, including but not limited to the following:
 - (a) Particulars of the material to be used in the manufacturing process;
 - (b) Monitoring and management of manufacturing process in compliance with the approved drawings and specifications;
 - (c) Identification or referencing procedures for traceability of the manufactured date;
 - (d) Identification of the inspection/ test status of the material and the final manufactured item;
 - (e) Disposition of nonconforming material and the manufactured item;
 - (f) Handling, storage, packaging, preservation and delivery of the manufactured item; and
 - (g) Procedure of monitoring and recording of the ordering and delivery of the item.

11.9.2 Manufacturing inspection and test provisions

- (1) The manufacturing inspection and test plans to be prepared by the Contractor shall cover all the requirements of Tests: Type Tests (wherever applicable), Factory Acceptance Tests, site checks and tests, Installation Tests, System Acceptance

Tests and tests on completion as required.

- (2) In addition to the inspection by the Contractor and the Engineer, the Employer may, at his own cost, depute its representative or nominate any other independent inspection agency for supervising and monitoring the manufacturing process at the factory. In order to facilitate such an inspection, the detailed production/manufacturing plan shall be provided by the Contractor to the participants of the inspection as well as to the Engineer at least six weeks in advance of the commencement of the manufacturing process along with the description of mandatory specifications and tests proposed during the manufacturing process and the tests intended to be conducted on the finished product along with codal permitted tolerances.

11.10 ON-SITE INSPECTION PLAN FOR RESOURCES PROCUREMENT

- 11.10.1 The Contractor shall establish On-site Inspection Plan for Resources Procurement for managing, monitoring and recording the on-site receipt of general construction resources including all construction material, labour forces, and works and services delivered to the Site and the Temporary Facilities e.g. assembly and tests on assemblies prior to installation, their stacking and storage etc. in the Work Areas.
- 11.10.2 Onsite Inspection Plan for resources procurement to be prepared by the Contractor shall cover all the requirements.

11.11 TESTS

- 11.11.1 Tests to be carried out for quality assurance purposes shall be as specified in the Particular Specifications Volume 2 to Volume 5 and as per the Quality Assurance Plan / Inspections and Test Procedures duly approved by the Engineer.
- 11.11.2 The Contractor may employ other tests to further ensure the quality of the Works. In such a case, the Contractor shall be responsible for obtaining prior approval from the Engineer by submitting the test plans with regard to the application of the tests as part of the Project Quality Assurance Plan or its sub-plans.

11.11.3 Test Plan and Procedure

The Contractor shall submit all test plans and procedures for review by the Engineer at least 30 days prior to conducting any test together with the exact time and date of such tests. Test procedures shall show the following unambiguously but shall not be limited to:-

- (1) List of resources required to carry out the various testing activities and their capabilities.
- (2) Date on which the Contractor proposes to conduct each of these listed tests;
- (3) nature and purpose of test;
- (4) extent of testing covered by each submission;
- (5) method of testing and tests requirements with the relevant standards;
- (6) relevant drawing and document (or modification) status;
- (7) location of testing;

- (8) test parameters to be measured with the relevant standards;
- (9) constraints to be applied during the test with the relevant standards;
- (10) defined pass/fail criteria with relevant standards;
- (11) format of the raw data for processing by the Contractor; and
- (12) Test instrumentation and test circuitry to be used during the test with the relevant standards.

11.12 SOFTWARE QUALITY ASSURANCE PROGRAM (SQAP)

11.12.1 Each software suppliers for Contractors and System Suppliers shall assure software dependability by establishing and implementing a Software Quality Assurance Program (SQAP). The SQAP will:

- (1) Identify, monitor and control all technical and managerial activities necessary to ensure that the software achieves the required quality.
- (2) Ensure that an audit trail is established which enables verification and validation that the SQAP activities were effectively completed.

11.12.2 Each software supplier shall provide evidence that the SQAP activities were carried out, by submitting the documents in given in the Table below.

Documentation	EN Standard
Software Project Management Plan	EN 50128 section 5
Software Quality Assurance Plan	EN 50128 section 6.5
Software Configuration Management Plan	EN 50128 section 6.5, 6.6
Software Verification and Validation Plan	EN 50128 section 6.2, 6.3
Software Requirements Specification	EN 50128 section 7.2
Software Design Description	EN 50128 section 7.3, 7.4
Software Verification and Validation Report	EN 50128 section 6.2, 6.3
Traceability	EN 50128 section 5.3.2.7,D.58

Table 1: Software Quality Assurance Plan Requirements

11.13 QUALITY AUDITS

11.13.1 The Contractor shall carry out quality audits on the Works at quarterly intervals or at such other intervals as the Engineer may require, to ensure the continuing suitability and effectiveness of the quality management system. Reports of each such audit shall be submitted promptly to the Engineer for review.

11.13.2 The Contractor shall submit, for review by the Engineer, details of the authority, qualifications and experience of personnel assigned to quality audit activities before carrying out quality audits.

11.13.3 The Engineer may require quality audits on the Contractor and his Subcontractors to be carried out by his representative or the Employer's staff. In such case, the Contractor shall afford to such auditors all necessary facilities and access to the activities and records to permit this function to be performed.

- 11.13.4 Upon receipt of corrective action request (CAR) or similar document issued by the Engineer as a result of quality audits, the Contractor shall promptly investigate the matter and submit the proposed corrective and preventive actions within 14 days to the Engineer for review. The Contractor shall take timely corrective and preventive actions to rectify the matter and to prevent re-occurrence. Evidence to demonstrate effective implementation of corrective and preventive actions shall be submitted by the Contractor to the Engineer for review.

11.14 NOTIFICATION OF NON-CONFORMITIES

- 11.14.1 If, prior to an issue of the Taking-Over Certificate for the Works or the relevant Section, the Contractor proposes to repair any item of the Works which does not conform to the requirements of the Contract, the Contractor shall immediately submit for review by the Engineer of such proposal and supplying full particulars of the nonconformity and, if appropriate, of the proposed means of repair.
- 11.14.2 If the Engineer issues nonconformity report or similar documents to notify the Contractor of any item of the Works which does not conform to the requirements of the Contract, the Contractor shall promptly investigate the matter and within 14 days of notification by the Engineer, submit to the Engineer for review the remedial measures and necessary actions to be taken to rectify the item and to prevent re-occurrence.
- 11.14.3 The Contractor shall maintain and update a nonconformity register to indicate the status of all nonconformities which are identified by the Engineer/ and or the Contractor. The Contractor shall submit the register for review upon request by the Engineer.

11.15 MONTHLY PROGRESS REPORT ON QUALITY MANAGEMENT SYSTEM

- 11.15.1 The Contractor shall continuously monitor the performance of the quality management system and shall include the same in each Monthly Progress Report.
- 11.15.2 The Contractor shall provide and maintain, at all stages of the Works, a quality control register(s) to identify the status of inspections, sampling and testing of the work and all certificates. Such register shall be updated by the Contractor to show all activities in previous months and shall reach the Engineer's office before 7th working day of each month. Each register shall:
- (1) List the certificates received for each batch of goods and material incorporated in the Works and compare this against the certification required by the Contractor and the Contractor's quality plans;
 - (2) List the inspection and testing activities undertaken by the Contractor on each element or segment of the Works and compare these activities against the amount of inspection and testing required by the Contract and the Contractor's quality plans;
 - (3) Show the results of each report of inspection and/or test and any required analysis of these results and compare these results against the pass/fail criteria;
 - (4) Summaries any actions proposed by the Contractor to overcome any nonconformity; and

- (5) The Engineer shall submit the same to the Employer along with his observations / comments before 15th working day of each month.

11.16 QUALITY RECORDS

The Contractor shall ensure that all the quality records as objective evidence of the implementation of the quality management system are properly indexed, filed, maintained, updated and securely stored.

(End of Chapter-11)

CHAPTER-12: RELIABILITY, AVAILABILITY, MAINTAINABILITY & SAFETY (RAMS)

12.1 GENERAL

- 12.1.1 The Reliability, Availability, Maintainability, & Safety activities shall be undertaken throughout the whole course of the project as an Integral part of System Assurance in order to demonstrate in a logical, progressive and traceable manner that:
- (1) The objectives and requirements of the project have been satisfied.
 - (2) All systems and components of the works are defined appropriately with verifiable performance benchmarks.
 - (3) Proper designs, Calculations and Simulation tools have been used.
 - (4) The work has been executed by suitably competent people.
 - (5) The designs have been verified by the competent authorities.
 - (6) Any manufacturing, construction, installation, testing and commissioning works associated with the project have been validated.
 - (7) Safety related aspects of the systems have been identified, analyzed and mitigated such that residual risks have been demonstrated to be as low as reasonably practicable for all project stages.
 - (8) RAMS requirements of the Systems have been identified, apportioned to various subsystems and elements of the works and the associated designs for these have been demonstrated to be capable of meeting their allocated performance targets.
- 12.1.2 The activities shall apply to software design as well as hardware and hardware application designs.
- 12.1.3 The Contractor shall co-ordinate results of analysis with each engineering discipline, particularly as the results affect engineering and hardware development.
- 12.1.4 The Contractor shall make recommendations for reengineering or modifications necessary to assure compliance with specified requirements including redundancy, utilization of high reliability components, built-in self-diagnostics and "self-healing"; utilization of in-service status displays to enhance fault isolation and test; easy accessibility and quick disconnect connectors; and, the use of mechanical keying to reduce errors during installation and repair.
- 12.1.5 The Contractor shall document instances where evaluations or analyses indicate an unresolved problem area and formulate appropriate recommendations as well as maintain records, which show that follow-up action has been taken to resolve the problem.
- 12.1.6 The Contractor shall maintain documentation of System Assurance throughout the engineering and make it available for examination.

12.2 RELIABILITY, AVAILABILITY, MAINTAINABILITY AND SAFETY (RAMS) PLAN

- 12.2.1 The RAMS Plan shall be maintained as a live document and updated as necessary throughout the duration of the Project.
- 12.2.2 The RAMS plan shall define the Contractor's approach on systematic compliance to System Requirement Specifications, procedures and schedules for conducting the Reliability, Availability, Maintainability and Safety Engineering. Human Factors Engineering is an integral part of System Assurance and shall be considered and reflected within the System Assurance Plan.
- 12.2.3 RAMS Plan shall describe the organization, resources and procedures that will be established to manage system assurance activities. It shall clearly define the responsibilities of individual personnel directly associated with the system assurance activities and implementation of the program.
- 12.2.4 This RAMS Plan will describe the RAM and Safety Assurance activities throughout the project lifecycle, comprising:
- (1) Preliminary Design
 - (2) Detailed Design
 - (3) Final Design
 - (4) Manufacturing and Production
 - (5) Testing and Commissioning
 - (6) Operation
- 12.2.5 The RAMS Plan shall describing the procedures to perform the specific RAMS tasks necessary to meet Reliability, Availability, Maintainability and Safety requirements.
- 12.2.6 The RAMS Plan shall include application of the relevant standards, norms, regulations, instructions and the Employer's Requirements/Specifications.
- 12.2.7 The Contractor shall liaise with the Employer/Engineer to establish a comprehensive program of work that will encompass all the requirements of this plan in a time scale that enables the construction, installation, test, commissioning, putting to work and warranty monitoring to be undertaken in good time to meet the overall time scales of the project.
- 12.2.8 The Contractor shall submit a compliance matrix in the RAMS Plan with all phases mentioned above and tasks to be performed and the deliverables to be submitted. These requirements shall also be applied to sub-contractors.

12.3 COMPLIANCE MANAGEMENT

- 12.3.1 A compliance management process shall be established and maintained for the duration of the Project to:
- (1) Import all RAMS requirements from the Project documents and ensure compliance to Technical Specifications and System Requirements Specifications.
 - (2) Import design requirements and specifications from each stage of design as they are developed and assess the impact of any changes in these.

- (3) Provide traceability to demonstrate that high level and low level design requirements and specifications have been verified that they satisfy the RAMS requirements.
- (4) Provide traceability of review comments made and the associated responses and follow up actions.
- (5) Provide traceability of non-conformances and follow up actions required to address them.
- (6) Provide traceability of validation of testing and commissioning results against RAMS requirements or design requirements and specifications.
- (7) Provide summary reports on key status items including, but not limited to requirements not yet satisfied and incomplete or missing verifications or validations.

12.4 VERIFICATION & VALIDATION

12.4.1 Verification and validation activities shall be undertaken to show in a logical, progressive and traceable manner that the:

- (1) The designs satisfy the RAMS requirements.
- (2) The completed works that have been subjected to testing and commissioning indeed demonstrate that they meet the RAMS requirements.

12.4.2 Verification & Validation shall be carried out preferably by an engineering team who are independent from those carrying out the design.

12.4.3 All the equipment & components/ Products used in the Contract shall be approved only when the Engineer has been satisfied as to their strength, reliability and suitability. To assist the Engineer in this respect, the Contractor shall furnish on request, performance data, references to completed works and any other relevant information together with samples of materials for approval.

12.4.4 Verification methods shall include one or more of the following:

- (1) Analysis of design
- (2) RAM studies
- (3) Design safety studies
- (4) Simulations
- (5) Calculations
- (6) Benchmarking against international best practice where appropriate, and
- (7) Other methods as appropriate.

12.4.5 Records of all verification and validation activities shall be kept and shall be traceable through the Compliance Management Process.

12.5 RAMS ORGANIZATION

12.5.1 The RAMS organization of the contractor shall have dedicated RAM and Safety Managers who shall have implemented the RAMS strategy for the relevant system in at

least one Metro/railway project environment.

12.5.2 Alternately, the Contractor can engage the services of a RAMS consultant to manage the entire scope of the RAMS work.

12.5.3 In the event that Employer engages the services of an Independent Assessor, the Contractor shall coordinate with the Independent Assessor and provide all documentation requested.

12.6 RELEVANT STANDARDS

12.6.1 The RAMS Assurance activities shall comply with the requirements of EN 50126: Railway Application – The specification and demonstration of reliability, availability, maintainability and safety (RAMS) or the equivalent IEC 62278 standards.

12.6.2 RAMS assurance activities related specifically to communications, signalling and processing systems shall comply with the requirements of:

- (1) EN 50128: Railway Application – Communications, signalling, and processing systems – Software for Railway control and protection Systems.
- (2) EN 50129: Railway Application – Communications, signalling, and processing systems – Safety related electronic systems for signalling or the equivalent IEC 62279 and IEC 62280 standards.

12.6.3 Apart from the above mentioned mandatory standards, it is recommended to follow the below mentioned standards of the latest edition.

- (1) IEC 61025: Fault Tree Analysis
- (2) IEC 61078: Analysis techniques for dependability: Reliability block diagram and Boolean methods
- (3) IEC 60812: Analysis techniques for system reliability – Procedure for failure modes and effects analysis (FMEA)
- (4) MIL-STD-1629A: Procedure for performing a Failure Mode Effect and Criticality Analysis (FMECA)
- (5) MIL STD 471-A: Maintainability Verification / Demonstration / Evaluation
- (6) IEC 60300-3-5: Dependability management - Part 3-5: Application guide – Reliability test conditions and statistical test principles.
- (7) IEC 60300-1: Dependability management — Part 1: Dependability management systems
- (8) IEC 60300-2: Dependability management - Part 2: Guidelines for dependability management

12.7 SYSTEM RAM MANAGEMENT

RAM management activities shall be undertaken in order to demonstrate in a logical, progressive and traceable manner that the works satisfy the requirements of the project pertaining to RAM.

12.7.1 RAM Management Activities

(1) Design Phase - The RAM Management activities shall include:

- a. Preparation of RAM Plan
- b. Develop RAM allocations for subsystems, assemblies, and equipment.
- c. Perform Reliability, Maintainability and Availability analyses at the Preliminary Design phase.
- d. Perform detailed Reliability, Maintainability and Availability analyses and Prediction at the Final Design phase.
- e. Perform FMECA
- f. Integrate RAM design and analysis results into test planning, maintenance planning, maintenance manuals, and operating manuals.
- g. Establish FRACAS

(2) Construction and Installation Phase - The RAM activities shall include:

- a. Updating of Reliability, Maintainability and Availability analyses and Prediction
- b. Updating FMECA
- c. Preparation of Reliability, Maintainability and Availability Demonstration Plans

(3) Testing, Trials and Warranty Phase - The RAM activities shall include:

- a. Perform RAM Demonstration.
- b. Execute a Failure Reporting and Corrective Action System (FRACAS).
- c. Provide all necessary reports and documentation for tracking by the V&V process.

12.7.2 RAM Analysis and Prediction

- (1) Contractor shall undertake a RAM Analysis and Prediction of the system. The RAM Analysis will provide an initial and broad assessment of all known service failure and service interruption modes for top-level events such as minor, major, and immobilizing service interruptions.
- (2) The purpose of the RAM Analysis is to ensure that the potential service failure modes, causes, and mitigations are well understood by all parties as the design, integration, fabrication, testing, and acceptance activities move forward.
- (3) Reliability shall be assessed in terms of the MTBF/MTBSAF. The assessment will have a bottom up approach commencing from the LRU level and proceeding up to the sub-system and system level. MTBF/MTBSAF is the predicted elapsed time between inherent failures/service affecting failures of a system during operation.
- (4) The RAM Analysis shall also be used to identify and select service failures for in-depth assessment in the Fault Tree Analysis (FTA).
- (5) The Contractor will provide a first iteration of the Reliability Prediction Report for employer's approval. Reliability Prediction Report will be periodically updated until the task is concluded.

- (6) Reliability Predictions shall be conducted at the appropriate level of detail to ensure adequate reliability and fulfilment of the specifications and RAM requirements. This may entail conducting an analysis at the subsystem, assembly, lowest replaceable unit (LRU), block, element, or component level, and may require combining differing analyses from different levels for a single subsystem.
- (7) Reliability Predictions shall be based on existing performance records, reliability test data, warranty and operating data, and reliability prediction analyses from previous similar projects. For equipment with incomplete or inconclusive operating, failure, and/or reliability demonstration data, the equipment supplier will develop a reliability prediction using other information sources, such as, MIL-HDBK-217F Notice 2, Non electronic Parts Reliability Data (NPRD), Manufacturer test data, or any other well-established industrial reliability prediction databases.
- (8) The reliability predictions shall be subject to confirmation during the Reliability Demonstration Test.

12.7.3 Failure Mode, Effects, and Criticality Analysis (FMECA)

FMECA is a systematic procedure for the analysis of a system to identify the probability of occurrence and severity of the potential failure modes, their respective causes and immediate and final effects on systems performance (performance of the immediate assembly and their entire system) and to provide an input to mitigating measures to reduce risk.

- (1) FMECA shall be performed and updated at different project stages until the task is concluded. The FMECA will be intended to:
 - a. Undertake decomposition of the System, Sub-systems from the highest level till the LRU level.
 - b. Provide the lowest-level analysis of failures and failure effects on the system and its subsystems and equipment.
 - c. Identify weaknesses in system hardware and software design and analyse failure modes and effects, particularly for when these details are not established by historical records of equipment operation.
 - d. Use inductive logic in a "bottom up" system analysis. This approach begins at the lowest level which is the Lowest Replaceable Unit (LRU) of the equipment under analysis and traces consequences up to the system level to determine the end effects on sub-system and system performance.
 - e. Identification of single failure points critical to proper system performance.
 - f. Provide early visibility into potential system interface problems.
 - g. Perform Criticality Analysis (CA) of the list of possible failure modes by ranking them in accordance to their risk which is dependent on the probability of occurrence and severity of the failure. The CA will allow prioritization of mitigation measures.
- (2) The purpose of FMECA shall be to identify:
 - a. Those failures which have unwanted effects on safety
 - b. Those failures which have unwanted effects on system operation

- c. Those failures which have unwanted effects on overall reliability
- d. To allow improvements of the systems safety
- e. To allow improvements of the systems reliability
- f. To allow improvement of the systems maintainability
- g. To allow improvements in the systems availability

12.7.4 Reliability Critical Item List (RCIL)

- (1) The contractor shall perform Reliability Analysis to identify Reliability Critical Items List (RCIL). Reliability critical items are those items that have a significant impact on product reliability, performance, safety, availability or life cycle cost. Identifying and controlling critical items is imperative since these parts are often the parts that drive unreliability.
- (2) A critical item output report will be submitted to ensure that reliability critical components were identified and controlled; reliability predictions and an FMECA were performed. Critical items will be identified via the failure rates noted in the prediction and by the single failure point analysis performed in the FMECA.

12.7.5 Maintainability Analysis and Predictions

- (1) The contractor shall perform maintainability analysis to dovetail the maintenance requirements so as to ensure the performance of the system as a whole.
- (2) Maintainability shall be assessed in terms of MTTR. The MTTR shall include the diagnostic time, active repair / replacement time and adjustment / testing time, including software re-boot, up to the point the system is restored to full functionality.
- (3) The MTTR does not include the time taken for designated personnel to arrive on site (access time) to begin local diagnostic activities or the time taken for the replacement parts to be delivered at site.
- (4) In all availability calculations the following access times shall be assumed:
 - a. 30 minutes for train-borne equipment.
 - b. 1 hour for track side electrical equipment.
 - c. 30 minutes for electrical equipment located in equipment rooms.
 - d. 1 hour for signalling equipment.
 - e. 2 hours for telecom equipment
- (5) In the maintainability analysis, the contractor shall lay special emphasis on features such as Built-in-Test (BIT) and fault isolation, acknowledging the criticality of these features to the effectiveness of system testability and maintainability. Built-in-Testing goals should be established that provide the attainment of highest fault coverage detection and isolation to the Lowest Replaceable Units (LRUs).
- (6) The contractor shall perform Maintainability Analysis to identify Maintainability Critical Items List (MCIL). The maintainability critical items are those items that have a significant impact on product maintainability, performance, availability or life cycle cost. Identifying and controlling critical items is imperative since these parts are often the parts that drive system downtime.

12.8 SYSTEM SAFETY MANAGEMENT

12.8.1 Principle of Safety Management

- (1) System Safety Management activities shall be undertaken to demonstrate in a logical, progressive and traceable manner that the works satisfy the safety requirements of the Project.
- (2) The basic principle of safety management shall be that all reasonably foreseeable hazards are identified and action then taken for each hazard as follows:
 - a. Risks arising from the hazard shall be assessed.
 - b. If the risk is broadly acceptable no further action shall be required, otherwise measures shall be taken to reduce or eliminate the risk.
 - c. Each of these measures shall become a 'safety requirement' and all safety requirements shall be subject to verification and validation processes to show that they have been met by design and later by practical tests.
 - d. The mitigation, verification and validation status of all hazards shall be recorded in the Hazard Log.

12.8.2 System Safety Plan

The System Safety Plan shall be developed in accordance with EN 50126 and shall include but not be limited to the following subjects:

- (1) Safety policy;
- (2) Risk acceptance criteria;
- (3) Risk management and Principles;
- (4) Hazard Analysis and Hazard Log;
- (5) Design safety studies; and
- (6) Management of safety during integrated testing, trials, and commercial operation.

12.8.3 Safety Policy

The proposed approach and commitment to safety shall be specified in a statement of safety policy endorsed by the submitter's senior management and this statement shall be included in the System Safety Plan.

12.8.4 Hazard Analysis

- (1) Hazard analysis shall be carried out to:
 - (a) Identify and record all reasonably foreseeable hazards associated with all phases of the Works;
 - (b) Assess the risk that each hazard represents to this operation; and
 - (c) Re-assess the risk after application of the proposed mitigation.
- (2) Where it is not reasonably practical (based on good practice or application of the ALARP principle) to eliminate hazards at the design stage, risk assessments shall be carried out to ensure that the risks associated with residual hazards are in order of precedence:

- (a) Minimized through mitigation measures at the design stage;
 - (b) Mitigated through special construction, installation and testing and commissioning processes; and
 - (c) Mitigated through operations and maintenance procedures.
- (3) Additional mitigation measures shall be proposed as required until such time as the residual risk is assessed to be 'as low as reasonably practicable'.
- (4) The results of the hazard analysis shall be recorded in a Hazard Log in a form that can be used to track progress in the implementation of mitigating actions and provide an easily accessible reference for the future Operator of all actions taken with respect to any hazard.

12.8.5 Primary hazards for Preliminary Hazard Analysis (PHA)

- (1) The PHA shall take into account, but not be limited to, the following primary hazards:
- (a) fire including:
 - (i) smoke asphyxiation;
 - (ii) hot works; and
 - (iii) explosion;
 - (b) impact including:
 - (i) collision;
 - (ii) derailment;
 - (iii) falling objects;
 - (iv) flying objects;
 - (v) sharp objects;
 - (vi) slipping, tripping and falling;
 - (c) electrocution;
 - (d) other hazards including:
 - (i) environmental;
 - (ii) flooding;
 - (iii) noxious fumes;
 - (iv) suffocation;
 - (v) entrapment; and
 - (vi) burns.
- (2) The PHA shall take into account the various types of operating mode (i.e. normal, degraded and emergency) and the operating scenarios during which all types of hazards might exist including, but not limited to:
- (a) freight service;
 - (b) evacuation; and

- (c) maintenance.
- (3) The PHA shall take into account the how each type of hazard might arise including, but not limited to:
 - (a) inappropriate design or specification;
 - (b) equipment failure;
 - (c) installation error;
 - (d) improper action (accidental or deliberate);
 - (e) inaction (unintentional or intentional); and
 - (f) External influence.
- (4) The PHA will be followed with the following detailed hazard analysis:-
 - (a) Sub System Hazard Analysis (SSHA)
 - (b) Interface Hazard Analysis (IHA)
 - (c) Operating and Support Hazard Analysis (O&SHA)
- (5) The hazard analysis will be supported by following assessment methods:
 - (a) Failure Mode, Effects and Criticality Analysis (FMECA)
 - (b) Fault Tree Analysis (FTA) of top level hazard scenarios.

12.8.6 Design Safety Studies and Report

- (1) The hazard analysis process shall identify the need for Design Safety Studies and the Hazard Log shall record the results of each of these Design Safety Studies.
- (2) Design Safety Studies shall be undertaken for system and subsystem elements that are considered to be safety critical and that require hazard analysis to a greater level of detail than that applied at an overall system wide level.
- (3) Design Safety Studies shall specifically refer to hazards arising from:
 - (a) normal operations including maintenance;
 - (b) degraded modes of operation;
 - (c) emergency situations; and
 - (d) The effectiveness of mitigation proposed for natural catastrophes.
- (4) The Design Safety Studies shall take account of:
 - (a) methods of operation;
 - (b) RAM considerations;
 - (c) anticipated likely maintenance regimes and their sustainability in Commercial Operation;
 - (d) anticipated competence levels of personnel in Commercial Operation;
 - (e) software security (disabling of unauthorized access to operating systems, protection against intrusive attacks, loss of password integrity, etc.); and
 - (f) Other human factors including but not limited to those identified in ergonomic studies.

- (5) Design/Systems Safety Studies and the Report shall demonstrate, as a minimum, the following requirements:-
- (a) That the overall risk criteria for the Works have been addressed satisfactorily at the Detailed Design stage and that the Detailed Design proposals are mutually compatible with such risk criteria.
 - (b) That all Safety Critical systems have been identified at the Detailed Design stage and the apportionment of risk factors between the major systems and sub-systems support the overall safety criteria approved in the "System Safety Plan".
 - (c) That the results of the Design Safety Studies have been incorporated into the design, and shall be carried forward into the Final Design, manufacturing and installation processes.
 - (d) That where management by operating and/or maintenance procedure or other management control measures have been identified during the "Design Safety Studies", auditable methods by which such measures shall be introduced into operating/maintenance provisions have been established.
 - (e) That robust processes have been implemented to validate the Safety Critical aspects of software design.
 - (f) That processes for assessing the potential safety impact of design changes exist.
- (6) A Design Safety Studies and Report shall be submitted at the completion of the design stage to confirm that all safety related aspects of design have been properly addressed and comprehensively verified.

12.9 RAM DEMONSTRATION

12.9.1 Reliability Demonstration

- (1) Contractor and System Supplier shall perform a Reliability Demonstration to verify that the system meets the required reliability performance requirements when:
- (a) Scheduled maintenance is performed in accordance with approved Maintenance Plan and Maintenance Manuals, and
 - (b) Systems are operated within the environmental limits described in the Design documents.
- (2) The demonstration of the system shall continue for a period of 24 months. If at the end of the 24 month test period the equipment has not met the reliability requirements, the System Supplier will implement design changes or modifications, as needed, to meet the reliability requirements. The test duration will be extended to ensure that the changes made result in achieving the requirements.
- (3) Contractor shall submit a RAM Demonstration Test Plan before the Final Design Review. The plan will address the following to illustrate compliance with the reliability requirements:
- (a) Plan schedule and period

- (b) Identification of necessary facility, resources, support equipment, and staff for the demonstration
 - (c) RDT procedures and forms for recording and submitting data
 - (d) Success failure criteria for measuring reliability values for individual equipment items and subsystems
 - (e) Failure analysis of reported failures to identify the cause and need for corrective action
 - (f) Establish a Failure Review Board (FRB) to meet with Employer, as required, to determine the need and depth of failure analyses
 - (g) Change control procedures for implementing design changes
 - (h) Format and location of test records, test logs, and data records
 - (i) Final conclusion and report for the demonstration.
- (4) The employer will approve the RAM Demonstration Plan and procedures before the trial commences.
- (5) The RAM Demonstration Procedures shall include all information necessary to ensure the successful, accurate and safe performance of the demonstration testing. The RAM Demonstration Procedures will include, as required:
- (a) Safety Precautions
 - (b) Identification of the reliability performance parameters that are verified by the test
 - (c) Scope of test
 - (d) Test equipment required, if any.
 - (e) Personnel required
 - (f) Any special conditions required, including condition of the equipment under test
 - (g) Reference drawings or documents
 - (h) Clear pass/fail criteria
 - (i) Data sheets to record test results
 - (j) Raw data correlation procedures
- (6) RAM Demonstration Procedures shall address the following:
- (a) Each equipment failure reported during the RAM Demonstration will be classified as relevant or non-relevant failures by the Failure Review Board (FRB). The assessment will include all failures, whether occurring in or out of revenue service.
 - (b) A proposed procedure for corrective action shall be developed and included. The procedure will include proposed changes and appropriate supporting data. The procedure will identify a specific method for verifying the effectiveness of change(s).
 - (c) Preventive maintenance procedures specified for the equipment during the

RAM Demonstration phase will be performed by the maintainer in accordance with applicable Contract Terms and Conditions.

- (d) System suppliers shall maintain records which contain all the information necessary to calculate reliability performance for the system and major subsystems, and to verify satisfactory reliability requirements. System suppliers shall provide failure and reliability performance records to employer in hard copy and in an approved electronic format.
- (7) A chargeable failure in the RAM Demonstration is defined as any relevant failure that requires repair or replacement of any subsystem or vehicle component. Chargeable failures also include intermittent failures, unverified failures, and software failures.
- (8) Non chargeable failures in the RAM Demonstration are:
 - (a) Consumable items, except for those which are not achieving their specified life
 - (b) A failure occurrence in equipment of another subsystem, due to the primary failure
 - (c) A failure of the operator/maintainer to perform recommended preventive maintenance actions
 - (d) Vandalism or physical mistreatment at a human interface
 - (e) Failures due to an accident.
- (9) Contractor shall provide Weekly Failure Reports during the RAM Demonstration phase. The Contractor will submit the format and structure of the report to employer for review and approval at least three months before system commissioning begins.
- (10) Contractor shall submit Monthly Demonstration Test Reports to employer documenting the current and cumulative failure totals for the system equipment, comparing the totals to the reliability requirements.
- (11) All reports shall clearly identify the system being tested, the date(s) of test, any conditions that may have affected results, and pass/fail status. The test record sheet shall be signed by the personnel performing and witnessing the test. All measured data shall be recorded in numeric form on the reports (not just checked off as acceptable). For the RDT, this means that the applicable support data for the RDT must be included with the RDT Report.

12.9.2 Availability Demonstration

- (1) The Contractor shall demonstrate the specified Availability during Service Trials and during the DLP. The Availability Demonstration Testing (ADT) shall be conducted on all Systems, subsystems and their interfaces.
- (2) In the event that the availability target is not achieved, the determination of availability achievement in the preceding six month period shall be continued at monthly intervals until the target is achieved.
- (3) In the event that the availability target is not achieved, the Contractor shall, at his own expense, take whatever action is deemed necessary to meet the availability requirement.

- (4) The contractor will submit the Availability Demonstration Test Report on completion of the demonstration testing.

12.9.3 Maintainability Demonstration

- (1) Contractor and equipment Supplier shall conduct a Maintainability Demonstration (MD) to establish the accuracy of task time estimates for the preventive and corrective maintenance tasks described in the applicable Maintenance Plan, Maintenance Procedures, and/or Maintenance Manuals. Contractor and equipment Supplier will perform the MD concurrent with the Engineer training program. Contractor and equipment Supplier will demonstrate selected servicing, preventive maintenance, troubleshooting, change out of components, corrective maintenance, and use of special tools where special emphasis, instruction, or proficiency is needed. The Engineer will notify equipment Suppliers which preventive and corrective maintenance tasks have been selected for the MD.
- (2) Maintainability Demonstration Test Plan shall be provided before the Final Design Review.
- (3) In the event that any maintainability target is not achieved, the Contractor shall at his own expense take whatever action is deemed necessary to meet the maintainability targets.
- (4) The contractor shall submit a Maintainability Demonstration Test Report on completion of the demonstration testing.

12.10 FAILURE REPORTING AND CORRECTIVE ACTION SYSTEM (FRACAS)

12.10.1 Purpose of FRACAS

Contractor shall provide a Failure Reporting and Corrective Action System (FRACAS) that supports requirements of the RAM Demonstration and Warranty Program. The contractor shall submit the FRACAS for employer's approval before the Final Design Review. Contractor will use a Failure Reporting, Analysis and Corrective Action System (FRACAS) to track and report on system failures. The FRACAS will consist of a set of data management tools for capturing and reporting on equipment incident data, and a set of procedures which use the data management tools. The FRACAS procedures:

- (1) Implement key project functions of reliability demonstration and warranty administration
- (2) Assess compliance of delivered equipment with requirements
- (3) Provide field and operating information to equipment and project design and analysis tasks
- (4) Assess the effectiveness of modifications to equipment in the field.

12.10.2 Where system failures indicate the possibility of a non-compliant design, the FRACAS process will consist of the following activities:

- (1) Communication of failure information from the operating authority to System Suppliers
- (2) Assessment of the failure conditions, impacts, and possible causes by the System Supplier Quality Assurance and Engineering departments, and by equipment

suppliers

- (3) Where appropriate, failure analysis by the equipment supplier
- (4) Corrective action by the equipment supplier
- (5) Once corrective action has been completed through field or factory action, verification by the System Supplier that the implemented solution is adequate and acceptable.

12.10.3 FRACAS Guidelines

- (1) A comprehensive FRACAS closed loop diagram is depicted as under :

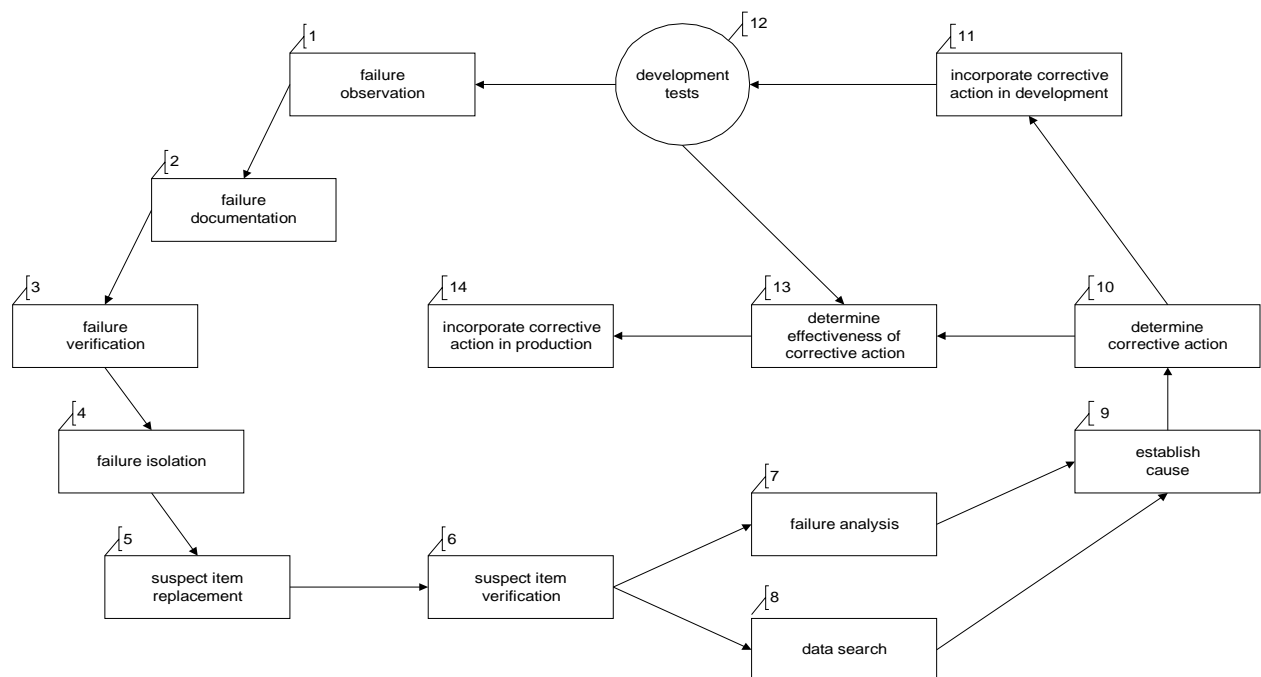

Figure 1: Generic closed-loop FRACAS

- (2) Key steps in FRACAS are as follows:
 - (a) Observation of failure
 - (b) Complete documentation of failure including all significant conditions which existed at the time of the failure
 - (c) Failure verification, i.e. confirmation of the validity of the initial failure observation
 - (d) Failure isolation, localization to the lowest replaceable defective item within the product
 - (e) Replacement of the suspect defective item
 - (f) Confirmation that the suspect item is defective
 - (g) Failure analysis of the defective item
 - (h) Data search to uncover other similar failure occurrences and to determine the previous history of the defective item and similar related items

- (i) Establishment of the root cause of the failure
- (j) Determination, by the design team, of the necessary corrective action, especially any applicable redesign
- (k) Incorporation of the recommended corrective action into development equipment
- (l) Establishment of the effectiveness of the proposed corrective action
- (m) Incorporation of effective corrective action into the equipment
- (n) The failure documentation should be augmented with the verification of failure (step c above), and verification that the suspect part did indeed fail (step f).

12.10.4 Failure Reporting Format

Failure Report Forms: All failures shall be recorded on a failure report form which shall contain as a minimum the following information:

- (1) Identification of the equipment, including nomenclature, serial number, manufacturer's part number and location;
- (2) Location of failure;
- (3) Individual who observed failure;
- (4) Operating time of each system including each shut-down and its cause;
- (5) Date and time of each incident;
- (6) Failure symptom/indication, mode, cause and effect;
- (7) Classification of the incident (relevant independent failure or dependent failure);
- (8) Corrective maintenance or operational procedures required to restore the System to operation;
- (9) Time to restore System to operation and active repair time; and
- (10) Circumstances of interest such as Environmental conditions and supply voltages.

12.10.5 Failure Database

12.10.5.1 The key to a successful FRACAS is its database. This is particularly important in establishing the significance of a failure. For example, the failure of a capacitor in a reliability growth test becomes more significant if the database shows similar failures during incoming inspection of the part and in any environmental tests performed. For this reason all available sources of data should feed the FRACAS.

12.10.5.2 The Contractor shall maintain the failure database throughout the execution of the Works. The FRACAS system along with the database shall be handed over to the Employer at the expiry of the Defects Notification Period.

12.11 ON-SITE TESTING AND INTEGRATED SYSTEM TESTING

General Requirements

The On-site Testing and Integrated System Testing shall demonstrate as a minimum the following requirements:

- (1) That the safety management organization to control the on-site Testing and Integrated System Testing is in place.
- (2) The testing procedures shall ensure that all the critical failure modes as identified during the FMECA / FMEA activity are addressed through proper test cases inclusion. A traceability matrix shall be developed such that these critical failure modes are traced back to the corresponding test cases. All failure modes shall be considered as critical failure modes unless the Contractor demonstrates by a sensitive analysis or other means that the impact of a failure mode on reliability and maintainability will be insignificant.
- (3) That the scope of activities to be carried out during the on-site Testing and Integrated System Testing period covers all Safety Critical functions and Safety requirements including those in the Hazard Log.
- (4) That the segregation of on-site Testing and Integrated System Testing activities from residual construction and installation activities shall be implemented.
- (5) That the procedures required to conduct on-site Testing and Integrated System Testing activities safely, including where necessary, the protection measures for any part of the Railway which may be in operation shall be implemented.
- (6) That the processes which are to be implemented to validate the Safety Critical aspects of software installation and testing shall be implemented.
- (7) That the processes required to assess the safety implications of the results of tests and inspections carried out during the periods of on-site Testing and Integrated System Testing activities shall be implemented.
- (8) That the processes required controlling and validating the safety implications of modifications carried out during the period of on-site Testing and Integrated System Testing activities shall be implemented.
- (9) That the arrangements which are to be utilized to record, report and investigate accidents and incidents together with the systems necessary to formulate and implement measures to prevent reoccurrence shall be implemented.
- (10) That effective controls shall be implemented in respect of the activities of all other contractors, relevant authorities and third parties.

12.12 ENGINEERING SAFETY VALIDATION PLAN

- 12.12.1 Testing shall validate that all safety related functions have been implemented in accordance with the Detailed Design and the safety requirements identified in the Design Safety Report.
- 12.12.2 A Program of all safety validations to be carried out shall be submitted and this Program shall be updated with actual dates of validation during the on-site testing and integrated system testing phase.
- 12.12.3 Validation of the correct implementation of all safety design criteria shall be demonstrated by submitting details including:
 - (a) A cross reference to the Program of safety validations;
 - (b) The purpose of each validation;
 - (c) The method of each validation;

- (d) The qualifications of staff performing the validation;
- (e) The names of witnesses to the validation;
- (f) The acceptance criteria for each validation;
- (g) The results of each validation;
- (h) Analysis of validation results to show that they confirm requirements have been met; and
- (i) The recommended procedure for the correction of deficiencies observed during the validation process and the steps required to repeat the validation.

12.13 OPERATIONAL SAFETY CASE

12.13.1 General Requirements

In order to demonstrate that the system shall be managed safely, the Contractor shall produce and maintain an Operational Safety Case, in accordance with the System Assurance requirements detailed in the Contract documents.

12.13.2 The Operational Safety Case shall typically consist of but not be limited to the following:

- (1) Executive Summary;
- (2) Introduction;
- (3) Definition of System;
- (4) Quality Management Report;
- (5) Safety Management Report;
 - (a) Introduction;
 - (b) Roles and Responsibilities;
 - (c) Safety Lifecycle;
 - (d) Safety Requirements;
 - (e) Safety Standards;
 - (f) Safety Audit and Assessment;
 - (g) Supplier Management;
 - (h) Safety Controls;
 - (i) Configuration Management; and
 - (j) Project Safety Training.
- (6) Technical Safety Report
 - (a) Introduction;
 - (b) Assurance of correct functional operation;
 - (c) Effects of faults;
 - (d) Operation with External Influences;
 - (e) Safety-related application conditions;

- (f) Safety Qualification tests; and
- (g) Other Outstanding Safety Issues.

(7) Conclusion

12.13.3 As part of the Operational Safety Case development process, the Contractor shall ensure that plans and procedures as typically listed below will be in accordance with the Operational Safety Case requirements:

- (1) System Management Plan;
- (2) System Safety Plan;
- (3) System Operating Safety Plan;
- (4) System Operating Plan;
- (5) System Assurance Plan;
- (6) Emergency Preparedness and Fault Recovery Plan;
- (7) Rules and Procedures;
- (8) Relative Indian Railways Rules and Procedures; and
- (9) Health and Safety Regulations.

12.14 PROOF OF SAFETY

The "Proof of Safety" shall demonstrate that the Works are fit for the purpose of commencing Revenue Service. The "Proof of Safety" shall make traceable reference to system documentation that shall demonstrate as a minimum the following requirements have been met:

- (1) That the Works have been manufactured, installed and tested up to an including Integrated System Testing in a manner to ensure that the Railway can be operated and maintained within the parameters of risk as approved in the "Design/Systems Safety Report" and that there are no outstanding safety issues.
- (2) That the recommended safety performance criteria and safety thresholds for the safe operation and maintenance of the Works have been met.
- (3) That the standards and specifications upon which the safe operation and maintenance of the Works are based have been met.
- (4) That the safe systems of work, rules and procedures required to operate and maintain the Works within the defined parameters of risk as approved in the "Design/Systems Safety Report" have been verified.

12.15 SYSTEM ASSURANCE DURING TRIAL RUNNING

The period of Trial Running shall include as a minimum the following activities:-

- (1) Demonstration of system performance and adherence to timetables by running a simulated revenue service at progressively increasing levels of service.
- (2) Evaluation of the effectiveness of normal operating procedures including those that deals with minor disruptions and staff unavailability.

- (3) Evaluation of the effectiveness of system fault reporting, fall back systems, operating procedures and maintenance responses in the event of a number of system failures and degraded operating scenarios by simulating such scenarios during simulated revenue service.
- (4) Evaluation of the effectiveness of operating procedures and other incident management responses in the event of a serious incident including but not limited to fire by simulating such scenarios during simulated revenue service.

12.16 SYSTEM ASSURANCE DURING REVENUE SERVICE RUNNING

The Contractor shall continue to implement system assurance activities during and after the transition to revenue service including, but not limited to, the following requirements.

- (1) Revenue Service shall not commence until the "Proof of Safety" has received the approval of the Employer.
- (2) During the Defects Correction Period, day to day monitoring of the Railway RAM performance shall be carried out and the findings shall be used to enable systematic means of data analysis and recording of the RAM performance.
- (3) In the event that a defect/failure shall arise, the Contractor shall provide full technical support in failure investigation and rectification.
- (4) The Contractor shall employ suitable mechanisms and develop a suitable organization structure in conjunction with the Employer to support ongoing RAM activities.
- (5) The Contractor shall provide support to the Operator to ensure that the documentation and processes defined in the Ongoing Management of Safety document have been fully assimilated into the Operator's Safety Management System and organization.

12.17 SYSTEM ASSURANCE DURING DEFECT NOTIFICATION PERIOD (DNP)

12.17.1 The Defect Liability /Notification shall be of minimum 24 Months from the date of Commercial operations and shall be monitored for RAMS compliance. The Failures and Performance shall be monitored on monthly basis and the result should meet the acceptable criterions. If the results of 6 months average do not meet RAM specifications than the DNP period shall be extended with full DNP obligations of the Contractors. The same may be extended with /without penalty for further period similarly.

12.17.2 During the Defect Notification Period (DNP) of the project, the following activities shall be carried out by the contractor:

- (a) Keep full records of any failures and the actions taken to restore the equipment to full service and input the record data in the FRACAS for the FRB panel to evaluate.
- (b) During this period the Contractor shall replace/ remedy from his resources the defects occurring under normal usage of Works by the Employer except for normal wear and tear under such usage.

- (c) During Defect Notification Period, Contractor shall maintain the required spares and Tools and Plants at identified place as agreed with the Employer's Engineer. The Contractor shall not utilize any spares intended to be delivered to the employer.
- (d) The Contractor shall maintain a qualified team of the required technicians and Engineers to meet DNP obligations. The Contractors shall submit a Manpower Plan showing the Contractor's organization available during Defect Liability Period.
- (e) The Contractor shall attend the periodic FRB Meeting with the Employer/Engineer to discuss the defects arising during the Defect Notification Period. The dates and agenda of the meeting shall be as per the consent by the Engineer.
- (f) If the Contractor fails to remedy any defect or damage within a reasonable time, a date may be fixed by (or on behalf of) the Employer, on or by which date the defect or damage is to be remedied. The Contractor shall be given reasonable notice of this date.

12.18 SYSTEM ASSURANCE SUBMISSIONS

Deliverable Documents

The Contractor shall implement and submit system assurance supporting documents in accordance with the approved System Assurance Plan. The Contractor shall implement and submit system assurance supporting documents in accordance with the approved System Assurance Plan.

(End of Chapter-12)

CHAPTER-13: TRAINING

13.1 TRAINING REQUIREMENTS

- (1) The Contractor shall provide comprehensive training to the Employer's Personnel in respect of design, system engineering, construction/ installation, assembly, configuration, operations, fault diagnosis and maintenance of the systems/sub-systems, provided under the Contract.
- (2) The Contractor shall arrange training at manufacturing facilities where the greatest benefit shall accrue to the trainee system engineers w.r.t. design, system engineering, assembly, installation, configuration, testing & fault diagnosis. Training at manufacturing facilities shall be for equipments as specified in respective Particular Specification. All the training courses at manufacturing facilities shall be conducted during design period and completed before the commencement of installation.
- (3) The Contractor shall also arrange training at site for the trainee operational staff and maintenance staff. The Contractor shall set up training class rooms near to site, where he shall provide competent training instructors, training manuals, all necessary aids and materials as required for all the training courses. The training courses at site shall cover working principles, installation, operation, fault diagnosis & maintenance of all major equipment and works engineered by the Contractor. All the training courses at site shall be conducted during installation period and completed before the commencement of testing and commissioning.
- (4) The training instructors, for training courses, shall be qualified, competent, with sufficient years of practical experience and possess good communication skills in the relevant fields. The training shall be in the English and Hindi languages as required. All training material for these courses shall be in English and Hindi.
- (5) Should, in the opinion of the Engineer and due to good reasons, any of the Contractor's training instructors not be considered competent or not to have a suitable attitude or aptitude for carrying out the training courses for whatever reason, the Contractor shall remove the said person and replace him as soon as possible with an acceptable substitute.
- (6) The Contractor shall provide full-time management, co-ordination and supervision of the entire training programme to ensure the continuity of classes and proper distribution of training materials and be responsible for interfacing with the instructors.
- (7) The cost of travel and stay of the trainees shall be borne by the Employer.

13.2 TRAINING PLAN

- (1) Within six months after the Commencement Date of the Works, the Contractor shall submit a Training Plan to the Engineer for review.
- (2) The Training Plan shall include, but not be limited to, the following:
 - (a) The program of the training courses at site and at manufacturing facilities;
 - (b) Overview and description of objectives of each training course;

- (c) The location where the training courses to be conducted;
- (d) Submission schedule of the training materials;
- (e) Set ups for practical exercises;
- (f) The Contractor's training organisation chart, including the role and responsibilities of individual key persons;
- (g) The qualifications and experience of the training instructors;
- (h) Duration of training for each module.
- (i) Recommended number of participants in each module.

13.3 TRAINING COURSES

- (1) Training at site shall include operation courses and maintenance courses. The class will be of maximum of 30 trainees. The Contractor in consultation with Engineer and Employer shall determine the number of classes for each type of training course, within the provisions available in respective Particular Specification, to ensure the objectives of the course can be met.
- (2) The training courses for operation staff at site shall be developed to provide all necessary knowledge and skills for operations staff of the Employer for operating the system under normal and emergency situations and recovery from minor or simple faults. In particular, the training course shall include the following as minimum:
 - (a) overview of the system/sub-system;
 - (b) brief description of the operation principles of the system/sub-systems;
 - (c) operational features and functions;
 - (d) familiarisation and use of all man-machine interfaces involved;
 - (e) reading and interpretation of system status and alarm messages or indications;
 - (f) normal operating procedures;
 - (g) operating procedures under emergency situations;
 - (h) procedures for recovery from minor or simple faults; and
 - (i) use of Operation Manuals and documentation.
- (3) Particular exercises shall be included in the training course for operation staff at site for each trainee to operate and manage the system under normal and emergency operating conditions and simple faults recovery.
- (4) The training courses for maintenance staff at site shall, as a minimum, impart the following techniques to maintenance staff of Employer of the appropriate grades:
 - (a) All planned maintenance and overhaul of the railway systems/subsystems supplied, installed or modified under the Contract;
 - (b) Fault finding and rectification techniques for the systems/subsystems including equipments supplied, installed or modified under the Contract. These shall be developed from the Contractor's previous experience with

- similar equipment and also from the fault tree analysis and other analysis carried out as part of the reliability engineering studies undertaken by the Contractor;
- (c) Normal and degraded modes of operation of the railway systems/subsystems including equipments supplied, installed or modified under the Contract;
 - (d) All rules, regulations, practices and procedures necessary for the safe and efficient operation of the railway systems/subsystems supplied, installed or modified under the Contract; and
 - (e) All contingency plans necessary to recover speedily and safely from any mishaps or emergencies that may arise with the railway systems supplied, installed or modified under the Contract.
- (5) The Contractor shall provide all training material including presentations, mock-ups, models, tables, chairs, white boards, and so on. If available, the Contractor may use training rooms of the Employer.
 - (6) The Training during operation courses and maintenance courses shall enable trainee operation and maintenance staff to achieve Competency Certificate from the competent authority.
 - (7) The training courses for system engineers at manufacturing facilities shall be developed to provide all necessary knowledge and skills to perform system engineering management including system parameter configuration, enhancement, expansion and provision of new circuits.
 - (8) The Contractor shall determine the content of the system engineering courses, however the courses shall include the following as minimum:
 - (a) overview of the system/subsystem;
 - (b) background theory;
 - (c) system features and functions;
 - (d) system configuration and operation principles;
 - (e) description of system components and equipment down to card or module level;
 - (f) test and commissioning procedures;
 - (g) use of test equipment and special tools;
 - (h) reading and interpretation of alarm indications, messages and print-outs;
 - (i) preventive maintenance procedures;
 - (j) fault diagnosis, troubleshooting and corrective maintenance procedures;
 - (k) equipment settings and parameters configuration;
 - (l) use of equipment manuals, Operation and Maintenance manuals, circuit diagrams and wiring schematics;
 - (m) methods and procedures to provide new circuits, system expansion and enhancement;

- (n) data, software backup and loading; and
 - (o) use of software such as peripheral control and configuration, utility, database structure, generation and modification.
- (9) During the Defects Notification Period, when the Contractor is responsible for fault finding and repair, he shall provide practical hands on training to Employer maintenance staff to facilitate successful handing over of the works.

13.4 TRAINING EQUIPMENT

- (1) With the prior approval of the Engineer, the Contractor may use the Works being erected, tested or commissioned for the training of Employer Personnel.
- (2) Training course notes shall be entirely compatible and where appropriate, cross-referenced to the manuals supplied by the Contractor as part of the Operation and Maintenance documentation.
- (3) The Contractor shall provide such written or printed matter, functional equipment, samples, models, cutaway equipment, slides, films and other instructional material, as may be necessary for training. Such equipment and material shall remain the property of the Employer and shall be sufficient both for the persons trained by the Contractor and for those to be subsequently trained by Employer Training Instructors.
- (4) The Contractor shall provide an instructor's guide for each training course. The guide shall include the course agenda, objectives, list of resources and facilities required, detailed lesson plans, presentation notes, discussion guides, training aids and job aids, test papers, criteria and methodology for testing and assessment, and all other things that will enable Employer's Training Instructors to carry out repeat or refresher courses in the future.
- (5) All training course notes and instructor's guides shall be submitted to the Engineer for review six (06) months prior to the commencement of the first training session of the course.
- (6) All training course notes and instructor's guides shall be in a form that allows for easy reproduction.
- (7) All training course notes and instructor's guides shall be in a standard format as decided by the Engineer.

13.5 TRAINING COURSE EVALUATION

- (1) The Contractor shall develop a system for assessment and certification of trainees to assess and verify their proficiency in the subjects being trained. The assessment and certification procedures shall be submitted to the Engineer for approval. At the end of the training period, the Contractor shall issue training certificate to the trainees who pass the assessment. Training sessions, tests, and certification processes may be witnessed by the Engineer and the Employer's Representative.
- (2) The Contractor shall, at the completion of each training course provide the Engineer a consolidated training record listing the training course title, date of training, name of all trainees, training result and other relevant information;

- (3) The Contractor shall develop questionnaires to trainees for each training course in determining the level of satisfaction with the course content. Appropriate scoring weighting shall be assigned to each question in the questionnaires such that the scores shall reflect the trainee's satisfaction to the training course. The questionnaires shall be submitted to the Engineer for review four weeks before the commencement of the training course.
- (4) The contractor shall submit the course evaluation criteria to the Engineer for approval.
- (5) The Contractor shall submit assessment reports on the performance of individual trainees to the Engineer. Training evaluation shall be required at regular intervals to monitor the progress and suitability of the training programme. Items that require further information or tasks that require additional training or practice will be discussed between Engineer and the contractor at the evaluation meetings. Such items or tasks must be appended to the training programme as soon as possible.

(End of Chapter-13)

CHAPTER-14: OPERATION & MAINTENANCE & SPARES

14.1 GENERAL

- 14.1.1 Operation and Maintenance is an important element in the execution of a project. It is essential to have a well-designed Operation & Maintenance Support Plan and Maintenance Plan before the system is made Operational. These plans shall be submitted to Engineer for review, at least six months before start of Defect Notification Period.
- 14.1.2 It shall be ensured that the resource requirement in terms of men and material as identified in the Plans is available before the system is made Operational.
- 14.1.3 The Contractor shall repair and/or replace, in each case at no cost to the Employer, any part of the Works which is found to be defective by reason of faulty design, materials or workmanship or negligence or failure on the part of the Contractor to comply with any obligation expressed or implied under the Contract, during the DNP after the date of issue of the Taking Over Certificate of the Works. The Works shall also include equipment being provided under Contract Package CP-104 which shall be upgraded/augmented/reconfigured, under this Contract if so required.
- 14.1.4 During the Defects Notification Period, as a result of an inspection made by or on behalf of the Employer at any time or times prior to its expiration, the Engineer shall have the right but not the obligation to instruct the Contractor in writing to execute all such work of repair, amendment, rectification and make good defects, imperfections or other faults in the Works and any part thereof, as the case may be.

14.2 OPERATION & MAINTENANCE PLAN

- (1) The Contractor shall prepare and submit Operation & Maintenance Plan for review by the Engineer. Operation and Maintenance Plan shall covers, but not limited to, the following items:
- (i) Submission of Technical Manuals as per respective Particular Specification;
 - (ii) Submission of Operation & Maintenance Manuals for each item/unit/equipment as per respective Particular Specification;
 - (iii) Submission of procedures for preventive & corrective maintenance, overhaul / renewal and for handling break-downs.
 - (iv) Requirement of Employer's Manpower for maintenance;
 - (v) Proposed Contractor's Manpower for Supervision of Maintenance during Defect Notification Period;
 - (vi) Operation & Maintenance training requirements for Employer's Personnel ;
 - (vii) Provision of Software Support during 'Defect Notification Period';
 - (viii) Provision of Spares, Test Equipment, Tools, etc. as per respective Particular Specifications;
 - (ix) Requirement of periodic operation of equipment and machines which would otherwise deteriorate because of non-operation for extended periods;

14.3 SUPPORT DURING DEFECT NOTIFICATION PERIOD (DNP)

14.3.1 Support and Call-out Services

- (1) The Contractor shall provide the Support & Call-out-services for maintenance of the system. The maintenance will be done by the Employer with the support of the Contractor. The Support and Call-out services shall be available 24 hours per day and 7 days per week.
- (2) The Contractor shall deploy adequate, committed and competent resources for providing desired level Support and Call-out-services. As a minimum, the expert of each sub-system shall be provided by the contractor at every IMD/IMSD location. All the resources shall be trained before deployment.
- (3) The resource deployment shall be as per Operation and Maintenance Support Plan approved by the Engineer. The Contractor shall provide a list of staff together with the contact landline/mobile telephone numbers who can be contacted for Support and Call-out-services. Any change in the staff or his call-out number shall be notified to the Engineer at least two weeks before such change becomes effective.
- (4) The Contractor's response Time for Support & Call-Out-Services shall not exceed one hour. The Response Time is defined as the time that elapses between the reporting of a fault and the Contractor's Call out personnel arriving at site where the faulty equipment is located.
- (5) In case of any abnormal System behavior like intermittent faults, interference, frequent repeated faults, etc. occur or the performance is found to deviate from the specified tolerances, the Contractor shall conduct investigations and report the findings to the Engineer along with the recommendations and proceed after the recommendation has been reviewed without objection by the Engineer. The Contractor shall take every precaution to protect existing equipment from damage and make good any damage caused.

14.3.2 Workshop Repair

- (1) The Contractor shall provide Workshop repair services for all defective and faulty items of the System and shall collect and repair defective parts that are removed from the System during corrective and predictive maintenance.
- (2) The Contractor shall perform all necessary adjustments or alignments as required to the repaired parts. The repair of defective parts can only be considered as completed and returned to stock or back to the System if the parts are tested and verified fit for use in the System.
- (3) The Contractor shall use only components of equal or better specification than the original components in his repair activities. The performance of the defective parts after repair shall not be degraded or deteriorated due to repairs.
- (4) The maximum turnaround time for workshop repair shall be less than 28 calendar days. The turnaround time count shall start from the time the defective parts are removed from the System and shall continue till the parts are repaired and returned to stock or to the System. Any extension of workshop repair time shall be agreed with the Employer.

14.4 EXTENSION OF DEFECT NOTIFICATION PERIOD

In case of failure of the Contractor to achieve the RAMS Targets specified in the Employer Requirement:

- (1) The Defects Notification Period shall stand extended for a further period corresponding to period of failure;
- (2) The Performance Guarantee shall stand extended for a period corresponding to the extension of the Defects Notification Period; and
- (3) All work required to be carried out by the Contractor for the rectification of defects, shall be carried out at the Contractor's own expense.

14.5 OPERATION AND MAINTENANCE (O&M) MANUALS

14.5.1 In addition to the various existing Codes and Manuals applicable to Indian Railways for operation and maintenance of systems such as Traction Power Supply, OHE system, SCADA, Signaling and Telecommunication etc., the Contractor shall produce Manuals covering the additional provisions, over and above the various existing Codes and Manuals of Indian Railways in respect of the Operation and Maintenance requirements of various assets created under the Contract.

14.5.2 With reference to the requirements as above:

- (1) The Contractor shall produce manuals for all equipment and manufactured items and sub-systems, supplied and created under the Contract, for their efficient operations and maintenance. These shall include, but not be limited to, the following manuals:
 - (a) Maintenance of Traction Power Supply Equipment;
 - (b) Maintenance of Traction OHE Equipment's;
 - (c) Maintenance of Traction SCADA System;
 - (d) Maintenance of Buildings & Structures including E&M;
 - (e) Maintenance of Signalling Equipment:
 - (i) Electronic Interlocking System
 - (ii) Point Machines
 - (iii) Track Vacancy Detection System
 - (iv) Power Supply System for Signalling
 - (v) Signalling cables
 - (vi) Earthing, Lightning and Surge Protection System
 - (vii) Service and Diagnostic System
 - (viii) Data Logger System for Event Logging and Predictive Maintenance
 - (f) Maintenance of Train Management System:
 - (i) Interface equipment for transfer of data
 - (ii) Video Wall Display system in OCC

- (iii) Automatic Train Charting
- (g) Maintenance of Telecommunication Equipment:
 - (i) Optic Fibre Cable Communication System
 - (ii) Data Networking System
 - (iii) Telephone System
 - (iv) Mobile Train Radio Communication System
 - (v) Master Clock System
 - (vi) VHF Communication System
 - (vii) Earthing, Lightning and Surge Protection System
 - (viii) Emergency Communication System
 - (ix) Control Office Equipment for Train Dispatch
 - (x) Power Supply System for Telecommunication
- (h) System/Sub-System Manuals- A comprehensive description of all system principles at block diagram level.
- (i) Operating/User Manuals - broken into as many sub-sections as necessary and providing sufficient information to enable non-technical staff to exploit fully the facilities of each system. The Operating Manual of EI shall contain detailed description of all the operations of the SM's Control terminal with coloured illustrations.
- (j) Workshop Manuals - Installation and circuit descriptions, full schematics, circuits, wiring diagrams, mechanical construction/installation drawings and itemized parts list to enable all maintenance rectification and setting-up to be carried out.
- (k) Software System Manual - for each software package and each piece of equipment which incorporates Programmable Device(s), licensed copies of CD/DVD of application and peripheral software along with write up on software features, instructions for configuration, working of software and procedures for taking out report and data in the form of instruction manual/guide.
- (l) As-Built Documents- all wiring diagrams and circuits, equipment layout, terminal and cable listing and including such external equipment as may be necessary for completeness.
- (2) Maintenance Manuals shall contain the following but not limited to;
 - (a) Technical description of each system and sub-system of equipment installed to ensure that the Employer's technical staffs fully understand the scope and facilities provided.
 - (b) Diagrammatic drawings of each system indicating principal components and items of equipment
 - (c) Name, addresses, telephone, e-mail and fax numbers of the manufacturer of every item of equipment

- (d) Manufacturer's service manual for each major item of equipment, assembled specifically for the project including detailed drawings, illustrations, circuit details, operating and maintenance instructions, modes of operation, control provisions, sequences and interlocks and preventative maintenance Program
- (e) Procedures for fault location and isolation
- (f) Maintenance procedures and their periodicity. The contractor must give list of Items to be checked, adjustments to be made, safety checks to be performed and frequency of maintenance for each item of the sub-system/equipment. These maintenance Schedules should be compiled in the form of a register and shall be kept at stations for recording of the maintenance. It should lead to computerization of the maintenance activities.
- (g) Tools and Plant needed for maintenance of different Equipment provided in the Works.
- (h) Configuration Manual for all equipment, wherever required.
 - (i) All test results conducted on the relevant equipment whether at the manufacturer's place or at site; and
 - (ii) Manufacturers' lists of recommended spare parts for items subject to wear and deterioration, giving expected running period and indicating specifically those items, which may involve extended deliveries.
- (i) All test results conducted on the relevant equipment whether at the manufacturer's place or at site
- (j) Manufacturers' lists of recommended spare parts for items subject to wear and deterioration, giving expected running period and indicating specifically those items, which may involve extended deliveries.
- (3) The Operating/User Manuals and Maintenance Manuals of Systems/Sub Systems suitable for use at technician level, shall be prepared in both English and Hindi languages unless otherwise instructed by the Engineer.
- (4) The Contractor shall provide 6 copies of all Manuals along with electronic version for the use of the Employer's Staff/Engineer.
- (5) The Contractor shall maintain all Manuals in an updated condition throughout the Contract Period, wherever applicable.
- (6) O&M Manuals and drawings as submitted by the Contractor shall be updated by him during the Defects Notification Period, if required and shall be re-submitted to the Engineer for review without any extra cost to the Employer.

14.6 MAINTENANCE PLAN

- 14.6.1 While Operation & Maintenance Support Plan take care of day to day operation and maintenance of the systems/sub-systems, the Maintenance Plan is designed to put the maintenance practices on sound footing for proper upkeep of the systems. The Maintenance Plan shall be prepared by the Contractor and submitted to the Engineer for review at least 12 months before start of Defect Notification Period.

- 14.6.2 The Maintenance Plan shall describe, but not limited to, the following:
- (1) Maintenance philosophy and approach,
 - (2) All necessary tasks for first line, second line, third line and corrective maintenance,
 - (3) Frequency of each maintenance task,
 - (4) Employer's and Contractor's proposed maintenance regime for maintenance,
 - (5) Maintenance Schedules (Daily, Weekly, Monthly) detailing maintenance task for each maintenance team member;

14.6.3 The Maintenance Plan shall be aligned with the Employer's maintenance policy.

14.7 MAINTENANCE SCHEDULES

14.7.1 The Contractor shall prepare the Maintenance schedule for each item/equipment required to be maintained. The schedule should give the details such as the frequency of maintenance, the items to be maintained, the tolerances permitted and the safety checks to be performed. The Contractor shall submit the Maintenance Schedule to the Engineer for review.

14.7.2 In addition to the above, the Contractor shall include in the Maintenance Schedule the following information:

- (1) The equipment, sub-systems covered in the task,
- (2) Step by step procedure to carry out the task,
- (3) Tools and test equipment required for each task,
- (4) Diagrams and flowcharts by illustration, if applicable,
- (5) Adjustment procedures for all field adjustable units,
- (6) Recovery procedures, if applicable,
- (7) Precautions to be followed by maintenance personnel and
- (8) Estimated duration and manpower required;

14.8 MONTHLY MAINTENANCE MEETING

The Contractor shall attend the Monthly Maintenance Meeting with the Engineer to discuss the maintenance matters during the Defect Notification Period. The dates and agenda of the meeting shall be agreed with the Engineer.

14.9 SOFTWARE SUPPORT

14.9.1 The Contractor shall provide full support to the Employer and the Engineer for all computer programs, which are supplied by the contractor under the scope of this Contract.

14.9.2 The Contractor shall provide to the Employer and the Engineer one (1) copy each of the software packages with the same software products as those that the Contractor intends to use for the project. The Contractor shall utilize a shared electronic document management system with the Engineer and the Employer which shall be web / internet based.

- 14.9.3 The Contractor shall provide all tools, equipment, manuals and training necessary for the Employer/Engineer to maintain, re-configure and to make proper use of all the software provided under the Contract. This shall include supply of any specified development tools required for maintenance of the software, including but limited to editors, compilers and linkers.
- 14.9.4 If any software is developed under the Contract or used by the Contractor for the purposes of storing or utilizing records over which the Contractor or a third party holds title or other rights, the Contractor shall permit or obtain for the Employer and Engineer the right to use the Software free of any additional charge, together with any modifications, improvements and developments thereof, for the purpose of the reinstatement, extension, repair, modification or operation of the Works, or any part thereof, or to avoid any Dispute.
- 14.9.5 The Contractor's permission referred to above shall be given, inter-alia, to enable the Employer to disclose (under conditions of confidentiality satisfactory to the Contractor) program and documentation for a third party to undertake the performance of services for the Employer in respect of such program and documentation.
- 14.9.6 The Contractor shall submit a Software support plan at least ninety (90) days before commencement of software installation. This plan shall require the Contractor to provide all changes, error fixes, updates, modifications, amendments and new versions with the updated instructions, and Operation and Maintenance Manuals of the program as required.
- 14.9.7 The Contractor shall submit all new versions to the Engineer for review at least two (02) weeks prior to their installation. The Engineer will not be obliged to use any new version and this shall not relieve the Contractor of any of its obligations.
- 14.9.8 The Contractor shall:
- (1) ensure that all new versions are fully tested and validated on the simulation and development system and reviewed without objection by the Engineer prior to installation;
 - (2) ensure that all new versions are fully tested and commissioned once installed on the site; and
 - (3) Deliver with the new version, updated Operation and Maintenance Manuals.
 - (4) All new version of software shall be accompanied by a release note containing the following details:
 - (a) Version number
 - (b) Modifications made to the previous version;
 - (c) Check sum
- 14.9.9 The new Versions of any program shall not result in any non-conformance with the Specification or degrade the performance or have adverse impact on the System. Any effect upon the performance or operation of the computer-controlled system that may be caused by a new version shall be brought to the Engineer attention including updating the files to suit new version.
- 14.9.10 The Employer reserves the right to use other Software in connection with the Works.

14.10 SERVICE LIFE SUPPORT

- 14.10.1 The Contractor should ensure availability of full support to the Employer for operation, maintenance, customization and up gradation of system/sub-system supplied and installed by him as part of the Contract.
- 14.10.2 The Contractor shall undertake to provide, if required during the life of the equipment provided under Contract, technical assistance in the form of additional drawings, maintenance practices and technical advice (including training).
- 14.10.3 For all imported systems/subsystems, the Contractor must ensure:
- (a) Establishment of Servicing facility in India.
 - (b) Establishment of Customization facility to add/modify/re-engineer hardware/software of the subsystem as required by the Employer during the lifetime of the equipment for adding facilities including up gradation etc.
 - (c) Establishment in India to undertake Annual Maintenance Contract (AMC) during the service life of the equipment.
 - (d) Supply of Spares for entire service life of the equipment.
 - (e) Supply additional equipment required for replacement or expansion of the network in future.
 - (f) Training of Employer's Personnel to reach qualified levels for operation and maintenance.
- 14.10.4 The Local Service Centre shall have test and repair facility with simulation test set-up, fault diagnostic system, test jigs, software for testing of cards/modules along with required test instruments and tools.
- 14.10.5 The Contractor/OEM of the system/subsystem shall be required to undertake comprehensive Annual Repair Contract (ARC) at the end of Defect Notification Period. The comprehensive ARC may include supply of cards/modules for repairs/replacement of the sub system/system.
- 14.10.6 The contractor shall ensure that the OEM should either provide support as above on his own or sign an MOU with suitable Indian companies or company having proven track record and are working in related areas for all imported systems/subsystems. The copy of the MOU shall be submitted to the Employer as a proof of continuous support.
- 14.10.7 The sub systems/systems of OEMs who are for complete Transfer of Technology (TOT) including system assembly, manufacturing, installation, maintenance and software modification/customization, training etc. shall be preferred for use by the Employer. In such case, the contractor shall submit the detailed plan for progressive manufacture of imported items by OEM in India.
- 14.10.8 Cost of any supply / service provided by the Contractor / OEM beyond DNP /extended guarantee period (wherever applicable), shall be borne by the Employer.

(End of Chapter-14)

CHAPTER-15: APPENDICES

This Chapter includes a number of Appendices as listed below:

APPENDIX 1 –MONTHLY PROGRESS REPORT

APPENDIX 2 - DRAWINGS AND CAD STANDARDS

APPENDIX 3 - DESIGN CERTIFICATES

APPENDIX 4 - TEMPORARY WORKS

APPENDIX 5 - REQUIREMENTS FOR CONSTRUCTION

APPENDIX 6 - ENVIRONMENT PROTECTION REQUIREMENTS

APPENDIX 7 - PMIS REQUIREMENTS AND PROCEDURES

APPENDIX-1: MONTHLY PROGRESS REPORT

1. GENERAL

- a. The Contractor shall prepare and submit Monthly Progress Reports in at least 5 Copies (hard) in English as well as in Electronic Medium or CD covering all aspects of the execution of the Works.
- b. Monthly Progress Reports shall be delivered to the Engineer by the 7th day of the month reporting the progress of the work performed from 1st day of the previous month till the Last day of previous month to which the Monthly Progress Report relates.
- c. The Monthly Progress Report shall contain evidences that documents and supports indicating the progress of the Works, as stated in the interim Certificate of Payment, to the satisfaction of the Engineer.
- d. The reports, documents and data provided shall be an accurate representation of the current status of the Works and of the work to be accomplished and shall provide the Engineer with a sound basis for identifying problems and deviations from planned work and for making decisions.
- e. The results of quality audits shall be summarized in the Contractor's monthly reports.
- f. It shall be submitted in English in Six hard copies and one copy in electronic storage device.
- g. It shall be submitted in a format agreed to by the Engineer and shall contain sections/sub-sections for, but not be limited to the topics mentioned below.
- h. Benchmarking, setting out, photography, videography, report submission, permanent markers like cable markers, signages, boards etc. As built documents, inspection books, registers for record & maintenance of system works.
- i. Monthly Progress Report format, as approved by the Engineer shall comprise the following information:
 - i. Executive Summary
 - ii. Achievements of the month
 - iii. Top 10 significant issues
 - iv. Health, Safety and Environment Compliance
 - v. Quality Assurance Issues
 - vi. Design / Engineering Status
 - vii. Procurement Status Report (i.e. statement with PO date, Manufacturer name, LC date, FAT test date, Shipping / Dispatch date, Delivery date)
 - viii. The Status (Manufacturing / Supply / Installation / Testing) of stages of Works i.e. Physical Progress of activities
 - ix. Work Program Progress status
 - x. Any delay/ shortcomings from the Targets, constraints and Measures Proposed

- xi. Financial Progress Status
- xii. Procurement status report
- xiii. Progress marked on 3 month's rolling Program
- xiv. Assistance Required if any

2. SAFETY

A review of all safety aspects during the month including reports on all accidents and actions proposed to prevent further occurrence including details of safety training and drive conducted during the period and proposed in coming months. This shall be the first item of Monthly Progress Report.

3. FINANCIAL STATUS

- (1) A narrative review of all significant financial matters and actions proposed or taken in respect of any outstanding matters.
- (2) A spread sheet indicating the status of all payments due and made including recoveries, if any.
- (3) A report of the status of any outstanding claims even if these is NIL.
- (4) The report shall in particular provide interim updated accounts of continuing claims.

4. PHYSICAL PROGRESS

- (1) It shall describe the status of work performed in descriptive form, significant accomplishments, including critical items and problem areas including current and anticipated delaying factors and their impact, corrective actions taken or planned and other pertinent activities and shall, in particular, address interface issues with all agencies involved, problems and resolutions during the period or anticipated.
- (2) It shall include a simplified representation of progress measured in percentage terms compared with percentage planned as derived from the Works Program.

5. PROGRAM UPDATE FOR ENTIRE PROJECT

- (1) Program updating shall include:
 - a. The monthly program update which shall be prepared by recording actual activity completion dates and percentage of activities completed up to the last day of the month and expected activity completion based on current progress.
 - b. The Program update shall be accompanied by an activity report and a narrative statement.
 - c. The narrative statement shall explain the basis of the Contractor's submittal:
 - i. Early Work and baseline submittals – explains determination of activity duration and describes the Contractor's approach for

- meeting required Key Dates as specified in Chapter- 4:" Project Program Requirements" of this GS
- ii. Updated detail program submittals – state in the narrative the Works actually completed and reflected along critical path in terms of days ahead or behind allowable dates, specific requirements of narrative are:
 - If the updated detailed work program indicates an actual or potential delay to Contract Completion date or Milestones, identify causes of delays and provide explanation of work affected and proposed corrective action to meet Milestones or mitigate potential delays.
 - Identification of any deviation from previous month's critical path.
 - Identify by activity number and description, activities in progress and activities scheduled to be completed.
 - Discuss variation work order items, Value Engineering items, if any.
 - d. Program Status which shall:
 - i. Show Works Program status up to and including the current report period, display cumulative progress to date and a forecast of remaining work.
 - ii. Be presented as a bar-chart in size A3 or A4.
 - e. The activity variance analysis which shall analyze activities planned to start prior to or during the report period but not started at the end of the report period as well as activities started and/or completed in advance of the Works Program.

6. THREE-MONTH ROLLING PROGRAM

The three month rolling program shall be issued on a monthly basis.

7. PLANNING AND CO-ORDINATION

- (1) A summary of all planning/co-ordination activities during the month and details of outstanding actions.
- (2) A schedule of all submissions and consents/approvals obtained/outstanding.

8. PROCUREMENT REPORT

- (1) A summary of all significant procurement activities during the month, including action taken to overcome problems.
- (2) A report listing major items of plant and material which will be incorporated into the Works.
- (3) The items shall be segregated by type and the report should show as a minimum the following activities:

- a. Purchase order date - scheduled/actual;
- b. Manufacturer/supplier and origin;
- c. Letter of credit issued date;
- d. Manufacturer/supplier ship date - scheduled/actual;
- e. Method of shipment;
- f. Arrival date in India- scheduled/actual.

9. PRODUCTION AND TESTING

- (1) A review of all production and manufacturing activities during the month.
- (2) Summaries of all production and manufacturing outputs during the month together with forecasts for the next month.
- (3) Review of all testing activities (both at Site and at the manufacture's premises) during the month

10. DEPLOYMENT OF MANPOWER MATERIAL AND EQUIPMENT AT SITE

- (1) Detail showing the extent of deployment of manpower, equipment and stock of important construction material utilized at the Site.
- (2) A list of major construction equipment used on the Project during the reporting period and any construction equipment idle during the reporting period.
- (3) A list of all major or critical material and equipment, indicating current availability and anticipated job Site delivery dates.
- (4) The total number of personnel by craft actually engaged in the work during the reporting period, defined separately as to office, supervisory, and field personnel.
- (5) A manpower and equipment forecast for the upcoming twenty eight (28) days, stating the total number of personnel by craft, defined separately as to office, supervisory and field personnel.
- (6) Changes or additions to Contractor's supervisory personnel that occurred from the preceding Monthly Progress Report. The Monthly Progress Report shall accompany the Application for Payment and monthly schedule update

11. Progress Photographs and Videography

- (1) The Contractor shall provide monthly progress photographs to demonstrate the progress of the works.
- (2) Two sets of photographs shall be provided on electronic storage device with two sets of Colour prints of 175 mm x 125 mm size.
- (3) All Photographs shall be labeled with the location and the date.
- (4) The Contractor shall ensure that no photography is permitted on the Site without the consent of the Engineer.
- (5) Construction/Installation activities working of machinery, weather effects or any

occasion advised by the Engineer shall be video graphed. The recording shall be done or converted to .avi format and presented in electronic storage device with appropriate voice recording describing the event.

- (6) The Contractor shall provide to the Employer for every calendar quarter, a video recording, which will be compiled into a 3 (three) – hour compact disc or digital video disc, as the case may be, covering the status in that quarter. The first such video recording shall be provided to the Employer within 7 (seven) days of the LOA of the Contract and thereafter, no later than 15 (fifteen) days after the close of each quarter.

(End of Appendix-1)

APPENDIX 2 –DRAWINGS AND CAD STANDARDS

1. GENERAL

- (1) The purpose of this section is to define the Drawing and CAD standard and their standards for submissions, the acceptable file formats and content formats to help development of coordinated documents and drawings in common formats.
- (2) The titles & numbering, scale of drawings shall be as per relevant Indian Railway Manual/ IS Standards as well as above CAD standards as mutually agreed by the Contractor and the Engineer.
- (3) Drawings shall use as far as possible, symbols used internationally.
- (4) All legends, notes on drawings and schedules of material shall be in English and shall be prepared in the metric system
- (5) The Contractor shall submit six hard copies and a soft copy of the Detailed Design and drawings including calculations for review by the Engineer. After receipt of "Notice of No Objection" from the Engineer, the Contractor shall submit six (6) copies of the Design and / or Drawings for the use of the Engineer.

2. SOFTWARE

- (1) The following software compatible for use with Intel-Windows based computers shall be used unless otherwise stated, for the various electronic submissions required:

<u>Document Type</u>	<u>Electronic Document Format</u>
AutoCAD Graphics	CorelDraw, Ver. 12.0/ AutoCAD 2011 or latest versions
Photographic	Adobe Photoshop CS2 or latest version
Desktop Publishing	Page Maker 7.0 or latest version
CAD Drawings	AutoCAD 2011 or latest version.

- (2) For electronic file submission one copy shall be submitted unless otherwise stated on CD-ROM media. The media shall be CD-R and the recording method shall not allow any further changes to the recordable disk.
- (3) Internet File Formats/Standards:
 - a. The following guidelines shall be followed when the Contractor uses an internet browser as the communication media to share information with the Engineer /Employer.
 - b. All the data formats or standards must be supported by Microsoft Internet Explorer version 7 or above running on Windows XP or above.
 - c. The following lists the file types and the corresponding data formats to be used on internet. The Contractor shall comply with them unless prior consent is obtained from the Engineer for a different data format:

<u>File Type</u>	<u>Data Format</u>
Photo Image	Joint Photographic Experts Group (JPEG)

Image other than Photo	GIF or JPEG
Computer Aid Design files (CAD)	Computer Graphics Metafile (CGM) and DWG
Video	Window video (.avi)
Sound	Wave file (.wav)

- (4) The following states the standards to be used on the internet when connecting to database(s). The Contractor shall comply with them unless prior consent is obtained from the Engineer for a different standard:

<u>Function to be implemented</u>	<u>Standard to be complied with</u>
Database connectivity	Open Data Base Connectivity (ODBC)
Publishing hypertext language on the World Wide Web	Hyper Text Markup Language (HTML)

3. TITLE BLOCKS AND DRAWING NUMBERING

- a. The Contractor shall adopt a title block similar to that used in the drawings for all the Contractor's documents prepared under the Contract.
- b. Each document shall be uniquely referenced by a document number and shall define both the current status and revision of the drawing.
- c. The drawing numbers will be in the digits/format as defined Below:
 - i. X/X/XX/XXX-XXX/XXXX-X i.e P/4/OL/MGS-ALD/0021-A
- d. The current status of each document shall be clearly defined by the use of a single letter code as follows:
 - i. A single letter character denoting the status of the drawings e.g.
 - T Tender Design
 - P Preliminary Design
 - W Working Drawing
 - M Manufacturing Drawing
 - S Site Drawing
 - D Shop Drawing
 - A As Built Document
 - ii. A single digit code denoting the contract number (for the whole line)
 - 1 Design
 - 2 Civil / Track Works from _____ to _____
 - 3 Systems Works
 - 4 Traction System
 - 5 E&M

- iii A two (2) letter code denoting the type of System Works or system elements e.g.
- CG General Works
 - ST Stations
 - TU Tunnels (if any)
 - AL Alignment
 - RW Right - Of - Way
 - CE Civil Engineering (earth work, culverts, pedestrians, foot bridge, agricultural underpass, survey, track drainage, etc.)
 - RB Railway Bridges
 - RO Road Over Bridges
 - RU Road Under Bridges
 - EC Environmental Control System
 - UT Utilities (Power, Gas, Telecoms, Electric, Water supply, Sewer lines)
 - SE Structural Engineering (structural steel, reinforced concrete etc.)
 - GE Geotechnical Engineering (Instrumentation, ground treatment, de-watering, etc.)
 - AR Architecture
 - LS Landscape
 - EE Electrical Engineering (low voltage)
 - ME Mechanical Engineering (ventilation, fire fighting, plumbing)
 - PS Power Supply (high voltage, traction power)
 - SG Signalling (train control)
 - CM Telecommunications, SCADA System
 - TK Track-work
 - TM Traffic Management (Roads, Pavements)
 - WS Water Supply
 - SW Switching Stations
 - GS Grid Sub-station
 - TS Traction Sub-station
 - TR TRACTION
 - TL Transmission Line
 - SC SCADA system
 - OL Overhead Line Equipment
- iv Section

- A Unique & digit Code for identifying Station from – to
Like MGS-ALD to define the section between Mughalsarai to Allahabad
- v Location Code
- Unique Location code shall be essential to identify the location of Installation, , station code/ TSS code/ OCC code
- vi A unique Four (4) digit number (from 0001 to 9999), identifying each drawing.
- vii A single letter (A to Z except I and O) denoting the sequence of revision to the drawing. The initial drawing issue will carry a revision letter "A".

Example: Drawing Title Block:

Status	Drawing No:	Revision:
P	4 / SC / MGS-ALD/ ALD/0235	B

(Note: The comparable computer reference is "4SCMGS-ALD-0235B")

Denotes:

(P) Traction System/SCADA/ Section between MGS-ALD/ Location ALD/Drawing' identifying Number 0235, Revision B.

4. TYPES OF DRAWINGS

Types of Drawing such as 'Working drawings', Layout Drawings, Equipment Drawings, Shop Drawings, Reference Drawings and Manufacturing Drawings and As Built Drawings.

5. COMPUTER AIDED DESIGN AND DRAWING (CAD) STANDARDS

5.1 The main objectives of the CAD standards are as follows:

- To ensure that the CAD data files produced for project are coordinated and referenced in a consistent manner.
- To provide the information and procedures necessary for a CAD user from one discipline or external organization to access (and use as background reference), information from a CAD data file prepared by another discipline or external organization.
- To standardize the information contained within CAD data files which may be common to more than one discipline such as drawing borders, title boxes, grid lines etc.
- To establish procedures necessary for the management of CAD data files.
- To ensure all contractors use 'Model space' and 'Paper space' in the production of their CAD files.
- To facilitate co-ordination between contractors, all drawings issued by contractors for co-ordination or record purposes shall be produced using CAD methods.

- g. The intent of the issue of digital information is to aid the interface design by others.
- 5.2 The definitive version of all Drawings shall always be the paper or polyester film copies which have been issued by the Contractor or organization originating the drawing and also held in the Project's electronic document control system.
- 5.3 Drawings and drawing packages issued for co-ordination, record purposes or for acceptance shall be accompanied by a complete set of the corresponding CAD data files.
- 5.4 Any contractor or organization making use of the CAD data from others shall be responsible for satisfying him that such data is producing an accurate representation of the information on the corresponding paper drawing which is satisfactory for the purpose for which he is using it, provided the general principles of this section have been achieved by the originator of the CAD data, contractors making use of the CAD data from others shall not be entitled to require alterations in the manner in which such CAD data is being presented to them.
- 5.5 In particular, automatic determination of physical dimensions from the data file shall always be verified against the figured dimensions on the paper or polyester drawings.
- 5.6 Figured dimensions shall always be taken as correct where discrepancies occur.

6. TERMINOLOGY AND ASSOCIATED STANDARDS

Any terminology used within this section that is ambiguous to the user shall be clarified with the Engineer. Indian national and Indian Railways standards are to be used in principle as a guide for drawing practice, convention, CAD data structure and translation.

7. PAPER DRAWINGS

For the Project "Paper" drawings are considered to be the main vehicle for the receipt and transmittal of design and production information, typically plans, elevations and sections.

8. CAD QUALITY CONTROL

- a. Random CAD Quality control audits will be carried out by Engineer on all CAD media received and transmitted.
- b. These checks DO NOT verify the technical content of the CAD data received or transmitted (as this is the responsibility of the originating organization); however compliance with project CAD and Drawing Standards shall be checked.
- c. In addition, all contractors who transmit and receive CAD data from the Project shall have CAD quality control procedures in place.
- d. A typical quality control procedure shall contain CAD data quality checking routines coupled with standards for CAD data transmittal and archiving.

9. CAD DATA TRANSFER MEDIA AND FORMAT

When CAD data is received and transmitted between the Engineer and the Contractor, the media shall be as follows:

- a. All CD-R/RW and DVD+/-R must be labeled on the data shield with:
 - i. Name of Company
 - ii. Project Title
 - iii. Drawing Filenames
 - iv. Disk No. / Total No. of disks
- b. All media shall be submitted with a completed form (CAD Disk)
- c. The CAD transmittal format from contractors shall be in AutoCAD (version 2011) or latest.

10. REVISIONS

All 'Revisions', 'In abeyance' and 'Deletions' shall be located on a common layer which can be turned on or off for plotting purposes.

11. BLOCK LIBRARIES, BLOCKS AND NAMES

- a. All Symbols produced as CAD Cells shall conform to Indian or International Standards.
- b. All blocks created shall be primitive (i.e. NOT complex) and shall be placed absolute (i.e. NOT relative).
- c. The Contractor's specific block libraries shall be transmitted to Engineer together with an associated block library list containing the filename (max. 6 characters) and block description.
- d. The Contractor shall ensure that the library is regularly updated and circulated to all other users, together with the associated library listing.
- e. All blocks of a common type, symbols or details should initially be created within a CAD "Model Space File" specifically utilized for that purpose. These files will be made available on request by Engineer.
- f. All blocks created will typically be 2D unless 3D is specifically requested. They shall have an origin at a logical point located within the extents of each block's masked area or volume.

12. CAD DIMENSIONING

- a. Automatic CAD Dimensioning will be used at all times.
- b. Any dimensional change must involve the necessary revision to the model space file.
- c. If the CAD Quality Control Checks find that the revisions have not been correctly carried out, the rejection of the entire CAD submission will result.

13. CAD LAYERING

- a. All CAD elements shall be placed on the layers allocated for each different discipline.

- b. The Contractor's layer naming convention shall be submitted for the Engineer's approval.

14. GLOBAL ORIGIN, LOCATION AND ORIENTATION ON THE ALIGNMENT DRAWINGS

- a. Location or plan information in "Model Space" files shall coincide with the correct location and orientation on the project grid for each specific contract.
- b. Location plans shall have at least three setting out points shown on each CAD "Model Space" file. Each setting out point shall be indicated by a simple cross-hair together with related East and North co-ordinates.
- c. The Contractor shall establish the three setting out co-ordinates for their respective works which will then be used by the Contractor and the sub-contractor(s), if any.

15. LINE THICKNESS AND COLOUR

To assist plotting by other users, the following colour codes will be assigned to the following line thickness / pen sizes:

Colour	Code No.	Line Thickness
Red	10	0.18
White	7	0.25
Yellow	2	0.35
Brown	34	0.5
Blue	130	0.7
Orange	30	1.0
Green	3	1.4
Grey	253	2.0

16. CAD UTILIZATION OF 2D AND 3D FILES

Although the project standard is 2D CAD files, certain disciplines and contractors may use 3D CAD files for specific applications or where the isolated use of 3D aids the design and visualization process (i.e. architecture, survey and utilities).

(End of Appendix-2)

APPENDIX-3: DESIGN CERTIFICATE

The Contractor shall submit the Design Certificate with all Design Documents and Drawing. All the Drawings shall be printed with Design certificate signed and issued by Project Manager of Contractor.

DESIGN CERTIFICATE

This Design Certificate refers to Submission No..... which comprises:

[*Design Package No. / the Detailed Design and Drawing Submission No. / Technical Submission No.] in respect of:

[description of the Works to which the submission refers]

The contents of this submission are scheduled in Section A below.

The documents scheduled in Section B below, for which a Notice of No Objection has been issued, are of relevance to this submission.

DESIGNER'S STATEMENT

We hereby certify that:

- a) The design of the Works, as illustrated and described in the documents scheduled in Section A below, complies with the specifications requirements and..... [see note 1 below];
- b) The outline designs, design briefs and performance specifications of those elements of the Works as illustrated and described in the documents scheduled in Section A below comply with the specifications requirements and..... [see note 1 below];
- c) The design of the Works, as illustrated and described in the documents scheduled in Section A below, complies with the Employer's Requirements specifications requirements and..... *[see note 1 below]* except in the following respects:
 - (i) (to be completed by Contractor/Designer)
 - (ii) (etc.)
- d) An in-house check has been undertaken and completed to confirm the completeness, adequacy and validity of the design of the Works as illustrated and described in the documents scheduled in Section A below;
- e) All necessary and required approvals relating to the design of the Works, as illustrated and described in the documents scheduled in Section A below, have been obtained and copies of such approvals are annexed in Section C below;
AND (in the case of a submission covering a part of the Works only):
- f) All effects of the design comprising the submission on the design of adjacent or other parts of the Works have been fully taken into account in the design of those parts.

Signed by 'Authorized Representative'

(for Designer)

Name

Position/ Designation

Date

CONTRACTOR'S CERTIFICATION

This is to certify that all design has been performed utilizing the skill and care to be expected of a professionally qualified, competent designer, experienced in work of similar nature and scope. This further certifies that all works relating to the preparation, review, checking and certification of design has been verified by us.

Signed by 'Authorized Representative' (for Contractor)

Name

Position/Designation

Date

Note 1

The Contractor shall insert one of the following, as applicable:

- (i) The Contractor's Technical Proposals
- (ii) The Contractor's Technical Proposals and Design Packages Nos. for which a Notice of No Objection has been issued.
- (iii) Design Packages Nos. for which a Notice of No Objection has been issued if such Design Packages develop and amplify the Contractor's Technical Proposals.
- (iv) The Detailed Design

Section A

Submission no. comprises the following :

Drawings : *(Title, drawing number and revision)*

Documents: *(Title, reference number and revision)*

Others:

Section B

Documents for which a Notice of No Objection has been issued and which are of relevance to this Submission No.

Document:

Submitted with

[*Design Package No. /

Detailed Design Submission No. /

Good for Construction Drawing Submission No. /

Technical Submission No. /

Date of Issue of Notice of No Objection

}
|
|
|
|
|
}

*The Contractor is required to provide this
information in respect of each document in
Section B*

(* Delete as appropriate)

Section C

[Contractor to attach copies of necessary and required approvals]

(End of Appendix-3)

APPENDIX-4: TEMPORARY WORKS

1. SCOPE

- (1) All necessary Temporary Works required for the realization of the works such as Temporary Facilities and Temporary Utility Services including labour camps shall be provided & maintained by the Contractor for his own use, for his sub-contractors, the Engineer & the Employer unless otherwise authorized by the Engineer. The standard conditions applying to Temporary Power Supply to any Works Area by the Contractor for its Site facilities are detailed but not limited to, as under. To facilitate Permanent works the contractor would be required to establish temporary Installation may include but not limited to:
 - a. Site office, Ware house , Material stock area, fencing of site,
 - b. Lighting, water and power supply distribution, cabling and earthing at site
 - c. Construction Equipment supply , mobilization and installations
 - d. Labour camp
 - e. chartered/ unchartered utility Diversions
- (2) The Contractor shall take adequate precautions in the provision & the maintenance of the Temporary Power Supply to Temporary Works and to Works areas. To establish temporary Utility power, the work should be carried by the skilled electrician under the supervision of qualified engineer and the site shall be monitored by the qualified engineer to ensure electrical safety at site.

2. GENERAL

- (1) The Contractor shall nominate a qualified electrical supervisor whose name and qualifications shall be submitted in writing to the Engineer for review, who shall be solely responsible for ensuring the safety of all temporary electrical equipment on Site.
- (2) The Contractor shall not install or operate any temporary electrical systems on the Site until this electrical engineer is appointed and has commenced duty.
- (3) The name and contact telephone number of the qualified electrical engineer shall be displayed at the main distribution board for the temporary electrical supply so that he can be contacted in case of an emergency.
- (4) The Contractor shall submit details of all base electrical circuits, characteristics and the equipment for all temporary electrical installations together with details of the temporary electrical equipment(s) to the Engineer for his consent,
- (5) Temporary electrical Site installations and distribution systems shall be in accordance with the rules and regulation applicable for and/or applied by:
 - a. The local electrical company supply rules;
 - b. Wiring regulations;
 - c. Distribution of electricity on construction and building sites;

- d. Distribution assemblies for electricity supplies for construction and building sites;
- e. Regulations for fire safety norms and requirements for civil works; and
- f. Any other applicable Indian standards and regulations.

2.1 Material, Appliances and Components

All material, appliances and components used within the distribution system shall comply with Indian standards.

2.2 Design Considerations

- (1) Distribution equipment utilized within the temporary electrical distribution system shall incorporate the following features:
 - a. Flexibility in application for repeated use;
 - b. Suitability for transport and storage;
 - c. Robust construction to resist moisture and damage; and
 - d. Safety in use.
- (2) All cabling shall be run at high level wherever possible and be firmly secured to ensure it does not present a hazard or obstruction to people and equipment.

2.3 Mains Voltage

"SHE Manual" of DFCC provided in "Reference Documents – Part 4 of Bidding Documents" stipulates certain voltages for different works. In case of conflict of provisions regarding voltage under this Appendix, those specified in the SHE Manual shall prevail.

- (1) The Site mains voltage shall be 400V/ 3 phases 4-wire system 50 Hz.
 - a. Single phase voltage shall be 230V supply.
 - b. Reduced voltages shall conform to Indian Standards.
- (2) The following voltages shall be adopted for typical applications throughout the distribution systems:
 - a. Fixed plant – 400V/ 3 phase;
 - b. Movable plant fed by trailing cable – 400V /3 phase;
 - c. Installations in Site buildings - 230V/240V /1 phase;
 - d. Fixed flood lighting - 230V/240V 1 phase;
 - e. Portable and hand held tools – 12V, 24V or 36V /1 phase;
 - f. Site lighting (other than flood lighting) – 12V, 24V or 36V /1 phase; and
 - g. Portable hand-lamps (general use) – 12V, 24V or 36V /1 phase.
- (3) When the low voltage supply is energized via the Indian Railway's power supply, any power utilized from that source shall be either 400V 3 phases or 230V/240V single phase as appropriate and the Contractor shall carry out any conversion that may be necessary to enable him to use power from that source.
- (4) Protection of Circuits

- a. Protection shall be provided for all main and sub-circuits against excess current, under and over voltage, residual current and earth faults.
- b. The protective devices shall be capable of interrupting (without damage to any equipment or the mains or sub-circuits) any short circuit current that may occur.
- c. Discrimination between circuit breakers, circuit breakers and fuses shall be in accordance with the Indian Standards.

2.4 Earthing

- (1) Earthing and bonding shall be provided for all electrical installations and equipment to prevent the possibility of dangerous voltage rises and to ensure that faults are rapidly cleared by installed circuit protection.
- (2) Earthing systems shall conform to the following standards:
 - a. Wiring regulations;
 - b. Guide for safety in AC substation grounding.
 - c. Indian Electricity Rules

2.5 Plugs, Socket Outlets and Couplers

Low voltage plugs, sockets and couplers, as well as the high voltage couplers and 'T' connections shall be colour coded in accordance with, and conform to Indian Standards. All the Plugs and sockets used at construction site shall be IP 65 protected with Residual Current Circuit Breaker RCCB/ Earth Leakage Circuit Breakers (ELCB) to prevent Leakage of current and electrocution in Compliance to Indian Electricity Rule.

2.6 Cables Used for Temporary Works

- (1) Cables shall be selected after full consideration of the conditions to which they will be exposed and the duties for which they are required.
- (2) Temporary Supply cables shall be minimum 3-core (P + N + distinctly colored PE) for single phase power distribution and in accordance with Indian Standards with TNS Earthing. Similarly. the cable used for 3-phase power distribution shall also conform the TNS earthing system. Earthing/ armoured wire shall be retained at zero potential. All the cables used at site will be joint-less. Joints if any shall be made through proper Jointing Kit in IP 65 enclosure to prevent accidental touch and electrocution of the staff/ public. All the cables laid underground at worksite shall be armoured. All the cables shall conform BIS and have Marking conforming to standards. No cable with damaged insulation shall be used and the cable damaged if any shall be removed immediately and ensured by the Project Manager.
- (3) For supplies to mobile or transportable equipment where operation of the equipment subjects the cable to flexing, the cable shall conform to Indian Standards as well as one of the following specifications appropriate to the duties imposed on it:
 - a. Flexible cables for use at mines and quarries;
 - b. Rubber insulated cables for electric power and lighting; and

- c. Insulated flexible cords and cables.
- (4) Where low voltage cables are to be used, reference shall be made to Indian Standards, the following specifications shall also be referred to particularly for underground cables:
 - a. for armoured PVC insulated cables; and
 - b. flexible cables for use at mines and quarries.
- (5) All cables which have a voltage to earth exceeding 65V (except for supplies from welding transformers to welding electrodes) shall be metal sheathed and/or armoured which shall be continuous and effectively earthed. In the case of flexible or trailing cables, such earthed metal sheath and/or armour shall be in addition to the earth core in the cable and shall not be used as the sole earth conductor.
- (6) Armoured cables having an over-sheath of polyvinyl chloride (PVC) or oil resisting and flame retardant compound shall be used whenever there is a risk of mechanical damage occurring.
- (7) For resistance to the effects of sunlight, overall non-metallic covering of cables shall be black in colour.
- (8) Cables with an applied voltage to earth exceeding 12V but not normally exceeding 65V shall be insulated and sheathed with a general purpose or heat resisting elastomer.
- (9) All cables that are likely to be frequently moved in normal use shall be flexible cables. Flexible cables shall be in accordance with Indian Standards.
- (10) The Welding earthing cable shall be insulated and conform to relevant standards. Other than the insulated Cables shall not be used at work site to avoid any leakage and electrocution at worksite.

2.7 Lighting Installation

- (1) Where Site works are required during the night, the lighting circuits shall be run separate from other sub-circuits and shall be in accordance with Indian Standards.
- (2) Voltage shall not exceed 55V to earth except when the supply is to a fixed point and where the lighting fixture is fixed in position.
- (3) Luminaries shall have a degree of protection not less than IP 54.
- (4) In particularly onerous environments where the luminaries are exposed to excesses of dust and water, a degree of protection to IP 65 shall be employed.
- (5) The Contractor shall provide a minimum lighting level of 200 lux by localised lighting in all areas where required for carrying out the works.
- (6) Wherever a risk of damage may occur, luminaries shall be mechanically protected against impact damage by use of wire guards or other such devices.

2.8 Electric Motors

- (1) Totally enclosed fan cooled motors to Indian Standards shall be used.
- (2) Motor control and protection circuits shall be as stipulated in Indian Standards.

- (3) Emergency stop switches shall be provided for all machinery.

2.9 Inspection and Testing

Electrical installations on Site shall be inspected and tested in accordance with the requirements of the wiring regulations.

2.10 Maintenance

- (1) Regular maintenance and checking of control apparatus and wiring distribution systems shall be carried out by a engineer or electrician (duly qualified to carry out the said checks) to ensure safe and efficient operation of the systems.
- (2) All portable electrical appliances shall be permanently numbered (scarf tag labels or similar) and a record kept of the date of issue, date of the last inspection and the recommended inspection period.

2.11 Metering

The Contractor shall install and register a separate energy meter for each supply of electricity from the applicable suppliers. The Contractor shall pay all required charges for the supplied electric energy.

(End of Appendix-4)

APPENDIX-5: REQUIREMENT FOR CONSTRUCTION

1. THE SITE

1.1 The Site details and locations are defined in the respective Particular Specifications (Volume 3 & 4) and in Part 4 – Reference Document of the Bid Document.

1.2 Use of the Site and Work Areas

1.2.1 The Site or Contractor's Temporary Facilities including Contractor's equipment shall not be used by the Contractor for any purpose other than for carrying out the Permanent or Temporary Works or Contractor's Temporary Facilities except that with the consent of the Engineer in writing.

1.2.2 The Employer shall hand over the Site to the Contractor free of encumbrances as per the agreed schedule. Once the Site is handed over to the Contractor, its integrity, safety and security etc. shall be the responsibility of the Contractor until the issue of Taking Over Certificate unless otherwise directed by the Engineer.

1.2.3 The location and area of material stacking and each stockpile of material including excavated material within the ROW shall be subject to approval by the Engineer. Stockpiles of material and stacking of steel etc. shall be maintained at all times in a stable condition.

1.2.4 In case spare land is available with the Employer the same can be handed over to the Contractor free of cost for the purpose of establishing temporary construction depot(s). However, whenever Employer requires this portion of land back, the same shall be handed over to the Employer with a month's notice at no extra cost / compensation to the Contractor.

1.3 Access to the Site

1.3.1 The Contractor shall make its own arrangements, at their own cost, subject to the consent of the Engineer, for access required to the Site.

1.3.2 The existing access roads if used by the Contractor for transport of his men, material and equipment shall be maintained by the Contractor to a satisfactory level to allow uninterrupted flow of traffic including the public traffic otherwise using these roads including cleanliness.

1.3.3 In addition, the Contractor shall ensure that access to every portion of the Site is continuously available to the Employer's Personnel and the Engineer and other entities authorized by the Employer / Engineer.

1.4 Access / Egress through Work Areas

The Contractor shall be responsible for ensuring that any access or egress through the Work Areas boundaries are controlled so that no disturbance to residents or damage to public or private property occur as a result of the use of such access or egress by his employees and Sub-Contractors.

1.5 Survey of the Work Areas

In addition to the validation of the data provided by the Employer and additional survey, as considered necessary by the Contractor, the Contractor shall carry out survey to identify any encumbrance infringing the Permanent Works and shall advise the Engineer

accordingly. The survey shall be carried out before the site clearance, wherever possible and in any case prior to the commencement of the Work in any Work Areas. The survey shall be carried out by the Contractor and agreed with the Engineer.

1.6 Temporary Fencing and Signboards

- 1.6.1 The Contractor shall erect hoardings, temporary fences and/or gates around the Work Areas specifically near the populated areas to prevent entry by unauthorized persons to his Work Areas as long as they are deemed to be necessary. The Contractor shall issue, all his personnel including the personnel working with sub-contractor(s), identity cards for entering the Work Areas. Necessary arrangements to ensure that no unauthorized person enters the Work Areas and shall be made by the Contractor by way of posting of security guards. Use of hoardings / temporary fencing / signboards etc. shall not be permitted for any kind of advertisement / publicity etc., without the consent of the Engineer.
- 1.6.2 For executing the work adjacent to running traffic areas, the Contractor shall erect fences and gates around its areas of operations to prevent accidents as well as post competent flagmen/ guards. The Contractor shall submit proposals for the fencing of the Work Areas to the Engineer for review. No Work shall be commenced in any Works Area until the Engineer has been satisfied that the fencing installed by the Contractor is sufficient to prevent any unauthorized entry.
- 1.6.3 Project signboards shall be erected at the Site 28 days prior to the commencement of the construction activities of the relevant Work Area. The type, size and locations of project signboards shall be agreed by the Engineer before manufacture and erection of the signboards.
- 1.6.4 The consent of the Engineer shall be obtained before hoarding, fences, gates or signs are removed. Hoardings, fences, gates and signs which are to be left in positions after the issue of Taking-Over Certificate shall be repaired and repainted as instructed by the Engineer.
- 1.6.5 Hoarding/fencing can be reused after removing from one place to other locations / sites provided they are in good condition and consented by the Engineer.
- 1.6.6 Damage/worn-out fencing/hoarding shall be replaced by the Contractor within 24 hours. Engineer's decision regarding need for replacement shall be final and binding and if no action is taken by Contractor, the same shall be got done by the Engineer and cost of any repair shall be deducted by the Engineer from any payment due to the Contractor.
- 1.6.7 The types, sizes and locations of project signboards shall be agreed with the Engineer before manufacture and erection. Other advertising signs shall not be erected on the Site.
- 1.6.8 Hoardings, fences, gates and signs shall be maintained in good order by the Contractor until the completion of the Works, whether such hoardings, fences, gates and signs have been installed by the Contractor or by others and transferred to the Contractor during the period of the Works.
- 1.6.9 All hoardings, fences, gates and signs installed by the Contractor shall be lit during night or low visibility as required and advised by the Engineer and removed by the Contractor upon the completion of the Works, unless otherwise directed by the Engineer.

1.7 Clearance of the Site

All Temporary Works shall be removed by the Contractor upon issue of the Taking Over Certificate except the Temporary Facilities with necessary utility services, required for completing his obligations after the issue of Taking-Over Certificate unless otherwise directed by the Engineer. The Contractor shall dismantle and remove all Temporary Works and the land in which the Temporary Works have been located, shall be properly treated, to complete the Works as shown in the Construction Drawings.

2. CONSTRUCTION-PRECAUTIONS

2.1 Precautions While Working In Close Proximity of Existing Indian Railway Track

a. General

- i Prior to the commencement of construction operations, the Contractor shall obtain all necessary clearance(s) from the concerned authorities.
- ii Any construction activity involving the existing embankment/formation/running track of the Indian Railways shall be carried out only with the prior specific authorization of the Engineer.

b. Works being executed outside running lines are further divided into following 3 sub-groups depending upon their distance from the IR track:-

- i Works being done within 3.5 meters from center of track.
- ii Works being done between 3.5 meters and 6 meters from center of track
- iii Works being done beyond 6 meters from center of track

If a work site is located far away from the existing track but the vehicles in connection with the work are required to ply within the distance from center of track as mentioned above, it will be construed that the work is being executed under above classification.

c. Works being done within 3.5 meters from center of track

All works planned within 3.5 meters from center of running line or which involve working of machineries and vehicles within this zone, are to be done essentially under block protection and necessary safety precautions for protection of track as per para 806 and 807 of IRPWM shall be taken. This includes even occasional plying of vehicles/ machineries for short durations.

d. Works being done between 3.5 meters and 6 meters from center of track

Following precautions shall be taken when works are required to be done between 3.5 meters to 6 meters from track center or machines/vehicles are required to work/ply within this zone.

- i Before start of work, demarcation should be done parallel to running track at a distance of 3.5 meters from center of track in advance, as per sketch B, by 150 mm wide white line of lime. Any work or movement of machinery infringing this line will need block protection. Barricading should be put up at such locations, as per sketch C, to ensure that even by carelessness or oversight, vehicles do not infringe fixed dimensions. Barricading design shall be approved by the Engineer.

- ii In case vehicles have to ply or machineries have to work within this zone, railway's and contractor's supervisors be positioned as shown in sketch D except mentioned in para (iii) below:

SAFTY/PROTECTION ARRANGEMENT SKETCHES

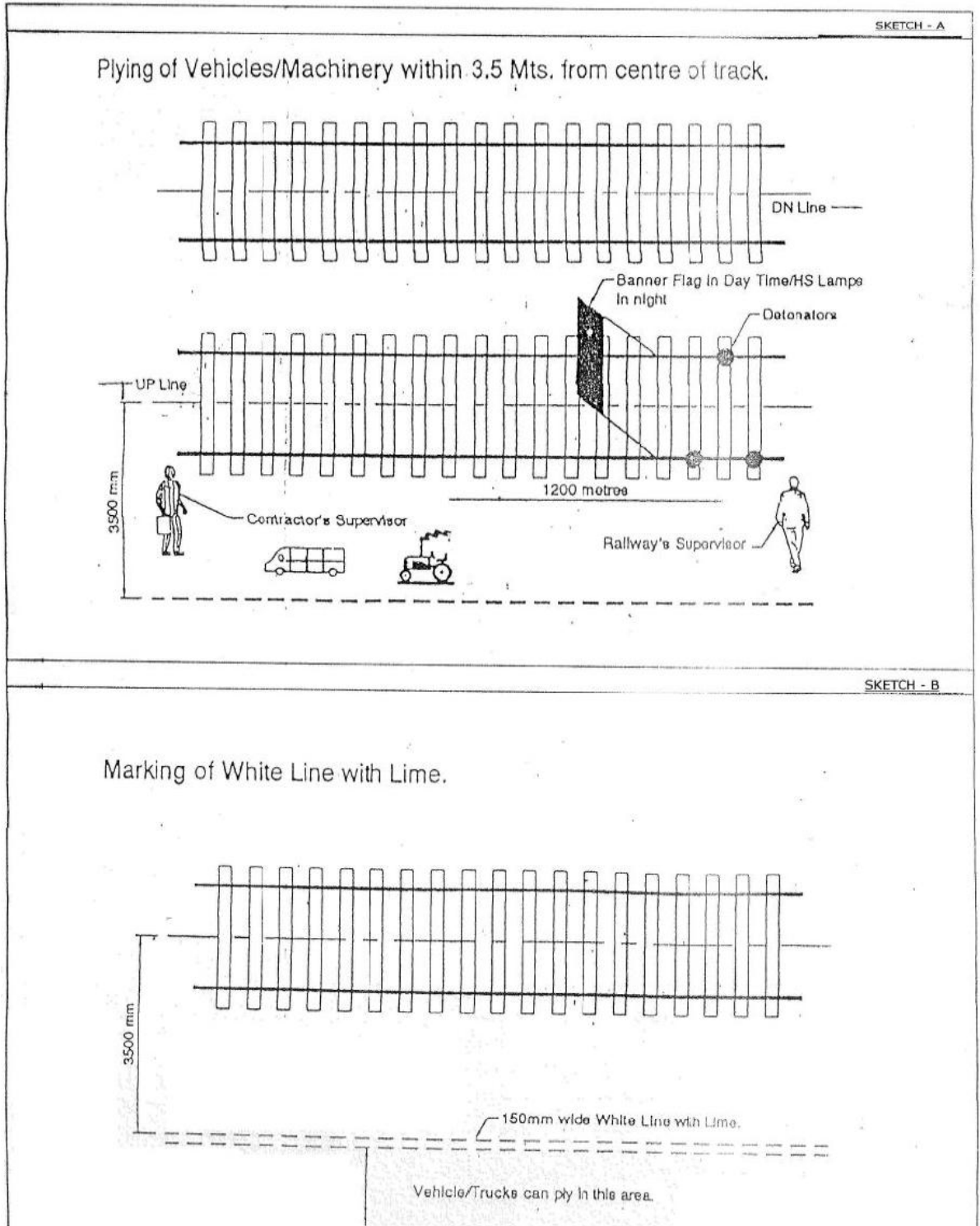

SKETCH-C

BARRICADING FOR SAFETY AT WORK SITE

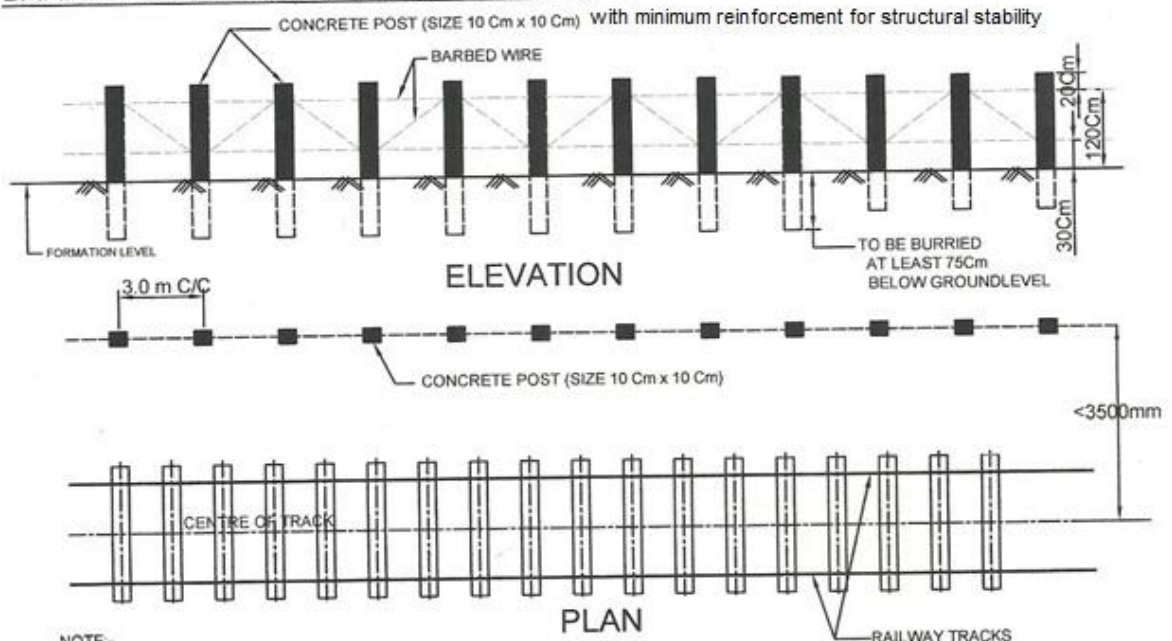

NOTE-
 BARRICADING OF WORK SITES SHOULD BE PROVIDED AS FAR FROM CENTRE LINE OF TRACK AS POSSIBLE BUT NOT LESS THAN 3.5m FROM CENTRE LINE OF TRACK WHEN THE BARRICADING IS PROVIDED PARALLEL TO TRACK OF >3.5m FROM CENTRE LINE. BARRICADING PERPENDICULAR TO THE TRACK ALSO NEED TO BE PROVIDED AT TERMINATING ENDS UPTO 3.5M FROM CENTRE LINE OF TRACK TO AVOID MOVEMENT OF ANY ROAD VEHICLE BETWEEN BARRICADING AND THE TRACK.

SKETCH-B

Plying of Vehicles/Machinery between 3.5 Mts. to 6.0 Mts. from centre of track.

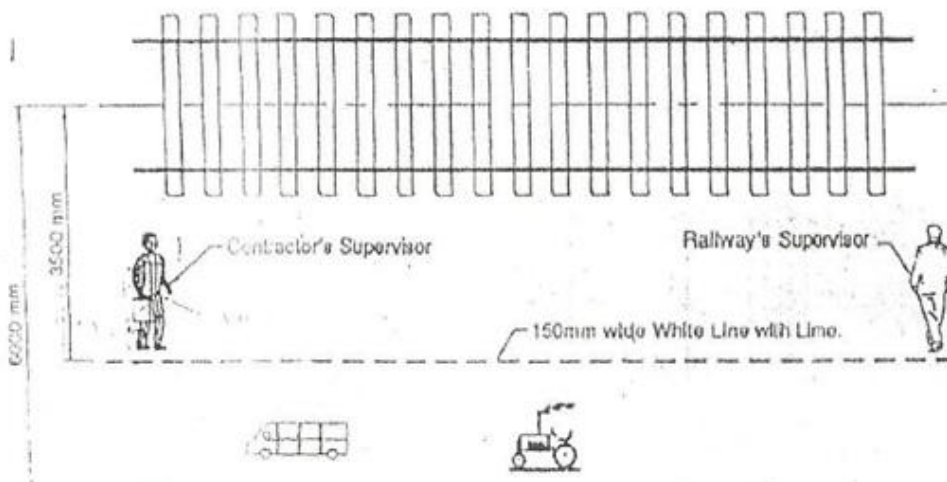

- iii Instead of a Railway supervisor it would be a responsible and trained staff of the Contractor as mentioned in para 2.1. d), ii above.
- iv Additional trained staff of the Contractor, as mentioned in para 2.1. d), ii above, shall be posted where turning of vehicles is required during working .

- Location for reversing vehicles should be nominated and it should be selected in such a way that there is no danger to running trains at such a location. Such trained staff of the Contractor should be available with hand flag(s) so that vehicles do not come closer to track by 3.5 meters. Wherever vehicles have to take turn, it should be done in such a way that the driver is invariably facing the running track at all times.
- v Look out men should be posted along the track at a distance of 800 meters from location of work with red flag and to whistle in face of road vehicles and approaching trains. Look out men shall also be suitably trained staff of Contractor as mentioned in para 2.1. d), ii above.
- vi In addition to look out men, caution order needs to be issued to trains and speed restrictions imposed wherever considered necessary through Employer.
- vii Arrangements should be made to protect the track in case of emergency at work site.
- viii All temporary arrangements required during execution should be done in a manner that moving dimension is not infringed.
- ix Individual vehicle/machinery shall not be left unattended at site of work. If it is unavoidable and essential to stable it near running track, it shall be properly secured and manned even during non-working hours with all arrangements to protect the track from infringement.
- x Any material unloaded or shifted along the track should be kept clear of moving dimensions and stacked at a specified distance from running track.
- xi Movement of vehicle/working of machineries should be prohibited at night. However, in case of emergency when night working is unavoidable, adequate lighting shall be provided with all protection measures as mentioned above in full force. All night working near IR track shall require Engineer's prior approval.
- xii The work site should be suitably demarcated to keep public and passengers away. Necessary signage, boards, such as "work in progress" etc. should be provided at appropriate location to warn public/passengers.
- xiii Contractor's drivers/operators handling vehicles/machineries shall be issued a fitness certificate by the safety officer of the Contractor after educating them about safety norms and after taking assurance in writing for working within vicinity of railway's track.
- xiv While working on cuttings with machineries or when there is movement of vehicles above cutting, if there is possibility of any of the following circumstances, work has to be done under block protection:
- Any possibility exists for machinery/vehicle after toppling/due to loss of control come over track or infringe it.
 - Chance of machineries/vehicles to come within 3.5 meters from track center though working beyond it.

e. Works being done beyond 6 meters from center of IR track.

No precautions are needed except in cuttings or where the work can affect train running in any way.

3. CARE OF THE WORKS

3.1 General

- a. Unless otherwise permitted by the Engineer, all works shall be carried out in dry conditions.
- b. The Works, including material for use in the Works, shall be protected from damage due to water. Water on the Site and water entering the Site shall be promptly removed by temporary drainage or pumping system or by other methods capable of keeping the Works free of water.
- c. The discharge points of the temporary drainage / pumping systems shall be as per the consent of the Engineer and shall meet all the requirements as described in Part 4 – Reference Document – DFCC SHE Manual.
- d. The methods to be used for keeping the Works free of water shall be carefully chosen so that any settlement of or damage to the Works and / or adjacent existing structures should not occur.

3.2 Protection of the Works from Weather

- a. Works shall not be carried out in weather conditions that may adversely affect the Works unless proper protection is provided to the satisfaction of the Engineer.
- b. Permanent Works including material for such works, shall be protected from exposures of weather conditions that may adversely affect such Permanent Works or material.
- c. During construction of the Works, storm restraint systems shall be provided where appropriate. These systems shall ensure the security of the partially completed and ongoing stages of construction in all weather conditions. Such storm restraint systems shall be installed as soon as practicable and shall be compatible with the site conditions.
- d. The Contractor shall at all times, program and carry out the Works duly ensuring protective arrangements such that the Works can be made safe in the event of storms.

3.3 Protection of the Finished Works

The finished Works shall be protected from theft, pilferage or any damage that could arise due to any reason. If required, sections of route may be antitheft charged at 2.2kV but only on following a street protocol as laid down in relevant portion of ACTM and as modified for use on DFCC by the Employer and after having completed all steps laid down and after Engineer's approval.

4. HANDLING OF CHARTERED / UNCHARTERED PUBLIC UTILITY

- 4.1.1 All chartered/ unchartered utilities including the power lines 33 kV and below with in Right Of Way (ROW) of construction/ installation shall be removed and relocated by CST

Contractor. Relocation/ modification of utilities pertaining to Signaling and Telecommunication will be dealt by DFCC itself. Similarly, relocation/ modification of utilities pertaining to traction and transmission lines crossings above 33 kV will also be dealt by DFCC itself.

4.1.2 In case the Engineer decides the work of removal of any uncharted utility to be done by the Contractor, this shall be treated as a Variation to the Contract and shall be dealt as per the provisions for dealing with Variations in Contract. Contractor shall be paid as per actual work done for removal of uncharted utilities based on the Variation approved by the Engineer, on case to case basis.

4.1.3 Any other public utility which interferes the Works and is required to be relocated and/or diverted and which the Contractor interprets as is not inclusive in the Contract, the Contractor shall notify the Engineer of the details of the public utility. The Employer may decide to relocate such utilities either on their own or through any other agency including the Contractor (CP-105).

4.2 Other Interference

4.2.1 Alternative Access

Alternative access shall be availed / organized by the Contractor at his own cost through all public or private premises, when interference with the existing access occurs, to enable the Works to be carried out. The arrangements for the alternative access shall be as agreed by the Engineer and the concerned agencies. The permanent access shall be reinstated as soon as practicable after the Works are complete and the alternative access shall be removed and reinstated immediately as soon as it is no longer required. Proper signage and guidance shall be provided for the traffic / users regarding diversions.

4.2.2 Trees

Material, including excavated material, shall not be banked around trees. Trees shall be protected from damages at all times by the method(s) consented to by the Engineer. Unless otherwise consented to by the Engineer, trees shall not be trimmed or cut as stated in Part 4 – Reference Document - DFCC SHE Manual. However the contractor shall be required to prune the tree leaves coming in proximity of the energized OHE as per the Indian Railways Guidelines before taking over of the OHE assets by the Employer.

4.2.3 Removal of Trees, Graves and other Obstructions

Trees within ROW shall be cut by CST Contractor. If any tree, grave and other obstruction is required to be removed in order to execute the Works and such removal has not already been arranged for, the Contractor shall draw the Engineer's attention to them in good time to make necessary arrangement for such removal. The Contractor shall not itself remove them unless the Engineer has given consent.

4.2.4 Protection of the Adjacent Structures and Works

The Contractor shall take all necessary precautions to protect the structures or works being carried out by others adjacent to and, for the time being, within the Site from the effects of vibrations, undermining and any other earth movements or the diversion of water flow arising from its work.

4.3 Use of Roads

4.3.1 General

- a. Measures shall be taken to prevent the excavated material, silt or debris from entering gullies on roads and footpaths, entry of water to gullies shall not be obstructed.
- b. All surfaced roads (public / private) which are chosen for construction activities in the Traffic Management Plan, shall not be used by the Contractor's tracked vehicles unless protection against damage is provided by the Contractor and / or appropriate remedial measures are prepared and agreed with the concerned parties.

4.3.2 Traffic Management Plan

The Contractor shall develop a detailed Traffic Management Plan for the Works under the Contract. The purpose is to develop a Traffic Management Plan to cope with the traffic disruption as a result of construction activities by identifying strategies for traffic management on the roads and neighborhoods impacted by the construction activities. The Contractor shall implement the Traffic Management Plan throughout the whole period of the Contract. The basis for the Plan shall take into consideration four principles:

- a. to minimize the inconvenience of road users and the interruption to surface traffic through the area impacted by the construction activities;
- b. to ensure the safety of road users in the impacted area;
- c. to facilitate access to the Work Area, and to maintain scheduled construction progress.
- d. to ensure traffic safety at each Work Area.

Wherever applicable, the Contractor shall obtain necessary approval from the transport authorities and police department for temporary traffic arrangement and control on public roads.

4.4 Reinstatement of Public Roads And Foot Paths

- a. Temporary diversions, pedestrian access and lighting, signage, guarding and traffic control equipment, if any, shall be removed immediately when these are no longer required for the construction activities.
- b. Roads, footpaths and other items affected by temporary traffic arrangements and control shall be reinstated to the same condition as existed before the work started or as consented by the Engineer immediately after the relevant work is complete or at other times permitted by the Engineer.
- c. Wherever required, the Contractor shall submit his plan for reinstatement to relevant authorities and obtain their prior approval to carry out the work

4.5 Security

- 4.5.1 The Contractor shall be responsible for the security of the Site for the full time till the issue of Taking Over Certificate except for specific cases of railway envelope after it is handed over to the Employer and / or as directed by the Engineer. The Contractor shall set up and operate a system whereby only those persons entitled to be involved in the construction activities in the Contract could enter the Work Areas. For the Site located

near the populated areas, the Contractor shall, with the consent of Engineer provide the specific points only at which entry through the security fence can be effected and shall provide gate(s) and barrier(s) at such point(s) of entry and maintain security guard throughout twenty four (24) hours duration all the day. The Contractor shall also arrange for such other security personnel and patrols elsewhere as may be necessary to maintain security.

- 4.5.2 The Contractor shall maintain all site boundary fences, wherever provided, in good condition and shall so arrange site boundary fences and security measures that the drainage arrangement is not affected. Notices shall be displayed at intervals around the Work Areas to warn the public of the dangers of entering the Work Areas
- 4.5.3 During the progress of the Works, the Contractor shall maintain such additional security patrols over the Works Areas as may be necessary to protect his own and his sub-contractor's facilities and equipment as well as the Works. In addition, the Contractor shall coordinate and plan the security of both the Works under the Contract and works of the other contractors including Interfacing Parties requiring access to the Site.
- 4.5.4 In order to operate such a security system, it will be necessary to institute the issue of unique passes to personnel and vehicles entitled to be on the Work Areas and a system of separately identifiable according to the shifts being worked on the Work Areas. The Contractor shall, at the outset, determine together with the Engineer, a system including the design of passes to suit the requirements of the foregoing and to suit the methods of activities to be adopted by the Contractor for these purposes. The Contractor shall, at all times, ensure that the Engineer has an up to date list of all persons entitled to be on each Work Area at any time. The Contractor shall also introduce a system for issue of passes to any outsider or person/vehicles belonging to agencies other than Employer/Engineer who may have to visit each of the Work Areas in connection with the Works.
- 4.5.5 The Contractor shall liaise with the other contractor(s) and the Interfacing Parties responsible for security of the adjacent areas and ensures that coordinated security procedures are operated, in particular in respect of vehicles permitted to pass through the Site and/or the adjacent sites. The security of the erected Conductors of the OHE as an antitheft charging with 2.2 kV supply shall be carried out in full liaison with other contractors.
- 4.5.6 Security and checking arrangements, as considered necessary shall be provided.

4.6 Contractor's Labour Camp

4.6.1 General

The Contractor shall comply with all requirements as detailed in Part 4 – Reference Document – DFCC SHE Manual of the Bid Document.

4.6.2 Provision of Labour Camp

- a. The Contractor shall, at his own expense, make adequate arrangements for the housing, supply of drinking water and provision of bathrooms, latrines and urinals, with adequate water supply for his staff and workmen at the location authorized by Engineer.
- b. No labour camp shall be allowed at Site without the consent of the Engineer / Employer or any unauthorized place. The Contractor shall prepare a detailed labour camp plan to obtain the consent from the Engineer's.

- c. The Contractor, at his own cost, shall maintain all camp sites clean and sanitized.
- d. The Contractor shall obey all health and sanitary rules and regulations and carry out at his cost, all health and sanitary measures that may from time to time be prescribed by the Local/Medical Authorities and permit inspection of all health and sanitary arrangements at all times by the Engineer and the staff of the local municipality or other authorities concerned.
- e. Should the Contractor fail to provide adequate health and sanitary arrangements, these shall be provided by the Employer and the cost thereof recovered from the Contractor.
- f. The Contractor shall at his own cost, provide First Aid Stations as described in Employer's Requirement, Part 2, Section VI, Volume I, Chapter-9 of this GS and Part 4 – Reference Document – DFCC SHE Manual.
- g. The Contractor shall at his own cost, provide the following minimum requirements for fire precautions at suitable locations complying with the requirements of applicable Codes:
 - i. Portable Fire Extinguishers.
 - ii. Manual Fire Alarms.
 - iii. Water Supply for use by the Fire Service personnel.
- h. The Contractor shall at his own cost provide necessary arrangements for keeping the camp area sufficiently lighted to avoid accidents to the workers.
- i. The Contractor shall ensure that electrical installations are done by qualified electricians and as per the applicable Codes & Standards and these installations shall be maintained and daily maintenance records shall be available for inspection of the Engineer on demand.

4.7 Camp Discipline

- a. The Contractor shall take requisite precautions and use his best endeavors to prevent any riotous or unlawful behavior by or amongst his workmen and others, employed directly or through sub-contractors.
- b. These precautions shall be for the preservation of the peace and protection of the inhabitants and security property in the neighborhood of the Works.
- c. The sale of alcoholic drinks or other intoxicating drugs/ beverages in any labour camp or in any of the buildings or encampments owned or occupied by, or within the control of the Contractor or any of his employees directly or through sub-contractors employed on the work, shall be strictly prohibited and the Contractor shall ensure strict compliance.
- d. The Contractor shall also ensure that no labour or employee is permitted to work at the site in an intoxicated state or under the influence of drugs.
- e. The Contractor shall remove, from his camp, such labour and their families, who refuse protective inoculation and vaccination when called upon to do so by the Engineer on the advice of the Medical Authority.
- f. Should Cholera, Plague or any other infectious disease breaks out, the Contractor shall, at his own cost, burn the huts, bedding, clothes and other belongings of or

used by the infected parties.

- g. The Contractor shall promptly erect new accommodation on healthy sites as required by the Engineer within the time specified by the Engineer, failing which the work may be done by the Employer and the cost thereof recovered from the Contractor.

4.8 Labour Accommodation

- a. The Contractor shall provide living accommodation for all staff employed by himself or his subcontractors that is equal to or exceeds the minimum criteria established in the following sub-sections.
- b. The buildings shall be constructed so as to have a minimum life of not less than the period of the Contract.
- c. The roofs shall be leak-proof and laid with suitable inflammable material permissible for residential use under local regulations and for which the consent of the Engineer has been obtained.
- d. Each unit shall have suitable ventilation with all doors, windows and ventilators provided with security leaves and fasteners and back to back units are to be avoided.
- e. The Contractor shall provide a suitable cooking area.
- f. The number of common toilet/bath/urinals shall be provided as per the provision in Part 4 - Reference Document – DFCC SHE Manual.

4.9 Water Supply

- a. The Contractor shall make his own arrangements to provide adequate potable water supply in the Camp.
- b. Where piped water supply is available, supply shall be at stand posts and where the supply is from wells or river, storage tanks of metal or other approved material shall be provided.
- c. The Contractor shall also, at his expense, make arrangements for the provision and laying of water pipe lines from the existing mains wherever available.

4.10 Drainage

- a. The Contractor shall provide efficient arrangements for draining away surface water so as to keep the camp neat and tidy.
- b. Surface water shall be drained away from paths and roads and shall not be allowed to accumulate into ditches or ponds where mosquitoes can breed.

4.11 Sanitation

- a. The Contractor shall make arrangements for conservancy and sanitation in the labour camps according to the rules and regulations of the Local Public Health and Medical Authorities.
- b. The Contractor shall provide a sewage disposal system that is adequate for the number of residents in the camp and which meets the norms of the local authorities.
- c. Provision of the latrines and wash places shall be in accordance with Part 4 –

Reference Document – DFCC SHE Manual and as per applicable Codes and Standards. However the layout shall be subject to consent by the Engineer.

- d. The Contractor shall be responsible for maintaining all latrines and wash places on the Site in a clean and sanitary condition and for ensuring that they do not pose a nuisance or a health threat.
- e. The Contractor shall also take such steps and make such provisions as may be necessary or as directed by the Engineer to ensure that vermin, mosquito breeding etc. are, at all times fully controlled.

(End of Appendix-5)

APPENDIX-6 - ENVIRONMENTAL PROTECTION REQUIREMENTS

1. MEASURES FOR THE MITIGATION OF ENVIRONMENTAL IMPACTS

This section describes mitigation measures to be taken in pre-construction, construction stage and defect notification stage against environmental impacts. Compliance of applicable statutory laws is essential. All applicable mitigation measures as described herein are to be adopted for land, water, air, noise, vibration and for protection of flora, fauna, health and safety issues. Monitoring and mitigation measures as elucidated in this appendix shall be the responsibility of the contractor (CP – 105), wherever applicable. In case of any conflict, detailed Environmental Assessment Report given in Part-4, Bidding Documents shall prevail.

2. GENERAL

- (1) Various provision mentioned in this Appendix shall be applicable for relevant works carried out by System Contractor.
- (2) The Contractor shall develop its own Environment Management Plan (EMP), as a part of the Contractor's Safety Health and Environment Plan (SHE) and submit to the Engineer for approval in accordance with the EIA report (included in Part 4 of the Bidding Documents), relevant Government of India Legislation like Pollution Control Board, various environmental monitoring agencies of Government etc.
- (3) The Contractor's detailed Designs for the Works and operations during construction shall conform to all Indian Environmental Laws and the EIA report (included in Part 4 of the Bidding Documents) at all times.
- (4) The current national standards established by the Indian Government for control of environmental pollutants such as air, water, noise and visual impacts/aesthetics shall be followed for compliance during pre-construction construction and defect notification stages.
- (5) The Contractor's designs and plans shall be based upon the applicable provisions in the Environmental Management Plan of DFCC, Environmental Impact Assessment (EIA) Report and Social Impact Assessment (SIA) Report / Resettlement Action Plan (RAP) of DFCC provided in "Reference documents - Part 4 of Bid Documents," These documents also contain organization framework of DFCC, roles and responsibilities of various stakeholders for implementation of effective EMP.
- (6) The Contractor shall ensure that proper and adequate provisions to this end are included in all sub-contracts placed by him.
- (7) The provisions of this Appendix however, shall not be applicable in the case of emergency works necessary for saving of life and property or safety of the Works which shall have prior approval of Engineer in all cases.
- (8) The Contractor shall undertake environmental monitoring as required under the contract, the Employer's EIA, SIA / RAP and supplement to the EIA, SIA / RAP recommendations.

- (9) The Contractor shall prepare a plan for self-monitoring over the course of the project and submit to the Engineer for approval.
- (10) The Contractor shall ensure that audits of all the activities detailed in his EMP are carried out at monthly intervals and reported in the Monthly Reports to ensure the continuing effectiveness and compliance with the EMP. These reports shall inter – alia cover the details as indicated in Appendix – 8.
- (11) The Contractor shall make available on request any document which relates to his recent internal audits.
- (12) The Engineer may conduct quarterly audits of the Contractor's EMP and its effective implementation on the works site.
- (13) During the audit the Contractor shall provide a suitable number of qualified staff as directed by the Engineer to assist the Engineer during the audit.
- (14) Requirements established in the EMP specifications shall apply to all sites and all activities of the Contractor, including the detailed Designs of the Systems works, and shall supplement the Employer's Requirements.
- (15) In the EMP the Contractor shall appoint a suitably qualified manager responsible for the environmental as well as a support team to assist this manager. Roles and responsibilities and key communication links must be highlighted to ensure responsibility for implementing the EMP.
- (16) The project may be a source of electromagnetic fields by transmission of electrical energy and the negative influences of the electromagnetic fields shall be taken into account with respect to clearances to and locations of the new Traction Sub Stations (TSS) and Over Head Transmission Lines.
- (17) The Contractor shall ensure that its Environment Plan documentation includes but is not limited to the provisions covered in this Appendix.

3. ENVIRONMENTAL MANAGEMENT PROCESS

Environmental management is based on the potential impacts assessed for the project. Assessment of potential impacts is based on the review of secondary data substantiated by site visits – environmental monitoring, public consultation, household survey and discussion with concerned Govt. Dept. The implementation of Environmental Management Plan (EMP) requires the following:-

- a. An organizational structure
- b. Assign responsibilities
- c. Define timing of implementation
- d. Define monitoring responsibilities

4. EMP DURING CONSTRUCTION

The project activities shall be executed in a phased manner, pre-construction phase, construction phase and operation phase. The major activities to be undertaken during construction phase are described below.

The environmental issues during construction phase generally involve quality, safety and public health issues. The Contractor is required to comply with the laws with respect to environment protection, pollution control, forest conservation, safety and any other applicable laws. Environmental pollution control during the construction phase shall be the responsibility of the Contractor. EMP is an executable part of project and the activities are to be guided, controlled, monitored and managed as per the provisions provided.

5. SOCIAL IMPACT MANAGEMENT PLAN (BY DFCCIL)

DFCCIL is responsible for implementation of Social Impact Management & Resettlement Action Plan (RAP). Rehabilitation of PAFs and removal of affected structures shall be responsibility of DFCCIL.

6. LAND ACQUISITION / DIVERSION PLAN

By DFCCIL: Acquisition of land is the responsibility of DFCCIL.

- a. At the outset Right of Way (RoW) along the entire DFC alignment has been established and confirmed from the State Forest, Agriculture and Land Revenue Departments.
- b. Diversion of forest land is ensured for the project by DFCCIL in compliance to Forest Conservation Act, 1980.
- c. The acquisition of land and private property shall be carried out in accordance to the Resettlement Action Plan (RAP).

By Contractor: Where temporary land is acquired by the Contractor for setting up labour camp, placing of construction related equipment, dumping of wastes, stacking of excavated earth, etc., the Contractor shall be responsible for such land acquisition/ hiring from the rightful owners following applicable procedures / rules, compensation / rent thereof and implementation of EMP provisions for the same.

7. ADHERENCE TO ALL APPLICABLE LABOR LAWS

It shall be the Contractor's responsibility for compliance of all labour laws and regulations (See Appendix-9). Besides in case of migrant workmen:

- Such inter-state migrant workmen are oriented to the customs, traditions and practices prevalent in the local area, particularly in tribal inhabited areas and avoids any conflict and/or tensions between migrant workmen and local workers and/or local community;
- there is no exploitation of labor, particularly of vulnerable groups such as tribals; and
- Also in case the percentage of migrant workmen exceeds 30% (to be mutually agreed), then s/he would employ a workmen supervisor from same community as the migrant workmen so as to facilitate /manage conflict and/or tensions, if any arise.
- Contractor shall provide for grievance resolution mechanisms for all workers

8. AVOIDANCE OF NUISANCE

- (1) The Contractor shall take all precautions to avoid any nuisance arising from his operations. This shall be accomplished, wherever possible by suppression of nuisance at source rather than abatement of the nuisance once generated.
- (2) The Contractor shall ensure that the work place is free of trash, garbage, debris and weeds. He shall provide and ensure proper uses of refuse containers to ensure that rodents, insects and other pests are not harbored and attracted.
- (3) The Contractor shall provide a dedicated team of workers at each work site who shall be solely employed to keep the site and its surroundings in a clean condition and maintain a good standard of house-keeping on the site.
- (4) All vehicles leaving the site shall have their wheels washed to prevent any soil or other material from contaminating the public roads.
- (5) The Contractor shall promptly transport all excavation disposal material of whatever kind so as not to delay work on the project. Stockpiling of material shall only be allowed at sites designated by the Engineer.
- (6) The Contractor shall protect structures, utilities, pavements and other facilities from disfiguration and damage.
- (7) The Contractor's temporary dumping areas shall be maintained by the Contractor till the material are re-utilized for back-filling or any other purpose as per instructions of Engineer

9. CONSTRUCTION / LABOUR CAMP MANAGEMENT

During the construction phase, proper construction camp development plan has to be formulated to control degradation of the surrounding landscape due to the location of the proposed construction camp. The Contractor must provide, construct and maintain necessary living condition and ancillary facilities as detailed in Appendix - 4 and shall comprise the following:

- (1) Sufficient supply of potable water must be provided at camps and working sites. If the drinking water is obtained from the intermittent public water supply, then storage tanks must be provided. All water supply storage may be sufficiently away from the toilets or drains.
- (2) Adequate and clean washing and bathing facilities must be provided that also have sufficient drainage.
- (3) Adequate sanitary facilities may be provided within every camp. The place must be cleaned daily and maintain strict sanitary conditions. Separate latrine must be provided for women. Adequate supply of water must also be provided.
- (4) The contractor must ensure that there is proper drainage system to avoid creation of stagnant water bodies.
- (5) Periodic health checkups may be conducted. These activities may be provided by the construction contractor in consultation with State Public Health Department. At every camp, first aid facilities with suitable transport must be provided as detailed in Employer's Requirement, Part 2, Section VI, Volume I, Chapter-9 of this GS.

- (6) Adequate supply of fuel in the form of kerosene or LPG may be provided to construction labour, to avoid felling of trees for cooking and other household activities. No open fires may be allowed in camps.
- (7) The sites should be secured by fencing and proper lighting.
- (8) The construction contractor shall ensure that all construction equipment and vehicle machinery are stored at a separate place / yard.
- (9) Fuel storage and refilling areas may be located 500 m away from the water bodies and from other cross drainage structures.
- (10) All the construction workers should be provided with proper training to handle potential occupation hazards and on safety and health which include the following:-
 - a. Environmental awareness program
 - b. Medical surveillance
 - c. Engineering controls, work practices and protective equipment
 - d. Handling of raw and processed material
 - e. Emergency response
- (11) Construction / labour camps shall be located away from forest areas, settlements, cultural heritage and historical sites and water bodies and dry river beds.
- (12) It should be ensured by the construction contractor that the camp area is cleared of the debris and other wastes after the completion of construction. On completion of construction, the land should be restored back to its original form to the satisfaction of DFCCIL

10. MITIGATION MEASURES OF LAND ENVIRONMENT DURING CONSTRUCTION

While DFCCIL is responsible for land acquisition, the Contractor shall be responsible for use of the land during construction. Hence, the Contractor shall take necessary measures as enumerated in the EMP to prevent/ arrest soil erosion, contamination.

Land acquisition, soil erosion and contamination of soil have emerged as major sources of impact on the land especially in urban areas and nearby watercourses. Proposed project aimed to enhance the efficiency of rail transport system, which shall result in economic growth in the region over time. Possible impacts on land are given below:

Sl. No.	Item	Impact	Impact (Reason)	Mitigation / Enhancement
1.	Change in geology	Direct, long term, negative impact	Extraction of material (borrow earth, coarse & fine aggregates)	Quarry redevelopment plan to be prepared. (If material is procured from a private quarry then Contractor is required to arrange and submit such a plan from the quarry owner.

Sl. No.	Item	Impact	Impact (Reason)	Mitigation / Enhancement
2.	Change in seismology	No negative impact	Natural process	Cross drainage structures shall be checked and complied with the seismological settings of the region as per the applicable Design codes.
3.	Change in land environment	Direct negative impact	May be due to construction activities	Preventive measures against pollution of land/ soil to be taken
a.	Generation of debris	Negative impact	May contaminate air, water and land, if not disposed properly	Disposed properly to avoid contamination
b.	Soil erosion	Moderate, direct, long term negative impact	<ul style="list-style-type: none"> • Slopes and spoils near the bridges • Construction of new bridges and culverts • quarry and borrow areas 	<ul style="list-style-type: none"> • Embankment protection • Residual spoil need to be disposed properly • silt fencing need to be provided, • quarries and borrow areas shall have necessary consents / approvals from authorities. All quarries and borrow areas closed after the project shall be reclaimed. In case of quarries not being operated by Contractor shall submit such approvals or consents from the quarry owner.
4.	Contamination of soil	Direct, long term negative impact	<ul style="list-style-type: none"> • Scarified bitumen wastes • Oil & diesel spills • Emulsion sprayer and lying of hot mix • Production of hot mix and rejected material 	<ul style="list-style-type: none"> • Hazardous Waste (Management, Handling and Trans-boundary) Rules, 2008 to be enforced. • Oil interceptor shall be provided for accidental spill of oil and diesel • Septic tank or suitable waste disposal facilities

Sl. No.	Item	Impact	Impact (Reason)	Mitigation / Enhancement
			<ul style="list-style-type: none"> Residential facilities for the labor and officers requiring routine and periodical maintenance 	shall be constructed for waste disposal
5.	Soil quality monitoring		<ul style="list-style-type: none"> Effectiveness / shortfall (if any) Any unforeseen impact 	Measures shall be reviewed & improved to mitigate / enhance environment due to any unforeseen impacts

11. BORROW AREA MANAGEMENT PLAN

- a. Borrow areas shall be identified and finalized by the Contractor in consultation with Engineer. Formal agreement between landowners and the Contractor has to be made. Suitability of borrow areas from civil Engineering as well as environmental consideration has to be ensured. Meeting the guidelines/notifications as stipulated from time to time by the Ministry of Environment and Forests, Government of India, and local bodies, as applicable shall be the sole responsibility of the Contractor.
- b. Besides this, precautions are to be taken by the Contractor for no unauthorized borrowing. No borrow area shall be opened without permission of the Engineer. Engineer in addition to the established practices, rules and regulation shall also consider under-mentioned criteria before approving the Borrow areas.
- c. To avoid any embankment slippage, the borrow areas shall not be dug continuously and the size and shape of borrow pits shall be decided by the Engineer. Redevelopment of the borrow areas to mitigate the impacts shall be the responsibility of the Contractor. The Contractor shall evolve site-specific redevelopment plans for each borrows area location, which shall be implemented after the approval of the Engineer.
- d. To ensure that the spills, which might result from the transport of borrow and quarry material do not impact the settlements, it shall be ensured that the excavation and carrying of earth shall be done in a careful manner. The unpaved surfaces used for the haulage of borrow material shall be maintained properly. Borrowing of earth shall be carried out at locations recommended as follows:
- e. Non-Cultivable Lands: Borrowing of earth shall be carried out up to a depth of 2 m from the existing ground level.
- f. Borrowing of earth shall not be done continuously. Ridges of not less than 8m width shall be left at intervals not exceeding 300 m. Small drains shall be cut through the ridges, if necessary, to facilitate drainage. Borrow pits shall have slopes not steeper than 1 vertical in 4 horizontal.
- g. Productive Lands: Borrowing of earth shall be avoided on productive lands. However, in the event of borrowing from productive lands, under circumstances as

described above, topsoil shall be preserved in stockpiles. The conservation of topsoil shall be carried out as described in section of this Appendix. At such locations, the depth of borrow pits shall not exceed 45 cm and it may be dug out to a depth of not more than 30 cm after stripping the 15 cm top soil aside.

- h. Elevated Lands: At locations where private owners desire their fields to be leveled, the borrowing shall be done to a depth of not more than 2 m or up to the level of surrounding fields.
- i. Borrow pits along Roadside: Borrow pits shall be located 5m away from the toe of the embankment. Depth of the pit should be such that the bottom of the pit shall not fall within an imaginary line of slope 1 vertical to 4 horizontal projected from the edge of the final section of the bank. Borrow pits should not be dug continuously. Ridges of not less than 8 m width should be left at intervals not exceeding 300 m. Small drains should be cut through the ridges to facilitate drainage.
- j. Borrow pits on the riverside: The borrow pit should be located not less than 15m from the toe of the bank, distance depending on the magnitude and duration of flood to be withstood.
- k. Community / Private Ponds: Borrowing can be carried out at locations, where the private owners (or in some cases, the community) desire to develop lands (mostly low-lying areas) for pisciculture purposes and for use as fishponds.
- l. General: - Contractor shall ensure the following issues are covered to the satisfaction of Engineer.
 - i. Water pooling to be avoided/ managed so that no disease spread or mosquito breeding takes place due to water stagnation.
 - ii. Precautionary measures as the covering of vehicles may be taken to avoid spillage during transportation of borrow area.
 - iii. Haulage of material to embankments or other areas of fill shall proceed only when sufficient spreading and compaction facility is operating at the place of deposition, to minimize dust pollution.
 - iv. During rains appropriate measures to be taken to minimize soil erosion, silt fencing to be provided as directed by Engineer/ EO.
 - v. Burrow pit should have proper guard to prevent accidental falling of children or animals.
- m. The Contractor shall keep record of photographs of various stages i.e., before using material from the location (pre-project),for the period borrowing activities construction Phase) and after rehabilitation (post development), to ascertain the pre and post borrowing status of the area.
- n. An appropriate Borrow Area Management Plan shall be formulated to control the degradation of the surrounding landscape due to the excavation work. The national standard which applies to the manual borrowing of earth is detailed in IRC-10:1961.

12. MITIGATION MEASURES TO MINIMIZE SOIL EROSION DURING CONSTRUCTION

- (1) Suitable protection measures consisting of bio-Engineering techniques such as plantation of grass and shrubs, may be provided to control erosion. The measures shall be applied along the slopes at high embankment where bridges shall be constructed.
- (2) Borrow areas may be finalized in concern with ecological sensitivity of the area. Agriculture land may not be used as borrow areas. Priority may be given to degraded area for excavation of borrows material. Rehabilitation of borrow area may be taken under the project.
- (3) Construction work may be avoided during rainy season to evade erosion and spreading of loose material.
- (4) Top soil removed from agricultural land may be stored separately in bunded areas and utilized during plantation or refilling of excavated area.
- (5) Selection of borrow areas may be done considering the waste land available in the district. Agricultural areas may be not used as borrow areas.

13. GEO-TECHNICAL ISSUES

The Contractor shall submit within the EMP the expected construction impacts for all major facilities and sections of higher embankments and deeper excavations, including material used for the building of the formation prior to construction, these impacts should include:

- (1) Determination of formation material quality and placement impact;
- (2) Stability factors, including seismic migration;
- (3) Drainage facilities for groundwater dewatering;
- (4) Effects on the local communities and transportation networks from overland truck transport of fill and excavate to and from the specific borrow and fill sites.
- (5) Specific mitigation measures and maintenance-of-traffic plans to ensure minimal disruption on local traffic conditions and the environment.

14. MITIGATION MEASURES FOR AMBIENT AIR QUALITY

- (1) Pre-Construction / preparatory Phase: The dust generation due to pre-construction activities shall be temporary in nature and localized and shall be effectively countered by sprinkling of water wherever required.
- (2) Construction Phase: Contractor shall undertake following specific measures regarding this aspect:-
 - a. Locating plant at a significant distance from nearest human settlement in the predominant down wind direction.
 - b. Vehicles delivering fine material like soil and fine aggregates may be covered to reduce spills on existing roads.
 - c. Water shall be sprayed on earthworks, temporary haulage and diversions on a regular basis.

- d. Batch type hot mix plants fitted with the bag filter / cyclone and scrubber shall be installed for the reduction of the air pollution.
- e. Hot mix plant and crushers shall be located at least 1 km from habitations and in down wind direction.
- f. Pollution control systems like water sprinkling and dust extractors and cover on conveyors shall be installed for the crushers.
- g. All vehicles, equipment and machinery used for construction shall be regularly maintained to ensure that the emission levels conform to the SPCB/CPCB norms.
- h. Air pollution monitoring plan has been delineated for construction phase separately for checking the effectiveness of the mitigation measures shall be adopted during the construction phase of the Contract
- i. Air quality monitoring shall be conducted during construction period and CPCB standard should be followed. The location and frequency of air monitoring is covered in EA document referred.

15. MITIGATION MEASURES FOR WATER QUALITY

Due to the proposed project there shall be some direct and indirect long term impacts on the water resources during construction. Table below presents the major adverse impacts on the water resources and the mitigation measures taken. While planning for mitigation measures is the responsibility of the DFCCIL, the Contractor shall be responsible for execution of the same.

Sl. No.	Item	Impact	Impact (Reason)	Mitigation/Enhancement
1.	Loss of water bodies	Not significant as no major water bodies is fully affected	Part or acquisition of source of water	<ul style="list-style-type: none"> • Land will be acquired by DFCCIL for ROW • Relocation of surface water sources by DFCCIL
2.	Water requirement for construction work (to be organized by Contractor)	Direct impact	<ul style="list-style-type: none"> • Water requirement for construction activity. • Water requirement of labour 	Contractor needs to obtain approval for taking adequate quantities of water from surface and ground water sources from applicable competent authority.
3.	Water Quality			
a.	Increased sedimentation	Direct impact	<ul style="list-style-type: none"> • Increased sediment laden run-off alter the nature & capacity of the watercourse 	Guidelines for sediment control shall be followed
b.	Contamination of water	Direct adverse impact	<ul style="list-style-type: none"> • Scarified bitumen wastes • Oil & diesel spills 	<ul style="list-style-type: none"> • Hazardous Wastes (Management, Handling and Trans-boundary) Rules, 2008 to be enforced

Sl. No.	Item	Impact	Impact (Reason)	Mitigation/Enhancement
			<ul style="list-style-type: none"> Emulsion sprayer and laying of hot mix Production of hot mix and rejected material Residential facilities for the labour and officers Routine and periodical maintenance 	<ul style="list-style-type: none"> Oil interceptor shall be provided for accidental spill of oil and diesel by Engineer Septic tank or suitable disposal arrangements shall be provided for waste disposal
4.	Water quality monitoring	Data to be monitored w.r.t. statutory norms	<ul style="list-style-type: none"> Effectiveness / shortfall (if any) Any unforeseen impact 	Measures shall be reviewed & improved to mitigate / enhance environment due to any unforeseen impact

a. Water Quality Management

Contractor shall undertake following measures to avoid contamination of water bodies:-

- i. Construction work close to the streams or water bodies may be avoided during monsoon.
- ii. The discharge standards promulgated under the Environmental Protection Act, 1986 shall be strictly adhered to. All wastes arising from the project shall be disposed of in a manner that is as per the provisions of the State Pollution Control Board (SPCB).
- iii. Unless otherwise authorized by the local sanitary authority, arrangements for proper disposal of excreta by incineration at the workplace suitably approved by the local medical health or municipal authorities shall be made.
- iv. Water quality shall be monitored regularly near the construction site.

16. NOISE ENVIRONMENT – MITIGATION MEASURES

Following mitigation measures will be implemented by the Contractor.

Sl. No.	Item	Impact	Impact (Reason)	Mitigation / Enhancement

Sl. No.	Item	Impact	Impact (Reason)	Mitigation / Enhancement
1	Noise pollution (pre-construction)	Direct impact, short duration	<ul style="list-style-type: none"> Man, material and machinery movements Establishment of labor camps onsite offices, stock yards and construction plants 	<ul style="list-style-type: none"> Area specific and for short duration Machinery to be checked & complied with noise pollution regulations. Camps to be setup away from the settlements.
2	Noise Pollution (Construction Stage)	Marginal impact	<ul style="list-style-type: none"> Stone crushing, asphalt production plant and batching plants, diesel generators etc. Community residing near to the work zones 	<ul style="list-style-type: none"> Camps to be setup away from the settlements, in the down wind direction. Noise pollution regulation to be monitored and enforced. Temporary, as the work zone will be changing with completion of construction
3	Noise Pollution Monitoring (Construction stage)	Data to be monitored w.r.t. statutory norms	Effectiveness / shortfall (if any) Any unforeseen impact	Measures will be reviewed & improved to mitigate/ enhance environment due to any unforeseen impact.

17. MITIGATION MEASURES FOR NOISE DURING CONSTRUCTION PHASE

- (1) Noise standards shall be strictly enforced on all vehicles, plants, equipment, and construction machinery. All construction equipment used for an 8-hour shift shall conform to a standard of less than 90dB (A). If required, high noise producing generators such as concrete mixers, generators, graders, etc. shall be provided with noise shields/ mufflers.
- (2) Machinery and vehicles shall be maintained regularly, with particular attention to silencers and mufflers, to keep construction noise levels to minimum.
- (3) Workers in the vicinity of high noise levels shall be provided earplugs/ ear mufflers helmets and shall be engaged in diversified activities to prevent prolonged exposure to noise levels of more than 90dB(A) per 8 hour shift. CPCB standard is to be observed.
- (4) During construction vibratory compactors will be used with due care within the urban areas. In case of complaints from nearby residents, the Engineer shall ask the Contractor to take suitable steps of restricting the work hours even further or use an alternative roller.

- (5) Proposed tree and shrub plantations planned for avenue plantation especially close to settlements, may form an effective sound buffer during the operation stage.
- (6) People have to be convinced / educated to prevent sensitive land uses from developing up adjacent to the project corridors.

18. CONTROL REQUIREMENTS

Under the Contract, the Contractor shall:

- (1) Perform work within the procedures outlined herein and comply with applicable codes, regulations, and standards established by the Indian Government and their agencies.
- (2) Schedule and conduct operations in a manner that shall minimize, to the greatest extent feasible, the disturbance to the public in areas adjacent to the construction activities and to occupants of buildings in the vicinity of the construction activities.
- (3) Submit to the Engineer a Noise Monitoring and Control Plan (NMCP), within 4 months from Commencement Date, which shall form part of the overall EMP, including full and comprehensive details of all powered mechanical equipment, which he proposes to use during daytime and night-time and of his proposed working methods and noise level reduction measures.
- (4) The NMCP shall include detailed noise calculations to demonstrate the anticipated noise generation by the Contractor.
- (5) The NMCP prepared by the Contractor shall guide the implementation of construction activity.
- (6) The NMCP will be reviewed on a regular basis and updated as necessary to ensure that current construction activities are addressed.
- (7) It shall appear as a regular agenda item in project coordination meetings.

19. MITIGATION MEASURES FOR HYDROLOGICAL CONDITION (RIVERS AND LAKES)

Construction Phase

- a. To avoid any unwanted accumulation of water/ water logging, provision of temporary drainage arrangement due to construction activities shall be made by Contractor.
- b. Silt fencing may be provided near water bodies.
- c. Proper drainage may be planned in the area to avoid water logging.

20. MITIGATION MEASURES FOR FLORA DURING CONSTRUCTION

- (1) Land free from encumbrances including trees and structures shall be provided to the contractor by DFCCIL. Cutting / removal of trees shall be done by CST contractor and permission/NOC shall be the responsibility of DFCCIL. For

temporary land / site hired/ acquired by the Contractor cutting of trees will be the responsibility of the Contractor.

- (2) Trees falling outside the RoW shall not be felled.
- (3) Labour camps and office site shall be located outside and away from the forest area.

21. MITIGATION MEASURES FOR FAUNA DURING CONSTRUCTION

- (1) Borrow areas can be also developed as ponds with grasses and shrubs planted around it.
- (2) Silt fencing may be used near water bodies to avoid runoff into the water bodies.
- (3) Construction activity may be avoided during night hours in forest area.
- (4) Poaching must be strictly banned in the forest area. It may be ensured by the Contractor that no hunting or fishing is practiced at the site by any of the worker and that all site personnel are aware of the location, value and sensitivity of the wildlife resources. The Wildlife (Protection) Act, 1972 will be applicable.
- (5) Awareness program on Environment and Wildlife Conservation may be provided to the work force. Forest Act and Wildlife Act may be strictly adhered to.

22. LANDSCAPE

Construction Phase

Landscaping plan may be formulated for restoration, leveling and landscaping of the area once construction activities are over. This can involve the following:-

- (1) The stockpiles may be designed such that the slope does not exceed 1:2 (vertical to horizontal) and the height of the pile to be restricted to 2 m.
- (2) Stockpiled topsoil may be used to cover the disturbed areas and cut slopes. The top soil shall be utilized for redevelopment of borrow areas, landscaping along slopes, incidental spaces etc.
- (3) Incorporation of suitable and effective contractual clauses for rehabilitation and restoration of borrow areas and other temporary works and landscaping it with surrounding area immediately after its use shall be made by the Contractor with its Sub Contractor for earthworks.

23. VIBRATION LEVEL LIMIT

- (1) The vibration level limits adjacent to the alignment shall conform to appropriate legislation of Government of India in this regard. In absence of any Indian standard, relevant international standards may be referred.
- (2) The scheme for monitoring the vibration level at the site shall be submitted to Engineer for his approval.
- (3) The scheme shall include:
 - a. monitoring requirements for vibrations at regular intervals throughout the construction period;

- b. pre-construction structural integrity inspections of historic and sensitive structures close to project activity is to be conducted by the Contractor in consultation with Engineer;
- c. Information dissemination about the construction method, probable effects, quality control measures and precautions to be used.

24. ARCHAEOLOGICAL STRUCTURE

Any structure/ article of archaeological importance found during construction stage along the alignment, shall be dealt as per the Act and procedure detailed in Environmental Management Framework.

25. PUBLIC HEALTH AND SAFETY

The Contractor is required to comply with all the precautions required for the safety of the workmen. The Contractor must comply with all regulation regarding scaffolding, ladders, working platform, excavation, etc. as per SHE manual of DFCCIL. Silica Exposure Reduction Strategies to be implemented by the Contractor during construction is given at Annexure-I attached with this Appendix.

26. GREEN BELT

Green belt as and if required shall be developed by CST contractor within the land acquired by the DFCCIL for the project. Hence, development of green belt is not included in the scope of System Contract. System contractor shall ensure not to damage any green belt. In case of any damage to the green belt during course of work, the contractor shall make good the damage in consultation with the Engineer.

27. WASTE

A. Control of waste generation during construction and its safe disposal is the responsibility of the Contractor.

- (1) Principle of 3R's (Reduce, Reuse, Recycle) shall be followed while handling waste from the construction Site. The Contractor is required to develop, institute and maintain a Waste Management Program (WMP) during the construction of the project for his works, which may include:-
 - a. Identification of disposal sites.
 - b. Identification of quantities to be excavated and disposed of.
 - c. Identification of split between waste and inert material
 - d. Identification of amounts intended to be stored temporarily on site location of such storage.
 - e. Identification of intended transport means and route.
 - f. Obtaining permission, wherever required, for disposal.
- (2) A mechanism shall be developed to ensure that the pre-designated area is available for the segregation and temporary storage of reusable and

recyclable material. This shall be incorporated in the WMP. The WMP should be prepared and submitted to the Engineer for approval.

- (3) The Contractor shall handle waste in a manner that ensures that wastes are held securely, maintained and waste storage area is cleaned regularly.
- (4) The Contractor shall remove waste at regular interval and dispose at landfill sites, if available nearby, after obtaining approval/ consent of concerned authority. If such authority or landfill site is not available nearby, the wastes may be dumped at a pre-designated site within Project area in consultation with SPCB & Engineer.
- (5) Burning of wastes is prohibited. The Contractor shall not burn debris or vegetation or construction waste on the site but remove as per relevant Rules.
- (6) The Contractor shall make arrangements to disposal off metal scrap and other wastes which can be sold to authorized dealer(s) and maintain record of such sale for inspection by the Engineer.

B. Hazardous Waste Management (By Contractor)

- (1) Any waste classified as hazardous under the "Hazardous Wastes (Management, Handling and Trans boundary) Rules, 2008, shall be disposed according to the concerned Rules.
- (2) Chemicals classified as hazardous chemicals under "Manufacture, Storage and Import of Hazardous Chemical Rules, 1989 shall be stored in compliance with the said Rules.
- (3) The Contractor shall identify the nature and quantity of hazardous waste generated as a result of his activities and shall file a "Request for Authorization" to SPCB along with a map showing the location of storage area.
- (4) Outside the storage area, the Contractor shall place a display board clearly mentioning 'Hazardous Wastes' and quantity and nature of wastes, on date. Hazardous Waste needs to be stored in secured manner.
- (5) It shall be the responsibility of the Contractor to ensure that hazardous wastes are stored, based on the composition, in a manner suitable for handling, storage and transport. The labeling and packaging is required to be easily visible and be able to withstand physical conditions and climatic factors.
- (6) The Contractor shall approach only registered & authorized Recyclers of Hazardous Waste for direct sale/ disposal of Hazardous Waste, under intimation to SPCB.

28. ELECTROMAGNETIC COMPATIBILITY

- (1) The Contractor shall be responsible for the detailed co-ordination of his Design and construction activities and shall take lead in the management of Electromagnetic Compatibility (EMC) concern to his Works.

- (2) The Contractor shall be responsible for protection from electromagnetic interference. Contractor's EMC responsibilities shall include but not be limited to the following:
- a. Provision of all information reasonably required by the interfacing with Parties in timely and professional manner at all times.
 - b. The Contractor shall co-ordinate with the Engineer on all matters concerning EMC relating to works that may affect the IR operation of the existing route and pay special attention to the EMC protection of international, national, regional, private and IR telecommunication, radio and TV nets where such work shall be carried out in accordance with IR rules and regulations.

29. ENVIRONMENTAL MANAGEMENT PLAN & RESPONSIBILITIES

Table below presents summary of Environmental Management Plan (EMP) with the objective to minimize adverse environmental impacts during pre and during construction activities. The table covers possible environmental issues involved in the project and the corresponding necessary mitigation measures. Taking appropriate mitigation measures for the construction phase shall be the responsibility of the Contractor, and of the construction projects' Environmental Engineer who shall supervise the implementation of the EMP.

The Contractor shall implement EMP during pre and during construction phases while mitigation measures during the operation phase shall be implemented by the DFCCIL. The details of Environmental Management Program and Environmental Management Unit (EMU) are discussed in the subsequent paragraphs.

S. No.	Environmental Issue	Action to be Taken	Implementati on By	Supervision By
Pre-construction phase				
1.	Removal of Trees	Trees are likely to be felled in the Temporary land acquired by the contractor for labour camp etc. after obtaining permission from the concerned authorities.	System Contractor	DFCCIL through Engineer or other nominated agencies.
Construction Phase				
1.	Soil	Suitable protection measures to be provided to control erosion. Borrow areas to be finalized as per instruction of Engineer. Agriculture land shall be avoided as a borrow area. Priority may be given to degraded area for excavation of borrow material. Rehabilitation of borrow area to be taken up. Construction work may be avoided during rainy season to avoid erosion and spreading of loose material.	System Contractor	DFCCIL through Engineer or other nominated agencies

S. No.	Environmental Issue	Action to be Taken	Implementation By	Supervision By
		Top soil removed from agricultural land shall be stored separately in protected area for utilization during plantation or refilling of excavated area.		
2.	Water Bodies	Provision of temporary drainage arrangement due to construction activities may be made by Contractor. Silt fencing may be provided near water bodies. Proper drainage may be planned in the area to avoid water logging.	System Contractor	DFCCIL through Engineer or other nominated agencies
3.	Flora	Felling of trees for temporary land acquired by the contractor to be undertaken in coordination with Engineer and after obtaining permission of Forest dept. Trees outside the ROW shall not be felled. Labour Camps and office site shall be located outside & away from Forest area.	System Contractor	DFCCIL through Engineer or other nominated agencies
4.	Fauna	Ponds may be developed inside forest areas as the birds prefer water bodies. Borrow areas may be considered for the purpose. Silt fencing may be used near water bodies to avoid runoff into the water bodies. Construction activity may be avoided during night hours in forest area. Poaching is strictly banned in the Forest area as per relevant Act. The Contractor and its personnel shall be follow the same.	System Contractor	DFCCIL through Engineer or other nominated agencies
5.	Chance find :Archaeological structure/ article	All structures/articles found during construction stage along the alignment, shall be dealt as per relevant Act and procedures. The contractor shall obtain No Objection Certificate from ASI observing the following : 1. Necessary arrangements will be made to install appropriate equipment at the protected	System Contractor	DFCCIL through Engineer or other nominated agencies

S. No.	Environmental Issue	Action to be Taken	Implementation By	Supervision By
		<p>monument to monitor whether there is any structural threat on account of the railway operations.</p> <p>2. Necessary measures may be put in place for proper drainage along the raised embankment which will have the railway track.</p> <p>3. Cultural sign boards may be placed near the protected monuments to highlight its importance etc.</p>		
Pollution monitoring				
1.	Air	<p>Adequate dust suppression measures to be undertaken to control fugitive dust.</p> <p>Plantation activity to be undertaken at the construction sites. Workers to be provided with mask to prevent breathing problems while working with dust generating machine/ earth excavation / filling process.</p> <p>Trucks carrying soil, sand and stone may be covered to avoid spilling.</p> <p>Low emission construction equipment, vehicles and generator sets shall be used</p> <p>Plants, machinery and equipment should be handled in a manner to minimize dust generation.</p> <p>All crushers used in construction shall confirm to relevant standards.</p> <p>Air quality monitoring to be conducted at construction sites periodically.</p>	System Contractor	DFCCIL through Engineer or other nominated agencies / SPCB
2.	Water	<p>Silt fencing shall provide near water bodies to avoid spillage of construction material.</p> <p>Discharge of waste from construction / labour camp into water bodies without treatment is strictly prohibited.</p> <p>Construction methodologies with minimum or no impact on water quality to be adopted.</p>	System Contractor	DFCCIL through Engineer or other nominated agencies / SPCB

S. No.	Environmental Issue	Action to be Taken	Implementation By	Supervision By
		Construction debris /wastes to be disposed at designated sites		
3.	Soil	Asphalt emulsifier shall be handled with caution and any leakage detected shall be immediately rectified. Construction work may be avoided during rainy season to avoid erosion and spreading of loose material.	System Contractor	DFCCIL through Engineer or other nominated agencies
4.	Solid Waste	Construction work shall be carried in such a way that minimum or no solid waste is generated at construction site. Extra earth material produced may be utilized for refilling of borrow areas. Rainy season may be avoided to minimize spreading of loose material. Solid waste management plan may be framed for implementation in camp areas. Dustbins to be provided in the Camps. Proper sanitation facilities must be provided in Camp by the Contractor.	System Contractor	DFCCIL through Engineer or other nominated agencies / SPCB
5.	Noise & Vibration	Noise from construction machines to be minimized by selection of right machine and noise suppressor wherever possible. Construction equipment's and vehicles shall be in good working condition, properly lubricated and maintained to keep noise within permissible limits. Temporary noise barriers to be installed at settlements and forest area, if required Plantation may be carried at the work site. Head phones, ear plugs to be provided to the workers working with high noise generating equipment at construction site. Noise level monitoring shall be conducted during construction phase.	System Contractor	DFCCIL through Engineer or other nominated agencies / SPCB

S. No.	Environmental Issue	Action to be Taken	Implementati on By	Supervision By
		All vehicles, equipment and machinery used in construction shall be fitted with exhaust silencers.		
6.	Land Subsidence	Plantation shall be done to control erosion at specific areas.	System Contractor	DFCCIL through Engineer or other nominated agencies
7.	Bottom Sediment	Silt fencing may be provided to avoid runoff into the river. Construction activity may be taken in dry season to avoid spreading of construction material and minimize impact on water quality	System Contractor	DFCCIL through Engineer or other nominated agencies

30. ENVIRONMENTAL MONITORING

The environmental monitoring shall be undertaken during construction and operation phases as per the details given the Table below. The contractor shall **survey, assess the requirements and comply the regulations/ standards**. While the Contractor will be responsible for monitoring of environmental components during construction and necessary mitigation measures, DFCCIL will be responsible during operation phase.

Construction Phase

S. No.	Environmental Component	Parameter	Standards	Location	Frequency	Implementation by	Supervision
1	Air Quality	SPM, RPM, CO, NOx, Sox	CPCB standards	Stretch of the Project in progress near settlements and junctions stations.	3 times in a year (once in every season except monsoon)	System Contractor	DFCCIL through Engineer or other nominated agencies
2	Water Quality	As per IS:10500 standards	CPCB standards	Near water bodies and construction camps along the Project.	Once in three months during construction period, excluding monsoon		
3	Noise	Noise level on dB (A) scale	CPCB standards	Junction & stations and settlements along the Project.	4 times in a year (once in every season)		
4	Soil Quality	NPK, Sodium Absorption Ratio, Oil & Grease	CPCB Standards	Junction & stations and settlements along the Project.	Once in a year		

Annexure – I

SILICA EXPOSURE REDUCTION STRATEGIES (BY CONTRACTOR DURING CONSTRUCTION)

A. GENERAL APPLICATION

i. Description

- a) This addendum specifies minimum environmental health and safety equipment, practices and procedures to minimize exposures to airborne silica dust during quarry operations, stone crushing, transport, and site construction. The scope of this section is limited to dust controls and employee protection in these environments.
- b) This addendum shall take precedence over overlapping requirements in the Technical Specifications unless otherwise stated.
- c) This document is an integral part of the contract and the contractor has the responsibility to fully implement it. Any request to deviate from any specified requirement shall be made in writing to the project sponsor.
- d) This addendum supplements all local, regional and national laws and regulations concerning the location, environmental emissions, and occupational safety in these operations. If regulatory requirements are more stringent, or require more frequent verification than outlined in this standard, then the regulatory provisions shall take precedence and become the de facto requirement in that jurisdiction.
- e) Contractor(s) shall provide a copy of the licensing documentation (NOC/ Consent to Establish) for each facility from where they purchase crushed stone including each quarry, stone crusher mill, and hot mix plant indicating they meet all applicable requirements.

ii. General Site Requirements Quarries

- a) Operator must establish a reliable source of water with adequate capacity and pressure to run all dust suppression systems at the quarry site;
- b) Operator must establish a reliable source of power for all mechanical equipment at the stone quarry site;
- c) Residential areas and temporary employee housing must be located a minimum of 100 meters from any quarrying operations;
- d) Stone drilling, cutting and conveying operations shall be equipped with either continuous wet suppression system or dry dust collectors designed and operated per minimum requirements below.
- e) Dust controls in quarries must include water fed compressed air drilling equipment, enclosed screens; enclosed transfer points, covered conveyors, and chutes.
- f) Wet the surface of rock material with a hose before blasting operations.

iii. General Site Requirements Stone Crusher Mills and Hot Mix Plants

- a) Contractor shall submit a detailed plan for any temporary stone crusher or hot mix plant sites intended to be utilized for this project. The plan shall show adjacent areas within 100 meters and depict all structures and roadways. All temporary sites must meet all requirements specified in this addendum and must obtain a Consent to Establish/ (NOC) from the applicable authorities.
- b) Temporary or permanent stone crusher sites or hot mix plants must meet all of the following requirements:
 - (i) Site must be at least 250 meters from National and State Highways and 500 meters from schools, educational institutions and religious places.
 - (ii) Establish green belt zone as required by applicable local requirements;
 - (iii) Residential areas and temporary employee housing must be located a minimum of 200 meters from any stone crushing equipment or operations;
 - (iv) Operator must establish a reliable source of water with adequate capacity and pressure to run all dust suppression systems installed at the stone crusher site;
 - (v) Operator must establish a reliable source of electricity for powering all mechanical equipment and pollution controls installed at the stone crusher site;
 - (vi) Crushing, screening, and conveying operations shall be equipped with either continuous wet suppression system or dry dust collectors designed and operated per minimum requirements below.
 - (vii) Crushing, screening, and conveying operations must be enclosed with sheet metal or other rigid material. Do not use cloth or plastic enclosures.
 - (viii) Roadways inside the crusher mill shall be metalled, paved or otherwise treated with chemical suppressants for dust suppression.
 - (ix) Waste dust material from stone crushing operations shall be stored in closed containers or closed structures.
 - (x) Lorries exiting the site must be cleaned with shovel and broom to minimize dust being tracked off site.
 - (xi) Minimize drop heights to storage piles;
 - (xii) Windbreak walls that are at least six times longer than its height shall be in place.
 - (xiii) Regularly remove and safely dispose of waste material (rock dust) from the plant site in covered lorries;
 - (xiv) Fugitive emissions including emissions from stockpiles, conveyors and other areas shall be minimized as far as practicable. Emissions from these sources shall be substantially free from visible dust

emission.

B. GENERAL SITE REQUIREMENTS CONSTRUCTION SITES

The following requirements shall be implemented during the following operations:

- i. Stockpiling;
- ii. Earth moving/ earth works, grading, and leveling;
- iii. Transfer from stock pile to work site;
- iv. Final placement; and
- v. Laying the track.
 - a) Operator must establish a reliable source of water with adequate capacity and for all dust suppression required at the construction site;
 - b) Regularly remove and safely disposing of waste material (rock dust) from the site in covered lorries;
 - c) Waste dust material from stone crushing operations if used for fill shall be covered within 4 hours;
 - d) Minimize spillage of raw material. Promptly clean up all spillage and accumulations of dust.
 - e) Fugitive emissions including emissions from stockpiles and other areas shall be minimized as far as practicable. Emissions from these sources shall be substantially free from visible dust emission.

1 General Environmental Protection:

The Contractor shall take steps to protect the environment and surrounding populations from silica dust hazards. Ensure that the water required for dust suppression operations is sourced from a supply that will not impact the quality or availability of water in the surrounding environment. Follow all State requirements for siting criteria and obtain consent from applicable state pollution control board. Ensure that emissions, surface discharges and site closure practices shall comply with all applicable laws including but not limited to:

- a) The water (prevention and control of pollution) act 1974; no. 6 of 1974.
- b) The air (prevention and control of pollution) act, 1981; no. 14 of 1981.

2 Technical Requirements to Minimize Airborne Dust Emissions

i. General

The handling of raw material, products, wastes or by-products should be carried out as to minimize the release of airborne dust. Use Table below for guidance in employing dust suppression methods.

Feasible Control Measures for Open Dust Sources: Fugitive Emission Control Measure

Source	Enclosures	Wet Suppression	Chemical Stabilization	Green Belt	Surface Cleaning	Wind Break Walls
Unpaved roadways and staging areas		X	X			
Storage piles	X	X	X			X

Source	Enclosures	Wet Suppression	Chemical Stabilization	Green Belt	Surface Cleaning	Wind Break Walls
Stone crushing operations	X	X		X	X	X
Paved roadways and staging areas					X	
Exposed areas	X	X	X	X		X
Batch drop operations	X	X				X
Continuous drop operations	X	X				X

ii. Wet Methods: Water spray Dust Suppression Systems for Stone Crushing Mills

Details of system components for all stone crusher facilities:

- (a) Minimum number and locations of pressure spray nozzles:
 - 1 nozzle on the top of the crusher
 - 2 nozzles at the delivery point of crushing material
 - 1 nozzle on the bottom of the vibrator screen or rotary screen
 - 2 nozzles within the storage hopper
 - 1 nozzle at the delivery point of raw material
 - 1 nozzle at the bottom of the dust hopper
- (b) A water pump with adequate motor horsepower and discharge pressure as required for optimal performance of spray nozzles.
- (c) Covered water storage tank, with a manhole type maintenance provision. The cover should prevent atmospheric dust from entering the tank. The tank can be located at the ground level. Water from a bore well or other source could be pumped to fill the tank periodically.
- (d) Centrifugal mono block type self-priming pump capable of delivering 3 to 5 kg/cm² pressure and 72 liters per minute.
- (e) 100 stainless steel mesh online water filter with two parallel cells. Parallel cells should be set up in order for to allow connections to be reversed such that one cell undergoes backwash cleaning while the other cell is in operation. Only filtered water should be supplied to the spray nozzles.
- (f) Chemical surfactants or wetting agents may be added to water used in the spraying systems.
- (g) All spraying systems used for dust suppression shall be maintained in good condition. The flow rate and operating pressure of the spraying liquid/solution shall be sufficient to suppress dust emissions from the corresponding sources. The spraying system shall be able to cover the areas of emission points concerned.
- (h) All water spray equipment shall be operational during all stone

crushing operations at the site.

- (i) No domestic showers, sprinklers, or other general water spray devices may be substituted for pressure misting nozzles. Nozzles may be hollow cone, solid cone or fan type.

iii. Dry Methods: Dust Extraction Systems for Stone Crusher Mills/ Hot Mix Plants

Details of system components:

- (a) Minimum requirements for dry dust capture and collection systems:
 - Hood or enclosure to capture emissions;
 - Dust collector that separates particulates (e.g. centrifugal dust collectors); and
 - Duct to transport particulates in air stream from dust collector to air pollution control device (e.g. bag house).
- (b) Capture hoods shall be installed over all crusher units and screens. Enclosures shall surround all sources of dust to the extent possible.
- (c) Dust collector shall be connected in-line via an enclosed duct to a cyclone and bag house for dust removal.
- (d) Air handling system shall be a suitable size to prevent the escape of untreated airborne dust. Maintain minimum airflow as per design. A minimum draft velocity of 1 meter/ second shall be maintained through all open hoods.
- (e) Inspect bag filters routinely and at least once per month for damage and clean, repair or replace as needed.

iv. Dust Containment Enclosures for Stone Crusher Mills and Hot Mix Plants:

Particulate emissions shall be controlled by installing dust containment enclosures at the following locations:

(a) Primary crusher discharge area

Enclosure shall cover discharge areas to all conveyor belts or secondary crusher.

(b) Vibratory screen

All vibratory screens shall be totally enclosed. Screen houses shall be rigid and reasonably dust tight with self-closing doors or close-fitted entrances and exits for access. Where conveyors pass through the screen house, flexible covers should be installed at entries and exits of the conveyors to the housing.

(c) Conveyor belts (optional)

The enclosures should be complete from all the four sides and roof. There should not be any open windows/openings etc. Any opening should be kept closed during operation. The gaps should be sealed using gaskets or wool type packing etc. Crusher enclosures shall be rigid and be fitted with self-closing doors and close-fitting entrances

and exits. Where conveyors pass through the crusher enclosures, flexible covers should be installed at entries and exits of the conveyors to the enclosure.

(d) Inlet hopper

The inlet hopper shall be enclosed on three sides.

(e) Rotary dryer

The plant rotary dryer in a hot mix plant. Malfunctioning or breakdown of equipment leading to abnormal emissions shall be dealt with promptly. In any case, the abnormal emission due to equipment failure shall be stopped as soon as practicable. The dust collection system shall be routinely inspected and maintained in good condition and shall be used as required. The owner shall conduct an inspection of the dust control system at least once per month.

v. Minimize Fugitive Dust From Roadways and Stock Piles

Minimize fugitive dust emissions from all sites where crushed rock is stored. Particulate emissions from unpaved roads and stock piles shall be controlled with the application of suitable compounds to minimize the control of dust. Petroleum-based products, waste oils or other waste products shall never be used for this purpose. Acceptable compounds for this purpose include:

- a) Acrylic polymers;
- b) Solid recycled asphalt;
- c) Chloride compounds (calcium chloride and magnesium chloride);
- d) Lignin compounds (lignin sulfate and lignin sulfonate powders);
- e) Natural oil resins (soybean oil); and
- f) Organic resin emulsions.

Contractor shall provide a product information sheet prepared by the manufacturer or distributor indicating the chemical composition, application instructions, and other environmental, safety and health considerations 30 days in advance of its intended application to Engineer's Representative. The product information shall be reviewed and approved in writing before the contractor proceeds to apply it on the project site.

vi. Minimize Fugitive Dust From Heavy Equipment and Road Transport Vehicles

Minimize fugitive dust emissions from all vehicles when loading, unloading and operating vehicles on project sites, staging areas, or stone crusher mills. Settled dust and particulate emissions from lorries used to transport stone or waste products generated in stone crushing operations, and other heavy construction vehicles, shall be minimized in accordance with the following practices:

Lorries shall be filled with the material using wet methods. Load waste fine material and powders onto tankers or closed trucks through a lengthy sleeve attached to the spout to minimize drop height and dust release.

Lorries once filled with stone or other waste material shall be covered before leaving the site. A single layer impermeable tarp shall be placed over the entire load and secured with rope or other tension bar.

Designate a decontamination area that is required to be used by all vehicles before exiting the site. This area shall be covered with an impervious tarp. Use wet methods to wipe all accessible exterior surfaces of vehicles and tires.

Impose strict speed limits for all vehicles operating on service roads, loading areas, or staging areas.

Minimize Fugitive Dust During Rock Quarry Operations

Particulate emissions shall be controlled during drilling, blasting, loading, and hauling with wet methods using surfactants applied in either water or foam spray.

Dust controls for stone drilling shall use water fed into the compressed air to suppress the dust.

vii. **Work Practices for Reducing Employee Exposures**

This section pertains to all activities with potential for dust exposure to workers employed in quarries, stone crusher units, hot mix plants, and construction sites.

Use wet methods where feasible to reduce dust emissions from working surface or equipment.

Use a gentle spray or mist to moisten settled dust particles. When washing large quantities of dust from a surface, increase the water force only after pre-wetting all the dust with a gentle spray. Use only the minimum amount of water needed to get the job done without creating runoff.

Rewet surfaces as necessary to control dust.

C. TECHNICAL REQUIREMENTS FOR WORKER MEDICAL SURVEILLANCE

i. General

This section pertains to workers employed in quarries, stone crusher units, and hot mix plants.

ii. Medical Monitoring

Medical monitoring shall be conducted for each worker before the start of work and at least at annually thereafter. Examination shall as a minimum meet requirements as set forth below:

Examination

- a) The employer of the worker shall ensure that all medical examinations and procedures are performed by a licensed physician, and are provided at no cost to the employee and at a reasonable time and place.
- b) Persons employed under the licensed physicians may administer the pulmonary function testing, chest x-ray or other testing procedures required

by this section if adequately trained by an appropriate academic or professional institution.

- c) A physical examination directed to the pulmonary system, including a chest x-ray to be administered and pulmonary function tests of forced vital capacity (FVC) and forced expiratory volume at one second (FEV(1)). Interpretation and classification of chest roentgenograms shall be conducted in accordance with ILO classification system. Interpretation of the chest x-ray shall be conducted under the ILO Classification of Radiographs of Pneumoconiosis by a reader trained under this protocol. Evaluate chest x-ray for possible tuberculosis because people exposed to silica have increased susceptibility.

Report from Medical Examination: A report must be submitted from all medical examinations conducted within the last 12 months to document compliance with this medical surveillance requirement for each worker employed in quarries and stone crusher units. Submit, at a minimum, for each worker the following:

Name and Employee Identification Number

Physician's Written Opinion from examining physician including at a minimum the following:

- 1) Whether worker has any detected medical conditions that would place the worker at an increased risk of material health impairment from exposure to silica.
- 2) A statement that the worker may wear a negative pressure respirator or any recommended limitations on the worker or on the use of personal protective equipment such as respirators.
- 3) Statement that the worker has been informed by the physician of the results of the medical examination and of any medical conditions that may result from dust exposure.

iii. Record Keeping

- a) The employer shall establish and maintain accurate records of medical surveillance to include the physician's written opinion on each employee's health status.
- b) Records shall be maintained for at least the duration of the contract period.
- c) A copy of the each employee's records must be provided to the affected employee who has undergone the medical surveillance stipulated above within 30 days of the date of the examination.

D. REQUIREMENTS FOR EMPLOYEE TRAINING

i. General

- a) This section pertains to all workers employed in quarries, stone crusher units, hot mix plants, and any construction workers using powered tools or equipment to cut, grind, core, or drill concrete or masonry material. The training provided under this section shall be provided to workers at no cost to these employees and in a language understood by workers at each

training program. The course shall be taught by an environmental health and safety specialist with adequate education, experience and training.

- b) Incorporate general information about silica dust hazards in all orientation and site training sessions covering health or safety aspects.

ii. Training Topics

The employer shall provide training on the following topics to all employees prior to their assignment to jobs where the employer will be conducting these operations during this project:

- a) The potential health hazards of exposure to airborne silica dust including silicosis, tuberculosis, lung cancer, chronic obstructive lung disease (COPD) and decreased lung function.
- b) Methods used by the employer to control employee exposures to airborne silica dust including wet or dry methods for stone crushing, drilling, cutting, local exhaust ventilation systems, and isolation of the process from employees by means of distance, enclosure, or other means, as applicable.
- c) Proper use and maintenance of dust reduction systems, including the safe handling and disposal of waste material.
- d) The importance of good personal hygiene and housekeeping practices when working in proximity to silica dust including:
 - Not smoking tobacco products; appropriate methods of cleaning up before eating, and appropriate methods of cleaning clothes.
 - Avoiding, to the extent practical, activities that would contribute significantly to exposure to airborne dusts.

E. WORKER PROTECTION

i. General

Contractors shall supply respirators and other specified safety equipment to all workers employed in quarries, stone crusher units, hot mix plants, and any construction workers using powered tools or equipment to cut, grind, core, or drill concrete or masonry material as described below:

- a. Do not eat, drink, smoke, chew or smoke tobacco in the work area. To eat, drink, chew, or smoke, workers shall follow the procedures described below and leave the work area.
- b. Provide workers with a clean source of water for a facility to wash hands and face with soap and water. This should be done before eating, smoking or drinking and at the end of the day before going home. Hand washing facilities shall be set up adjacent to the work area.
- c. Engineering and work practice controls must be used whenever the possibility exists that employee may be exposed to silica including during stone crushing and construction operations.
- d. The use of compressed air, dry sweeping, or any cleaning method that would cause elevated silica dust air concentrations are prohibited.

ii. **Respiratory Protection**

Minimum Respiratory Protection: Require that the minimum level of respiratory protection used be Respirator Class FFP3 under European standard EN 143 or N99 under the U.S. National Institute for Occupational Safety and Health (NIOSH) classification. Respirators shall be single use disposal respirators for dusts or reusable half-face air-purifying respirators with high efficiency particulate air filters.

Require that a respirator be worn by anyone in a Work Area at all times during any operation. Do not allow the use of surgical masks or other types of disposable respirators not specified above for any purpose.

Fit testing shall be conducted on any reusable air-purifying respirator assigned to the worker.

Only assign respirators to workers medically approved to wear negative pressure respirators as per the physicians' written opinion following an annual medical examination as per the requirements in Part 3 of this addendum.

iii. **Protective Equipment**

Do not allow workers to leave the work place wearing any clothing or equipment worn during the work shift. Provide the following:

- a) **Eye Protection:** Provide eye protection as needed for the type of work being performed.
- b) **Shoes:** Provide shoes to all workers and require that they be worn at all times in the Work Area.
- c) **Hearing protection:** Provide all workers at all quarries, stone crushing sites, and hot mix plants and all other workers exposed to loud noise with ear plugs or other suitable hearing protection.

F. EMISSION AND AMBIENT AIR LIMITS

i. General

Contractors shall conduct all required emissions monitoring as required to prove compliance with all applicable State Pollution Control Board Regulations and the limits specified within this section. This section applies to all permanent and temporary stone crushing mills and hot mix plants.

ii. Suspended Particulate Matter (SPM)

The Suspended Particulate Matter (SPM) at a distance of 40 meters from a stone crusher unit in a cluster should be less than 600 micro gram per cubic metre (micro-gm/Nm³).

The concentration of total particulate matter in any contained emissions to air, for example the bag filter exhaust air outlet, shall not exceed 150 ug per cubic metre (150ug/Nm³). The introduction of dilution air to achieve the emission concentration limits shall not be permitted.

Monitoring of the 24-hour average concentration of the total suspended particulate and/or respiratory suspended particulate in ambient air shall be conducted at the site boundary and/or any other locations to be agreed by the Authority. SPM sampling shall conform to the United State Environmental Protection Agency's

Reference Method for the Determination of Suspended Particulate Matter in the Atmosphere (High-volume Method) and shall be conducted at a frequency of not less than once every 6 months.

G. CHAIN-OF-CUSTODY FOR CRUSHED STONE

i. General

Contractor shall maintain records of suppliers for each load of crushed stone brought to the construction site with the procedures as outlined below. Such records shall be collected at a central location at least monthly during the duration of the project and be available for inspection by Engineer's Representative.

ii. Supplier Validation

Contractor shall maintain records of all suppliers and all internally sourced supplies of crushed stone brought to the construction site to include:

- a) Name of supplier;
- b) Location of stone crusher operation;
- c) Location and name of the quarry;
- d) Proof of registration and consent from the applicable Mining Department;
- e) Proof of registration and consent for operation from applicable Pollution Control Board;
- f) The supplied material size and quantity (by weight or volume);
- g) Date and specific location material was brought to site.

H. RESTORATION OF TEMPORARY STONE CRUSHER SITES

i. General

This section applies to the removal of any temporary stone crusher sites established and used during the duration of the project. During operation all temporary operations shall meet the requirements specified in Parts 1 and 2 above.

ii. Equipment removal

Temporary equipment shall be cleaned before being taken down and prepared for off-site transport. Clear off all temporary structures and garbage.

iii. Site restoration

Remove all debris and visible accumulations of dust from ground surfaces. Cover all bare soil surfaces with vegetation or pavement to reduce exposure to residual silica dust.

(End of Appendix-6)

APPENDIX-7: PMIS REQUIREMENTS AND PROCEDURES

1. GENERAL

- 1.1 Timely performance is of the essence on this project. The Contractor may complete the project or any part of the Project earlier than is stipulated in the Contract and the Milestone requirements.
- 1.2 The Contractor shall devise and utilize a Project Management Information System (PMIS) such that all documents generated by the Contractor can be transmitted to the Engineer by electronic means (and vice versa) and that all documents generated by either party are electronically captured at the point of origin and can be reproduced later, electronically and in hard copy. A similar link shall also be provided between the Engineer Office at site and the Employer's site office and Headquarter Office by the Contractor. The contractor shall develop his PMIS which will be compatible with the employer's existing PMIS and shall arrange for interfacing between the two.
- 1.3 All design and/or construction work, including all sub-contractors' work, under this Contract shall be planned, scheduled, executed, reported and accomplished using the precedence diagramming Critical Path Method (hereinafter referred to as CPM). The work required by this section includes the requirement to prepare, maintain, and update all detailed schedules as described in this section. The CPM schedules shall be prepared in such a manner as to permit the orderly planning, organization, and execution of the Work and be sufficiently detailed to accurately depict all the work required by the Contract. The Contractor shall resource (labor and equipment) and cost load its schedule as specified herein.
- 1.4 All schedules and schedule submittals under this Contract shall be computerized by the Contractor utilizing Professional Project Management Software, Oracle Primavera P6 or latest revision or any other software approved/instructed by Engineer capable of integrating with PMIS with the Engineer and the Employer.
- 1.5 The Contractor shall formally transmit all schedule submittals and schedule narratives identified herein to the Engineer in the form of six (6) hard copies and one (1) soft copy on a CD at the times identified herein or at the request of the Engineer.
- 1.6 The primary objectives of the requirements of this section are:
- 1) To insure adequate planning and execution of the Works by the Contractor;
 - 2) To assist the Engineer in evaluating progress of the Works;
 - 3) To provide for optimum coordination by the Contractor of its trades, Sub-contractors, and suppliers, and of its work with the Works or services provided by any separate contractors;
 - 4) To permit the timely prediction or detection of events or occurrences which may affect the timely execution of the Works;
 - 5) To establish a system to enable the Engineer to monitor the various activities carried out by the contractor to achieve the preset milestone to the timescale to meet the requirements of the contract document for completing the specified work in the contract.
- 1.7 The Contractor is responsible for determining the sequence of activities, the time estimates for the detailed design and construction activities and the means, methods,

techniques and procedures to be employed. The schedules identified herein shall represent the Contractor's best judgment of how it will execute the Work in compliance with the Contract requirements. The Contractor shall ensure that the schedule is current and accurate and is properly and timely monitored, updated and revised as project conditions may require and as required by the Contract documents.

- 1.8 The Contractor shall provide the basic data relating to activities, durations, specified Contract Milestones, and sequences to the Engineer, as part of Contractor required schedule submittals. This data shall reflect the Contractor's actual plan for the project, and shall fully comply with all requirements of the Contract documents.
- 1.9 Subject to the Engineer's agreement and unless identified elsewhere in the Contract documents, the Contractor shall determine when, where, and how it will interface with others performing work on the program and to coordinate its activities with all parties including the Employer and its consultants, suppliers and other contractors.
- 1.10 The Contractor shall include in the interim schedule and Contract baseline schedule all interface points with others. These points shall be in the form of start milestones for deliverables due to the Contractor from others and as Finish Milestones for deliverables that Contractor must supply to others.

2. SCHEDULER QUALIFICATIONS

The Contractor shall have within its employment or under contract, throughout the execution of the Work, such expertise in CPM scheduling and experience so as to ensure its effective and efficient performance under this Contract.

3. SCHEDULE ORIENTATION SESSION

- 3.1 The Contractor shall, upon notification from the Engineer, attend a schedule orientation session relating to the schedules and reports requirements for this Contract. The schedule orientation session is designed to review in detail, the objectives of the schedules and reports requirements and the contract requirements. The Contractor shall arrange for its Project Manager, superintendent, and scheduler to attend the schedule orientation session.
- 3.2 The following items shall be discussed during the schedule orientation session:
 - 1) The procedures and requirements for the preparation of the interim schedule, contract baseline schedule, and monthly updates by Contractor;
 - 2) How the requirements of the Contract documents will be monitored and enforced by the Engineer;
 - 3) Long-lead items and time requirements for the Work by sub-contractors will be identified and included in the contract baseline schedule;
 - 4) Work packages;
 - 5) Coding and logic for the contract baseline schedule; and
 - 6) Identification and scheduling of Shop Drawings and other submittals;
 - 7) Listing of major project milestones;
 - 8) Cost loading of major project summary activities.

4. INTERIM SCHEDULE

- 4.1 The Contractor shall submit its interim schedule, to the Engineer for review and acceptance at the Pre-Construction conference (or kick-off meeting for the Design portion of the project) indicating a detailed work plan for the first fifty six (56) days from the Commencement Date. Work beyond the first fifty six (56) days shall also be indicated in summary form.
- 4.2 The interim schedule detail plan shall include but not be limited to planned mobilization, sequence of early operations, submittals and procurement of materials and equipment. The interim schedule shall also include the following information as a minimum:
- 1) Activity identification number of the task or event;
 - 2) Description of the task or event;
 - 3) Duration of the task or event;
 - 4) Earliest start and finish dates for the task or event;
 - 5) Latest start and finish dates for the task or event;
 - 6) Various stages of Design development and Construction completion
 - 7) Milestones for activities given in this document and consequent critical points for interface with others.
 - 8) Logic links to previous tasks upon which the task is dependent before it can start and to subsequent tasks which are dependent on the task to be completed before they can commence
- 4.3 During the first fifty six (56) days following the Commencement Date, the interim schedule shall be updated regularly and submitted to the Engineer to indicate the progress of the Work, unless the contract baseline schedule is approved within fifty six (56) days of Commencement Date. Once the contract baseline schedule is accepted by the Engineer, no further updates of the interim schedule are required.

5. CONTRACT BASELINE SCHEDULE

- 5.1 Within forty-two (42) calendar days after the Commencement Date the Contractor shall complete the contract baseline schedule, which expands the accepted interim schedule, and submit it to the Engineer for review and acceptance. The contract baseline schedule submittal shall not show any progress until it is accepted by the Engineer.
- 5.2 The Contractor shall submit to the Engineer a complementary and detailed narrative description of its plan for performing the Work with the submittal of the contract baseline schedule. The narrative description shall summarize the overall approach to design and/or construction sequencing, including, but not be limited to:
- 1) The anticipated lost days due to weather;
 - 2) The equipment and personnel requirements by craft to complete a resource loaded schedule;
 - 3) Whether it proposes the Work be performed on single, double or triple shifts;
- 5.3 No application for payment shall be accepted until the contract baseline schedule is approved.

6. ACCEPTANCE OF THE INTERIM SCHEDULE AND CONTRACT BASELINE SCHEDULE

- 6.1 The Engineer and the Contractor shall review and discuss the interim schedule or contract baseline schedule after it has been submitted to the Engineer.
- 6.2 After the Engineer accepts the interim schedule and contract baseline schedule, these schedules will then be used to monitor and record progress of the Work, forecast completion dates, evaluate revisions and generate the payment application amounts, where applicable. Acceptance of the interim schedule or the contract baseline schedule by the Engineer shall not relieve the Contractor of total responsibility for the Contractor's means and methods, scheduling, sequencing, and prosecuting the Work to comply with the requirements of the Contract.
- 6.3 The Engineer shall have the right to require the Contractor to revise and resubmit the interim schedule and the contract baseline schedule to modify any Contractor data in the schedules or any portion of the schedules that the Engineer determines to be:
- 1) Impracticable;
 - 2) Based upon erroneous calculations or estimates;
 - 3) Unreasonable;
 - 4) Required in order to ensure proper coordination by the Contractor of the work of its Sub-contractors and with the work or services being provided by any separate contractors;
 - 5) Necessary to avoid undue interference with plant operations or those of any utility owners or adjoining property owners;
 - 6) Necessary to ensure completion of the Work by the Contract Milestones and Contract completion dates set forth in the Contract documents;
 - 7) Required in order for Contractor to comply with any other requirements of the Contract documents;
 - 8) Not in accordance with the Contractor's actual operations, unless the revision or modification will change the original scope of Works. The Contractor shall bear the expense of such revisions. If the Engineer requires such revisions, the Contractor shall revise the interim schedule or contract baseline schedule and submit it for Engineer's acceptance within seven (7) calendar days.
- 6.4 The Engineer reserves the right to require that the Contractor to adjust, add to, or clarify any portion of the schedules that may be determined to be insufficient for monitoring of the Work after the schedules are accepted. No additional compensation shall be provided for such adjustments, additions or clarifications.

7. SCHEDULE CONTENT AND FORMAT

- 7.1 All construction activity durations shall be given in working days. The Contractor shall develop activities for the schedules so that no single activity shown has duration longer than fourteen (14) working days, except for procurement and fabrication, delivery, submittal development and approval activities that may have longer durations.
- 7.2 For all equipment and materials to be fabricated or supplied for the Project, the contract baseline schedule shall show a sequence of activities including:

- 1) Material delivery and storage;
 - 2) Erection or installation;
 - 3) Testing of equipment and materials.
- 7.3 The interim schedule and contract baseline schedule shall show dependencies (or relationships) between each activity. Each activity must have a successor and predecessor, except for the project start and finish milestone. The use of date constraints shall be limited to Contract milestones and Contract completion dates only.
- 7.4 The interim schedule and contract baseline schedule shall contain or be able to demonstrate that the following items have been addressed:
- 1) The Project's name;
 - 2) The Contractor's name;
 - 3) Revision or edition number;
 - 4) Activities of completed work;
 - 5) Activities relating to different areas of responsibility, such as subcontracted Work which is distinctly separated from that being done by the Contractor directly;
 - 6) Labour resources distinguished by craft or crew requirements;
 - 7) Equipment and material resources distinguished by equipment and material requirements;
 - 8) Distinct and identifiable subdivisions of work such as structural slabs, beams, columns;
 - 9) Locations of work within the contract limit lines that necessitates different times or crews to perform;
 - 10) Outage schedules for existing utility services that will be interrupted during the performance of the Work;
 - 11) Acquisition and installation of equipment and materials supplied and/or installed by the owner or its separate contractors;
 - 12) Material to be stored on Site;
 - 13) Phases;
 - 14) Interim milestones and the Contract Completion dates.
- 7.5 The Contractor shall be responsible for expediting the delivery of all materials and equipment to be furnished by the Contractor so that the progress of construction shall be maintained according to the currently accepted contract baseline schedule for the Works. The Contractor shall notify the Engineer in writing, and in a timely manner, whenever the Contractor anticipates that the delivery date of any material or equipment will be later than the delivery date indicated by the currently accepted contract baseline schedule.

8. MONTHLY SCHEDULE UPDATE

- 8.1 An update of the accepted interim schedule or contract baseline schedule shall be submitted by the Contractor to the Engineer monthly and with the monthly application for payment. Receipt by the Engineer of the monthly schedule update will be an express condition precedent to processing each invoice.

- 8.2 On a monthly basis, the Contractor shall arrange for its Project Manager, superintendent, and scheduler to meet at the project Site with the Engineer to review Contractor's monthly schedule update. The schedule will be marked-up to show the agreed upon progress, signed by the Contractor, and a signed copy issued to the Project Manager. The monthly schedule update shall show up-to-date and accurate progress of the Works, and shall forecast the completion date for activities in progress based on the contract baseline schedule. The monthly schedule update shall be prepared by the Contractor in consultation with all its principal sub- contractors and suppliers.
- 8.3 The monthly schedule update shall include actual activity data for progress to date, but in the monthly schedule update, the Contractor shall not change the schedule logic, the activity relationships/dependencies, or planned activity durations and shall not add or delete activities. If the Contractor believes that any of these items should be changed, then a proposed revised baseline schedule must be submitted by the Contractor to the Engineer. Although activities shall not be added or deleted in the monthly schedule update, activities associated with Work authorizations that have been recommended for approval shall be included in the next monthly schedule update.
- 8.4 The Contractor will be notified by the Engineer, in writing, as to acceptance, reasons for rejection, or any revisions required to the schedules. Changes to the schedules agreed upon by the Contractor and the Engineer shall be incorporated by the Contractor into the schedules within seven (7) calendar days after agreement.
- 8.5 The monthly schedule update shall show actual activity commencement and completion dates, the actual remaining duration in workdays and physical percent complete for those activities commenced and not complete. For the stored materials, the update shall show the amount of material stored, representing the total cost of the materials delivered and properly stored. The monthly schedule update shall also show a graphic comparison of the current status and the baseline plan for each activity in the network.
- 8.6 Each monthly schedule update shall continue to show all work activities including those already completed. These completed activities shall accurately reflect "as built" information by indicating when activities were actually started and completed.
- 8.7 Monthly schedule updates shall also contain the following information for each activity:
- 1) Activity identification number, description and estimated original duration in workdays;
 - 2) Calculated early and late finish dates;
 - 3) Actual start and actual finish dates, and remaining duration, in calendar, for those activities started and not completed;
 - 4) Days ahead and/or behind schedule of the milestones representing the specified Contract Milestones and Contract completion dates;
 - 5) Physical percent complete for each activity;
 - 6) A float analysis of the longest path through the schedule detailing potential delays and areas for acceleration. Actual start and finish dates shall be indicated for each activity as appropriate. Completed activities will be omitted from remaining float and late start slots.

9. REVISED BASELINE SCHEDULE

- 9.1 If the current contract baseline schedule or monthly schedule update no longer

represents the actual or planned execution and progress of the Work, the Contractor shall submit a proposed revision to the current contract baseline schedule to the employer in accordance with the section at no additional cost. If the Engineer believes that the current contract baseline schedule or monthly schedule update no longer represents the actual or planned execution and progress of the Work, the Contractor shall submit, a proposed revision to the current contract baseline schedule to the employer in accordance with this section at no additional cost.

9.2 Schedule Revisions, as defined herein, shall refer to modifications made to activities in the accepted interim schedule or contract baseline schedule in any of the following items:

- 1) Activity duration;
- 2) Changes in logic connections between activities;
- 3) Changes in constraints;
- 4) Changes in value loading;
- 5) Changes to activity descriptions;
- 6) Activity additions and deletions.

9.3 Any proposed revisions to the contract baseline schedule must be submitted to the Engineer for acceptance. This submittal must include, at a minimum, a written narrative with a full description and reasons for each work activity revised a full schedule printout, and a soft copy of the proposed revised contract baseline schedule. For revisions affecting the sequence of work, the Contractor shall provide a schedule diagram Fragmented Network (Fragnet) which compares the original sequence to the revised sequence of work. This diagram shall maintain the Contract Milestone and Contract completion dates.

10. RECOVERY SCHEDULE

10.1 Should the updated interim schedule, contract baseline schedule or monthly schedule update, at any time during Contractor's performance, show that the Contractor is fourteen (14) or more calendar days behind schedule for any Contract interim Milestone, substantial completion or for Contract completion, the Contractor shall prepare a recovery schedule separate from the updated and approved monthly schedule update explaining and displaying how the Contractor intends to reschedule its work in order to regain compliance with the contract baseline schedule during the immediate subsequent pay period.

10.2 If a recovery schedule is required, the Contractor shall prepare and submit to the Engineer a recovery schedule, incorporating the best available information from sub-contractors and others, which will permit the forecasted completion dates to return to the interim milestones and the Contract completion dates. The Contractor shall prepare a recovery schedule to the same level of detail as the originally accepted contract baseline schedule submittal.

10.3 Within seven (7) working days after submission of the recovery schedule, the Contractor shall meet with the Engineer to review and evaluate the recovery schedule. Within seven (7) working days of that meeting, the Contractor shall submit the recovery schedule, including any revisions necessitated by the review, to the Engineer for its review and acceptance. The recovery schedule, once accepted by the Engineer, shall be

implemented as the revised contract baseline schedule for the remaining Work.

(End of Appendix-7)

APPENDIX-8: ENVIRONMENTAL, SOCIAL, HEALTH AND SAFETY (ESHS) METRICS FOR PROGRESS REPORTS

Metrics for regular reporting:

- a. environmental incidents or non-compliances with contract requirements, including air, noise, , water, soil quality monitoring, analysis and contamination, pollution or damage to ground or water supplies;
- b. health and safety incidents, accidents, injuries and all fatalities that require treatment;
- c. interactions with regulators: identify agency, dates, subjects, outcomes (report the negative if none);
- d. status of all permits and agreements:
 - i. work permits: number required, number received, actions taken for those not received;
 - ii. status of permits and consents:
 - list areas/facilities with permits required (quarries, asphalt & batch plants), dates of application, dates issued (actions to follow up if not issued), dates submitted to resident engineer (or equivalent), status of area (waiting for permits, working, abandoned without reclamation, decommissioning plan being implemented, etc.);
 - list areas with landowner agreements required (borrow and spoil areas, camp sites), dates of agreements, dates submitted to resident engineer (or equivalent);
 - identify major activities undertaken in each area this month and highlights of environmental and social protection (land clearing, boundary marking, topsoil salvage, traffic management, decommissioning planning, decommissioning implementation);
 - for quarries: status of relocation and compensation (completed, or details of monthly activities and current status).
- e. health and safety supervision:
 - i. safety officer: number days worked, number of full inspections & partial inspections, reports to construction/project management;
 - ii. number of workers, work hours, metric of PPE use (percentage of workers with full personal protection equipment (PPE), partial, etc.), worker violations observed (by type of violation, PPE or otherwise), warnings given, repeat warnings given, follow-up actions taken (if any);
- f. worker accommodations:
 - i. number of expats housed in accommodations, number of locals;
 - ii. date of last inspection, and highlights of inspection including status of accommodations' compliance with national and local law and good practice, including sanitation, space, etc.;
 - iii. actions taken to recommend/require improved conditions, or to improve conditions.
- g. HIV/AIDS: provider of health services, information and/or training, location of clinic, number of non-safety disease or illness treatments and diagnoses (no names to be provided);
- h. gender (for expats and locals separately): number of female workers, percentage of workforce, gender issues raised and dealt with (cross-reference grievances or other sections as needed);
- i. training:
 - i. number of new workers, number receiving induction training, dates of induction training;

- ii. number and dates of toolbox talks, number of workers receiving Occupational Health and Safety (OHS), environmental and social training;
 - iii. number and dates of HIV/AIDS sensitization training, no. workers receiving training (this month and in the past); same questions for gender sensitization, flaglady/flagman training.
- j. environmental and social supervision:
- i. environmentalist: days worked, areas inspected and numbers of inspections of each (road section, work camp, accommodations, quarries, borrow areas, spoil areas, swamps, forest crossings, etc.), highlights of activities/findings (including violations of environmental and/or social best practices, actions taken), reports to environmental and/or social specialist/construction/site management;
 - ii. sociologist: days worked, number of partial and full site inspections (by area: road section, work camp, accommodations, quarries, borrow areas, spoil areas, clinic, HIV/AIDS center, community centers, etc.), highlights of activities (including violations of environmental and/or social requirements observed, actions taken), reports to environmental and/or social specialist/construction/site management; and
 - iii. community liaison person(s): days worked (hours community center open), number of people met, highlights of activities (issues raised, etc.), reports to environmental and/or social specialist /construction/site management.
- k. Grievances: list this month's and unresolved past grievances by date received, complainant, how received, to whom referred to for action, resolution and date (if completed), data resolution reported to complainant, any required follow-up(Cross-reference other sections as needed):
- i. Worker grievances;
 - ii. Community grievances
- l. Traffic and vehicles/equipment:
- i. traffic accidents involving project vehicles & equipment: provide date, location, damage, cause, follow-up;
 - ii. accidents involving non-project vehicles or property (also reported under immediate metrics): provide date, location, damage, cause, follow-up;
 - iii. overall condition of vehicles/equipment (subjective judgment by environmentalist); non-routine repairs and maintenance needed to improve safety and/or environmental performance (to control smoke, etc.).
- m. Environmental mitigations and issues (what has been done):
- i. dust: number of working bowsers, number of waterings/day, number of complaints, warnings given by environmentalist, actions taken to resolve; highlights of quarry dust control (covers, sprays, operational status); % of rock/muram/spoil lorries with covers, actions taken for uncovered vehicles;
 - ii. erosion control: controls implemented by location, status of water crossings, environmentalist inspections and results, actions taken to resolve issues, emergency repairs needed to control erosion/sedimentation;
 - iii. quarries, borrow areas, spoil areas, asphalt plants, batch plants: identify major activities undertaken this month at each, and highlights of environmental and social protection: land clearing, boundary marking, topsoil salvage, traffic management, decommissioning planning, decommissioning implementation;

- iv. blasting: number of blasts (and locations), status of implementation of blasting plan (including notices, evacuations, etc.), incidents of off-site damage or complaints (cross-reference other sections as needed);
 - v. spill cleanups, if any: material spilled, location, amount, actions taken, material disposal (report all spills that result in water or soil contamination);
 - vi. waste management: types and quantities generated and managed, including amount taken offsite (and by whom) or reused/recycled/disposed on-site;
 - vii. details of tree plantings and other mitigations required undertaken this month;
 - viii. details of water and swamp protection mitigations required undertaken this month.
- n. compliance:
- i. compliance status for conditions of all relevant consents/permits, for the Work, including quarries, etc.): statement of compliance or listing of issues and actions taken (or to be taken) to reach compliance;
 - ii. compliance status of ESMP/ESIP requirements: statement of compliance or listing of issues and actions taken (or to be taken) to reach compliance
 - iii. other unresolved issues from previous months related to environmental and social: continued violations, continued failure of equipment, continued lack of vehicle covers, spills not dealt with, continued compensation or blasting issues, etc. Cross-reference other sections as needed.

(End of Appendix-8)

APPENDIX-9: SALIENT FEATURES OF SOME MAJOR LABOUR LAWS APPLICABLE TO ESTABLISHMENTS ENGAGED IN BUILDING AND OTHER CONSTRUCTION WORK

- (a) **Workmen Compensation Act, 1923:** - The Act provides for compensation in case of injury by accident arising out of and during the course of employment.
- (b) **Payment of Gratuity Act, 1972:** - Gratuity is payable to an employee under the Act on satisfaction of certain conditions on separation if an employee has completed the prescribed minimum years (say, five years) of service or more or on death the rate of prescribed minimum days'(say, 15 days) wages for every completed year of service. The Act is applicable to all establishments employing the prescribed minimum number (say, 10) or more employees.
- (c) **Employees P.F. and Miscellaneous Provision Act, 1952:** The Act provides for monthly contributions by the employer plus workers at the rate prescribed (say, 10% or 8.33%). The benefits payable under the Act are:
- i. Pension or family pension on retirement or death as the case may be.
 - ii. Deposit linked insurance on the death in harness of the worker.
 - lii. Payment of P.F. accumulation on retirement/death etc.
- (d) **Maternity Benefit Act, 1961:** - The Act provides for leave and some other benefits to women employees in case of confinement or miscarriage etc.
- (e) **Contract Labour (Regulation & Abolition) Act, 1970:** - The Act provides for certain welfare measures to be provided by the contractor to contract labour and in case the contractor fails to provide, the same are required to be provided, by the principal employer by Law. The principal Employer is required to take Certificate of Registration and the contractor is required to take license from the designated Officer. The Act is applicable to the establishments or contractor of principal employer if they employ prescribed minimum (say 20) or more contract labour.
- (f) **Minimum Wages Act, 1948:** - The employer is to pay not less than the Minimum Wages fixed by appropriate Government as per provisions of the Act if the employment is a scheduled employment. Construction of buildings, roads, runways are scheduled employment.
- (g) **Payment of Wages Act, 1936:** - It lays down as to by what date the wages are to be paid, when it will be paid and what deductions can be made from the wages of the workers.
- (h) **Equal Remuneration Act, 1979:** - The Act provides for payment of equal wages for work of equal nature to male and female workers and for not making discrimination against female employees in the matters of transfers, training and promotions etc.
- (i) **Payment of Bonus Act, 1965:** - The Act is applicable to all establishments employing prescribed minimum (say, 20) or more workmen. The Act provides for payments of annual bonus within the prescribed range of percentage of wages to employees drawing up to the

prescribed amount of wages, calculated in the prescribed manner. The Act does not apply to certain establishments. The newly set-up establishments are exempted for five years in certain circumstances. States may have different number of employment size.

- (j) **Industrial Disputes Act, 1947:** - The Act lays down the machinery and procedure for resolution of industrial disputes, in what situations a strike or lock-out becomes illegal and what are the requirements for laying off or retrenching the employees or closing down the establishment.
- (k) **Industrial Employment (Standing Orders) Act, 1946:** - It is applicable to all establishments employing prescribed minimum (say, 100, or 50). The Act provides for laying down rules governing the conditions of employment by the employer on matters provided in the Act and get these certified by the designated Authority.
- (l) **Trade Unions Act, 1926:** - The Act lays down the procedure for registration of trade unions of workmen and Employers. The Trade Unions registered under the Act have been given certain immunities from civil and criminal liabilities.
- (m) **Child Labour (Prohibition & Regulation) Act, 1986:** - The Act prohibits employment of children below 14 years of age in certain occupations and processes and provides for regulations of employment of children in all other occupations and processes. Employment of child labour is prohibited in building and construction industry.
- (n) **Inter-State Migrant Workmen's (Regulation of Employment & Conditions of Service) Act, 1979:** - The Act is applicable to an establishment which employs prescribed minimum (say, five) or more inter-state migrant workmen through an intermediary (who has recruited workmen in one state for employment in the establishment situated in another state). The Inter-State migrant workmen, in an establishment to which this Act becomes applicable, are required to be provided certain facilities such as Housing, Medical-Aid, Travelling expenses from home up to the establishment and back etc.
- (o) **The Building and Other Construction workers (Regulation of Employment and Conditions of Service) Act, 1996 and the Cess Act of 1996:** - All the establishments who carry on any building or other construction work and employs the prescribed minimum (say, 10) or more workers are covered under this Act. All such establishments are required to pay cess at the rate not exceeding 2% of the cost of construction as may be notified by the Government. The employer of the establishment is required to provide safety measures at the building or construction work and other welfare measures, such as canteens, first-aid facilities, ambulance, housing accommodations for workers near the work place etc. The employer to whom the Act applies has to obtain a registration certificate from the Registering Officer appointed by the Government and deposit cess with the concerned authority.
- (p) **Factories Act, 1948:** - The Act lays down the procedure for approval of plans before setting up a factory, health and safety provisions, welfare provisions, working hours, annual earned leave and rendering information regarding accidents or dangerous occurrences to designated authorities. It is applicable to premises employing the prescribed minimum (say, 10) persons or more with aid of power or another prescribed minimum (say, 20) or more persons without the aid of power engaged in manufacturing process.

Note: These features are given for reference only. The Contractor is to be responsible for compliance of all labour laws and regulations in terms of Clause 57 of the Part I: GCC.

(End of Appendix-9)



**BID DOCUMENT
FOR**

DESIGN, SUPPLY, CONSTRUCTION, INSTALLATION, TESTING AND COMMISSIONING OF 2X25KV AC ELECTRIFICATION, SIGNALLING & TELECOMMUNICATION, E&M AND ASSOCIATED WORKS ON DESIGN-BUILD LUMP SUM BASIS FOR DADRI-KHURJA SECTION (APPROXIMATELY 47 ROUTE KM OF DOUBLE LINE) OF EASTERN DEDICATED FREIGHT CORRIDOR

SYSTEMS WORKS CONTRACT PACKAGE 105

Issued on: 14.06.2017

ICB No.: HQ/SYS/EC/D-B/Dadri– Khurja

EMPLOYER'S REQUIREMENTS

PART-2, SECTION-VI,

VOLUME-2: 2x25kv AC TRACTION ELECTRIFICATION AND ASSOCIATED WORKS

**EMPLOYER: DEDICATED FREIGHT CORRIDOR CORPORATION OF INDIA LTD
(A GOVERNMENT OF INDIA ENTERPRISE)**

MINISTRY OF RAILWAYS

COUNTRY: INDIA

Table of Contents

PART 1 – Bidding Procedures

- Section I. Instructions to Bidders
- Section II. Bid Data Sheet
- Section III. Evaluation and Qualification Criteria (Following Prequalification)
- Section IV. Bidding Forms
- Section V. Eligible countries

PART 2 – Employer's Requirements

- Section VI. Employer's Requirements
- Volume 1: General Specifications

Volume 2: Particular Specifications – 2x25 kV, AC Traction Electrification and Associated Works
--

- Volume 3: Particular Specifications – Signalling Works
- Volume 4: Particular Specifications – Telecommunication Works
- Volume 5: Particular Specifications – E&M and Associated Works

PART 3 – Conditions of Contract and Contract Forms

- Section VII. General Conditions (GC) As per FIDIC Yellow Book 1999-Edition
- Section VIII. Particular Conditions
 - *Appendix to Tender*
- Section IX. Contract Forms

PART 4 – Reference Documents

1. Alignment Plans, Yard Plans and Building Plans
2. Power Supply, Distribution, OHE and SCADA system Schemes & layouts and S&T Drawings
3. DFCC-Environmental Assessment Report for Khurja - Dadri Section
4. Environmental Management Framework(EMF) for EDFC
5. DFCC– Resettlement Action Plan for Khurja- Dadri Section
6. DFCC-SHE Manual
7. Specification for 12000hp locomotive and Tractive effort Curve
8. IR's Transmission line Network and DFCCIL's Traction Sub Station (TSS) Connectivity

VOLUME-2: PARTICULAR SPECIFICATIONS: 2X25 kV, AC TRACTION ELECTRIFICATION AND ASSOCIATED WORKS

Table of Contents

CHAPTER 1 - INTRODUCTION AND OBJECTIVE.....	6
1.1 INTRODUCTION.....	6
1.2 OBJECTIVE	6
CHAPTER 2 - OVERVIEW OF THE PROJECT	8
2.1 EASTERN DEDICATED FREIGHT CORRIDOR	8
2.2 POWER SUPPLY FOR THE DADRI – KHURJA SECTION OF EDFC.....	8
2.3 CIVIL STRUCTURE AND TRACK WORK.....	8
2.4 INTERFACE MANAGEMENT AND COORDINATION	9
CHAPTER 3 - SCOPE OF WORKS.....	10
3.1 GENERAL.....	10
3.2 DESIGN BY COMPUTER SIMULATION	11
3.3 SCOPE.....	12
CHAPTER 4 - DESIGN AND FUNCTIONAL REQUIREMENTS.....	23
4.1 GENERAL.....	23
4.2 DESIGN ENVIRONMENT	23
4.3 FUNCTIONAL REQUIREMENT.....	24
4.4 DESIGN PHILOSOPHY AND REQUIREMENTS.....	24
4.5 DESIGN SUBMISSION REQUIREMENTS	28
4.6 PHASES / STAGES OF DESIGN SUBMISSIONS	28
CHAPTER 5 - PERFORMANCE REQUIREMENTS FOR TRACTION POWER SUPPLY SYSTEM.....	36
5.1 GENERAL.....	36
5.2 ROLLING STOCK CHARACTERISTICS AND TRAIN OPERATION DATA	39
5.3 VOLTAGE REQUIREMENTS.....	40
5.4 PERFORMANCE FEATURES	40
5.5 SYSTEM REQUIREMENTS.....	41
CHAPTER 6 - DESIGN CRITERIA & PERFORMANCE SPECIFICATIONS FOR TRACTION POWER SUPPLY SYSTEM.....	43
6.1 CONCEPTUAL POWER SUPPLY ARRANGEMENT	43
6.2 DESIGN OF THE POWER SUPPLY SYSTEM	45
6.3 DESIGN OF EARTH SYSTEM	47
6.4 LIGHTNING ARRESTERS	48
6.5 SHORT CIRCUIT CAPACITY	49
6.6 EHV POWER SUPPLY DESIGN DATA.....	49
6.7 POWER QUALITY	50
6.8 SWITCHGEAR AND PANELS	50
6.9 PROTECTION SCHEME.....	51
6.10 GALVANISATION OF ALL OUTDOOR STEEL WORKS.....	53
6.11 MODULAR EQUIPMENT AND COMPONENTS.....	53
6.12 OUTDOOR SWITCHYARD FOR TSS	53
6.13 ELECTROMAGNETIC COMPATIBILITY (EMC) REQUIREMENTS	53
CHAPTER 7 - POWER SUPPLY CONTROL POSTS AND DETAILS OF EQUIPMENT	59
7.1 GENERAL.....	59
7.2 EXTRA HIGH VOLTAGE POWER SUPPLY TO TSS	60
7.3 TRACTION TRANSFORMER.....	61
7.4 AUTO TRANSFORMERS.....	63
7.5 CIRCUIT BREAKERS FOR 2X25 KV AT SYSTEM.....	64
7.6 BATTERIES AND CHARGERS.....	64
7.7 CONTROL AND POWER CABLES.....	65
7.8 CIVIL WORKS & ILLUMINATION AT TSS, SSP AND ATS (IF ANY).....	67

7.9	CONTROL ROOM & YARD ILLUMINATION.....	69
7.10	NUMBERING OF EQUIPMENT	70
7.11	132KV, 54KV AND 25KV BAYS, LAYOUTS AND BUS BAR ARRANGEMENT ..	70
CHAPTER 8 -	DESIGN CRITERIA AND PERFORMANCE SPECIFICATIONS FOR FLEXIBLE OVERHEAD CONTACT SYSTEM (OHE).....	71
8.1	GENERAL REQUIREMENTS.....	71
8.2	FACTORS GOVERNING DESIGN OF OHE	72
8.3	SECTIONING OF OVERHEAD EQUIPMENT.....	75
8.4	OHE CONDUCTORS	77
8.5	SPLICES, CLAMPS AND OTHER TENSION FITTINGS FOR THE CONDUCTORS	79
8.6	ELECTRICAL CONNECTIONS	79
8.7	FLEXIBLE JUMPERS AND FEEDER CONNECTIONS	80
8.8	FLEXIBLE DROPPERS.....	80
8.9	BURIED EARTH CONDUCTORS (BEC) Connections	80
8.10	CANTILEVER ASSEMBLIES.....	80
8.11	OHE ASSEMBLIES, FITTINGS, HARDWARE.....	81
8.12	AUTO TENSIONING DEVICES	81
8.13	25 KV CABLES.....	81
8.14	STRUCTURE/UPRIGHTS AND THEIR FOUNDATIONS	82
8.15	TOLERANCE IN ERECTION:.....	84
8.16	OUTDOOR STEEL PARTS	84
8.17	ANTI- CLIMBING GUARDS, SAFETY SCREENS, WARNING /DANGER SIGNS etc.	84
8.18	INSULATORS AND SECTION INSULATORS	84
8.19	DESIGN OF NEUTRAL SECTIONS	85
8.20	EARTHING AND BONDING SYSTEMS FOR OHE and STEEL STRUCTURES ..	86
8.21	RETURN CURRENT CONNECTIONS FOR AUTO TRANSFORMER (AT).....	88
8.22	PROVISION FOR FUTURE ADDITIONS AND ALTERATIONS	88
8.23	INTERFACE COORDINATION BY THE CONTRACTOR.....	88
CHAPTER 9 -	LV SUPPLY AT TRACTION SUPPLY POSTS AND S&T INSTALLATIONS FROM 25KV/240V AUXILIARY TRANSFORMER.....	90
9.1	GENERAL.....	90
9.2	SOURCE OF SUPPLY	90
9.3	LV SUPPLY AT STATIONS AND S&T INSTALLATIONS	90
CHAPTER 10 -	SUPERVISORY CONTROL & DATA ACQUISITION (SCADA) SYSTEM.....	92
10.1	GENERAL REQUIREMENTS.....	92
10.2	DESIGN AND PERFORMANCE REQUIREMENTS	96
10.3	DOCUMENTATION	98
10.4	TRACTION POWER SUPPLY FACILITIES TO BE CONTROLLED AND MONITORED	99
10.5	INDICATIVE LIST OF EQUIPMENT TO BE MONITORED AND CONTROLLED AT REMOTE LOCATIONS.....	100
10.6	SCADA SYSTEM PERFORMANCE REQUIREMENTS.....	102
10.7	RAMS REQUIREMENTS	103
10.8	FUNCTIONAL REQUIREMENTS.....	105
10.9	DESIGN CRITERIA AND PERFORMANCE SPECIFICATION	107
10.10	PERFORMANCE SPECIFICATION FOR SCADA SOFTWARE.....	110
10.11	TESTING, COMMISSIONING AND VERIFICATION	132
CHAPTER 11 -	INSTALLATION.....	136
11.1	GENERAL REQUIREMENTS.....	136
11.2	SPECIFIC REQUIREMENTS	137
11.3	CONSTRUCTION AND INSTALLATION PLAN	137
11.4	MATERIAL HANDLING.....	137
11.5	MATERIAL HANDLING PLAN FOR EQUIPMENT.....	138
11.6	WORKS TRAIN	138

11.7	INSTALLATION OF CABLES.....	138
CHAPTER 12 -	TESTING, COMMISSIONING AND HANDING OVER / TAKE OVER	140
12.1	GENERAL.....	140
12.2	CONTRACTORS RESPONSIBILITIES FOR ON-SITE TESTING.....	140
12.3	RE-TESTING	142
12.4	INSTALLATION TESTS	142
12.5	PARTIAL ACCEPTANCE TESTS	144
12.6	SYSTEM ACCEPTANCE TESTS.....	145
12.7	INTEGRATED TESTING AND COMMISSIONING	146
12.8	SERVICE TRIALS	146
12.9	PERFORMANCE VERIFICATION.....	147
12.10	TRACTION INSTALLATION HANDING OVER / TAKE OVER	147
CHAPTER 13 -	SPARES, SPECIAL TOOLS, TESTING & DIAGNOSTIC EQUIPMENT AND MEASURING INSTRUMENTS	149
13.1	GENERAL.....	149
13.2	CONTRACT SPARES	149
13.3	SPECIAL TOOLS, TESTING AND DIAGNOSTIC EQUIPMENT AND MEASURING INSTRUMENTS	151
13.4	TECHNICAL SPECIFICATIONS FOR SPECIAL TOOLS, TESTING AND DIAGNOSTIC EQUIPMENT AND MEASURING INSTRUMENTS	153
CHAPTER 14 -	RELIABILITY, AVAILABILITY, MAINTAINABILITY, AND SAFETY.....	156
14.1	GENERAL.....	156
14.2	RELIABILITY	159
14.3	AVAILABILITY	162
14.4	MAINTAINABILITY	164
14.5	SAFETY	166
CHAPTER 15 -	SUPERVISION AND PLANNING OF MAINTENANCE.....	176
15.1	GENERAL.....	176
15.2	SUPERVISORY STAFF.....	176
15.3	CONTRACTOR'S OFFICE DURING DEFECT NOTIFICATION PERIOD	176
15.4	MEN & MATERIAL REQUIRED DURING DEFECT NOTIFICATION PERIOD....	176
CHAPTER 16 -	TRAINING	177
16.1	GENERAL REQUIREMENTS.....	177
16.2	TRAINING PLAN.....	177
16.3	MOCK UP FOR TRAINING	177
16.4	TRAINING OF EMPLOYER'S TRAINING INSTRUCTORS (ETI)	178
16.5	OPERATIONS STAFF TRAINING	178
16.6	COMPUTER BASED TRAINING (CBT)	178
16.7	TRAINING AND TRANSFER OF SKILLS.....	179
CHAPTER 17 -	OPERATION AND MAINTENANCE DOCUMENTATION.....	181
17.1	GENERAL.....	181
CHAPTER 18 -	INTERFACE MANAGEMENT	182
18.1	GENERAL.....	182
18.2	OBJECTIVE	182
18.3	INTERFACING REQUIREMENTS	183
18.4	INTERFACE	183
CHAPTER 19 -	APPENDICES ON ABBREVIATIONS, SPECIFICATIONS.....	204
Appendix-1	205
Appendix-2	208
Appendix-3	210
Appendix-4	211
Appendix-5	214
Appendix-6	218
Appendix-7	220

Appendix-8	222
Appendix-9	266
Appendix-10	300

CHAPTER 1 - INTRODUCTION AND OBJECTIVE

1.1 INTRODUCTION

- 1.1.1 This document pertains to Employer's requirements of 2x25 KV AC 50 Hz Traction Electrification and Associated Works of the double line Dadri - Khurja section of approximately 47 route kilometers to be constructed and electrified at 2x25 kV Auto Feed system.
- 1.1.2 Eastern DFC Route will be approximately 1847 Km long from Dankuni to Sahnewal (Ludhiana) via Dhanbad – Gaya – Sonnagar – Mughalsarai – Allahabad - Kanpur – Tundla – Khurja - Meerut – Saharanpur & Ambala.
- 1.1.3 EDFC Phase-1 covers the construction of double line electrified section of approximately 343 route km length between Bhaupur and Khurja (under contract package 104) and about 47 Km of electrified double line (contract package CP -105) between Khurja and Dadri, where it links with Dadri – Rewari section (Contract Package CTP-14) of WDFC and Khurja-Pilkahni-Sahnewal Section (under Contract Package 305 & 304) of EDFC .
- 1.1.4 EDFC Phase-2 (CP-204) covers the construction of electrified section of a route length of approximately 388.14 km (Double Line) and approximately 29.15 route km length (Single line) between Mughalsarai and New Bhaupur.
- 1.1.5 EDFC Phase-3 (CP-304 & CP-305) involves construction of single line electrified track of about 404 route km of Khurja-Pilkhani-Sahnewal Section .
- 1.1.6 The EDFC entails construction of mostly double-track, 2x25 kV, 50 Hz, electrified railway lines. The bridges and formation will be designed for 32.5T axle load while the track structure will be designed for 25T axle load operating at train speed of up to 100 Kmph. The Eastern Corridor will handle single stack containers whereas Western Corridor is planned to cater to double stack containers. Up-gradation of transportation technology, increase in productivity and reduction in unit transportation costs have been taken as guiding principles for formulating the project.

1.2 OBJECTIVE

- 1.2.1 These specifications describe the objectives, guidelines and requirements for the design, supply, construction, installation, testing and commissioning of 2x25kV, 50 Hz, AC electric Traction System, Power Supply System, Overhead Equipment (OHE) Supervisory Control & Data Acquisition (SCADA) System, Single Phase 240V power supply by installing 25kV/240V transformers at signal & telecom huts, and stations including other associated works for Dadri-Khurja section of the Eastern Dedicated Freight Corridor.
- 1.2.2 The objectives of this Particular Specification(PS) are:
- (i) To provide a safe and reliable Electric Traction System meeting application duty requirements in conformance to relevant standards and requirements, performance benchmarks and Contractor demonstrates to the satisfaction of the Engineer/ Employer through modelling, simulation and design validation that the performance requirements are met by the designed system.
 - (ii) To use good industry practice so as to minimise the accidents, breakdowns due to workmanship/ material failure and incidents during implementation phase of the contract as well as to reduce the same when the electrified section is in use.
 - (iii) To Design & Provide a system that renders a satisfactory life of 40-years. The Traction

system shall be capable of mid-life up gradation with minimum disruption and be supportable for the installation lifetime.

- (iv) To minimize maintenance costs by design and selection of Maintenance friendly System which have high Availability, low Life Cycle Cost (LCC), higher Meantime between Failure (MTBF) and minimum Maintenance Time to Restore (MTTR).
- (v) To select a 2x25kV Electric Traction System which is easy to install and maintain in the least time possible commensurate with the project aims. To achieve this, the system may be designed on a modular approach such that a generic design is used as far as possible with variations to meet local requirements. The system may be designed in such a way that it can be pre-fabricated and pre-assembled unit and tested away from the site of installation and then delivered to site, installed and commissioned.
- (vi) To ensure that the environmental impact of the electrification and associated works are minimized.
- (vii) To minimize energy usage. The requirement is to reduce energy consumption by employing the energy efficient system design and product specification.

(End of Chapter 1)

CHAPTER 2 - OVERVIEW OF THE PROJECT

2.1 EASTERN DEDICATED FREIGHT CORRIDOR

- 2.1.1 The Dadri – Khurja section, Phase-1 of Eastern Dedicated Freight Corridor (EDFC) is located along the New Delhi – Allahabad section of North-Central Railway zone of Indian Railways.
- 2.1.2 Construction of Dadri – Khurja section will be under CST (Civil, Structures & Track works) contract package CP – 302 and Systems contract package CP – 105. Other linked sections and their construction contract packages are :
- (i) CP – 104, Systems contract package for section Bhaupur to Khurja.
 - (ii) CP – 305, Systems contract package for the section Khurja to Pilkhani.
 - (iii) CP – 303, CST contract package for section Khurja – Palkhani
 - (iv) CTP–14, WDFC's integrated contract package for section Dadri - Rewari
- 2.1.3 The Freight Trains are planned to be hauled by electric locomotives with 3 phase drives and/ or existing electric locomotives of Indian Railways employing up to 12000 HP loco for a single train of 6500T.
- 2.1.4 The Power Supply Installations, OHE and other associated equipment shall be capable of handling projected traffic as per DFCCIL's Train operation Plan as specified in para 5.2 under Chapter-5 of this PS.
- 2.1.5 The Dedicated Freight Corridor will utilize 2X25 kV AT feeding system on the main lines (Double Line) and 1x25kV system in yards and on chords connecting to Indian Railways.
- 2.1.6 The flexible, regulated polygonal Overhead Equipment (OHE) shall be provided for movement of freight trains as per the Standard Schedule of Dimensions (SSOD) of Dedicated Freight Corridor (DFC) – 2013 for Eastern Corridor at a maximum design speed of 120 kmph.

2.2 POWER SUPPLY FOR THE DADRI – KHURJA SECTION OF EDFC

- 2.2.1 Power supply for the Dadri – Khurja section will be tapped from Indian Railways owned 132kV, 3- phase double circuit transmission line network, through LILO (Loop In Loop Out) arrangement at the Traction Substation (TSS).
- 2.2.2 The 132 kV power supply shall be suitably stepped down at the TSS as follows:
- (a) For feeding 2X25 kV AT systems for AC traction OHE.
 - (b) For feeding 240 V, single phase A.C. for auxiliary power supply requirements drawn from Traction feeder circuit through Auxiliary Transformer(s).
- 2.2.3 The power supply shall be monitored and controlled through a Supervisory Control and Data Acquisition (SCADA) system.

2.3 CIVIL STRUCTURE AND TRACK WORK

The Civil structure and Track work have been assigned to Other Contractor through Contract Package CP-302. However the Civil work for power supply control room buildings and structures of TSSs, SSPs, & ATs if any, are covered in Vol.-5: PS for E&M

and associated works.

2.4 INTERFACE MANAGEMENT AND COORDINATION

The contractor shall maintain required liaison and interface with other contractors for the delivery of the work as described in this specification and its annexures.

(End of Chapter 2)

CHAPTER 3 - SCOPE OF WORKS

3.1 GENERAL

3.1.1 The Scope of Work under the Contract as described in this Particular Specification (PS) shall include conducting Traction system simulation study, design, supply, manufacture, construction, Installation, Testing & Commissioning including the technical support, trial runs & integrated testing, supervision of maintenance (during Defect Notification Period), training of the Employer's Personnel, supply of spares, T&P and documentation thereof etc. for a complete system necessary to provide Traction power supply from 132/2x25kV Traction Power Supply System, AT feed system, Over Head contact line Equipment (OHE) complete with Supervisory Control and Data Acquisition (SCADA) system and associated works for Dadri - Khurja Section of EDFC as under but not limited to:

- (1) Study the Employer's requirement, conduct Surveys/Studies, assess site requirement and prepare System's Requirement Specifications (SRS) as compiled from this PS, GS, Standards and other Contract documents;
- (2) Configure Traction system and major components, System architecture, Scheme Designs with Work Breakdown Schedules (WBS) of activities as per the Guidelines/Best practices describing the technology and range of the products with evidences on satisfactory and proven performance;
- (3) Operational & Performance requirement, traffic scenarios and assessing Traction power requirement;
- (4) Conduct Traction Simulation Study for identified train operation plan of the section to determine the sizes of Power supply equipments of TSS and SSPs;
- (5) Preliminary, Detailed Designs and Drawings supported by calculations, reports, Quantity take off sheets, references and RAMS bench marks;
- (6) Preparation of requisite Technical Specifications & Schedule of Guaranteed Performance (SOGP) as required for procurement, Manufacture, supply, construction, installation, testing, trials and integrated testing & commissioning;
- (7) Assurance of System Safety, RAMS and Environmental requirement and Verification & Validation of Reliability performance;
- (8) Technical support for Execution, Supervision of work, Quality Assurance, Site Safety, Health & environment (SHE) including supervision of maintenance during Defects Notification Period;
- (9) Interfaces with IR (Indian Railways) and PGCIL (Power Grid Corporation of India Ltd) for the 132 KV input supply for the TSS from the transmission line network of IR ,
- (10) Interfacing with other associated sub systems.
- (11) Testing & commissioning of 2x25kV AC Traction system and associated works.
- (12) Training of Employer's personnel;
- (13) Supply of spares, T&P and other equipment as specified for Operation & Maintenance.

3.1.2 The scope shall include provision of any/ all necessary /additional equipment and equipment of higher capacities and higher ratings for the systems and sub-systems

necessary for the complete, safe, reliable, operable and maintainable Electric traction power supply system including OHE and SCADA for the Dadri – Khurja Section of EDFC.

- 3.1.3 The scope of work shall include any other associated Works related to satisfactory completion of the Work as defined above and under this specification.

3.2 DESIGN BY COMPUTER SIMULATION

- 3.2.1 The size and materials of the OHE conductors viz. Catenary wire (Messenger wire), Contact wire, Negative Feeder wire are specified in Chapter -8 of this PS. The size of AEW and BEC (if any) shall be determined by the contractor through design & calculation to ensure a safe system as per EN-50122-1 and shall be got approved by the Engineer.

- 3.2.2 The capacities / sizes of equipment in the TSS and SSPs as specified in this PS are nominal deliverable, the Contractor shall make design calculations and conduct Computer based traction power simulation study, Catenary-Pantograph Dynamic Interaction (CPDI) and EMC/EMI studies to determine capacities, ratings, quantities of equipment for TSS and SSPs to meet the operational requirement and shall be got approved from the Engineer for Dadri – Khurja section. The averaging period assumed for determining size of major equipment shall be as per EN: 50388 as applicable. Otherwise, the contractor shall adopt the higher capacities, ratings and quantities as per the results of simulation study conducted by the contractor with the approval of the Engineer.

- 3.2.3 It may be noted that it is the responsibility of the contractor to assess, calculate and propose capacities, ratings, number/quantity of equipment considering Normal/ Emergency Power Failure Scenario including short circuit conditions under stringent application duty and Operational Requirements for Dadri – Khurja section.

- 3.2.4 The Simulation Study shall include as below but not limited to

- (1) Traction Simulation Study: Traction Power Load Flow and Short Circuit study;
- (2) Short time Over load, Short Circuit Current in Normal and extended feed N-1 and N-2 Scenarios over feeding zone;
- (3) The determination of sizes of the Power Supply Equipment, Traction Transformer(s), Autotransformer, CB, CT and Bus bar system etc. under Normal, Emergency feed condition and fault scenarios;
- (4) Optimum Voltage Regulation/ Voltage drop at SP or adjacent TSS, the farthest end for stringent possible scenarios N-1 and N-2;
- (5) Voltage imbalance and THD imposed at Point of Common Coupling (PCC) with IR's transmission line network at normal rated capacity as well as extended feed scenario in full load conditions and mitigation measures thereof, including sizing of mitigation equipment;
- (6) EMI/EMC study;
- (7) Induced EMF on the Signalling & Telecom and other utilities in proximity;
- (8) Rail accessible & Touch Potential within safe limits under Normal & Fault Conditions including configuring earthing and bonding for the entire system (including those on adjacent structure and IR lines running parallel to DFC alignment); determination of sizes / Intervals of interconnection between AEW and

BEC as required and their connection to mast/earth-station and rail without any compromise in safety of public/ Railway maintenance personnel even in case of OHE Short Circuit Fault, while ongoing discontinuity in rail track system due to hair crack(s) as well as discontinuity in AEW;

- (9) Step and Touch potential rise in TSS, SSP and ATS (if any) including Earthing Calculations;
- (10) Insulation Coordination Study;
- (11) Catenary-Pantograph Dynamic Interaction (CPDI) study etc. Technical criteria for the interaction between pantograph and overhead contact line are stipulated in EN 50317, EN 50367 and EN 50119.

3.2.5 The Contractor shall undertake multi train traction power simulations for the entire Dadri – Khurja section, using a proven and fully validated computer based Multi Train Simulation Software. The simulation study shall model normal operations, first failure and second failure conditions.

3.2.6 Computer Simulation Analysis and Reporting

The contractor shall undertake a Computer Simulation Analysis for Dadri – Khurja section for a defined headway as given in table 5.2.2 (Train Operation Plan) and Rolling stock Characteristics as given in table 5.2.1 with Loaded and empty freight train, including the Auxiliary power supply. The results shall be demonstrated through a simulation study Report.

- (A) Simulation -1
Normal feeding arrangement as defined in Clause 5.1.3 of Chapter 5 of this PS.
- (B) Simulation -2
Emergency Feeding Arrangement- First Failure Condition as defined in Clause 5.1.6 of Chapter 5 of this PS.
- (C) Simulation-3
Emergency Feeding Arrangement- Second Failure Condition as defined in Clause 5.1.7 of Chapter 5 of this PS.

3.2.7 Computer Simulation Analysis Output/ Results

The Contractor shall provide the Simulation Results in the form of Simulation Reports for each Computer Simulation Analysis.

3.3 SCOPE

3.3.1 The Scope of Work shall include design, supply, construction, Installation, Testing & Commissioning of Traction power supply system, AT feed system, Over Head contact line Equipment (OHE) and Supervisory Control and Data Acquisition system and associated works for Dadri – Khurja Section of EDFC as under but not limited to:

(1) Configuration of traction power supply system

Indicative General Arrangement Diagram (GAD) for Traction Power Supply System and Power Supply Installations are shown in the Part-4 Reference Document. The configuration of traction power supply system as required shall comprise of the following but not limited to:

- (i) Traction equipment, Traction Transformers, Auto transformers as required and Bus bars suitably designed/ capable to feed the extended feed zone as per application duty requirement;
- (ii) Control & Protection system and Circuit Breakers etc. as required to automatically isolate faulty section/ equipment;
- (iii) Traction Power Return current, Earthing & Lightning protection etc.
- (iv) Power Quality Monitoring, Controlling Devices and other equipment and provisions as described in the PS to improve power quality, and keep harmonics and voltage unbalance within the specified limits at rated Capacity or as specified in this specification;
- (v) Provision of Traction substation (TSS), Sub Sectioning & Paralleling Posts (SSPs) and Auto Transformer station (ATS) if any, as described in relevant Chapters of this specification and as under:

a. **Traction Substation**

Provision of one Traction Sub-Station (TSS), for traction power supply to 2x25kV AT Feeding System, with double circuit 132kV supply tapped from IR's transmission line network for the TSS. Typical indicative TSS arrangement is enclosed in Part-4 Reference Documents.

The provision at the TSS shall include the gantry for termination of 132 KV LILO (Loop in Loop out) feeders of IR and PGCIL, associated switchgears as required for satisfactory LILO operation, along with SCADA interface and LILO control workstation at IR end, through secured web server as required, shall be executed by the contractor.

- b. Two (2) Sub Sectioning and Paralleling Posts (SSPs).
- c. Auto-transformers shall be provided at the TSS (as required as per design) and at SSPs.
- d. No outdoor stand-alone Auto-Transformer station is envisaged in mid-section. However the number, Capacity/ ratings of midsection Auto-Transformer Station (ATS), required if any, shall be finalised by Simulation Study and provided as required.

(2) Supervisory Control & Data Acquisition (SCADA)

SCADA system shall be provided at centralized Operation Control Center (OCC) to control & monitor all power supply Installations for the entire Dadri – Khurja Section of the EDFC, as described in the relevant chapters of this Particular Specification, including the provisions for interlocking / interface arrangement with the SCADA system of adjacent sections.

(3) 240V, single phase, A.C. Auxiliary power Supply.

- (i) 240 V A.C. single phase, Low Voltage (LV), Auxiliary Power Supply shall be drawn from 25 kV Traction circuit through 10 kVA Auxiliary Transformers at all Power Supply Control Posts i.e. TSS and SSPs. However, TSS shall be provided with additional 100 kVA Auxiliary Transformers including all terminations and cabling.
- (ii) 240V AC, single phase, LV, Auxiliary Power Supply for other users from

25kV OHE Power Distribution System shall be provided for Signal & Telecom installations and Station Operations along the entire route with redundancies and Automatic Source Transfer / Change over system as required.

(Note: The provisions for tapping of 240V Power supply shall be as defined in Volume: 5-PS for E&M and associated works.

(4) Execution of Cables, Cable containment system and feeder network including the following:

- (i) 25 kV AC cable/ overhead connections from TSS/ SSPs/ ATS, if any, as required, to OHE.
- (ii) 25 kV AC overhead connections from ATS (if any) to overhead equipment;
- (iii) Return current cabling and bonding along the alignment and in yards;
- (iv) Auto Transformer connections to the rails;
- (v) All connections for traction Rail bonding;
- (vi) Any other cable and Cable terminations etc.as required of appropriate ratings.

(5) 2x25kV AT Feed Overhead Equipment (OHE)

The OHE system configuration as required shall comprise of the following but not limited to:

- (i) 2x25kV AT Feed Overhead Equipment (OHE) on main lines being constructed by CP-302 CST contractor, comprising of Traction & Negative Feeders, Catenary & Contact wires;
- (ii) 1x25 kV OHE for loop lines and yard lines;
- (iii) 1x25kV OHE system for the connecting chords to Indian Railways up to IR meeting point as per interface plan.
- (iv) 1x25 KV OHE system (as per IR specifications, with the approval of the Engineer) for new lines being constructed by CP-302 CST contractor in the IR yard (if any), as per the yard plan.
- (v) Aerial Earth Wire (AEW);
- (vi) Buried Earth Conductor (BEC), as required.

(6) Earthing and Bonding plans shall be prepared and implemented as required for Dadri – Khurja section and adjacent Indian Railway tracks or any other Utilities or metallic structures in proximity belonging to other independent authorities to provide protective provisions against EMI from 25kV traction currents and to limit touch potentials as a result of Simulation study.

(7) Protective measures to mitigate Electromagnetic interference shall be implemented based on the results of traction simulation study and EMC/EMI study conducted by the contractor and as reviewed and accepted by The Engineer. Protective provisions would include provision of Aerial Earth Wire (AEW) mounted on masts with earth connections at regular intervals including connection at requisite intervals to Buried Earth Conductors (BEC) as required to provide an energy efficient/low resistance return current path, minimise the impact of the

interference, the induced voltage on utilities along the track and to limit the rail potential rise in conformance to relevant standards. The BEC (as required) shall be capable to handle the Return current as may be witnessed during the broken rail or Rail Maintenance, without raising the touch potential beyond acceptable limit and compromise the safety of General public or Rail personnel in proximity / touch. The contractor shall be required to model the rail conductor system network (comprising of CW, catenary, Negative feeder, AEW, BEC and both rails of each line) and demonstrate that the potential rise in all possible OHE/Power fault case scenarios remains lower than the permissible limit at any point as per relevant standards including step and touch potential while on going discontinuity in Rails unnoticed like hair cracks etc. and discontinuity of AEW due to failure/theft if any in two independent systems.

(8) Electrical safety and Clearances

- (i) Provisions for electrical safety i.e. Rubber mats, First aid boxes, Personal Protective Equipment (PPE) like, Goggles, Gloves, Helmets, eyewash kits, danger plates, fire-fighting equipment. Shock treatment Charts, Signage, caution boards, labels and notices in adequate number shall be exhibited at conspicuous locations being statutory requirement.
- (ii) Working and Electrical clearances more than or equal to the prescribed minimum clearances as identified in National Electric Code (NEC) or NFPA-70 or prescribed by IR/ACTM, whichever is higher.
- (iii) Insulation over catenary and Feeder wire under all the Bridges, FOBs, ROBs and Over-line structures. The Insulation level of the insulating sleeves considered, if any shall conform to EN50124-1.

(9) All civil works or modifications required for installation of the equipment and restoring to final finishes by the contractor shall include but not limited to

- (i) Survey, ground investigation, soil resistivity, and hydrological studies of the site and consider for the design and Implementation including the sharing of the Video-graphic evidences of natural soil/ land levels with the Engineer.
- (ii) Construction of Control Building at TSS, SSP etc. meeting the functional and technical requirement with required clearances and safety provisions as specified in Volume-5: Particular Specifications for E&M and Associated Works.
- (iii) Preparation and levelling of ground required for the work including earth filling for TSS / SSP and other buildings constructed under this package and to lift the land to obtain the Finished Ground Level (FGL) within the Right of Way (ROW) for traction power installations,
- (iv) Spreading of Gravels in the TSS, SSPs and other places as required.
- (v) The Cable containment system and RCC trenches with modular trench covers, with metallic frame for ease of manual lifting; as approved by the Engineer.
- (vi) Construction of road(s) and pavements within power supply installations suitable for movement of heavy equipment,
- (vii) Construction of Boundary wall/ fences, drainage and sewerage,
- (viii) Construction of foundations for traction equipment / component and

containments, Equipment mounting structures, OHE Masts, Portals and Gantries etc.

- (10) 'Mandatory Spares', special tools, testing and diagnostic equipment and measuring instruments as described in relevant chapter, shall be supplied at least 180 days before the revenue operation. The contractor shall also provide the List of 'Recommended Spares as prescribed by the Manufacturer' mentioning the Price of all such recommended Spares, which, if Employer wants, can procure. All kinds of Consumable materials not limited to printer cartridges, tapes and papers etc. shall be supplied by the contractor for the period up to the handing over of the work to the Employer. The spares consumed/ utilised by the Contractor during the Defect Notification Period shall be made good by the contractor.
- (11) The Electric Traction system designs shall be co-ordinated with the civil infrastructure design with regards to site access control; fencing; paving; drainage; access roads; earthing system (earth resistivity); cables, under track / through crossings, between traction power substations, Switching Stations and Signalling, and between traction power substation and the IR Transmission Line Network .

3.3.2 Services

The Services to be performed by the Contractor shall include, but not be limited to, the following:

- (a) Ground Investigation, hydrological survey and report thereof before Preliminary Designs including identification of locations and construction of foundations for trackside OHE equipment and for other equipment in TSS, SSPs and ATS (if any).
- (b) Preparation & implementation of Work Program and Management Plans as given in GS.
- (c) Study of Employer's Specifications & Deliverables, preparation of SRS and Verification & Validation (V&V) Criterion.
- (d) Preparation of Scheme/ Preliminary Design with Equipment layouts & Drawings, performance Parameters, Detailed design, calculations, studies and drawings.
- (e) Preparation of Technical Specifications and Schedule of Guaranteed Performance (SOGP) Particulars for system equipment,
- (f) Proposals on makes of material in required Format as prescribed with evidences on conformance for approval of the Engineer.
- (g) Procurement/ Supply, construction, system quality Assurance, installation, Inspections, testing and commissioning of the complete traction system
- (h) Organising & witnessing of Prototype and Factory Acceptance Testing as per test plan and Stand-alone tests of the Power Supply System, OHE and SCADA system/ subsystem/ equipment etc.;
- (i) Presentations, reviews and audit support as specified in this Specifications.
- (j) Interface management

The contractor shall develop the Electric Traction System with key interface requirements with other sub-systems requirements and deploy the competent professionals for the management of Interfaces and Integration with other systems/ contractors.

- (k) Taking possession/access of the site, execution of the work and return/handing over.
- (l) Trial runs and integrated testing & commissioning with other systems like track, and Rolling stock.
- (m) Supervision of maintenance during Defect Notification Period; Defects Liability Obligations including those of Permanent Works after commissioning as stipulated.
- (n) Training for Employer's personnel.
- (o) Decommissioning, removal and/or disposal of temporary works.
- (p) Obtaining statutory clearances including preparation of Documentation and submission of information asked for by statutory bodies e.g. Government of India, Ministry of Railways, Commissioner of Railway Safety, and Electrical Inspector to Govt. of India (EIG) as directed by the Engineer.
- (q) EMC Management.
- (r) Earthing & Bonding Management.
- (s) Taking Power Blocks and Permit to Work for the execution of new work under the scope as required, including that for dismantling involved if any.
- (t) GPS Mapping of all the OHE masts/ portals of Entire OHE section to get X, Y & Z Coordinates for each mast location using best accuracy rendering GPS method as approved by the Engineer. The Mapping data shall be submitted by the Contractor in hard as well as in Soft copy to the Engineer for approval.

3.3.3 Documentation

The documentation to be delivered by the Contractor shall include but not limited to the following items:

- (1) Following documents, shall be prepared and got approved from the Engineer (who shall obtain consent of Employer): -
 - (a) Design Manual,
 - (b) Simulation Studies,
 - (c) EMC/EMI Control & Management Plan,
 - (d) Earthing and Bonding Management Plan,
 - (e) General Traction Power Supply Diagram and Sectioning Diagram
 - (f) Pollution Mapping of the section,
 - (g) Protection system scheme with relay coordination and Calculations,
 - (h) SCADA System documents,
 - (i) Interface Management Plan,
 - (j) Test Plans and reports.

The Test Plans should include but not limited to:

- (i) Test to be performed furnishing a list of the tests identified in the relevant Standards and Technical Specifications and Tests Proposed to be carried out and witnessed with break up in to FAT, Site tests

- and Acceptance Tests,
- (ii) Test Procedures for each test proposed including precautions to be taken during tests,
 - (iii) Test equipment/ instruments and measuring instruments to be used,
 - (iv) Parameters to be checked,
 - (v) Criterion for acceptance / rejection, acceptable Values,
 - (vi) Test Program
 - (vii) Any other relevant information,
- (k) Power Quality Study Report including the possible power correction methods with harmonic suppression.
 - (l) Installation Plan, Testing and commissioning plan.
 - (m) Technical Specifications for Power Supply System, OHE and SCADA System etc. to be drawn by the contractor, based on functional specifications for the items proposed to be used for the first time on Indian Railways.
 - (n) Demonstration results of Fault Simulation and Fault Localisation at locations as desired by the Engineer.
 - (o) Method statements, Work Plan, Quality assurance, Safety plans including site safety etc. as specified in GS.
- (2) Following documents shall be approved by the Employer to be submitted through the Engineer:
- (a) Training plan;
 - (b) Operation and Maintenance plan.
- (3) The documents to be delivered by the contractor shall include but not be limited to, the following:
- (a) Preliminary Design Stage**
 - (i) Inception report including**
 - a. Understanding of Project, Scope of Work, mobilisation of resources/office/Organisation/qualified design team/Key personnel, describe Approach & Methodology for 2x25kV AT Feeding System.
 - b. Initial work Program,
 - c. Study of Employers' PS, GS, relevant standards, Employer's schemes/ Drawings and other contract documents and preparing System Requirement Specifications (SRS), Verification and Validation Criteria,
 - d. Design manual describing design philosophy, Design Quality assurance, Design Verification checklists etc. planned to be adopted to deliver a safe and reliable Traction system.
 - (ii) Simulation Studies Results reports and calculations.**

(iii) Preliminary Design

- a. Assessment of Power Requirement based on Simulation Study results;
- b. Preliminary design including power supply diagram, sectioning diagram, SCADA and Traction system architecture
- c. Assessment of possible power failure scenarios, Normal and Peak current requirement under failure and Power supply configuration under such failure scenarios and the Power / peak current requirement;
- d. Calculations on Sizing of all Power Supply Equipment and conductors but not limited to :sizing of Jumpers, droppers, Cantilevers, Masts, foundations, conductor sag, Auto tensioning devices, OHE mechanical loading Calculations /Selection of OHE masts, foundation design, feeder cables, Cable Containments, Sizing of CB, CT, Bus bar and other provisions thereof;
- e. Earthing and Earth Mat calculation with Step and Touch potential at TSS , SSPs and ATs (if any);
- f. TSS & SSP Equipment layouts suitable to Land size and shape;
- g. Report on Design of protection systems including Lightning / Surge protection measures;
- h. Proposed design & calculations of Power Quality correction equipment and harmonic suppression;
- i. Electrical Clearance study Report;
- j. Documents for the items/ equipment not covered by RDSO specifications requiring Cross Acceptance.

- (iv)** Preliminary Design Report with Definitive Scheme design, Configuration of Electric Traction System, Power Supply installations, Equipment capacities/ Ratings, OHE Installations, OHE Conductors & sizes as confirmed by simulation study, Insulation Coordination study Report, Clearance study report, schemes and Arrangement Drawings, SCADA System, Strategy to Integrate with the IR Network, Interface Management Plan, Design submission Program.

(b) Detailed Design Stage

- (i) Final Design Scheme as concluded after the Preliminary design approval and observations thereon by the Engineer on Preliminary Design;
- (ii) Detailed Design Calculations of equipment and components as required;
- (iii) Evidences of the design compliance on simulation results;
- (iv) Technical Specifications (TS) to be drawn by the contractor based on functional specifications particularly for the items proposed to be used

for the first time on Indian Railways. The Contractor shall use the Technical specification of RDSO where available. The TS prepared by the Contractor shall be generally in the format of RDSO Specifications;

- (v) Schedule of Guaranteed Performance (SOGP) Matrix;
- (vi) Detailed design Drawings;
- (vii) Design Reports complete with Executive summary, Methodology, Relevant standards, assumptions, Input data, Calculations, Study results and Recommendations;
- (viii) Study reports as relevant to conclude the designs;
- (ix) Detailed interface reports and Detailed interface Design/ Drawings(DID);
- (x) Hazard identification, Preliminary Hazard Analysis (PHA), Hazard Log and Mitigation documentation and Hazard operability;
- (xi) Earth Resistivity Measurement;
- (xii) Detailed EMC/EMI control & management plan;
- (xiii) Detailed Earthing and bonding plan;
- (xiv) Protective system proposed along with automatic fault locator (AFL) with its suitable algorithm to isolate the faulty section on OHE and feeder with high degree of accuracy;
- (xv) Pollution mapping for identification of polluted zones warranting use of longer Creepage path insulators;
- (xvi) System Reliability, Availability, Maintainability and Safety Assessment reports (RAMS);
- (xvii) Systems integration plan and proposed Integrated testing & commissioning;
- (xviii) Training Plan;
- (xix) Operation & Maintenance Plan;
- (xx) Equipment, conductor & fitting specifications and their Schedule of Guaranteed Technical Performance (SOGP).

(c) Construction & Installation Stage

- (i) Work Plan;
- (ii) Procurement Plan;
- (iii) Quality Assurance and Quality Hold Points
- (iv) Proposal on product makes with details on Makes, OEM, MTBF, MTTR, Maintenance Support in requisite format and Approval thereof on the Manufacturer/ brand, Approval of samples, first fix and Mock-up installation before mass use/ replicating elsewhere;
- (v) Manufacturer drawings needed for installation;
- (vi) Construction and Installation Plan;

- (vii) Prototype Test Plan;
- (viii) Type test reports for equipment or components selected;
- (ix) Factory Acceptance Test Plan for equipment ;
- (x) FAT Program;
- (xi) RAMS Plans;
- (xii) Layout Drawings of equipment to be installed;
- (xiii) Inter connection Drawings;
- (xiv) Site test report of equipment;
- (xv) Updated Earthing & Bonding plans ;
- (xvi) Updated EMC Control Plan and certificates;
- (xvii) Updated traction simulation model verified against testing data;
- (xviii) Site access control system proposed.

(d) As built documents

- (i) As Built Drawings;
- (ii) Testing & Commissioning Reports/documents as required by the Engineer;
- (iii) All other records of Construction for PSI Installations , OHE including hidden parts;
- (iv) RAMS demonstration results;
- (v) Operation and Maintenance (O&M) Manual of the equipment covering Installation, operation and maintenance instructions;
- (vi) Preparation of 2x25kV AC Traction Manual;
- (vii) Other documentation as required by the Engineer.

(e) Operation and Maintenance (O&M) Manuals as specified in Chapter-17.

3.3.4 Items of work excluded from the scope

- (1) The following items of work are not included in the scope. However, the Contractor shall provide timely inputs as necessary to the relevant Other Contractors /agencies.
 - (a) Electrification Works pertaining to yard modifications on IR excluding Electrification of New Lines being constructed by CST Contractor CP 302 in the IR yard.
 - (b) 132 KV transmission line to TSS Gantry. (However the provisions related with gantry, associated switchgears in TSS along with SCADA interface and LILO operation control workstation at IR end through secured Web server, as required, shall be executed by the contractor for termination of 132 kV Loop In Loop Out Feeders of IR),
 - (c) Statuary signage and height gauges at level crossings /RUBs and protective screens at ROBs and FOBs shall be provided by CST contractor. However the contractor shall coordinate with CST contractor.

- (d) Trees in the alignment or in TSS/SSP if any shall be removed by the CST contractor. However the contractor shall coordinate with CST contractor.
- (e) Arrangements at OCC theatre as below:
 - (i) OCC Building.
 - (ii) All E&M work (However, the contractor shall tap power through his own cabling and cable containment as require for CP 105 scope of work);
- (2) All the above items should also form part of the Interface Management Plan to be prepared by the Contractor.

(End of Chapter 3)

CHAPTER 4 - DESIGN AND FUNCTIONAL REQUIREMENTS

4.1 GENERAL

- 4.1.1 The design, supply, construction, installation, testing and commissioning of the Traction Power Supply System, SCADA system, auxiliary power supply at 240 V and the OHE shall meet the design and performance requirements within the design environments as specified.
- 4.1.2 The Contractor shall carry out all investigations necessary for the design of the Permanent Works and enable the determination of the methods of construction and the nature, extent and design of Temporary Works.
- 4.1.3 The Contractor shall study environmental factors and design the Traction Equipment to render the best performance in the environment they are subjected to as per application duty and to determine suitable methods of manufacture and installation, both for Temporary and Permanent Works. In particular the Contractor shall ensure that the dusty environment, rocky terrain and earth resistivity do not have detrimental effect on the functionality, reliability or long term maintainability of the Permanent Works.

4.2 DESIGN ENVIRONMENT

The traction power system shall be fully operable and maintainable in the following climatic and atmospheric conditions:

Ambient air temperature	-5 ⁰ C degrees to +50 ⁰ C
Average ambient temperature for one year	35 ⁰ C
Maximum solar gain of metallic object under Sun	1 kW/Sqm
Maximum relative humidity	100%
Annual Rainfall	Dry Arid regions and also heavy monsoon affecting regions with rainfall ranging from 1750mm to 6250mm.
Maximum number of thunderstorms days per annum	85
Maximum number of dust storm days per annum	35
Number of rainy days per annum	120
Basic wind pressure *	120 – 200 kgf/m ² as per wind map based on IS – 875. For long bridges (more than 150m) and within 100m from their abutments on either side and on banks, where the height of the catenary above surrounding mean retarding surface is more than 30 meters, the specified 25% reduction in wind pressure shall not be reckoned for purposes of design.
Creepage distance for (i) Extreme pollution condition (ii) Polluted conditions	As per IEC 60815 – 2008
Horizontal Seismic Zone	Refer IS 1893 Part 1 for earthquake mapping

* The maximum wind pressure for the specified work area shall be obtained from the wind map as per IS 875 and used for the mechanical designs with the approval of the Engineer. The Thermal withstand capacity shall be considered at 0.5m/sec wind velocity.

4.3 FUNCTIONAL REQUIREMENT

4.3.1 The 2x25kV Traction Power Supply Systems on the Eastern Dedicated Freight Corridor (EDFC) shall ensure availability of reliable 2x25kV AT Feed (25kV AC for the yards) to the electric trains via overhead equipment and single phase, 240 V, AC supply for S & T installations along the route.

4.3.2 The Traction Power Supply System shall be monitored & controlled through a Supervisory Control and Data Acquisition (SCADA) System on the Eastern Dedicated Freight Corridor.

4.4 DESIGN PHILOSOPHY AND REQUIREMENTS

4.4.1 Conformity with Governing Specifications and Statutory Requirements

- (1) This Particular Specification (PS) shall be read in conjunction with the Conditions of Contract, the General Specifications (GS) and documents forming part of the Contract.
- (2) In the event of a conflict between the provisions of GS and this PS, the provisions of this PS shall prevail.
- (3) In addition to the codes, standards and provisions mentioned in these specifications, the codes and standards that may also be applicable are:
 - (a) Relevant Indian Standards,
 - (b) Relevant RDSO specifications& standards,
 - (c) Indian Railways AC Traction Manual (ACTM),
 - (d) Design Manual for Electric Traction,
 - (e) CEA safety regulations 2010 (Measure relating to safety & electric supply),
 - (f) Safety Guidelines 2010 issued by CEA,
 - (g) IEC (INTERNATIONAL ELECTROTECHNICAL COMMISSION) Standards,
 - (h) EN (NORME EUROPÉENNE) European Standard,
 - (i) BS (British Standards),
 - (j) IEEE (Institution of Electrical and Electronics Engineers) Standards etc.
- (4) In case of any conflict or inconsistency between the provisions of the codes/ standards as mentioned above and provisions contained in these specifications the provisions in these specifications shall prevail. However the approval of the Engineer shall be obtained to follow the relevant codes/ specifications. The decision of the Engineer shall be final.
- (5) The Contractor shall prepare and submit Technical Specifications (TS), which shall provide clear description of Functional & Performance requirements of each system, sub-system and equipment proposed along with Schedule of Guaranteed Performance (SOGP) matrix. The TS shall be drawn from the System

Requirement Specification (SRS) as developed by the Contractor from the PS duly interpolated from the provisions in GS, contract documents and the relevant standards, The TS shall be submitted for the approval of the Engineer accompanied with the Para Number wise 'Compliance statement on SRS' along with NIL Exception statement on SRS. 'Exception statement' with Un-complied item (s) if any of SRS shall be submitted to the Engineer with mitigation measures and compliance stage, However, no deviation shall be permitted. The Technical Specification (TS) shall describe acceptable levels of performance for system/subsystem equipment / components within the environment condition stipulated above.

- (6) The TS prepared by the Contractor shall include System / Sub-system/ Equipment wise Schedule of Guaranteed Performance (SOGP) in tabulated format comprising of following Information but not limited to:
 - (a) System / sub-system /Equipment name,
 - (b) Environment Condition ,
 - (c) Designed temperature and De-rating if any required to the standard rating considered for highest ambient Temperature the equipment may experience,
 - (d) Design life,
 - (e) MTBF,
 - (f) MTTR,
 - (g) Schedule of Guaranteed Performances (SOGP) as applicable,
 - (h) Testing & Commissioning requirements,
 - (i) Mechanical & Electrical Interface with others,
 - (j) Design Verification & Validation (V&V) check list,
 - (k) Supply, Installation, Testing & commissioning (SITC) check list.
- (7) SOGP shall be provided by the Contractor for each major equipment which shall be got approved from the Engineer, The Contractor shall identify the Name of the vendor, Place of Manufacture, manufacturer model/ part number of each system/ equipment, which he plans to install along with design life. The Contractor shall submit a proposal of approval in the requisite format as approved by the Engineer.

4.4.2 Proven Design and Cross acceptance criteria

- (1) The Contractor shall develop the design based on this Particular Specification and good Industry Practices. The design details shall be submitted with supportive technical data/evidence of similar design and calculations to the Engineer for review and approval.
- (2) The System, including all Sub-systems and Equipment shall generally be of approved RDSO/ CORE designs/specifications, wherever applicable. Such items:
 - (a) If Procured locally, shall be procured from RDSO/CORE approved regular sources only. If there is no regular source then the material can be sourced from a developmental source. List of sources are available at RDSO / CORE websites. These items shall be subjected to prototype testing as per relevant Specifications. Prototype test shall be exempted if the test was

carried out in last three (3) years from One month prior to date of Second stage of Bid Opening or later and report of the same is submitted otherwise fresh prototype test shall be carried out and certificate/report submitted.

- (b) If imported, the cross acceptance criteria as given below shall apply.
- (3) The Contractor shall develop design and technical specifications for other items based on draft specifications (of RDSO) / functional requirement, if available, and prepare detailed specifications for approval of the Engineer.
- (4) Cross acceptance criteria shall be applicable on the following:
 - (a) Items not covered by RDSO/ CORE specifications OR,
 - (b) Items being adopted for the first time in Indian Railways.
- (5) The cross acceptance criteria shall be as under:
 - (a) Three years satisfactory performance on AC Traction System from one month prior to date of Second stage of Bid Opening or later. (For Circuit Breakers and Interrupters above 25kV, 25kV feeder wire, AEW, BEC as required and SCADA system, Three (3) years satisfactory performance on power utilities shall also be permitted.)
 - (b) The manufacturer should have supplied the equipment of minimum 70% rating of equipment offered. The Contractor shall furnish the details of its proven performance (certificate from the user) for such items.
 - (c) The Manufacturer should have supplied at least 50% quantity to be used in this contract in last seven years OR they can supply, maximum two times the quantity supplied in last seven years (one month prior to date of Second Stage Bid Opening.
 - (d) Prototype test report/certificate for offered item is to be submitted. Fresh prototype test is to be conducted, if the same has not been carried out;
 - (i) In last three(3) years from one month prior to date of Second stage of Bid Opening or later;
 - (ii) Considering the environmental conditions as specified in this PS.
 - (e) The Manufacturer shall have to support maintenance and repair of the equipment in India and supply spares till the design life of the material such as transformers etc. in India. The contractor shall submit an undertaking in this effect from the Original Equipment Manufacturer (OEM).
 - (f) The Original Equipment Manufacturer (OEM) may transfer technology to any Indian Company for manufacture and supply of 50 % quantity used in the project, provided the OEM has technology tie up with the Indian manufacturer and the OEM signs Joint Deed of Undertaking by the Qualified Equipment Manufacturer along with the contractor and Indian Equipment Manufacturer / Indian Partner as per proforma appearing in this specifications at Appendix 10 of chapter 19.
 - (g) In order to ensure satisfactory Transfer of Technology(TOT), the OEM shall provide with DFCCIL and Indian Manufacturer:
 - (i) Design Drawings,
 - (ii) Manufacturing Drawings,

- (iii) Process sheets for Manufacturing,
 - (iv) Inspection and Quality Management procedures,
 - (v) Complete Material Specifications,
 - (vi) Jigs and Fixtures,
 - (vii) List of Machinery and Plants along with their functional specifications, which are needed for manufacture,
 - (viii) Manufacturing supervision,
 - (ix) Inspection by OEM's representative,
 - (x) Extended Guarantee for 3 years for indigenous equipment after expiry of Defect Notification Period,
 - (xi) Any other assistance, reasonably required,
- (6) Any approval to the prototype tests by the Engineer in no way shall absolve the contractor of his responsibility for the equipment, under the terms of the contract.
- (7) The prototype test already done shall be valid only if it was done on identical equipment (same rating), manufactured with identical components / raw material, at the same manufacturing facility and to identical Quality standards.

4.4.3 The designs shall be evolved along the following guiding principles:

- (1) Service proven Design of same type;
- (2) Low life cycle cost;
- (3) Low maintenance cost;
- (4) Use of interchangeable, modular components;
- (5) Extensive and prominent labelling of parts, cables and wires;
- (6) Use of unique serial numbers for traceability of components;
- (7) High reliability;
- (8) High Availability;
- (9) Low energy loss;
- (10) Fail safe design;
- (11) Adequate redundancy in system;
- (12) Compliance with relevant standards;
- (13) Maintainable throughout the design life;
- (14) Compliance with all statutory regulations.
- (15) Future expandability

4.4.4 The contractor shall select a technology and equipment rendering equivalent or more life and better performance parameters as approved by The Engineer.

4.4.5 The General arrangement shall ensure that failure of one equipment/ component or any single point failure does not impact the availability/ performance of the Installation/ Equipment.

4.4.6 The Contractor shall detail the maintainability requirements, and demonstrate that system maintainability conforms to the claimed system reliability and availability performance. The Contractor shall demonstrate that maintenance errors have been considered, and, as far as practicable, the risk of maintenance induced faults is mitigated in the design.

4.4.7 The Contractor shall demonstrate, to the satisfaction of the Engineer, that Insulation co-ordination for all electrical equipment is incorporated in the design of the Traction Power, OHE and SCADA system.

4.5 DESIGN SUBMISSION REQUIREMENTS

4.5.1 The Contractor shall demonstrate that designs for the Contract are in accordance with Employer's Requirements as specified in this PS, GS and Conditions of contract. The Contractor shall submit to the Engineer for review, relevant design information and drawings as identified under each phase/stage. Such submissions shall incorporate the relevant Standards as applicable.

4.5.2 The design submission schedules and their stages are detailed in relevant chapter of General Specifications.

4.6 PHASES / STAGES OF DESIGN SUBMISSIONS

There are four (4) stage submissions covering the Design Phase/stage viz. Preliminary Design, Detailed Design, Construction/Installation Design and finally the As-Built Documents.

4.6.1 Preliminary Design

In the preliminary design phase/stage the contractor shall submit inception report, Scheme designs and system simulation reports as specified in GS and this PS.

(1) Inception Report and Traction Simulation Study Reports:

- (a) The **Inception Report** describing Approach/ Methodology to the design & execution of 25kV AT feeding System based on a study of freight systems around the world and to provide a cost effective and reliable design, Mobilization of qualified Design team, Review of Particular specifications and prepare SRS, schemes of the design, the Detailing on the Electric Traction System, Power Supply Installations, Traction Transformer (s), Auto Transformers, TSS/SSP, OHE installations, Conductors & Wires, SCADA and RAMS and other performance obligations as described in the scope of work in the relevant chapter of this PS for the Dadri – Khurja section.
- (b) Simulation Studies shall be undertaken based on the Employer's requirements and DFCCIL's Train Operation plan. The study shall determine the capacities of various elements, components as indicated in Clause 3.3 and shall form the basis of details in the Inception Report.
- (c) The Inception Report and Simulation Study Reports along with sufficiently detailed drawings and documents shall be submitted for the purpose of review and approval of the Engineer. The approved inception report and traction simulation report shall then form the basis for the designs.
- (d) The preliminary design shall incorporate all design requirements including standards, codes, performance requirement, design stresses and strains,

electrical & mechanical properties of materials and all other documents or matters which are relevant to and govern the design. The Contractor shall furnish a Design Manual, which shall refer to all materials, codes and standards used, making clear their specific applications. The Design shall be produced so that it can be used by those involved in the preparation or review of the design of the Works as a comprehensive reference text and efficient working document.

(e) **Electric Traction System design**

Based on studies as detailed above, the contractor shall develop designs of the System and Sub-systems for traction power supply and distribution, finalizing ratings of the Equipment, switchgear including Control & Protection Systems and SCADA System. Safety Plan for the entire network including the work to be done for other contractors/ agencies and IR for earthing and bonding, shall be drawn for approval by the Engineer. Works of Earthing & Bonding required on the adjacent Railway network of the Indian Railways of both electrified and non-electrified systems, in proximity to the Freight Corridor, against induced current from 25kV AT Feeding System shall also be implemented, so as to provide a safe environment. The Preliminary and Detailed Design Report submission shall also provide details for, but not limited to, the following:

- (i) The design shall be coordinated to accommodate the requirements of adjacent sections. Final track-work, including drainage and service roads and any specified design requirements that those systems or facilities may dictate for the operation and management of the system.
 - (ii) The alignment of storm water drains along the track shall be coordinated with Civil Contractor (CP-302) to ensure that the alignment of the OHE structures and storm drains do not obstruct each other.
 - (iii) The OHE final design shall be engineered by the Contractor with consideration to the design criteria, specifications, codes and standards contained or referenced in the Employer's Requirements.
 - (iv) The Contractors shall develop Earthing and Bonding Plans covering all the buildings and structures defining such provisions for the structures/ buildings.
 - (v) The design of OHE supports on bridges and their earthing shall be coordinated with CST Contractor.
- (f) In addition, the Contractor shall submit during this design stage the following:
- (i) The Design Submission Program in line with requirements of Chapter-4 of G.S. [Project Programme Requirements],
 - (ii) Validation of Data including Geotechnical Investigation and Drawings provided by the Engineer and additional Surveys required to be carried out by the Contractor,
 - (iii) A study of the Final Alignment Drawing for assessing the type and quantum of Traction Overhead work required and for planning the

supply of materials and execution of the work within the time frame finalized in accordance with the Coordinated Events and key milestones available for access to the site of Works,

- (iv) A study of Right of Way (ROW) for adequacy of land in the station yards, approaches and the land acquired for TSS and SSPs where traction installation are planned,
- (v) A proposal of the Work Areas outside e.g. proposed locations and design of Contractor's Temporary Works i.e. construction depots, plants, steel, fittings and other component stock pile areas, storage, workshops, camping areas etc. required to execute the Work according to the time frame,
- (vi) Main line and Station Yard OHE Layout Plans and their sectioning,
- (vii) General Arrangement of equipment at Traction Power Supply and Control Posts,
- (viii) OHE Joining and slewing plan for Indian Railways' adjoining tracks infringing location of Masts, if any and Connection with OHE of adjoining section,
- (ix) Design of OHE structures on bridges (Important and Major Bridges, and viaducts),
- (x) Design of OHE under over- line structures such as ROBs, Rail Flyovers, through girder bridges, Foot Over bridges etc.,
- (xi) Earthing and Bonding diagram for structures and metal work along the track & in vicinity including Indian Railways.
- (xii) Submit Method Statements covering the following:
 - a. Construction methods for installation of equipment and structures at TSS and SSPs including Earth mats and OHE,
 - b. Construction machinery and equipment to be used for foundation work, Mast erection, Bracket erection, Wiring, adjustments etc.,
 - c. Software's to be used for design activities,
 - d. Design Reviews including Checklists.
- (xiii) Two original sets of the full edition of the publication / technical standards including Codes & Standards and other documents that the Contractor proposes to use or used for the Work. An updated Design Submission Programme (as per – Chapter-4&6, Vol. 1 General Specifications);
- (xiv) Combined Services Drawings (CSD);
- (xv) The Traffic Management Plan for working of the OHE Construction/ work Train;
- (xvi) Proposed on site and off site testing arrangements for testing and quality control of input materials; and
- (xvii) Manufacture, Installation and Construction Methods;

- (xviii) Procurement Program for Manufactured Items;
- (xix) Proposal for physical progress report & basis for measuring the progress of the Work;
- (xx) List of technical documents, which Contractor proposes to prepare and submit to the Engineer for his approval;
- (xxi) RAMS specifications and studies expected during the Project to demonstrate the achievement of specified targets ;
- (xxii) SCADA study including system architecture;
- (xxiii) List and documents for the items/ equipment requiring cross acceptance criterion shall be submitted.

4.6.2 Detailed Design Stage

- (1) The detailed design of the Works shall be developed by the Contractor based on the approved Inception, traction simulation Report and approved Preliminary Design.
- (2) Submission during detailed Design may be divided into multiple submissions as per the Submission Program approved by the Engineer. In such a case, each submission shall include correlated and interdependent submittals so that each submittal is logically independent and consistent. The submissions at different stages shall be integrated and compiled into one package at the time when the final submission is made and the compiled documents and Drawings shall be submitted to the Engineer for issue of Notice of No Objection and will be collectively referred to as the detailed Design. Every design document shall be submitted along with the Design report, Supportive Calculations/ simulation results Extracts of reference standards used, drawings with legends and, Quantity Take-off sheets. Sub sheet(s) shall carry the master inset with clouding the relevant portion of the drawing in the sheet(s).
- (3) The detailed Design Submission shall be a coherent and complete set of documents, properly consolidated and indexed and shall fully describe the proposed Technical Design. In particular, and where appropriate, it shall define but not limited to :
 - (a) The dimensions of all major features, structural elements and members;
 - (b) All components and their specifications;
 - (c) Location, geometry and setting-out of all main elements and features;
 - (d) Provisions and proposals for construction interfacing with the other contractors and Interfacing parties; and
 - (e) Traffic Management for delivery of materials and execution of work.
 - (f) Submission of calculations on OHE related items as under but not limited to:
 - i. Calculation for adequacy of size of OHE structures selected for all types of typical OHE locations, Critical locations, Fixed Terminations, ATDs, overlaps, sharp curves and other Conductor support structures
 - ii. foundations
 - iii. Cantilever

- iv. Impact of temperature variation & climatic conditions
 - v. Conductor sag calculations
 - vi. Any other calculation as per EN50119 and as required by the Engineer.
- (g) submission of calculations on Power Supply Installations as under but not limited to:
- i. Calculation for adequacy of size of Battery system,
 - ii. power supply equipment,
 - iii. Overload, Short circuit, harmonics, voltage imbalance and Voltage drop, Power factor, losses
 - iv. equipment & component support structures,
 - v. Bus bar system,
 - vi. Earthing system, step & touch potential rise
 - vii. Lightning Protection system etc.
 - viii. Any other calculation as required by the Engineer
- (4) The Contractor shall not, without the prior written consent of the Engineer:
- (a) Revise or alter the content of any document and / or Drawings in the design package which have been submitted to and approved by the Engineer. The Technical design shall be developed based upon the previous submission(s) unless otherwise the Engineer approves the change in the contents. Every revision of Drawing/ document shall have a unique revision number, revision date including that of the reference drawing/ document referred therein for establishing the traceability.
 - (b) Reduce the periods provided for review by the Engineer of any submission of design, design data and materials as set out in the Design Submission Programme;
 - (c) Revise the sequence of submissions of design, design data and material as shown in the Design Submission Programme.
- (5) Detailed Drawings and Documents
- The Drawings shall be a set of Drawings which describe integral feature of the Permanent Works strictly in compliance with the Employer's Requirements including, general arrangements, and layouts of structures, all materials with associated fittings, all machinery and equipment with associated fittings and Drawings which supplement the above. The Contractor shall submit including but not limited to the following Drawings:
- (a) OHE**
 - (i) The OHE layout of the Traction Overhead equipment on the Final Alignment Plan of main line and the yard plans, including but not limited to offsets from the parallel IR tracks;
 - (ii) OHE profile Drawings through Over-line structures, bridges & viaducts;

- (iii) General arrangement, location plan, geometry, and setting out Drawings;
- (iv) The Cross Section Alignment Drawings at all OHE structures;
- (v) The Structural Drawings for Masts and Portals for OHE and Switchyards of Traction Supply Posts.;
- (vi) Earthing and Bonding Plans;
- (vii) OHE Sectioning Diagrams of main lines and yards;
- (viii) Details of connections with Indian Railways and adjoining DFCCIL sections including the details of sectioning and traction control switching;
- (ix) OHE Structural Steel–masts and portal structures for support of the Overhead Conductor(Head spans shall not be used except at locations where the Contractor has received written permission from the Engineer);
- (x) Small part steelwork Fabrications – galvanized small part steelwork (SPS) assemblies required to support OHE, some of which may be special structural assemblies;
- (xi) Foundation Layout of Structures and Equipment;
- (xii) Cross section drawings and SED drawings.

(b) Traction Power Supply System

- (i) Cross section, Elevations Drawings, General arrangement and Equipment Layout plan of TSS, SSP, ATS (if any)and other installations;
- (ii) Level & filling cross section Drawings of TSS & SSP;
- (iii) Incoming EHV transmission lines termination Gantry at TSS
- (iv) Gantry for 25kV AT outgoing feeder to the OHE;
- (v) Architectural Control Room layout of TSS and SSP and at ATS (if any);
- (vi) Layout of Earthing system;
- (vii) Lightning Protection System at TSS and SSP;
- (viii) Fencing Layout;
- (ix) Typical Equipment Layout of Control Room Building for TSS and SSP;
- (x) Cable trenches layout along with cross section;
- (xi) Drainage of TSS Yard including that for Cable trenches (Control and containment of oil spills should be kept in view during design of the transformer bay(s));
- (xii) Outdoor yard layout, Bus bar supports;
- (xiii) Outdoor yard Illumination Lay Out;
- (xiv) Clearance Drawings of outdoor equipment, bus bars and conductors;

- (xv) Cable Run Layout;
- (xvi) Combined service drawings;
- (xvii) Battery and battery charger details;
- (xviii) Connection of TSS/ SSP to Adjacent Track;
- (xix) Switch Yard Slope and Drainage Drawings;
- (xx) Soil Bearing Capacity and Soil Resistivity;
- (xxi) Fencing drawing;
- (xxii) Gantry arrangement drawing.

(6) **Detailed Design Report**

- (a) The Detailed Design report shall be of narrative type describing the detailed Design Submission including its Title, executive summary, Purpose, assumptions, Input Data, Step wise Calculations with reference of the Formula used, Reference standard with Para/ clause number, Summary of output results and relationship with other submissions/ reference. It shall include, a guide to all relevant technical data used and outline the design approach, standards used, design calculations & analysis particularly in respect of Traction Power Supply, OHE Components and arrangement, OHE sectioning, the protection scheme and the interlocking provided for a safe and reliable traction system. The design Report shall specify the limitations for the second failure situations as a part of the reliability study.
- (b) Structural analysis report including loading diagram and input & output files of the approved software used for the design of traction structures.
- (c) For traction Power Supply System complete design document in respect of all the systems, equipment/ components viz. earthing, HT/LT panels, interlocking arrangements, cabling layout, internal wiring, conduiting, and general electrification works as per Vol-5 Particular Specifications for E&M and associated Work.
- (d) The report shall also include design submissions, EMI Mitigation/ EMC control and earthing & bonding plans for approval by the Engineer so as to ensure appropriate execution by contractor of these safety works, the completion of which is a necessary pre-requisite for completion of the project.

4.6.3 Construction/Installation Design & Drawings

Based on the approved Detailed Designs, The Contractor shall develop the construction/ Installation designs and Construction Reference Drawings (CRD) for implementation at site as specifically required for each location.

- (1) It shall have the reference of the approved detailed design/ drawing, Method statement, safety & quality check guidelines and Special Gadgets required for the execution.
- (2) It should contain all the information as required for Detailed Interface requirements.
- (3) It should contain all the information as required for the Execution and Checking.

4.6.4 As-Built Documents

The Contractor shall produce the '**As Built drawings**' for the work executed **but not limited to the list of drawings identified in para 4.6.2** including the following

- (1) Dated Records of Measurements and Records of Test results;
- (2) Dated Evidences of execution i.e.
 - a. Monthly Progress Photographs& Videos of all the activities of work executed,
 - b. Progress Photographs of hidden work before covering/concealing.
- (3) Execution Report etc.

(End of Chapter 4)

CHAPTER 5 - PERFORMANCE REQUIREMENTS FOR TRACTION POWER SUPPLY SYSTEM

5.1 GENERAL

5.1.1 One Traction Sub-station is proposed for the Dadri - Khurja section, located at Wair (IR Km: 1390.90). The Wair TSS shall be capable to feed Dadri – Khurja section including upto the SPs (Neutral Section) of adjacent sections under normal feed condition as depicted in Fig.501 and also detailed here under :

- (1) On the Khurja end, upto Danwar SP of the New Bhaupur - Khurja Section (CP-104),
- (2) On the Dadri end, upto Dadri Jn SP of WDFC (CTP-14) ;
- (3) upto Khurja RFO SP of Khurja – Pilkhani Section (CP-305),

5.1.2 Dadri - Khurja being the terminating section of the double line EDFC, its traction power supply system shall be capable of meeting the projected demand of the train services with the Wair TSS equipped to deal with the exigencies due to outage of the adjacent Ibrahimpur TSS of the New Bhaupur - Khurja Section (CP-104),.

5.1.3 For the purpose of Power supply security, redundant double circuit 132 kV Power supply has been planned to be tapped from IR's 132 KV transmission line network for the Wair TSS. The indicative typical TSS conceptual Scheme Diagram and layout is attached vide reference drawing no. GC/DFCC/PS/TSS/SCH/TYP/101 in Part-4: 'Reference Documents'.

- (1) The TSS shall be equipped with Transformers with Spare/standby Capacity and in numbers as required along with associated switchgears. The TSS shall be able to supply full power even in case of failure of any equipment or a set of Bay Equipment or bay is out of Service or under failure/ maintenance through other Equipment / bay In case of availability of any one incomer 132kVsupply up to transformer terminals (while other Circuit could be in failure/ maintenance) the TSS shall be able to supply power to OHE through CRISS-CROSS redundancy even if one transformer or one equipment of any bay is failed or under maintenance or not available for use.
- (2) Subject to Engineer's approval, the Contractor shall be allowed to do a value addition and can make own layout arrangement within the space allocated without reduction in flexibility available in existing arrangement or any compromise in performance.

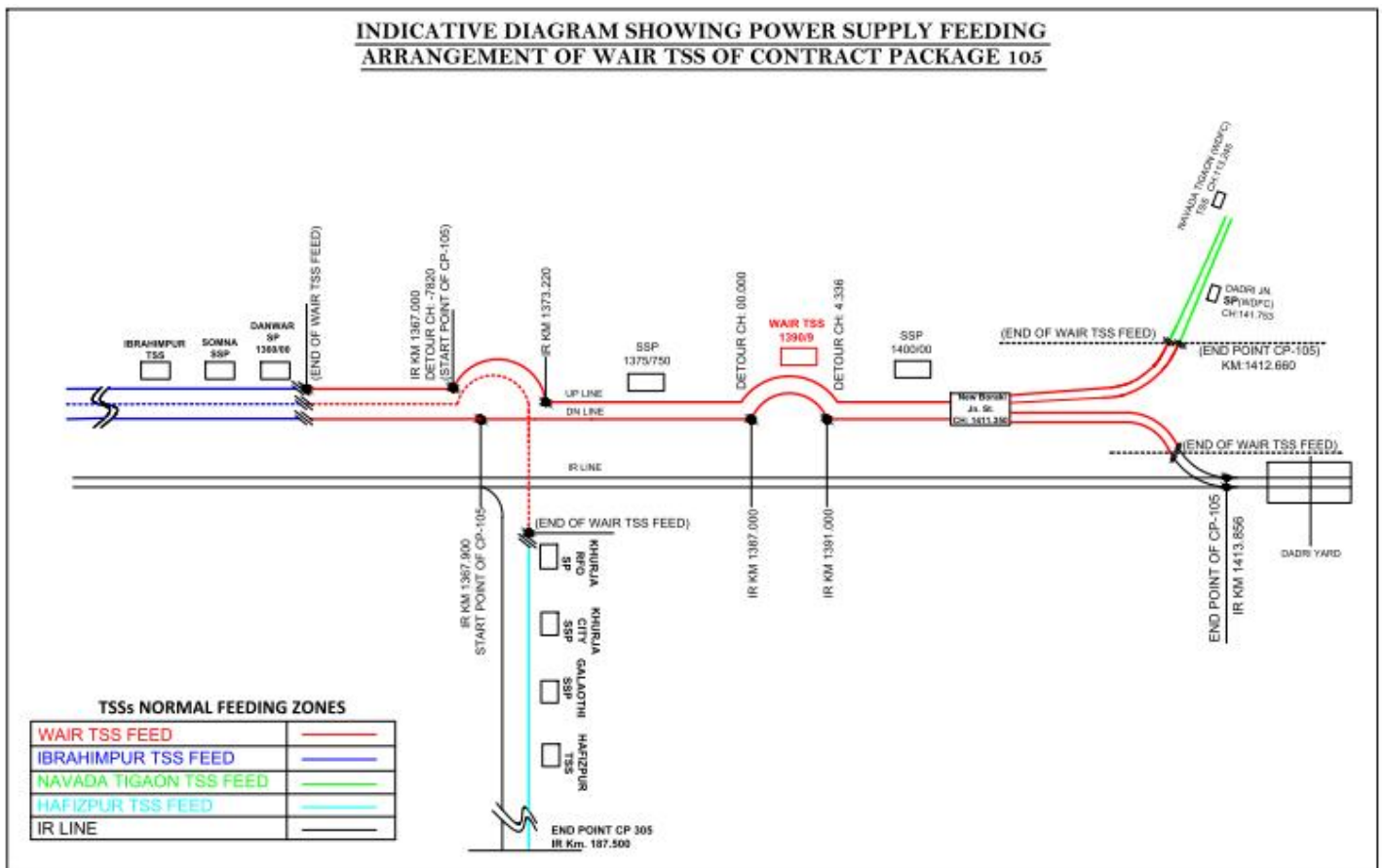

Figure No. 501

5.1.4 **Normal feeding Scenario**

‘Normal Feeding Scenario’ is defined as “all traction equipment in service, the TSS supplying power up to the neutral sections of the adjacent SPs as well as the conditions as listed below:

1. **132kV Bay Normal Scenario**

- (a) Both the incomers are available. 132kV Bus coupler Circuit Breaker (CB) in open condition. Only one of the 132kV Incomer bay is taken on load. Both the 132kV incomers are independently rated to take full load of the TSS.
- (b) In case, One of the incomer supply is not available or any 132 kV bay equipment are under fault/ maintenance, the Power supply shall be available through healthy 132kV bay through remotely closed 132 kV bus coupler CB to the Transformer Bay.

2. **Transformer Bay**

TSS with Main and Spare transformer

- i. The Traction Transformer(s) are healthy along with 132kV HV and LV (54/2x25kV) side switchgears and protection CT.
- ii. If one of the Traction Transformer or Transformer bay equipment is not available due to fault/maintenance or non-provision, the Traction Load shall be serviced by the available spare/standby Transformer(s) or transformer(s) Bay without any impact on train operation

performance. The switching over of loads between Transformer(s) shall be resorted to, for better life of transformer(s). Employer may choose to keep other spare/ standby transformer in charged and offloaded condition for short/ long time before switching over of load in line with philosophy adopted on Indian Railways.

3. 54kV/2x25kV Bus Bar:

Bus Bar shall be sectionalised with Bus coupler normally closed. In case of Half Bus out of service due to maintenance/ fault, the Power supply shall be routed through the other healthy half of the bus.

4. Feeding bays:

- (a) Each bay feeds the respective UP/DN and right/ left side of OHE system.
- (b) In case of failure of one of the bays of UP or DN lines, the other bay of DN or UP line takes care to supply the Right/ Left side of the power supply control post.
- (c) Redundant capacity of all equipment of the bays shall be built in for the purpose of reliability.
- (d) The bays, which are provided with ATs, shall be suitably designed to allow the availability of supply through alternate route in case of failure. The capacity of ATs shall be suitably upsized with such consideration.

5.1.5 **Emergency Feeding Scenario** is defined as “**A first failure condition (N-1)**” that either:-

- (1) The adjacent TSS (Ibrahimpur in the New Bhaupur - Khurja Section CP-104), is out of service, the feed is extended from the healthy TSS (Wair) till the Outage TSS Neutral section (Ibrahimpur TSS).
- (2) Feed extension requires the Bridging circuit breakers to be closed at the adjoining (Danwar) SP and the supply from the healthy, i.e Wair TSS is extended up to Neutral section of adjacent Outage TSS (Ibrahimpur).
- (3) May require the bypass coupling interrupter to be closed between the Up and Dn lines and a supply to be extended for both lines from one feeder circuit breaker as far as the adjacent SP.
- (4) And the isolation of a single auto transformer, if any in the section.

5.1.6 Under all emergency feeding conditions; full designed headway service shall be feasible without any loss of performance.

5.1.7 **First failure conditions (N-1) performance requirement** –Traction power supply system shall be capable of meeting the projected demand of the services. The Wair TSS shall be designed to deal with exigencies from one adjacent TSS (Ibrahimpur) going out of service, to facilitate extension of feed up to Neutral section of the Ibrahimpur TSS. Under first failure condition (N-1), full design headway/ train service shall be maintained without any loss of performance.

The contractor shall also identify and describe the conditions of all Single point Failure at the adjacent TSS (Ibrahimpur) and the SSP and assess & quantify the impact with requirement of Power rerouting and the energy requirement in KWh and MVA peak load.

- (1) All the equipment shall be sized considering the single point failure at the location

and one TSS failure with required safety margins (in rating) to meet the application duty requirement of the most stringent power requirement without affecting the power quality.

- (2) The adjacent TSS (Ibrahimpur) outage may persist continuously for a number of days until the defective equipment is replaced. The Single point Failure and the adjacent TSS outage shall not use the overloading capacity of the equipment at Wair TSS, as prescribed by standards.
- (3) The Traction Transformer (s) at the Wair TSS shall be rated for full capacity to meet the power requirement of the extended feed scenario.

5.1.8 **Second failure conditions (N-2) performance requirement**– Under second failure conditions, including failure of two consecutive Traction Substations viz. Ibrahimpur TSS and Biruni TSS of the adjoining New Bhaupur - Khurja Section, the traction power supply system of CP-105 section shall be designed to allow for a reduced train service. The Scenario may consider extended headway/ reduced speed of trains to operate in the affected section. The TSS equipment sizing for second Failure condition (N-2) shall be supported by multi train simulation study. This shall have to be approved by Engineer and provision should exist with the operator to choose a combination of above or anyone of the above extended headway or reduced speed.

5.2 ROLLING STOCK CHARACTERISTICS AND TRAIN OPERATION DATA

5.2.1 Traction power supply for Dadri – Khurja section of Eastern Dedicated Freight Corridor shall be designed taking into consideration the rolling stock characteristics and train operation data given below in Table 5.2.1 and Table 5.2.2. The Tractive effort Vs Speed Characteristic of 12000HP locomotives to be utilised on EDFC shall be as included in the reference document of Part–4. The following data shall be used for all normal and emergency performance requirements of traction power supply system.

Table 5.2.1: Rolling stock characteristics **

Item	Values
Maximum operating speed	100 km/h
Maximum test speed	100 + 10 %km/h
Adhesion	40% Starting (Indicative)/ 30 % Continuous
Locomotive weight	Weight 180 tonnes ± 1%; upgradable to 200 tonnes + 1%.
Starting Tractive effort (up to speed not less than 10 kmph)	Not less than 785 kN for 25 T axle load
Continuous rated power at rail	Not less than 9000 KW at all speeds from continuous speed (60 kmph) to max operating speed
Type of rolling stock	Bo-Bo+Bo-Bo, 8 axle Locomotive hauling BOXN and bulk wagons.
Type of Braking	Electrically controlled-pneumatic service friction brake, Electric regenerative brake for the loco
Pneumatic brake effort	7 % - 9 % of gross weight

Item	Values
Emergency braking distance (with pneumatic brake only)	900 m maximum for light engine from 100 Km/h to standstill on level tangent dry track
Efficiency of propulsion system	Not less than 87% at full load
Auxiliary Power requirement of Locomotive	300kVA

**Ref: RDSO specifications no. RDSO/2006/EL/SPEC/0044 Rev. '13' of June 2013 for 12000 hp locomotive.

5.2.2 These characteristics are as per RDSO Specifications and are subject to confirmation from IR. Further details such as power drawn, harmonics and various time and distance characteristics for Level of services at design headway shall be ascertained from IR.

Table 5.2.2: Train Operation plan

Train Consist	Headway/ frequency
1. 1 x 9000kW / 12000 HP electric locomotive plus 63 BOXN wagons (100T each) with single 'train consist' of 6500 T (All trains in UP direction shall be fully loaded). 2. In DN direction 30% trains shall be fully loaded (6500T) and 70 % Trains shall be Empty Trains (1650T). 3. A mix of Single Train and Double train in the ratio of 2:1 shall be considered for both UP & DN directions. 4. The double train Consist shall have two single trains coupled with Electric locomotives in Front and middle.	Headway 13 Min

Note: The trains in the Initial period will be generally hauled by WAG-5, WAG-7 and WAG-9 and 9000 HP locos of Indian Railways.

5.3 VOLTAGE REQUIREMENTS

5.3.1 Traction power supply system for Dadri - Khurja section of Eastern Dedicated Freight Corridor shall meet the requirements given below in Table 5.3 in respect of maximum and minimum voltages at any overhead current collection point.

Table 5.3 Voltage Requirements (as per EN50163)

Item	Values
Nominal voltage	25 kV A.C.
Minimum Voltage	19 kV A.C.
Maximum Voltage	27.5 kV A.C.
Lowest Non – permanent Voltage	17.5 kV A.C.
Highest Non - permanent Voltage	29 kV A.C.

5.3.2 The requirement of voltage and frequency shall meet the requirements given in EN 50163.

5.4 PERFORMANCE FEATURES

The reliability of the systems designed, supplied and installed is the principal element for availability. It is essential that the System reliability is as high as reasonably practicable.

5.5 SYSTEM REQUIREMENTS

5.5.1 Train Operations

The system shall be designed to fully satisfy the operational requirement as per the "Train Operation Plan" given in table 5.2.2.

The train resistance and locomotive resistance data as followed by IR is given below:

- (1) Train resistance (of BOX N wagon excluding Locomotive)
 - (a) Main Line starting resistance on level tangent track (including acceleration reserve) = 4.0 (in kg/tonne)
 - (b) Main Line running resistance on level tangent track = $0.6438797 + 0.01047218 V + 0.00007323 V^2$ (in kg/tonne), where V is speed in Kmph
- (2) Grade resistance = $1/G \times 1000$ (in kg/Tonne), where G is gradient (e.g. G =200 in case of 1 in 200 gradient)
- (3) Curvature resistance = $0.4 \times$ curvature in degree (in kg/tonne)
- (4) Locomotive resistance
 - (a) Starting resistance on level tangent track = 6.0 (in kg/tonne)
 - (b) Running resistance on level tangent track = $0.647 + 13.17/W + 0.00933V + 0.057/WN \times V^2$ (in kg/tonne)

Where W = Axle load of the locomotive in tonne

N= Number of Axle

V = Speed in km/ph

- (5) The Automatic Signals is being proposed for New Khurja -New Boraki section and Absolute Block signaling for New Boraki – Dadri section.
- (6) In case of failure of two consecutive Traction Substations viz. Ibrahimpur TSS and Biruni TSS (N-2 Scenario), of the adjoining New Bhaupur - Khurja Section, the traction system (by extending the feed from the healthy Wair TSS towards the affected section, till Dariyapur SP of the Biruni TSS i.e. 90km sections from healthy TSS) shall permit Train operation with reduced services (no. of Trains) in the extended feed zone of 90km.
- (7) For failure of adjacent Ibrahimpur TSS, the system shall be able to support 100% train service under normal and emergency feeding conditions as per Train Operation Plan. For failure of consecutive TSSs, reduction of train service shall be acceptable. The regeneration figure shall be considered zero for simulation purpose. For Traction Power Simulation, consider stoppage of trains at alternate stations, maximum dwell time of 3 minutes and wind speed of 0.5 m/s and Power factor of 0.95. For DN direction, worst case scenario of sequence of trains as per the Train operation plan, shall be considered for simulation.

5.5.2 System Wide EMI Mitigation / EMC, Earthing and Bonding strategy

- (1) Based on the simulation studies, the Contractor shall develop an EMI Mitigation/ EMC strategy and Earthing & Bonding scheme for the entire system to ensure safe touch & step potentials for the traction installations and those of track and metal work of other installations of Dadri - Khurja section of Eastern DFCC. This

strategy shall also include installations of other parties affected by the traction currents. The strategy shall be developed in the work execution design for incorporation in the Traction System Installations of track, bridges, viaducts and other adjacent metallic structures, protective works for electrical circuits, signal and telecom installations including similar works required for the adjacent Indian Railway route running parallel to the DFC and also include any installation of other parties which may be affected. All the works as designed shall also be executed.

- (2) The Contractor shall ensure that step and touch potentials do not exceed the voltage limits as stipulated in EN 50122-1 during failure of Overhead equipment, snapping of conductor, Insulator leakage and locomotive fault exceeding duration of 300 ms, as minimum, subject to back up protection clearing the fault within this period to be confirmed by the contractor which, shall be demonstrated through design calculations.
- (3) The Contractor shall simulate the worst condition scenario including the failure of insulator, Rail fracture, earthing of broken conductors etc. as per EN50122-1.

(End of Chapter 5)

CHAPTER 6 - DESIGN CRITERIA & PERFORMANCE SPECIFICATIONS FOR TRACTION POWER SUPPLY SYSTEM

6.1 CONCEPTUAL POWER SUPPLY ARRANGEMENT

6.1.1 Conceptual schematic power supply arrangement diagrams of typical TSS/SSP are furnished in the reference Drawings (Part 4). Based on the conceptual schematic Drawings, the Contractor may review, improve layouts/ arrangements to effect space saving.

6.1.2 All Civil, General Power Supply and E&M works as described in Vol-5 Particular Specification (PS) for E & M and associated works shall be provided by the Contractor.

6.1.3 Traction Substation (TSS)

- (1) The Power for Dadri - Khurja section of EDFC will be tapped from Indian Railways owned 132kV, 3 phase, double circuit transmission line network, by way of Loop In Loop Out arrangement for the Traction Substation (TSS). TSS equipment and Bus bars shall be suitably designed and capable to feed the extended feed zone as per application duty requirement.
- (2) The TSS shall be provided with equipment/ functionalities as below and as per the typical indicative schematic included in Part 4 Reference Documents, but not limited to provision of:
 - (a) Incoming Bays for double circuit 132kV at TSS, the Gantry and Overhead cross feeders including terminations and insulation. Incomer bays shall have isolators with bus coupler 132kV Circuit Breaker (CB) arrangement for quick switchover of power from one 132 kV bay to the other 132kV bay.
 - (b) Incomer metering Bays with Check meters, Metering CT, PT and the associated insulation, protection and Monitoring arrangement, as per IR / PGCIL specifications with required communication ports, on the 132kV incoming side in a separate cubicle at the TSS, which should have communication with OCC through SCADA.
 - (c) Provision of LILO arrangement along with associated switchgears as detailed hereunder;
 - i. 132kV Incomer Isolators with / without earthing heels;
 - ii. 132kV Bus bar arrangement ;
 - iii. 132kV 3 Pole incoming Circuit Breaker ;
 - iv. 132 kV Isolators
 - v. 132kV Bus-Section including 132kV AC 3 pole Circuit Breaker with Manual Isolator.
 - (d) 132kV – Protection Current Transformers , Potential transformers
 - (e) 132kV, AC Triple pole Circuit Breakers,
 - (f) 132kV AC/ 54 or 2x25 kV Traction Transformer(s) complete with all accessories;
 - (g) Circuit Breakers suitable for 2x25kV AT feeding System

- (h) Bridging interrupters suitable for 2x25kV AT feeding system;
- (i) Isolators, suitable for 2X25 KV AT feeding system;
- (j) Lightning arrestors for 132 kV, 54kV and 2X25 KV AT feeding system as required;
- (k) 54/2x25 kV & 25kV Rigid Bus bar arrangement along with required insulation and isolation and 100% redundancy
- (l) Bus Coupler CBs
- (m) Auto transformers (as required by design);
- (n) Auxiliary transformers 100kVA and 10kVA for 25 kV/240V single phase supply at TSS;
- (o) Single core and multi core copper Conductor, XLPE insulated cables(for 220/132kV, 25kV and control Cables as required) ;
- (p) Return current circuit cabling (**minimum 3.3kV, single core**)and bonding for the tracks in close coordination with Other Contractors/Agencies; Earthing and Bonding system including Buried Rail for efficient Traction return current;
- (q) Control & Protection system comprising of Protection relays, Control Relay panel and CTs / PTs
- (r) Batteries and Battery Chargers;
- (s) Power quality improvement equipment to keep harmonics and voltage unbalance within the specified limits at rated Capacity;
- (t) Power Factor Improvement Device to improve power factor up to 0.95 or as specified.
- (u) Fault locator
- (v) RTU and control equipment

6.1.4 Sub Sectioning and Paralleling Posts (SSPs)

Sub-Sectioning Posts for 2X25 KV AT systems and as per the indicative schematic included in Part-4 'Reference documents', in the section includes, but not limited to provision of:

- (1) Circuit Breakers for 2X25 AT system with Protection relays as required to automatically isolate faulty section/ equipment, Control Relay Panel and CTs, PTs as per application duty of Max. 60kV or Max. 30 kV rated voltage, and suitable BIL in conformance to EN50124-1;
- (2) Interrupters for 2X25 AT system;
- (3) Isolators for 2X25 AT feeding system;
- (4) 54 kV Auto Transformers;
- (5) 10 kVA, 25kV/240V, single phase Auxiliary Transformers;
- (6) Single core and multi core Conductor, XLPE insulated cables;
- (7) Return Current Circuit Cabling;
- (8) Earthing and bonding system;

- (9) Batteries and Chargers;
- (10) Lightning Arrestors;
- (11) Fault locator
- (12) RTU and control equipment

6.1.5 Auto Transformer Station (ATS), if any provided:

It shall include, but not limited to the provision of:

- (1) 25 KV isolators, (motorised),
- (2) Auto Transformers,
- (3) Auxiliary Transformers (10 KVA),
- (4) Single core and multi-core copper cables,
- (5) Return Current circuit cabling,
- (6) Track Bonding system,
- (7) Protection CTs,
- (8) Batteries and chargers,
- (9) RTU and control equipment,
- (10) Automatic Fault Locator (as per design).

6.2 DESIGN OF THE POWER SUPPLY SYSTEM

6.2.1 The Contractor shall propose to the Engineer proven multi train system simulation software to be used taking in account the data for rolling stock, train loads, driving pattern speeds, stoppage, track alignment, curve and the Scheme of Electric Traction System as stipulated in clause nos. 3.2 of this specifications. The Contractor shall propose the various simulation runs to be undertaken to confirm system performance parameters and the equipment sizing, for Engineer's approval.

6.2.2 This Simulation study shall also be used to determine the sizes & rating of 132kV, 2x25KV and 25kV Traction equipment such as Traction Transformers, Auto Transformers, circuit breakers, Interrupters, isolators, 132kV Flexible and 54 & 25kV Rigid bus bar as required for TSS & SSPs taking into account, Thermo-dynamic stresses as per the application duty requirement and Emergency feeding scenario of First Failure N-1 and N-2 Failures as defined in this PS including Touch & Step potentials under fault conditions. The rating of the Auto transformers shall be same for SSP and TSS as required as per design.

6.2.3 The Simulation software shall produce output as a minimum for the following, both during normal feed i.e. all TSSs (including those in the adjoining section) in service and during Extended feed i.e. one TSS(in the adjoining section) out of service:-

- (1) Voltage profile at pantograph of each train simulated under normal & worst condition;
- (2) Capacity of Traction Transformer;
- (3) Current output of the TSS, both Peak and RMS current
- (4) Capacity of Auto-Transformers and requirement of Stand-alone ATs (if any) considering One AT failure in associated traction Cell of TSS-SSP;

- (5) Load Flow study and Short Circuit study to identify the Current carrying Capacity and short circuit withstand Capacity of each circuit breaker or interrupter, Bus bars and TSS/SSP equipment including current at all node points;
 - (6) Touch and step potentials of Traction Rail, interval of grounding of earth wire (AEW) and Buried Earth Conductors (BEC) as required, to connect rails either directly or through impedance bonds.
 - (7) Voltage Imbalance / Fluctuation and Harmonic Distortion
 - (8) EMI/EMC study
- 6.2.4 Anticipated short circuit levels are given in Table 6.5.1. Based on the traction power system requirements and load flow & Short Circuit Traction power Simulation studies, the Traction power supply system shall be designed. Sizes and ratings of all equipment, cables of different voltages 132kV, 25kV A.C. and 240V A.C. auxiliary supply, earth bus and conductors, joints, jumpers, as well as ancillary equipment and instrument transformers shall be finalised. All the equipment and bus bars shall be designed to withstand the thermodynamic stresses caused by the stringent Short circuit fault scenario the system may witness.
- 6.2.5 The details of calculations and specifications finalised shall be submitted to Engineer for approval.
- 6.2.6 The multi-train simulation study shall be used to verify the capacity of traction substation, Sub-sectioning and Paralleling Posts and standalone AT stations (if required) and evolve design to meet the traction power demand and voltage requirements for train operation Plan and application duty requirements satisfactorily for all power scenarios identified in relevant chapters and as under but not limited to;
- (1) Normal feed conditions and Extended feed conditions with one adjacent TSS(in CP-104 section) out of Service;
 - (2) Normal Feed condition with Single point failure scenario either One source /feeder of 132kV Bay out of Service or One of the 54 kV Bus bar or Half bus bar out of Service;
 - (3) If One line feeder breaker fails,(supply shall be routed through other bay by closing the paralleling CB/interrupter to ensure availability of power with single point failure)
 - (4) To specify the optimum interval between rails to earth connections to ensure that the rail voltages are within permissible limits as per IEC 62128/EN 50122/ EN50522.
 - (5) Max power demand in case of extended feed condition and minimum voltage at pantograph under worst condition;
 - (6) Failure of Capacitor bank;
 - (7) Failure of Power quality equipment at TSS;
 - (8) One AT failure at TSS (as applicable) or SSP.
- 6.2.7 This specification gives indicative details of power supply arrangements envisaged for traction power supply system for the Dadri - Khurja section. The Contractor shall examine the entire scope of work and scrutinize the specified system, the specifications of cables and equipment and work out the ratings based on his own designs of the entire system without compromising the redundancy and reliability, availability and

Maintainability.

- 6.2.8 Fire detection and Protection system including Fire walls and Barriers as conforming to international standards NFPA 221 and 851 at TSS and SSP shall be provided to protect against the fire risk.
- 6.2.9 Insulation level of the equipment selected shall be in conformance with EN50124-1 and IEC 60071-1 at TSS and SSPs.
- 6.2.10 Automatic Fault Locators at TSS and SSPs, with accuracy within ± 450 metre (3% of average inter distance between TSS-SSP), shall be provided.
- 6.2.11 The Power supply system shall be monitored and controlled through a SCADA system installed at a Centralised Operation & Control Centre and associated Control, monitoring & sensing equipment at TSS and SSP including the equipment level Fault Diagnostic as required.

6.3 DESIGN OF EARTH SYSTEM

- (1) System protective earthing for providing electrical safety on entire system including earthing of non-current carrying metallic components, cable supports, transformer neutrals, lightning arrestors, etc. shall be designed. The earthing system shall conform to IEEE80: 2013, EN 50122-1 and EN – 50522, IS 3043 – 1987, and Earthing Manual 311 Issued by CBIP in that order of priority as applicable.
- (2) The earth system shall consist of: -
- (a) Earth Mats and Earthing Systems in Traction Substations,
 - (b) Earth Mat System in Sub-Sectioning and paralleling Posts,
 - (c) Earth Mat System in Sectioning and paralleling Posts,
 - (d) Earth Mat Systems at Auto Transformer Stations (if any),
 - (e) Buried earth conductors (BEC), as required, of appropriate size along the track alignment as per the scheme shown in Part-4 Reference Documents,
 - (f) Isolators with earthing heels as required,
 - (g) Earth for Auxiliary Transformers,
 - (h) Buried rail and its connection,
 - (i) Earthing of Neutral section,
 - (j) Aerial Earth Wire (AEW) of appropriate size along the track alignment as per the scheme shown in Part-4 Reference Documents,
 - (k) Structure Bond & Rail Continuity and Cross Bonding where required,
 - (l) Bonding and earthing, equipment earthing and working platforms to limit the step and touch potential of Equipment's working platform,
 - (m) Earthing of bridges, Station Canopy, Service Building in proximity and Track side structure in conformance to EN50122-1,
 - (n) Independent earthing/ satellite earth mat to limit the step and touch potential.
- (3) The Contractor shall carry design study of the earthing system on the basis of safety to public, the operator and maintenance personnel against touch and step

potential & fire hazards and finalise the design, sizes and layout of main earth conductors, taking into account of adjacent 25kV system also.

- (4) In all traction power supply control posts, MS rods, GI flats and pipes, allowing adequate margin against corrosion shall be used as per EN-50522 / IS 3043 in that order of priority as applicable and manual on sub stations issued by Central Board of Irrigation and Power. The earth rods below the mat shall be copper clad steel as per IEEE80/IEC62561-2/ANSI/NIMA Gr-1-2007/EN50522-2. All the Earth mat joints shall be exothermic as per the requirements of IEEE80:2013. The connections shall be maintenance free, self-gripping type. Wherever the earthing bonds pass along or across the tracks, it shall be routed along the sleepers using proper fasteners and clamps so as to avoid damages/ disconnection during ballast screening or tie-tamping of the track.
- (5) The Earthing system provided at TSS and SSP shall include Earth Mat system designed in conformance to IEEE 80: 2013. The maximum earth resistance of entire System shall meet the following requirements:

Table 6.3.1 Maximum Earth Resistance

Location	Total earth system resistance (OHMS)
TSS	0.5
SSP	0.5
Other locations	To meet the requirements of EN50122-1

6.4 LIGHTNING ARRESTERS

- 6.4.1 Lightning arresters shall be installed at each location of TSS, SSP and ATS (if any). All auxiliary transformers shall have provision of spark gap as per RDSO's latest instructions.
- 6.4.2 Each lightning arrester shall incorporate an individual earth, which shall be connected to a ground rod or rods and shall also be connected to the earth system in vicinity.
- 6.4.3 Each earth connection shall have earth resistance as specified by the lightning arrester manufacturer for the type of unit supplied, and shall be tested individually in accordance with testing procedures as approved by the Engineer.
- 6.4.4 Bonding cable connections between the Lightning arresters and the OHE, and between the Lightning arrester and the grounding system, shall be installed with a minimum number of bends.
- 6.4.5 The connection of lightning arresters to OHE shall be such that in case of breakage of the lightning arrester, the connector does not create an earth fault in the OHE.
- 6.4.6 Lightning arrestors shall be provided with leakage current monitor and surge counters for monitoring.

6.4.7 Lightning Protection

- (1) The entire sub-station shall be protected against lightning strikes by providing earth screen conductors on tower peaks and/or by means of lightning protection masts suitably spaced to cover the entire area.
- (2) The height and locations of the lightning masts shall be designed appropriately with due consideration to the equipment layout in the TSS, to ensure that all the equipment required to be protected against lightning are within protective zone

provided by the lightning conductor.

- (3) The lightning conductor shall consist of ;
 - (a) Lightning receiver projecting above the object to be protected;
 - (b) The earthing grid;
 - (c) The conductor which connects the receiver with the earthing grid and is meant to carry the lightning current away safely to the ground.
- (4) The contractor shall furnish a calculation for the Direct Stroke Lightning Protection system for TSS/SSP and ensure that all the equipment remain protected from Direct Stroke lightning the lightning protection designs shall provide a failsafe protection to the TSS building and switchyard.
- (5) Lightning protection shall conform to IEEE 998, IEC 62305 and IEC 62561 as applicable.

6.5 SHORT CIRCUIT CAPACITY

The Contractor shall ensure that traction substation and auxiliary power supply system including cables installed, shall be capable of withstanding the IR transmission network fault levels at the points of common coupling and downstream with an allowance to cater for possible future increases. The Short Circuit levels shall be 10000MVA for 132kV supply conforming to EN 60076-5 (table-2), IEEE-StdC37.010. The fault levels to be catered for are given in Table-6.5.1 below. Specific requirements (wherever they are different) are furnished in the equipment/sub-system specifications. The Contractor shall carryout the load flow and short circuit study of the 2x25kV distribution network and adopt the short Circuit level as stringent which may be witnessed in any stringent fault Scenario. Nevertheless the Fault level at OHE shall not be taken less than 12kA for calculations.

Table 6.5.1: Design Short Circuit Levels

System Voltage (kV)	Breaking Capacity/ Apparent Power in MVA	Fault Duration in Seconds
132	10000	1

6.6 EHV POWER SUPPLY DESIGN DATA

6.6.1 Insulation Coordination

- (1) The nominal voltages and corresponding maximum voltages shall be as follows:-

Nominal Voltage	Maximum Voltage
132kV	145kV
25kV	29kV
240V	250V

- (2) The 132kV ac and 240V equipment shall meet the Insulation coordination requirements of EN50124-1 or IS 2165 (Part I and Part II) with latest amendments as stringent.
- (3) 25kV ac equipment shall have Insulation levels according to the EN 50124, Railway Applications – Insulation co-ordination.

- (4) 2x25kV switchgears where they are the supply Phases are 180 Degree apart the rated voltage will be minimum 60kV.

6.7 POWER QUALITY

6.7.1 Contractor shall ensure the Power Quality keeping the voltage and current unbalance, reactive power and harmonic contents within the prescribed limit of State utility / PGCIL in normal and extended feed conditions throughout the designed life of the equipment. For connectivity to the grid sub-station of power supply authorities, following power quality limits have been laid down at the point of common coupling (PCC), the contractor shall Control the Power quality within the applicable limits by providing the necessary PQ Improvement equipment.

6.7.2 Voltage unbalance

The limit of voltage unbalance permitted according to Central Electricity Authority (CEA) standards for 132 KV supply, is 3%.

6.7.3 Harmonics Generated at the PCC-132kV

The contractor shall carryout the Harmonic Study and Provide the Mitigation equipment to limit the Harmonics within prescribed limits as per guidelines issued by Central Electricity Authority (CEA) of India as given in table below.

Harmonics generated	132kV system
THD for voltage	Not more than 5%
Any individual harmonic	Not more than 3%
THD for current	Not more than 8%

6.7.4 Assuming an Initial demand of 30MVA, the Contractor shall install power factor correction device to improve power factor from 0.85 to 0.95 by installing 50 % static and 50 % variable capacitors or 100% Variable capacitors(without permitting to go in leading power factor) capable of up-gradation when full load of 60/84/100MVA materialises in future.

6.7.5 The design of 12000 HP locomotives is planned to limit the harmonics specified in the table below for stages of operation of 100 % down to 50%, working in a train. However for the existing locomotives on IR, harmonics measurement shall be carried out for the purpose of design.

S. No.	Interference current	Limit
1	Psophometric current	10.0 A
2	DC component	4.7 A
3	Second Harmonic Component (100 Hz) and 83.33 Hz component	8.5 A
4	1400 Hz up to 5000 Hz	400mA

6.7.6 The Contractor shall prepare a detailed document on power quality and obtain prior approval of the same from Engineer.

6.8 SWITCHGEAR AND PANELS

6.8.1 All switchgear and panels shall be vermin proof, constructed from mild steel finished with anti-corrosion paint. The proposed colours shall be submitted for review by Engineer. Anti-condensation heaters shall be supplied where necessary. Ingress Protection Class at a minimum shall be IP 65 for outdoor installations and IP 54 for indoor installations.

6.8.2 The switchgear shall be designed motorised, draw out type such that a failed circuit breaker/ interrupter can be taken out and replaced within MTTR of 4 hour maintenance period.

6.8.3 Switchgear shall have appropriate terminations to suit the locations and electrical clearances. Where the size of available gland/ terminations is small the Contractor shall use cable box terminations to maximize the electrical clearances to the operational railway.

6.9 PROTECTION SCHEME

6.9.1 The Contractor shall define the Monitoring, control & Protection philosophy and furnish a scheme of protection with fast discrimination and reliable operation based on latest state-of-the-art computerised logic protection scheme. All types of faults on overhead equipment covering faults among conductors for 25 kV feeder, OHE, and earth shall be identified, to facilitate isolation and location (within "± 450 m accuracy) and fault locator differential protection for transformer and the distance protection with at least three zones with back up protection shall be provided for feeders. The traction switchgear and cables / feeders on supply side and the catenary on railway side must have sufficient protection. It shall have over current protection for traction transformers with inverse definite time relays set to the rated load, earth fault protection, Buchholz relays, winding and coolant temperature detection under normal and extended feed condition.

6.9.2 The impact of trains with regeneration shall be taken by the Contractor while designing protection scheme. Definite time over-current and back up over current shall be provided. Breaker re-closing facility shall be provided and after first re-closure on the persistence of fault, breaker shall not be closed. Detailed scheme shall be put up for approval of the Engineer at design stage.

6.9.3 The scheme of protection shall be fully coordinated with Indian Railways / PGCIL .

6.9.4 The Contractor shall submit detailed fault calculations, relay settings and fault coordinated curves showing proper protection, discrimination between all upstream and downstream equipment.

6.9.5 All protection functions available in the manufactures specifications shall be available for use of the Employer, without having to purchase any passwords or unlocking codes. Any such passwords or unlock codes shall be available to the Employer free of cost during or post contract.

6.9.6 The Contractor shall design protection system for Power Supply Equipment to ensure:

- (1) Adequate protection and relay coordination with Indian Railways/ PGCIL.
- (2) Adequate discrimination between load and fault conditions under normal and extended feed condition.
- (3) Adequate, required type of monitoring, control & protection system, including the protection relays, Control Relay panel and CTs/PTs etc.

6.9.7 All the relays employed for the protection of the system shall be numerical type conforming to IEC – 60255 or RDSO specifications, wherever applicable

6.9.8 The protection scheme shall meet to the requirements of EN 60076, EN 50119, IE Rules and ACTM and include the following protections as minimum but not limited to:

- (a) 132kV Loop in Loop Out Transmission Line Protection as required:

- Under Voltage
- Over current protection instantaneous and with time delay
- Differential Protection a Special protection for compensation for phase difference between primary & secondary line current
- (b) 132kV Bus protection in TSS
 - Reverse current blocking Scheme only
 - Backup over current protection both instantaneous and time delayed
 - Bus differential Protection
- (c) Main Traction Transformer Protection
 - Over current Instantaneous / IDMT
 - Restricted Earth fault (REF)
 - Differential Protection
 - Internal faults Buchholz,
 - OTI & A (H/L) and Oil Temperature Trip (H)
 - WTI& A(H/L) and Winding temperature Trip(H),
 - Low Oil Level Alarm
 - Transformer Tank Earth Protection
- (d) 54/ 2x25kV LV side Transformer Protection
 - Over current Instantaneous / IDMT
 - Differential Protection
- (e) 54/ 2x25kV Bus Bar protection system
 - Under Voltage Relay
- (f) 54/ 2x25kV Feeding Bay Breakers
 - Over current Instantaneous / IDMT
 - Restricted Earth fault (REF)
 - Distance Protection
 - Under Voltage Relay
- (g) Auto Transformer Protection
 - Over current Instantaneous / IDMT
 - Restricted Earth fault (REF)
 - Differential Protection
 - Internal faults Buchholz,
 - OTI & A (H/L) and Oil Temperature Trip (H)
 - WTI & A(H/L) and Winding temperature Trip(H),
 - Low Oil Level Alarm

- (h) Feeder Protection
 - Special distance protection for regeneration operations
 - Feeder Distance Protection

6.9.9 Disturbance, event recording shall be built in feature and shall be included in the IED (Intelligent Electronic Devices), MFM (multi- function meters) including Data exchange with HMI and PC. The relays, IEDs, MFMs shall be provided with suitable communication interface conforming to IEC 61850 standards.

6.10 GALVANISATION OF ALL OUTDOOR STEEL WORKS

- (1) Steel structures for outdoor TSS, SSP, ATS (if any) and those required for support of overhead equipment, all Small Part Steel works (SPS) shall be hot dip galvanised as per RDSO's specifications No. ETI/OHE/13 (4/84 or latest) i.e. minimum coating of zinc shall be 610 gm/m², except for marine and chemically polluted areas. The Contractor shall carryout the Pollution Mapping of the entire section as per the relevant standards and RDSO guidelines and shall be submitted for approval of The Engineer. The polluted areas as identified as a result of pollution mapping by the contractor and approved by the Engineer shall be provided with the zinc coating of minimum 1000 gm/ m² on Steel structures.
- (2) The galvanisation shall be done only after cutting and drilling work is over. Galvanised bolts, nuts and spring washers shall be used for assembly work.
- (3) Wherever galvanising on ferrous components has been damaged in handling, the same shall be given two coats of zinc chromate primer and two coats of aluminium paints conforming to IS 2339 only after examination and no objection from the Engineer. However, The Engineer shall reserve the right to ask any item hot dip galvanized again if he finds the galvanisation damage extensive.

6.11 MODULAR EQUIPMENT AND COMPONENTS

6.11.1 All components shall be modular, in construction to facilitate easy troubleshooting and replacement of components to minimize down time of the system. Design of components shall be such that it facilitates high level of interchangeability of components i.e. same size of nut bolts, number of fittings of similar type in design, shape & size as much as possible.

6.11.2 Equipment shall be selected from a common palette of materials to ensure that equipment is interchangeable between sites and spares & training requirement on different equipment and systems is kept to a minimum.

6.12 OUTDOOR SWITCHYARD FOR TSS

The layout shall be designed and constructed based on RDSO guideline as applicable and other requirements specified in this PS.

6.13 ELECTROMAGNETIC COMPATIBILITY (EMC) REQUIREMENTS

6.13.1 General

The requirements stated below shall be read in conjunction with the EMC Requirements

in the General Specifications.

- (1) All the Traction system equipment are expected to function satisfactorily in the environment of 132kV, 2x25 kV, 25kV as they may be subjected to and designed to withstand all the High Voltage surges and Power variations. The Contractor shall assess and quantify the impact of EMI and prepare an EMC Management Plan for EMI as may be witnessed in the 2x25kV environment.
- (2) An EMC Management Plan shall be submitted for review by Engineer.
- (3) The EMC Management Plan shall include measures to reduce conducted, induced, and radiated emissions, especially the levels of harmonic, to acceptable values as specified by the relevant international standards.
- (4) The plan shall analyse EMI/EMC impacts of the design of the Traction system on all other train-borne equipment and trackside equipment as well as the general environment. Particular attention shall be paid to additional requirements in grounding, bonding, and shielding, filtering, and cabling arrangements.
- (5) The Contractor is required to conduct type tests as well as full EMC tests. Tests to be conducted shall include but not limited to the following standards:

(a) Overall Compliance:

EN50121-1	Railway Applications Electromagnetic Compatibility – General
EN50121-2	Railway Applications Electromagnetic Compatibility – Emissions of the whole railway system to the outside world
EN50121-5	Railway Applications – Electromagnetic Compatibility - Emissions and immunity of fixed power supply installations and apparatus.
EN50152	Railways Applications – Fixed Installations – Particular requirements for ac switchgear. (All parts)

(b) Specific Standards

(i) Immunity

IEC 61000-4-2	Electrostatic discharge
IEC 61000-4-3	Radio frequency fields
IEC 61000-4-8	Power frequency magnetic field
IEC 61000-4-9	Pulse magnetic field
IEC 61000-4-10	Damped oscillatory magnetic field

(ii) Emission

IEC61000-4-6	Radiated emission
IEC61000-4-16	Conducted emission
IEC61000-2-6	Electromagnetic Compatibility Part 2: Environmental Section 6: Assessment of the emission levels in the power supply of industrial plants as regards low-frequency conducted disturbances.
IEC61000-3-2	Electromagnetic Compatibility Part 3: Limits for harmonic current emissions.
IEC61000-3-3	Electromagnetic Compatibility Part 3: Limits Section 2: Limitation of voltage fluctuations and flicker in low-

	voltage supply for equipment with rated current 16A.
IEC61000-3-5	Electromagnetic Compatibility Part 3: Limits Section 2: Limitation of voltage fluctuations and flicker in low-voltage supply for equipment with rated current greater than 16A.

- (6) The Contractor shall identify all EMC tests to be undertaken in the EMC Management Plan and where appropriate in the integration testing plan to demonstrate the level of EMC achieved. The test plan shall make clear the pass / fail criteria prior to any testing taking place identifying the acceptable limits, conforming standard and achieved results. All tests shall be conducted at severity levels specified by EN50121. The test plans shall be approved by the Engineer prior to any testing being undertaken.

6.13.2 Intra-System EMC

The Contractor shall ensure that all intra-system EMI are taken care of through proper design and other special measures. All major sub-systems shall be tested for emissions and immunities in accordance with the appropriate international standards for equipment operating in railway or similar industrial environment.

- (1) The Contractor shall ensure that all equipment is designed and constructed in accordance with the latest issues or versions of internationally recognized EMC standards, including but not limited to, EN50121 series and IEC61000 series to ensure proper functioning. All applicable standards shall be identified in the EMC Control Plan.
- (2) The Contractor shall also provide computations on the expected conducted and radiated emissions from the power supply system due to electrical fault, load fluctuations, and/or system imbalance. Their effects on the safety-related equipment, especially the probabilities of leading to an unsafe operation shall be determined. An appropriate document for safety audit shall be maintained by the contractor to demonstrate EMC compliance

6.13.3 Non-Safety-Related Systems Interference

- (1) The Contractor shall take appropriate measures to ensure that EMC is achieved between the power supply equipment and all other system equipment. The transformer shall be designed with particular attention to the suppression of harmonic voltages, especially the third and fifth, or any other values as specified in the latest version of the EN 50121 series and other relevant International Standards.
- (2) All radiated emissions, either via the power cables, transformers or any other system components shall be minimised such that they conform to the appropriate international standards. Special reference shall be made to the compliance of EN50121 and IEC61000.
- (3) All power cables shall be properly shielded where applicable. Reference shall be made to IEC61000.
- (4) The Contractor shall ensure that all conducted emissions, including but not limited to harmonics, shall not interfere with telephone, communications, supervisory and control, train protection and control, and other railway equipment via the 25kV AT systems. Reference shall be made to EN50121-5 and IEC61000.
- (5) The Contractor shall also co-ordinate with other contractor/ Agencies whose

equipment are connected to the power supply system and are likely to inject unwanted emissions into the power supply system to reduce such emissions. Reference shall be made to EN 50121 and IEC61000 series.

6.13.4 Environment EMC

The Contractor shall ensure that radiated emissions from the power supply cable are maintained at an internationally acceptable level. The Contractor shall also ensure that the power cables are protected from RF radiations from all telephone network operators and radio networks.

6.13.5 Installation and Mitigation Guidelines

IEC 61000-part 5 -6 series of guidelines on mitigation of external EM influences shall be observed wherever applicable.

6.13.6 Earthing

- (1) The Contractor shall prepare an Earthing & Bonding Management Plan which shall detail the approach for delivering an integrated earthing scheme covering all the systems, service buildings and Indian Railways in proximity. This shall be submitted to the Engineer for approval. This plan shall apply to the Permanent Works by all the Other Contractors/ Agencies on the Project to ensure the structures and equipment are safe from EMI due to 132/2x25 kV traction system effects and for touch voltages and shall form an important interface requirements for the project.
- (2) Earthing system shall be designed to ensure personnel safety and protection of persons and installations against damage. It shall also serve as a common voltage reference and to contribute to the mitigation of disturbances.
- (3) The contractor shall update the Earthing and Bonding Plan to reflect any consequential changes. This plan shall be the basis of design for all earthing and bonding on Traction system, OHE and SCADA infrastructure.

6.13.7 Bonding

- (1) Bonding of all exposed metallic parts of all equipment supplied by the contractor shall be under the scope of work including connecting them to the earthing network.
- (2) Direct bonding shall be used wherever practical. Where indirect bonding via bonding strap is used to connect two isolated items, the bond shall satisfy the following minimum requirements and prevailing international standards, IEC61000 and EN 50122.
 - (a) Low bonding resistance from DC to at least 2 GHz.
 - (b) Low bonding inductance from DC to at least 2 GHz.
 - (c) Proper bonding procedure, including appropriate surface treatment before and after the bonding process, is adopted.
 - (d) Proper use of bond material to minimise electrolytic corrosion.

6.13.8 Cabling

- (1) The cables used shall be adequately protected against external interference. Additional protective measures, including but not limited to the use of metallic conduit, armour, screening conductors, ferrite choke, and EMI filters shall be used

to reduce such external interference wherever required. Covered conduit is preferred.

- (2) A cable routing plan shall be designed to minimise likelihood of coupling between parallel cables. The Contractor shall refer to guidelines recommended by IEC61000.

Table: 6.13.8 Immunity levels at various power ports

Enclosure port	
Test	Severity level
RF field	800-1000 MHz, 20 V/m, 80%AM 1kHz
RF field - pulse modulated	900 MHz, 20 V/m, 50% duty cycle, PRF 200 Hz
Power frequency magnetic field	50 Hz, 100 A/m
Electrostatic discharge	6 kV contact, 8 kV air
RF common mode	0.15-80 MHz, 20 V, 80%AM at 1kHz source impedance 150 ohms
Fast transients	2 kV, 5/50 Tr/Th nanoseconds, PRF 5 kHz
Port for process, measurement & control lines, and long bus & control lines	
Test	Severity level
RF common mode	0.15-80 MHz, 20 V, 80%AM at 1kHz source impedance 150 ohms
Fast transients	4 kV, 5/50 Tr/Th nanoseconds, PRF 5 kHz
Transients common/diff modes	1.2/50 Tr/Th□sec, 2 kV (c), 1 kV (d)
Power frequency	150 Vrms
Power frequency common mode	650 V rms
DC input and DC output power ports	
Test	Severity level
RF common mode	0.15-80 MHz, 20 V, 80% AM at 1KHz source impedance 150 ohms
Fast transients	4kV, 5/50 Tr/Th nanoseconds, PRF 5 kHz
Transients common/diff modes	1.2/50 Tr/Th□sec, 2 kV (c), 1 kV (d)
AC input and AC output ports	
Test	Severity level
RF common mode	0.15-80 MHz, 20 V, 80%AM at 1kHz source impedance 150 ohms
Fast transients	4 kV, 5/50 Tr/Th nanoseconds, PRF 5 kHz
Transients common/diff modes	2/50 Tr/Th□sec, 2 kV (c), 1 kV (d)

Earth port	
Test	Severity level
RF common mode	0.15-80 MHz, 20 V, 80%AM at 1kHzsource impedance 150 ohms

6.13.9 Bonding of Conduits & Cable Armour

Proper bonding & cross bonding of metallic conduits armour & screening conductor shall be made to ensure that the induced voltage in them during fault conditions are within safe limits.

(End of Chapter 6)

CHAPTER 7 - POWER SUPPLY CONTROL POSTS AND DETAILS OF EQUIPMENT

7.1 GENERAL

- 7.1.1 Traction Power Supply System Works include following installations: - One (1) Traction Sub-Station (TSS), Two (2) – Sub-Sectioning & Paralleling Posts (SSPs), Standalone ATS, if any required to be provided. The Contractor shall make his own General Traction Supply Diagram based on the details of locations of TSS and traction supply posts as shown in the relevant reference Drawing (GC/DFCC/PS/GSD/401) in Part-4.
- 7.1.2 The Contractor is advised to note that the neutral section opposite to TSS will have to be located at sites, where single trains of 750m length with one locomotive and also long haul trains 1500 m length with two single hauls with one locomotive on the head and one in the middle will be required to coast through. Accordingly, their locations will have to be judiciously selected to ensure that even on restrictive aspect of signals the engine coast through.
- 7.1.3 Land has been acquired for TSS and SSPs Power Supply Control Posts as shown in the Table 7.1.1 and 7.1.2. The Contractor shall adopt the layout and design of equipment and appropriate Modular technology to reduce the footprint to accommodate TSS/ SSP within allocated land in the ROW maintaining the required Electrical Clearances and without compromising any performance requirement. The status of availability of land for the Supply Control Posts is as follows:
- (1) The location of TSS has been finalized. The Contractor shall locate the Feeding overlap suitably as per the TSS location and the limitations if any due to track geometry or the STOP Signal locations.
 - (2) In regard to SSPs, the required land has been identified, The Insulated overlap locations may also need a review with respect to SSPs locations and the limitations if any due to track geometry or the STOP Signal locations as stated above and accordingly managing the SSPs Equipment as per modular layout in the acquired land running the feeders till overlap/.neutral section.
 - (3) At some locations, the provision of neutral section on the OHE opposite of the TSS may not be practicable in view of these being too close to a stop signal or a restrictive aspect signal for a locomotive to permit coasting through the neutral section without the risk of being stalled. Accordingly, the neutral section will have to be suitably located away to a suitable location with feeders being run within the ROW.
 - (4) Sectioning Switches (Interrupters) shall be provided for mainline appropriately placed, at stations (at both ends) to permit receiving & despatch of the Trains and isolating the fault section ahead and limit the length of fault sections.
- 7.1.4 In regard to SSPs, the General Power Supply diagram provides for appropriate sectioning, so as to permit trains to take alternative paths through stations during traffic and power blocks minimizing traffic delays. Table 7.1.2 indicates the tentative location of the SSPs based on Sectioning Arrangements. The Contractor may review all these locations and prepare his own designs to provide the best sectioning of the overhead equipment for ease in maintenance and operation. Insulated Overlap (IOL) is generally, located in front of SSP. However, the location of Insulated Overlap is also based on location of STOP signals and in consideration of adequate distance, may have to be

located away from SSPs and may therefore call for running feeders for feed to OHE from SSPs.

7.1.5 The proposal for final designs of General Supply Diagram clearly indicating the type of Post being provided at each of the location, may be made to the Engineer for his approval. As per preliminary designs no standalone auto-transformer posts (ATS) have been envisaged. If however, based on the traction simulation studies undertaken by the contractor, need arises for ATS, same shall be proposed and provided by the contractor at his cost. The proposal shall need approval of Engineer. The auto transformer posts, which are stand-alone types, shall be suitably located in the ROW.

Table 7.1.1 List of Proposed Traction Substations (TSSs)

S. No	Installation Name	Approx. IR Chainages / detour (KMs)	Approx. DFCC Chainage (in Km)	Plot Size (sqm)	Spare Transformer(s) requirement	Voltage level at point of Supply/ TSS
1	WAIR TSS	1390.90	1390.90	140x 85	YES	132 kV

Table 7.1.2 List of Proposed Sub Sectioning and paralleling Posts (SSPs)

S. No	Installation Name	Approx. IR Chainages/ detour (KMs)	Approx. DFCC Chainage (in Km)	Available Plot Size
1	SIKANDARPUR SSP	1375.750	1375.750	55mx25m
2	DANKAUR SSP	1400.00	1400.00	55mx25m

- (1) The location of supply control posts shown in the tables above are based on the indicative alignment. The contractor shall prepare his own General Supply diagram based on the final Alignment Plan for the construction Designs and Drawings. The contractor shall accommodate the installations within the available land following : the norms specified in relevant standards.
- (2) The location of Neutral Sections on the OHE opposite TSS may not be most suitable for passage of locomotives. This may call for required lengths of feeder wires to be run between TSS and the corresponding Neutral Sections located suitably.
- (3) There is provision of insulated overlap (IOL) for both the down and up main lines. The IOL's location may also require short lengths of feeder wire to be run between SSP and corresponding IOL.
- (4) Names and chainages are indicative and may change. The Same shall be confirmed while design.
- (5) The Contractor shall design the Equipment as per the feeding zone and actual location of TSS/SSP.

7.2 EXTRA HIGH VOLTAGE POWER SUPPLY TO TSS

7.2.1 The Contractor shall provide all requirements for EHV Line Termination at the TSS to enable the Indian Railways to complete their work and release power supply

7.2.2 The Point of Interface between the Indian Railways owned 132kV, double circuit transmission line and the Contractor will be at the Incomer Gantry of the TSS. The

Gantry will be provided by the Contractor as per the Transmission line termination requirement of IR as well as the TSS. Indian Railways will terminate the transmission line at the gantry. All the Metering bay structures, foundations and equipment after the point of interface towards the TSS, shall be provided by the Contractor.

7.2.3 Check Metering Equipment including all associated metering class CTs and PTs for measuring power consumption shall be installed by the contractor on the incoming supply side of 132 kV.

7.3 TRACTION TRANSFORMER

7.3.1 The indicative typical TSS conceptual Scheme Diagram and layout are attached vide a reference drawing no. DFC/EC/MGS-NBP/TSS/TR-02 (sheet 1 & 2) in Part-4: 'Reference Documents'. The Scott – connected traction transformers shall be manufactured and supplied as per typical specifications furnished in Chapter-19, Annexure-8 of these specifications. In case the contractor proposes any other connection type transformer arrangement meeting performance requirement, the specifications for such proposed arrangement shall be prepared by the Contractor on the lines of specifications of Scott–connected transformers matching /exceeding performance parameter criterion without any limitation during the service life on life cycle cost basis and submitted for the approval of the Engineer ,whose decision shall be final and binding to the Contractor.

7.3.2 Traction Transformer's minimum ratings are as follows. However these are to be confirmed by the system simulation study by the Contractor and subject to the approval of the Engineer:-

Table 7.3.1

Salient Features of Traction Transformers

Sr.	Parameter	Rating
1	Power Rating (MVA)	60 (Minimum) (ONAN) / 84 (ONAF) / 100(OFAF) MVA for SCOTT Connection Type as per General arrangement as referred in Part-4: reference Document or Equivalent capacity for any other Connection type meeting performance requirement as specified here in this specification.
2	Cooling	ONAN / ONAF/ OFAF
3	Connection type*	Scott Connected type/ V- Connected or any other connection type. meeting performance requirement as specified here in this specification
4	Rated secondary voltage	54kV/ 2x27kV
5	Rated Primary voltage Un	132kV,
6	Highest system voltage Um	145kV
7	Non-cumulative overload capacity after the Traction transformer has reached steady temperature on continuous operation at rated power	150% rated load for 15 min 200% rated load for 5 min

NOTE:* The voltage unbalance level shall be within the limit prescribed in Clause 6.7.2 of this specification at Rated Capacity including the overload condition.

- (1) The Traction transformer(s) shall be designed for ONAN/ONAF/OFAF application duty requirement at stringent boundary conditions. The Traction transformer(s) shall be modularly designed so that they can be delivered by rail as well as by road. The Traction transformer shall be designed such that it is within IR SOD and DFCC – SSOD 2013 for Eastern Corridor. Radiators, accessories and conservators shall be removable for transport through road/ train. The Insulation oil may be removed for transport and a nitrogen cushion employed during transportation. Further, the design shall incorporate provision of ONAF/OFAF at a later stage when the load increases upto indicative capacity of 84/ 100 MVA. All the cable works for control and monitoring of the fans and pumps shall be provided by the contractor at the initial stage. The fan motor and pumps shall be operated on single phase AC supply at 230 V. Traction Transformer shall be supplied with ONAN cooling arrangement.
- (2) Fans and cooling pump shall be provided by the Employer in future. However, one traction transformer shall be supplied complete with pumps and fans etc. for carrying out tests for ONAF and OFAF ratings. The Pumps and Fans set may be used at the TSS location as decided by the Engineer including the testing of other Traction transformers. However the Capacity of the traction transformers shall be demonstrated by the Contractor for full load based on the OFAF during FAT/ site simulated conditions as desired by The Engineer.
- (3) The transformer shall be installed on a suitable foundation that can withstand the transformer's static and dynamic load. The foundation shall be able to support the loads during installation and removal.
- (4) The substation transformer bays shall be provided with suitable pulling eyes to allow the transformer to be moved and positioned.
- (5) The transformer(s) shall be located in its own bund (liquid containment). The bund shall contain stone metal soaking pits with voids of capacity adequate to contain at least 110% of total quantity of oil.
- (6) The oil drums shall be stored on their own bund to prevent spillage. The bunds used for oil storage barrels shall be positioned so that they do not get filled with rain water.
- (7) As per safety requirements, the outdoor oil-insulated transformers shall be separated from each other by fire/ Baffle walls for the purpose of limiting the damage and potential spread of fire from a transformer failure. There shall be a Fire/ baffle wall between adjacent transformers and which shall comply with NFPA 221, NFPA 851, IE rules and Indian Standards as per application duty requirement. The wall shall be sufficient to protect adjacent transformer in the event of a catastrophic failure/fire of one of the traction transformers. Fire wall shall be rated for minimum of 4 hour fire rating, the height and length of firewall conforming to IE rules, NFPA 221, 251, 850/851 and designed to withstand the effects of projectiles from exploding transformer bushings or lightning arresters to prevent spread of fire. Firewall to be provided (between transformers) should extend at least 1- ft. (0.3048 m) above the top of the transformer casing and oil conservator tank and at least 2 ft. (0.61 m) beyond the width of the transformer and cooling radiators on either side. The contractor shall calculate the fire load,

effect of wind velocity including the forces due to blast if any and demonstrate the adequacy of Fire wall withstand capacity as supported by a calculation or fire modeling.

- (8) The Traction Transformers shall be provided with Nitrogen Injection Fire Suppression system. Fire load / Nitrogen volume with rate of flow shall be calculated to ascertain adequacy of gas to quench the possible fire.
- (9) The Transformer's noise shall be tested in conformance to IEC60076-10 and shall not exceed 75dB at 1000mm distance from transformer body. In urban areas, the traction transformers shall be enclosed in acoustic barriers where the operational noise contravenes the requirements of the "The Noise Pollution Regulation and Control Rules, 2000 or later".
- (10) The design of the substation layout shall be such that the transformer can be removed by road without disturbing the operation of the DFCC.
- (11) The safety provision shall comply with section - 44 of Central Electricity Regulation – 2010 or as revised (measures relating to safety and electricity supply).
- (12) The full load efficiency of the traction transformer shall be same or better (as 60 MVA ONAN) if a higher rating is offered by the contractor.
- (13) If higher rating transformer is offered then the ONAF and OFAF rating shall be in the same ratio as that of 60/ 84/ 100 MVA transformer.
- (14) The contractor shall comply with the requirements of IEEE Std 519:1992, where such limits are not specified by CEA. As specified in IEEE Std 519:1992, when the harmonic current flowing through the transformer is more than the design level of 5% of the rated current, the heating effect in the transformer should be evaluated. This evaluation will ensure that the transformer insulation is not being stressed beyond design limits.
- (15) Scott Connected type/ V- Connected or any other connection type arrangement to be provided by the Contractor shall have minimum 3 years proven & satisfactory performance on any two Rail systems.

7.4 AUTO TRANSFORMERS

7.4.1 The Contractor shall develop the Technical Specifications for Auto transformers manufactured and supplied generally on the lines of the typical specifications furnished in Chapter 19, Appendix-9 of these specifications in compliance to EN 60076-1 for Capacities (required if any by simulation) higher than the minimum specified if RDSO specification is not available and shall get it approved from the Engineer. The auto Transformers shall not be less than the minimum rating and short circuit capacity of auto transformers as per table below.

Auto transformer	TSS (as required by design)	SSP
Rating	8MVA (Minimum)ONAN	8 MVA (Minimum) ONAN
Short circuit Capacity	35 times	25 times

7.4.2 The safety provision shall comply with section - 44 and other relevant sections of Central Electricity Regulation – 2010 or as revised (on measures relating to safety and electricity supply).

7.4.3 The full load efficiency of the Auto transformer shall exceed than that of 8MVA, if a

higher rating is required as per simulation study and shall be approved by the Engineer.

7.4.4 The Auto transformer capacity as indicated as above is minimum for inter-distance of 13-17 km between TSS and SSP or SSP and the next SP. The Auto transformers shall be designed / sized to meet maximum load requirement of Both Up and Down line to address the contingency of one AT failure at any of the TSS/SSP/ SP (in adjacent section) to cater to the power requirement of other DN/UP line for actual inter-distance, however the capacity of Auto transformer shall be uniform and shall be capable of meeting the requirement of maximum Inter-distance. The capacity shall be assessed as per the stringent scenario of fully loaded train consist as per Train operation plan and provided as confirmed through simulation results and shall be provided higher if simulation results indicate a higher Capacity.

7.4.5 The Auto transformers shall be provided with necessary fire wall between two ATs on the lines of TSS as per applicable standards.

7.5 CIRCUIT BREAKERS FOR 2X25 KV AT SYSTEM

7.5.1 The Traction power supply installations shall be provided with suitably rated Circuit breakers at TSS and SSP. Where gas is used as an Insulation medium, the circuit breaker shall be fitted with a pressure monitoring device that will detect the reduction in pressure and provide a signal via SCADA to the electrical control room.

7.5.2 The command and control signals shall enter the enclosure via pressure tight plug and sockets to provide simple and quick connection and disconnection.

7.5.3 Each circuit breaker shall have a control cabinet with an IP 65 Ingress protection.

7.5.4 The poles shall be able to be operated locally electrically or by a control handle manually from the local control cabinet.

7.5.5 The circuit breaker shall have the minimum of 3 normally open and 3 normally closed auxiliary contacts that are directly driven from the parts of the circuit breaker / interrupter.

7.5.6 25 kV circuit breakers/ Interrupters shall be of vacuum type only.

7.5.7 The control cabinet shall be equipped with the following functions:-

- (1) Local and remote operation switch;
- (2) Open and close buttons;
- (3) Open and close indications;
- (4) Operations counter;
- (5) Control indication monitor;
- (6) Capacitor charge indicator.

7.6 BATTERIES AND CHARGERS

7.6.1 There shall be two Battery Banks and Two battery chargers at each TSS, SSP and ATS (if any) of required capacity and rating. The Contractors shall furnish the Design calculations for Battery set and Battery charger.

7.6.2 Each battery charger shall be capable of supporting the total substation 110V dc operational load.

- 7.6.3 Each Set of Battery bank shall support 110V dc loads for a minimum of 10 hours.
- 7.6.4 The designs of the low maintenance lead acid batteries and battery charger shall be prepared as per IEEE Std. 485 and their capacities and ratings got approved by the Engineer:
- 7.6.5 The 110V battery charger shall be fed from the essential services distribution board that itself will be fed from substation auxiliary transformer.
- 7.6.6 The battery charger shall be located inside the control room. The Batteries shall be located in Battery room or compartment which is vented to outside air.
- 7.6.7 All equipment shall have at least two readily accessible separate earth terminals, which shall be identified by symbol of earth mark adjacent to the terminals.

7.7 CONTROL AND POWER CABLES

- 7.7.1 The cable containment system and run of various cables shall be designed so as to ensure minimum de-rating due to proximity of the other cables adjacent, in tiers and in same duct/ trench. The Cable containment shall conform to IEC 61537 and IS: 1255.
- 7.7.2 Power and Control cables shall be installed preferably in separate cable containments. The Power cables for 25 & 54 kV shall be Copper conductor, XLPE insulated conforming to IS: 7098 part-3, IEC 60502-2 and tested to IEC 60840 including meeting the type tests requirement. Such HV power Cable shall be manufactured with appropriately sized conductor, formation, Non-hygroscopic Semi-conducting tape, Triple extruded XLPE insulation (semiconducting compound, XLPE followed by the semiconducting compound) with water blocking barrier, Metallic shielding/ screen, armour binder tape and ST-2 class PVC over sheath as per application duty requirement of directly buried cables in Ground. The contractor shall furnish the calculations for considering required thickness of insulation/ construction. All the directly buried cables shall have the cable pullpits/ Pull boxes at all turning at regular and at maximum pull length possible and cable trenches used for The Cable laying shall have the Removable Trench covers meeting the requirement of IEC 61537, IEEE525 and IS 1255.
- 7.7.3 All cable shall be suitable for the environmental conditions as per relevant chapter of this specification. Where cables are installed in trenches or ducts the cable shall be designed to function without any deterioration in fully immersed in water or Insulation oil.
- 7.7.4 Cables shall be indelibly marked regularly along their whole length with generally the following information:
- (1) Manufacturer's name;
 - (2) Insulation material;
 - (3) Number of cores;
 - (4) Cable conductor size;
 - (5) Cable nominal voltage;
 - (6) Batch no.
 - (7) Year of manufacture;
 - (8) Country of origin;
 - (9) Conductor length (m).

- 7.7.5 Cable joints shall not be formed in ducts or trenches. Where joints are needed in duct or trenches separate joint bays shall be constructed.
- 7.7.6 All cables and ducts shall have identification plates fitted at the following locations as a minimum: -
- (1) At all terminations,
 - (2) Every 30m along the length,
 - (3) At entries/exits through walls or obstructions,
 - (4) Entry and exits to ducts or trenches,
 - (5) At cable joints.
- 7.7.7 All cable joints shall be allocated cable joint numbers and each joint shall be physically labelled. The location and joint numbers shall be shown on the as built record Drawings.
- 7.7.8 25kV A.C. single core cables shall be armoured. All the cable entry points from yard to TSS / SSP's panel room shall be sealed with EPDM module with fire resistance as per UL 1479 for protection against vermin, rodents and damages.
- 7.7.9 Cable types required on the project have been indicated in table below, however the same shall be verified for the performance required.

S. No.	Voltage		Duty	Core Material	Number of cores	Brief Description	Remarks
	Normal (kV)	Maximum (kV)					
1	25 AC	52.0 AC	Traction power	Copper Conductor.	Single Core	FRLS outer sheath armoured XLPE insulated	Cables laid in parallel as required by system design
2	3.3 AC return current	3.3 AC	Traction power return current	Aluminum Conductor	Single Core	FRLS outer sheath, armoured XLPE insulated	-Do-
3	0.240 AC	1.1 AC	Power Supply to Equipment	Copper Conductor Cable for size up to 16sqmm and <i>Aluminum/copper</i> conductor Cable for size above 16sqmm	2	FRLS outer & inner sheath, Armoured PVC insulated	-Do-
4	0.240 AC and 0.110 DC	1.1 AC	Protection and	Copper conductor multi	As required	FRLS HR PVC rated for 105 ° C	-Do-

S. No.	Voltage		Duty	Core Material	Number of cores	Brief Description	Remarks
	Normal (kV)	Maximum (kV)					
			Control	stranded cable			
5	0.240 AC and 0.110 DC	1.1 AC	Alarm & Emergency Circuits	Copper conductor multi stranded Cable	As required	PVC insulated, Fire resistant , 3 hours rated	-Do-

7.7.10 The cable design and installation shall conform to IEC 60502-1, IEC 60502-2, and IEC 60840 as per appropriate application duty and rated Voltage and IEC 61537, IS: 1255, and Fire Safety Regulations of National Building Code.

7.7.11 Compounds of additives to the cable over sheath shall be anti-termite and resistance and shall comply with internationally acceptable regulations.

7.8 CIVIL WORKS & ILLUMINATION AT TSS, SSP AND ATS (IF ANY)

7.8.1 The Contractor shall perform the Civil and Structural design including all calculations and preparation of Drawings, specifications and other documents but not limited to for the following:

- (1) General arrangement (Layout and elevation),
- (2) Earthwork,
- (3) TSS/SSP control room Building,
- (4) Structures and sub-structures for indoor equipment,
- (5) Foundations for all the equipment including
- (6) Cable trenches with covers,
- (7) Drainage (Covered type),
- (8) Networks (Water Sewage etc.),
- (9) Baffle/ Fire wall between the transformers,
- (10) Transformer/ auto Transformer weight carrying Road in side TSS/SSP,
- (11) Boundary wall / Fencing.

7.8.2 The Contractor shall execute all the civil works and systems works at TSS/SSP etc. as per Vol-5 Particular Specifications – Buildings& Structures including E&M ,as under but not limited to:

- (1) Power supply Control rooms of SSP and Service buildings
- (2) Gravel spreading shall be minimum150mm as per requirements of IEEE-80-2013,
- (3) The Top most level of the trench shall be finished not less than the plinth level and about 100mm above the Gravel level in the switching yards of the TSS, SSP etc. to avoid spill over of the gravels in to open trench if any.

7.8.3 Plinth level of Buildings away from the track alignment

The Contractor shall collect the Highest Flood Level (HFL) from Metrology/ Irrigation/ other statutory Govt. Body for constructing the other Buildings not in proximity of DFCCIL's track. The Plinth level for such Buildings shall be at least 600mm above the Highest Flood Level (HFL) or 900mm above the natural ground whichever is higher.

7.8.4 Earth Work

The Earth work shall be based on final layout plan for the premises giving also the rail level of the final surface as approved by the Engineer.

- (1) Before the earth work is started, the area coming under filling shall be cleared of shrubs, rank vegetation, grass, bush, wood trees and samplings of girth up to adequate depth as required as per site condition and rubbish removed outside the periphery of the area under clearance. The roots of the trees and samplings shall be removed to a depth, as per site conditions. The required holes or hollows filled up with the earth ramped and levelled.
- (2) Earth work in cutting or embankment for the premises of switching station yard and buildings is included in the scope of construction of building. The building will be adequately levelled with earth duly consolidated in the premises or as directed by the Engineer.

7.8.5 Mechanical Compaction

Depending upon the height of the embankment, the type of soil, time available for completing the embankment and other relevant factors, Engineer shall decide the mechanical compaction to be done for embankment. Suitable method for compaction as decided by Engineer shall be adopted by the Contractor.

7.8.6 Excavation

All land cuttings shall be taken down carefully to the precise level as ordered by the Engineer. In case, the bottom of the cutting is taken down deeper than is necessary by oversight or neglect of the contractor, the hollow must be filled up to true depth with selected material and rammed, if approved by Engineer. Cuttings with the formation in rock will be excavated upto 15cm, below the true formation and filled up to true level with cutting soil to ensure that no lumps of solid rock project above formation level.

7.8.7 Cable Trench

Cable RCC Trench with removable trench covers of approved design shall be provided in the yards. The trenches will have a gradient to discharge the water and connected to an interception/ collection sump. Where the trenches have possibility of accumulation of rain and storm water, the water shall be collected in the collection pit and provided with pumping arrangement and pump.

The cable trench covers shall be of RCC type with MS edge protection and noise less flushed with trench walls. The trench walls' top ends will also be with MS angle edge protection. The trenches inside the control room shall be matched with the floor finish.

7.8.8 Drainage

Drainage in the substation and switching posts shall be provided as per the best engineering practices, so as to prevent surface flooding and pooling of water. In addition precaution shall also be taken to prevent transformer insulating oil from being discharged into the environment in the event of a ruptured transformer tank. This shall be ensured by

providing a retention tank with each Transformer of a suitable capacity with a connection to a Collection tank to store 110% of Oil quantity of the highest Capacity Transformer. Minimum of oil spillage and fire risk of one transformer should be considered at a time, however the contractor shall conduct a failure and risk study and assess oil spillage and fire risk and develop the provisions to mitigate all risks. The retention Tank may be constructed below the transformer and shall be covered by a suitable net, to maintain a 5 cm width stone bed on which the drained oil might fall. The retention tank shall be fitted with an extraction pit to be used for oil or rain water pumping. The Slope of drainage pipe from oil collection tank (below transformer) to oil retention pit shall be as per IS 10028/other relevant International/ National Standard.

The Drained volume shall be calculated and submitted to ascertain the adequacy of size to collection pit and elimination of Fire hazard.

7.8.9 Building Walls, Ceiling And Floors

Electrical Control Room Building Wall, ceiling and floors shall be minimum two hours fire rating. The inside surface of the walls shall be as smooth as possible to prevent dust deposits. The ceiling shall be finished in such a way that the equipment is not endangered by fall of plaster. The floor surface must be easy to clean, pressure resistant non slip, wear-resistant. Concrete floor with adequate strength to withstand movement of equipment / panels, wear-resistant, protective coating with ceramic tiles shall be used for the TSS control room. Attention shall be paid to floor loadings when taking the equipment in and out and protected from damages. In front and back of control panels/switchgear panels, insulated mats of adequate designs and latest IS specifications shall be provided. The internal walls and ceiling shall be finished with plastic emulsion paint in control room.

7.8.10 Doors And Windows

- (1) Windows in each room shall be of an area, about 20% of the floor area. Windows must be so arranged that they can be opened and closed without any personnel coming dangerously close to any live parts. All windows shall be fitted with burglar bars firmly fixed to the structure of the building. The windows shall be of aluminum frame of appropriate section and fitted with locks.
- (2) Internal doors shall be fitted with door closure, lever latches and arrangement for locking the same.
- (3) External doors shall have barrel bolts both at top and bottom of one leaf and a Yale type lock on the other leaf, they shall be equipped with an anti-panic system permitting urgent door opening by a means of a bar located at about 0.7 m high from floor level. External doors shall be of solid external quality and secured with heavy duty hinges. Door and Windows shall conform to appropriate fire duty as recommended by the standards.

7.9 CONTROL ROOM & YARD ILLUMINATION

- (1) The TSS, SSP shall be provided with illumination as per the CBIP guidelines.
- (2) General illumination in the control room shall be about 300Lux to provide adequate illumination for readability of meters and Relays.
- (3) The lighting of the TSS and switching posts yards shall be adequate to permit circulation in the external and yard areas. A Uniform lighting level of 50 lux at 1 m from ground level shall be ensured for the entire TSS and SSP switching yards

considering the appropriate height of the Lighting mast as well as number of Luminaries.

- (4) The lighting fixtures shall be installed on the Hexagonal Lighting masts over the conductors Height with adequate clearances. Number masts shall be as per the DSLP and lighting calculations. The clearances of the mast shall not be less than 3.5 m from the conductor. The lighting cum Lightning mast and its foundations shall be structurally designed for highest wind speed & gust factors as per applicable standards.
- (5) All yard lights shall be provided with astro-timers to switch on/ off the lights with sunset /sun rise.
- (6) Complete lighting system as detailed in Vol-5: E&M and associated works.

7.10 NUMBERING OF EQUIPMENT

The number plates of equipment in switching stations shall be non-retro reflective type and meet the guidelines of ACTM Vol.II, 2010. The Equipment Numbering Scheme shall be approved by the Engineer and will be updated to make it compatible with adjacent section.

7.11 132KV, 54KV AND 25KV BAYS, LAYOUTS AND BUS BAR ARRANGEMENT

The 132kV, 54kV and 25kV bays shall be arranged as per the general arrangement layouts of TSS & SSP. The bus bar in 132 kV bays may be flexible type whereas on 54kV and 25kV bays shall be suitably sized rigid aluminum bus bar type for higher short-circuit withstands capacity, reliability and Maintenance friendliness suitably rated for Thermodynamic stress due to short circuit in conformance to relevant IEC/ EN standards.

(End of Chapter 7)

CHAPTER 8 - DESIGN CRITERIA AND PERFORMANCE SPECIFICATIONS FOR FLEXIBLE OVERHEAD CONTACT SYSTEM (OHE)

8.1 GENERAL REQUIREMENTS

8.1.1 General

- (1) This specifications covers complete design, supply, construction, installation, testing and commissioning of Overhead Equipment (OHE) for main lines, yards, and connecting tracks to Indian Railways to provide traction power to trains having trailing loads as per "Train operation plan" in clause 5.2.
- (2) The OHE design shall conform to technical, operational, economical, maintenance and application duty requirements and shall be suitable for local environmental conditions. The OHE system shall be designed as per application duty requirement with sufficient capacity with redundancy to cater to foreseeable load /current demands, without any degradation of any of its components. The OHE design shall be coordinated with the locomotive dynamic performance characteristics to ensure that the current collection quality is maintained within acceptable limits. The overhead contact line shall also be designed, constructed and maintained in such a way that due regard is given to safety of the public, durability, robustness, maintainability and environmental considerations as per EN 50119.
- (3) The principal components of the scope of work shall include but not be limited to the following:
 - (a) Complete 25kV Auto Transformer (AT) fed, Flexible polygonal sagged simple auto-tensioned Overhead Equipment (OHE) including parallel reinforcing conductors along the track, foundations, steel structures, 2x25kV feeders and cross track Cable terminations and associated insulators and hardware, jumpers;
 - (b) +25kV and -25kV cable/Overhead feeders and flexible cable feeder connections from track-side bus to the tracks;
 - (c) Traction Return current Path through rail, negative feeders, AEW and BEC as required.
 - (d) Track Bonding and Earthing;
 - (e) Survey and execution of Safety Earthing of other Service Buildings, adjacent steel structures alongside the track including those of Indian Railways alignment running alongside as required;
 - (f) Provision of Isolators with earthing heel in protected sidings;
 - (g) 25 kV OHE system for yard lines at the stations and for the connecting chords of IR.
 - (h) 25 kV OHE system for New Lines, being constructed by CST contractor CP -302 in the IR yard, as per IR specifications, with the approval of Engineer.
- (4) The OHE shall also accommodate the requirements of systems associated with the locomotives & rail wagons, such as clearance envelopes, other schedule of

dimensions, signaling and telecommunication systems.

- (5) The OHE shall be designed for two pantograph operations at full design speed, with pantographs spaced with two trains consists coupled together with one pantograph in front and another in the middle.
- (6) It would be essential to have computer software-based OHE designs to the extent possible so that repeated detailed calculations are reproducible easily for different locations and loading conditions of overhead equipment for ease of quick & techno-economical designs through computer software in compliance with EN: 50119.
- (7) For ease of construction as well as maintenance and smooth inventory control, designs of different fittings, fixtures, insulators, droppers, clips, clams etc. should be of maximum interchangeable types.

8.2 FACTORS GOVERNING DESIGN OF OHE

8.2.1 Track Structure And Formation

The Contractor shall design the OHE & Traction Return Supply system considering the Track formation Data. Highlights of the track work specifications constructed by the CST package CP- 302 are indicated in General Specifications, Vol 1.

8.2.2 Earth Work

The actual details for earth work including formation width, embankment, curves and other track parameters shall be obtained from CST contractor for OHE system design and continuously coordinated for access with CST contractor. For OHE design, the values of actual cant shall be obtained from the CST contractor. Indicative values are however given in General Specifications, Maximum Moving Dimensions (MMD) and Structure Gauges as per the details given in DFCC – SSOD – 2013 of Eastern DFC.

The OHE shall be designed as per Maximum Moving Dimensions (MMD) ensuring adherence to the Minimum Electrical clearance and additional clearance as required for working as well as considering increased gap to minimise Power interruptions/ CB tripping due to birds/ crow electrocution. The Contractor shall ensure that the proposed size and location of Works including Contractor’s works are outside the Structure Gauge.

8.2.3 Provision in the designs for Low joints in the track:

For low or loosely packed joints a difference of 10 mm in the opposite rail shall be taken as the basis for estimating the displacement of the Pantograph with respect to its normal position.

8.2.4 Displacement of track due to slewing:

The slewing allowance shall be taken as 100 mm.

8.2.5 Motive Power Pantograph Characteristic

The Pantograph details shall be as follows (Bow profile of the Panto-Pan shall be as per RDSO/ELEC/DTE/SKEL. 3871):

a)	Maximum width (Including Horns)	2030mm
b)	Number of collector strips	2
c)	Collector material	Metalized carbon strips

d)	Working width of the head	1040 mm
e)	Static contact force	7 ± 0.4 kg on OHE
f)	Working range (above rail level m)	4.58 to 7.55

8.2.6 Design Speed

The overhead equipment shall be of simple sagged polygonal type design auto-tensioned in conformance to EN50119 and shall be designed for a maximum line speed of 120 km/h, and a normal operating speed of 100 km/h.

8.2.7 OHE Structures On Bridges

- (1) Locations and details of Major bridges/RFOs may be referred to in the alignment drawings and typical arrangement drawings given in Part-4 of these documents. Structures to support traction overhead equipment may be required to be provided on the bridge piers. Exact span of Bridges shall be taken from the CST contractor.
- (2) On long bridges and long viaduct, OHE anchors and supports may also be required on bridge/structures itself. On through girder bridges, the overhead conductors and pantograph swept path shall have to be provided with adequate electrical and mechanical clearances. These may need special designs to meet the additional clearances and support requirement.
- (3) The design and erection of OHE structures on these bridges and earthing & bonding of all structures shall be carried out in close co-ordination with the CST - contractor.
- (4) For OHE masts to be erected on bridges and viaducts, the Civil Contractor (**CST-302**) shall provide holding down bolts for fixing Masts with base plates. The contractor shall interface with Civil Contractor so that masts with base plate are ordered and fabricated at the supplier's works and duly galvanized after welding and drilling holes in the base plate.

8.2.8 Minimum clearances to be adopted

Table 8.2.8 :- Minimum E & M Clearance (mm)

Item	Normal
25kV Live metal to Earth - Static	250
- Dynamic (passing)	200
25 kV Live metal to vehicles - Static	290
- Dynamic	220
Clearances for different phase (50 kV) - Static	540
- Dynamic (passing)	300
Between conductors of different Electrical Sections Gap at Insulated Overlap	500
Gap at Un-insulated Overlap	200

- (1) Mechanical clearance from the pantograph to any fixed structure, excluding the registration assembly, steady arm or registration pipe of the cantilever, shall be not less than 200 mm, except at locations where a locomotive is expected to halt as a

matter of normal operation. Clearance to steady arms and registration assemblies or tubes used for registration purpose shall not be less than 35mm under worst case operating conditions including dynamic displacement of the vehicle, the pantograph as well as track and maintenance tolerances.

- (2) Contact wire gradients and change in the gradient shall be in line with EN 50119.
- (3) Under Indian climatic conditions, particularly during peak summer months, where the temperature goes as high as 50°C, the thermal expansion of aluminum and copper conductors are different. This has been particularly posing problems while passing OHE traction wires & return feeder wires under heavy over line structures and in areas with thick vegetation growths. Therefore Contractor shall conduct a study and provide clearances as needed. The clearances as indicated are minimum and the clearance between live and dead / earthed portion may be increased where ever possible particularly the stranded conductors, to avoid tripping due to birds coming in proximity and bridging the gap and getting electrocuted, and increasing the reliability of the OHE system generally conforming to General arrangement Drawings of RDSO or Other Standards whichever gives more reliability.
- (4) At over-head bridges, clearances from top of rail to the underside of bridges shall be scrutinized to ensure that adequate vertical clearance is provided: that is linked to the height of the vehicle, the electrical (air) clearance, the height of the catenary, catenary tolerance, track tolerance, bridge structure tolerance(for a new overhead bridge). Criteria for determining minimum vertical clearance are given in the ACTM. To achieve sufficient clearance at over-head bridges, grading of the catenary system height down while maintaining a level contact wire, is an option.

8.2.9 **Aerial Earth Wire (AEW)** is generally kept at higher level to serve the purpose of lightning protection; however the AEW height/ level at the lowest point shall not fall below the contact wire level at the maximum temperature. The Contractor shall arrange the OHE arrangement as per drawing annexed in Part 4 Reference Documents.

8.2.10 The following design features of OHE may be adopted, for possible similarity with EDFC (double line section) / IR system:

- (1) Normal Encumbrance: (Axial Distance between Contact wire and the Catenary wire in a vertical plane at the structure): 1.4m.

- (2) Standard spans

IR considers OHE spans in multiples of 4.5 m from a minimum of 27 m to a maximum of 72 m span length, the designer shall consider the effects of the following but not limited to:-

- (a) OCS conductor blow off,
- (b) Contact wire height,
- (c) Contact wire stagger,
- (d) Contact wire mid-span offset,
- (e) Contact wire stagger effect on tangent track,
- (f) Contact wire deviation due to track movement,
- (g) Mast deflection due to imposed loading,
- (h) Vehicle dynamics,

- (i) Width and sway of the pantograph,
 - (j) Track tolerances, and
 - (k) OCS erection tolerances,
- (3) Stagger of Contact Wire:
- (a) On straight : 200 mm
 - (b) On curved track : 300 mm
- (4) The maximum distance between anti-creep to the Anchor structure: 750m as on Indian Railways.
- (5) Overhead Equipment (OHE) Mast /Structures for the mainline tracks shall be mechanically and electrically independent and shall not be normally located between up and down tracks except where specifically approved by the Engineers. Design for steel structures shall comply with IS: 800 which is the Indian Standard Code of Practice for use of Structural Steel. Design method as adopted in Indian Railways design manual for electric traction may be considered for guidance. Concrete structures shall not be used.

8.2.11 OHE arrangement at Stations and Stabling lines:

The OHE at Stations shall be arranged with adequate isolations to receive the Train at the stations or Loop lines in case the former is faulty. Currently the loop length is suitable for accommodating train length of 750m at crossing stations.

- 8.2.12 The OHE System shall be suitably designed to integrate with the OHE of adjoining sections of DFCCIL for smooth sailing of pantograph mechanically and electrically, giving due consideration to the prevailing weather conditions.

8.3 SECTIONING OF OVERHEAD EQUIPMENT

8.3.1 Introduction

The OHE is divided into electrical sections for maintenance and operating purposes to cater to over-head equipment failures, isolation required for emergency work, apart from isolation for routine maintenance. The switching 'ON' & 'OFF' of OHE for main line sections and yards, shall generally be through remote control from the Operation Control Centre, however, it shall also be operable manually for local Power Blocks. On mainline sections, electrical sectioning is normally provided by insulated overlaps. The section is divided into smaller zones by way of switching stations or isolation of different sections, whenever required. A continuity of the electrical sections is maintained as per approved scheme through circuit breakers, interrupters (on load switches) and off load disconnects switches which may be motorized or manually operated. The sectioning shall be minimum, to provide for flexibility of operation. The indicative sectioning layout for Dadri – Khurja section is shown in the reference Drawing GC/DFCC/PS/GSD/401 in Part 4. The Entire section between Dadri to Khurja shall be sectionalized through TSS, SSPs and Sectioning Switches (SSs) at Stations for main line. Mid-section isolations are not planned; however, isolations shall be provided as essentially needed for minimizing the affected sections in case of faults, without impacting receipt and dispatch at the station through healthy lines. The OHE between the Stations may be under Power block in case of Maintenance or failure, the station Loops shall be planned to be isolated through the Motorized Isolators.

8.3.2 The OHE shall be sectionalized through remote controlled switching and auto fault localisation, so as to maximize the availability of operational track in the event of:

- (1) An overhead equipment failure.
- (2) OHE failure due to external cause
- (3) An isolation required for routine maintenance
- (4) Isolation required for emergency work.

8.3.3 **Sub-sectioning and Paralleling Post (SSP)**

- (1) The SSP sectioning shall be arranged such that movement to various lines and yard line is maintained, by isolating the smallest portion of tracks for maintenance or breakdowns. Portions of station yard can be made dead whilst the rest of the mainline and yard is energized and vice versa.
- (2) At Junction stations there shall also be an isolation point at the boundary between the Eastern Dedicated Freight Corridor infrastructure and Indian Railways infrastructure through a neutral section. The neutral section between DFCCIL and Indian railway OHE including the Chord connection to IR shall be provided by the contractor.

8.3.4 **Traction Substation (TSS)**

At the TSS location there shall be sectionalization to allow one sub-sector/section to be isolated from the next section. The section isolation shall be arranged such that safe isolation can be made for maintenance purposes, whilst the adjacent section remains alive. The neutral section of TSS is to be located such that there are no stop signals in the vicinity. Autotransformers are connected on either side of the Neutral section, one per side of each of the up and down lines, serving as the last AT of the respective feed section

8.3.5 **Auto-transformer Stations(ATS)**

Additional ATS (Auto Transformer Stations) (if any) shall be provided based on the traction simulation study to ensure that the accessible voltage does not exceed the limits laid down in International Standards.

8.3.6 **Isolation of Faulty Auto transformers**

To isolate faulty auto-transformers, each auto-transformer will be automatically disconnected through Circuit Breakers across the Transformer as per IE rule and approved protection scheme. All the Circuit breakers provided for Auto Transformers at TSS/SSP shall be with double pole isolators to facilitate its maintenance. It shall be possible to isolate the faulty Auto Transformer as well the section fed remotely through SCADA.

8.3.7 **Position of Sectioning Switches(Interrupters)**

The Sectioning switches/ Interrupters as required for facilitating adequate sectioning shall be considered before and after the stations as appropriately required such as New Boraki Junction. Sectioning Switches shall be suitably configured with Interrupters to facilitate easy isolation from remote. Single Sidings/ loop lines shall be isolated through Motorised Isolators.

8.4 OHE CONDUCTORS

(1) Nominal Sizes of Conductors

The sizes and materials of overhead conductors, viz the catenary (messenger) wire, the contact wire and the 25 KV (Negative) Feeder wire are given in Table No. 8.4.1 below. The contractor shall, however, design and determine the sizes of AEW and the BEC (as required), to cater to Earthing & Bonding and Step & Touch Potential requirements.

Table: No 8.4.1: OHE Conductors

Conductor	Nominal Size (mm ²)	Material	Remarks
Catenary	120	Copper magnesium	Copper magnesium as per EN50119 or as per DIN 48201 (T1, T2) or RDSO specification if any
Contact wire	150	Copper Silver	Silver bearing copper as per RDSO Specifications No. TI/SPC/OHE/CW (Cu-Ag)/0100(08/2012) or as per EN50119.
25 kV Feeder Wire (Negative Feeder)	288	AAAC	As per EN 50119 shall be used.
Aerial Earth Wire /Conductor	-	ACSR	Material having temperature range up to 80 ⁰ C as per EN 50119 shall be used.
Buried Earth Conductor	-	GS	Material having temperature range up to 80 ⁰ C shall be used

(2) Contact Wire

- (a) The contact wire of size 150 mm² shall be manufactured out of continuous cast rods by any process conforming to EN 50149/ or RDSO guidelines or as per EN 50119.
- (b) The contact wire shall be continuous, i.e. splicing or jointing of the conductors is not permitted between terminations or between cut-in insulators. Splices are primarily used during maintenance and shall not be used in the contact wire and / or catenary wire by way of installation or repair unless approved by the Engineer.
- (c) The nominal contact wire height is taken as 5.5 meters. Minimum height of contact wire from rail level to the underside of the wire shall be 5.470 mtrs. Heights of the contact wire at different locations are covered in the ACTM and the SSOD of EDFC. The Contact wire height shall conform to ACTM and SSOD as amended latest or the recent guidelines issued by Indian Railways. The contractor shall workout the tension lengths and orders to their supplier the drum length for full tension lengths.
- (d) The Overall current carrying capacity of Contact wire shall be considered for 30% worn out condition as per EN 50119.

(3) Catenary (Messenger) Wire

The catenary wire shall be of size 120 mm², conforming to DIN 48201 -T1 and T2, EN 50119, DIN 43138 or any other equivalent international standard.

(4) Aerial Earth Wire (AEW)

Aerial Earth wire (AEW) of adequate size and rating shall be provided aurally adjacent parallel to or above the OHE conductors, attached to OHE supports collectively to ground or to the grounded running rails to protect people and installations in case of electrical faults. AEW provides a continuous return path to fault/leakage current through insulator if any or earth fault between live OHE and the earthed masts and connects to BEC as required. AEW shall be located suitably to efficiently protect against the lightning stroke. The design shall determine the required spacing of interconnections to the rails which must be coordinated with requirements of compatibility with the signaling system. AEW shall be of Aluminum Conductor Steel Reinforced (ACSR) material of appropriate size with fixed termination and erected on mast parallel to the OHE system as per the results of simulation study conducted by the contractor.

(5) Buried Earth Conductor

Buried Earth Conductors as required, of appropriate size, as validated through calculations, taking in to account the possible corrosion over 25 years life, shall be laid on both sides of the alignment and connected to AEW and running rails of both the tracks at regular intervals. This shall be confirmed through the traction power load flow simulation results and the touch / step volts analysis to keep the rail Touch and Step potentials within acceptable limits, both for normal and OHE/feeder fault conditions, as per EN 50122-1 generally as per scheme Drg no. GC/DFCC/OHE/Earthing Bonding/ Concept/TYP-602.

(6) 25 kV Feeder Wire (Negative Feeders)

In 2x25 KV traction systems, OHE line will be equipped with negative feeders of AAAC type of size 288 mm², supplying power to auto-transformers. In two track or multi track areas, two negative feeders will be used, one on each side of the tracks. The NF will be strung from the super masts attached as extensions on the OHE masts or Extended OHE mast. The NF shall normally be placed on the track side of the mast. The suspension insulators of NF shall also follow the norms as given for OHE. The clearance between feeders and the catenary system should remain adequate under adverse wind & highest ambient temperature conditions including gap as essential to minimise the electrocution of birds/ crows as per schematic attached in reference document.

(7) The conductor size as above, including jumpers, droppers etc. shall meet the application duty requirement and will also be validated through detailed design calculations. The Contractor may, where practical, optimize on the number of parallel feeders and shall install them where necessary.

(8) Particular attention shall be paid to design and construction of OHE at critical locations of cross - overs and turn- outs so as to minimize/eliminate the possibility of panto-entanglement with the contact wire in conformance to EN:50119.

(9) The tension length of OHE is governed by the limitations imposed by the expansion and contraction due to temperature changes and the system design chosen to accommodate this change while providing suitable tensioning of the

system. While defining the maximum tension length, particular attention must be paid to the along-track movement and stagger change. Tensions to be adopted in different overhead conductors shall be specified by the designer along with the system of anchoring: whether combined or separately for the catenary and contact wires and accordingly the ATD assembly shall be adopted. The tension length and contact wire pre-sag and gradient shall be decided, supported by the requisite calculations, for smooth and spark-free current collection by the loco pantographs.

8.5 SPLICES, CLAMPS AND OTHER TENSION FITTINGS FOR THE CONDUCTORS

- 8.5.1 The performance of fittings designed to terminate or splice stranded or individual wires is critical to the efficient operation and maintenance of the OHE.
- 8.5.2 The OHE fittings shall be tested in tension, in a special Jig to simulate the load characteristics experienced in service. The contractor shall demonstrate its suitability by FEM Analysis.
- 8.5.3 The tensile failing load of the fitting shall exceed the failing load of the wire or stranded wire with which it is to be assembled and used.
- 8.5.4 When the fitting is tested and assembled to the allocated wire or stranded wire the assembly shall achieve 85% or greater than the specified tensile failing load of the wire or stranded wire.
- 8.5.5 Applicable factors of safety for design shall be as per European standards EN 50119.
- 8.5.6 Splices are primarily for use during maintenance and shall not be used in the contact and/or catenary wires by way of installation or repair. If need arises due to any exceptional reason, same shall be done with specific approval of Engineer.
- 8.5.7 Unless otherwise specified in this bid document, all bolts, studs, nuts, washers and pins used for the current carrying conductors shall be of stainless steel or high tensile copper alloy. However, for all other applications, galvanized steel may be used with particular reference to the prevention of corrosion.
- 8.5.8 All fittings, components and materials to be used on the Project shall be subject to prototype tests as per provisions of Employer's Requirements.

8.6 ELECTRICAL CONNECTIONS

- 8.6.1 The connections shall be robust, to withstand both static and dynamic loads, along track movement, wind pressure (Temperature variation in conductors and operational vibrations).
- 8.6.2 Design of fittings and connections shall ensure no localized temperature rise at the connection to prevent any damage or deformation or adversely affect the mechanical capacity of the conductors or their electrical performance.
- 8.6.3 Where dissimilar connecting materials are used appropriate measures shall be employed to mitigate the risk of bimetallic corrosion.
- 8.6.4 Protective bimetallic tapes and shells shall be used at clamps and terminals used with aluminum and copper conductors and cables.
- 8.6.5 Nominal working pressure shall be kept up to compensate the permanent temperature

deformations and generation of local overheats.

8.6.6 The tapes and shells shall envelope 10mm outside of clamps on both sides.

8.7 FLEXIBLE JUMPERS AND FEEDER CONNECTIONS

Flexible Jumper Wire shall be fabricated from soft annealed, high conductivity copper with stranded conductors. The size of the jumpers shall be decided based on simulation study and temperature rise shall be within limits in extended feed conditions. The jumpers shall conform to DIN 43138.

8.8 FLEXIBLE DROPPERS

Flexible droppers shall be minimum of 10sqmm and shall conform to DIN 43138. Each current carrying dropper shall be of bronze strands and two dropper clamps, one of which is connected to the contact wire, and the other to the catenary wire. The maximum resistance at the joint between the bronze dropper wire and the clamp, and at the contact point between the clamp and the catenary and contact wire, shall be less than the resistance of the conductor of the same length. The maximum temperature rise at the joint and at the contact surface shall not be higher than that of the conductor. The tensile breaking load of the complete joint shall not be less than 90% of the failure tension of the dropper wire.

8.9 BURIED EARTH CONDUCTORS (BEC) Connections

8.9.1 The Contractor shall connect AEW, BEC as required and running rails of both the tracks at regular intervals to keep the rail touch and step potentials under acceptable limits both for normal and fault conditions including Auto Transformer Failure Condition. It shall be the responsibility of the Contractor to determine the sizes of the AEW and BEC as required, distances of their connection to rails/earth so as to ensure a safe system both under normal and fault conditions as per EN-50122-1. For the calculation purpose time duration for clearance of fault may be considered as 300ms.

8.9.2 BEC conductor as required shall be connected to Rail, Masts and earthing stations as per the Indicative Schematic by the Contractor.

8.10 CANTILEVER ASSEMBLIES

8.10.1 The cantilever assembly shall conform to EN 50119. The contractor may adopt the cantilever assembly conforming to RDSO / IR specifications/ design, if it meets the functional requirements of the project. In case the contractor offers any new Cantilever Assembly design, the same shall meet the proven design criteria as per clause 4.4.2(6) of this specification. Cantilever made of fibre shall not be used.

8.10.2 The Contractor shall ensure that the range of cantilever frame components is suitable for the loadings and applications shown in the Drawings and these Specifications.

8.10.3 The proposed cantilever frames will sustain the normal and worst case loading conditions with a factor of safety not less than 2.5.

8.10.4 The cantilevers shall be designed such that they can be pre-assembled off site for delivery to site. FEA (Finite Element Analysis) of the Cantilever Assemblies shall be carried out and got approved from the Engineer.

- 8.10.5 The contact wire registration profile shall accommodate the permissible extremes of uplifted and swayed pantograph movement in addition to the effects of track tolerances and include allowance for mechanical and electrical clearances and to be in accordance with the stipulations of DFCC-SSOD-2013 for Eastern corridor.
- 8.10.6 Fittings connected to the in-run contact wire shall utilize the wire groove and shall be shaped to maximize clearances to the pantograph head when uplifted by the extreme operating running conditions and shall take account of pantograph and contact wire wear and to be in accordance with the EN/ IEC standards.
- 8.10.7 Assemblies shall allow for the adjustment of contact wire stagger and the equivalent catenary adjustment by 75mm either side of the designed position without changing components.

8.11 OHE ASSEMBLIES, FITTINGS, HARDWARE

- 8.11.1 The fittings, tubes and hardware shall confirm to RDSO/CORE (Indian Railways) specifications for these items subject to their suitability for the ratings and situation applicable for use on the dedicated freight corridor (Eastern). Where the Contractor offers components of different ratings, design or configuration conforming to other National and International specifications of proven design, details of the specifications and performance elsewhere shall be furnished for approval as per provisions in clause 4.4.2 of chapter 4 of these specifications.
- 8.11.2 All threaded fasteners, washers, headed pins and locking pins etc. shall generally conform to appropriate Indian Standards Specifications. The Contractor shall prepare and submit for the Engineer's approval a list of all applicable specifications for threaded fasteners, washers, headed pins and locking pins etc.

8.12 AUTO TENSIONING DEVICES

The tension in the contact and catenary conductors of the flexible overhead equipment shall be regulated at all temperatures by auto-tensioning devices of proven design at both ends. The Auto Tensioning Device shall conform to EN 50119. The contractor may adopt anchoring of catenary and contact wire on same mast or separate mast through single/ double regulating equipment as per application duty requirement. The breaking strength of the stainless steel wire/rope shall not be less than 2.5 times the maximum computed working load. The use of gas ATD shall be restricted to viaducts and tunnels.

8.13 25 KV CABLES

- 8.13.1 25kV,AC cables shall be XLPE Insulated, armoured, single core copper conductor Cables conforming EN/IEC 60502-2, IS:7098-3 meeting the application duty requirement and tested to EN/IEC 60840 as per the 52kV class Insulation. The insulation thickness shall meet the Testing requirement of EN60840. The outer sheath of the cables shall be protected against ultra violet radiation. The Cables laid in the ground shall be provided with Radial and longitudinal water ingress protection in terms of relevant standards and shall be tested for water penetration test. The Cable shall conform to the laying method requirement and de-rated suitably as per the stringent condition witnessed by the cable. The Conductor shall be provided with semiconducting screen tape and triple extruded layers of semiconducting compound, XLPE and semiconducting compound with Longitudinal water absorption/protection layer /insulation metal shield, Round wire

armoured, Binder tape and Over sheath at least ST-2 class as per application duty requirement.

8.13.2 In order to protect the insulated cables and associated equipment from atmospheric voltage surges, TSS and traction switching station feeder cable connections to the OHE shall be provided with gap less lightning (surge) arrestors with leakage current detector and surge counters.

8.13.3 Cables shall be placed in protective metallic Pipe/ conduit to protect the cable vertically up to a height of 1.8m above the ground to protect against mechanical damages/ vandalism. The Bottom end of metallic conduit shall be embedded in the concrete/ the plinth level of structure and top end shall be sealed to avoid the trapping of the Rain water.

8.13.4 All the Cables shall use the Heat shrinkable Termination kits as per the applicable standards to protect against the ingress of water and terminations.

8.14 STRUCTURE/UPRIGHTS AND THEIR FOUNDATIONS

8.14.1 Overhead equipment structures for the main line tracks shall be mechanically and electrically independent and shall not be located between Up and Down tracks except where specifically approved by the Engineer. In station yards, having more than 3 tracks, generally, portals shall be erected as per yard plan. Portals with larger number of tracks as per yard plan may also be required in station yards. For this purpose, adequate track centers shall be provided by the other (Civil and Track Work Contractor). Design for steel structures shall comply with IS 800- Indian Standard Code of Practice for use of structural steel in General Building Construction. Pre-stressed concrete structures shall not be adopted.

8.14.2 The structures/ uprights shall generally be embedded in PCC/Reinforced concrete. The Concrete for the foundations shall conform to EN50119, BS 8004. In view of the faster installation requirements and 13500 mm wide track formation width, mechanically augured/ excavated, Cast in Situ Cylindrical foundations mechanically augured not less than M-20 grade concrete of suitable size, may be proposed as compared to rectangular foundation design generally used in Indian Railways. For RCC foundations, the reinforcement shall be connected to the Mast for ensuring it as an Earthed structure as per EN 50122-1. Precast prefabricated foundation shall not be used.

8.14.3 The Contractor shall carry out geotechnical survey. This data shall form the basis for design for foundation as per EN50119. The Contractor shall undertake sufficient Geo Technical investigation to demonstrate that the foundation designs are adequate. The consideration shall be given while design of Foundation to all the factors including the electrical resistance of the foundation to earth as per EN50119 and foundation design calculations shall be furnished.

8.14.4 Location and Setting distance of Structures

- (1) Location of structures shall be selected after ensuring that there are no infringements and they do not obstruct roadways, pathways, run of cables, drains, or the sighting of DFC or IR signals etc.
- (2) Setting distance of fixed structures shall not be less than that specified in SSOD for EDFC. This shall be however, subject to review by the Engineer. The location of traction masts shall be such that visibility of signals is not obstructed and shall be as indicated in ACTM. The OHE supporting masts/portals/ drop arms etc. shall

be coordinated with signals locations to ensure clear signal visibility.

(a) Extra clearance on Curves

The minimum setting of structures on curves shall be increased by the figures for curve allowance being taken from Schedule of Dimensions for DFC Eastern Corridor.

(b) Structures with Counter Weights

In case of structures carrying counter-weight assemblies, the term “setting” shall refer to the minimum distance of the mast including the counter-weight from the track center. The minimum and maximum travel of counter weight shall be marked on the mast along with reference temperature.

- (3) To ensure provision of safe & efficient current collection under adverse conditions, the deflection of masts on top of the OHE structure shall not exceed 8 cm and the mast shall be erected such that it becomes vertical on application of permanent loads. The mast shall not further deflect more than 8 cm under the wind load. Torsional deflection under permanent loads shall not exceed 0.1 radian.
- (4) The value of setting distance of masts/structures shall be painted on each mast/structures. The figures shall be 25mm in size in white on a red background. In addition, the track level, contact wire height and stagger shall also be marked on the mast/structure by a horizontal red painted stroke.
- (5) **Numbering of Structures Carrying Overhead Equipment**
Structures shall be numbered, in accordance with the standard numbering given in the finalized overhead equipment layout plans. Number plates at eye level from a locomotive driving cab (approx. 3m above rail level) shall be provided on each mast or structure. Details to be submitted for review by Engineer.
- (6) **Signage for OHE**
Signage shall be provided on steel structures/ standalone boards. All signage shall be retro reflective type in OHE (not PSI). The locations of signs shall be as under but not limited to:
- (a) Number plates on masts/ portals on up and down route
 - (b) Critical locations like before the stop signals and before the permanent speed restrictions.
 - (c) Up and Down Gradients
 - (d) All other warning boards as per ACTM like DJ (Locomotive circuit breaker) open, DJ close, 500 m board, 250 m board, danger board, brake testing board, overhead crossing board etc.
 - (e) Sigma strip shall be provided in fog prone area on two masts prior to all signal locations for easy identification during foggy weather
 - (f) Other unusual locations
 - (g) Guidelines for numbering contained in clause 3.31 of ACTM Vol. II 2010 shall be followed. The proposed location shall be approved by the Engineer.

8.14.5 Construction design shall include the Construction Employment Schedules for structures and the foundations for different situations of loading expected to be encountered on the

route.

- 8.14.6 Field work shall only be commenced when the Contractor has received a letter of no objection to the proposed mast and foundation designs and construction methodology from the Engineer.

8.15 TOLERANCE IN ERECTION:

1.	In Span Lengths shall not vary more than	+/- 200 mm
2.	Cumulative error in all spans in one km shall not exceed	+/- 1000 mm
3.	Height of Contact Wire	+ 20 mm
4.	Dropper Location	+/- 100 mm

8.16 OUTDOOR STEEL PARTS

The zinc coating for steel structures and parts shall be as per RDSO Specification no. ETI/OHE/13 (4/84) i.e. minimum coating of zinc shall be 610 gm / m², except for marine and chemically polluted areas. The polluted areas shall be identified as a result of pollution mapping by the contractor and approved by the Engineer, where the zinc coating shall be 1000 gm/ m². In case of need to use nonstandard SPS at special locations to be fixed to the steel structure, these shall be with clamps to avoid drilling of galvanized mast sections.

8.17 ANTI- CLIMBING GUARDS, SAFETY SCREENS, WARNING /DANGER SIGNS etc.

- 8.17.1 Anti-climbing guards shall be provided for all structures supporting Auxiliary Transformers.
- 8.17.2 Screens and anti-climbing guards shall be provided on OHE supports at locations where any person can either touch or gain access to live overhead conductors, such as the signal posts located near live conductors.
- 8.17.3 Where deemed necessary the equipment and critical points shall be clearly identified with warning and danger signs positioned at appropriate intervals, distance and heights.
- 8.17.4 All safety critical items shall be secured by bolts, clamps, etc., and shall be fitted with vibration and shock proof, self-locking washers or secured with split pins behind the nuts.
- 8.17.5 The device shall be clamped to the structure that it protects, and no drilling of the structure shall be acceptable.
- 8.17.6 The anti-climbing guards shall be positioned to allow unimpeded access to maintenance staff during the normal course of their duties.

8.18 INSULATORS AND SECTION INSULATORS

8.18.1 Insulators

- (1) All insulators shall be suitable for use in tropical environment. At locations subject to pollution longer creep-age path, composite polymer insulators shall be provided.
- (a) For this purpose, the Contractor shall undertake a survey, tests and a

pollution mapping study to categorize levels of pollution level along the route in order to provide insulators suitable for the level of pollution in the zones, structure protection and other protective measures for the OHE. The governing specifications to determine the level of pollution for Insulation and corrosion resistance shall be EN 50119.

- (b) The insulators selected shall be Maintenance free with higher Creepage distance and long life and should not require any cleaning. Insulators shall have codal life more than the life specified by Indian Railways
- (c) All insulators shall be, anti-tracking, solidly bonded with weatherproof seals to appropriate end caps.
- (d) Porcelain insulators as per RDSO Specifications No. TI/SPC/ (OHE)/ INS/0070 shall be provided at all locations except at polluted locations where insulators as per RDSO Specifications No. TI/SPC/ (OHE)/ INCOM/0070(04/07) shall be used. The locations where polluted zone type of insulators is to be installed shall be proposed after survey and shall be installed with the approval of the Engineer.

8.18.2 Section Insulators

- (1) The Section Insulator (SI) is a device installed in the contact – catenary wires system for electrical separation of two elementary electrical fields while allowing for the passage of a vehicle pantograph, such as in a cross over between two adjacent tracks. The SI shall consist of an insulator located in the catenary wire above an insulator located in the contact wire immediately below it. The contact wire insulator is designed to allow passage of the loco-pantograph across it. To ensure continuous current collection during the pantograph passage, the most commonly used SI contains a side runner located on each side of the unit: the side runner overlap.
- (2) Section insulators shall not be installed in main line equipment. These shall operate at the required speeds in either direction.
- (3) The section insulator shall be compatible with the mechanical and electrical characteristics of the contact wire, and the system power and electrical clearance requirements for the overhead contact system.
- (4) Type test validation shall be required for the section insulators proposed for the contract.
- (5) The section insulator offered by the Contractor shall be light weight of a Latest design with proven performance in mechanical, electrical and environmental conditions as specified in these specifications. The section insulators shall be designed to withstand arcing caused by the passing of pantographs with no reduction in mechanical and electrical integrity even if a pantograph runs into an isolated section for a period of three (3) seconds.
- (6) The governing specifications for the electrical and mechanical testing requirements for insulators shall be according to EN50151, IEC 61109 and EN50119.

8.19 DESIGN OF NEUTRAL SECTIONS

- (1) Neutral Sections (NS)/ Phase breaks are insulating units installed in the OHE

System that achieve electrical phase separation while allowing physical continuity of the contact wire for the passage of a pantograph. The Phase Break is used to separate different over-head electrical phase sections.

- (2) NS are located away from passenger stations, signals or any location where a train may stop, as the train must coast through the phase gap at a reasonable speed of optimum operation.
- (3) The neutral sections shall be short PTFE type conforming to RDSO design.
- (4) The section is planned to be provided with Automatic colour light signaling. Also the section may be undulating with 0.5% ruling grade.
- (5) The location of neutral section for the TSS and at location interfaced with IR in Junction Station is to be judiciously selected such that trains are able to coast through the TSS with power off with least risk of stalling.
- (6) Accordingly, their location shall be subject matter for interface coordination with the signaling works and civil works. The track alignment Drawings and station layouts particularly at junction stations may be carefully examined and location of Neutral sections proposed accordingly and coordinated with CST contractor. The neutral sections on connection to IR should be as close to IR as feasible.
- (7) Feeding posts at or near TSS locations are also provided with PTFE neutral sections to facilitate feed separation.

8.20 EARTHING AND BONDING SYSTEMS FOR OHE and STEEL STRUCTURES

- 8.20.1 The contractor shall develop Earthing and Bonding Management Plan with measures to connect all the structures/ buildings in proximity of Track system and provide low potential earthed rail system including the provision of the Earthing stations, Earth mats, AEW, BEC as required. The Contractor shall demonstrate through calculations the rail potential rise within the prescribed limits during stringent fault conditions as specified in EN 50122-1.
- 8.20.2 The Earthing, Bonding and Safety system design shall provide the means to carry electric currents into the earth under normal and fault conditions, without exceeding any operating and equipment limits, without thermal degradation or mechanical breakdown and without adversely affecting continuity of service. Earthing & bonding should create a conductive path that shall achieve potential equalization of the grounded elements of the railway system.
- 8.20.3 Adequate Bonding shall be designed and installed throughout the entire electrified route to provide return circuits for the normal traction power currents as well as fault current as may be witnessed during the broken rail or Rail Maintenance without raising the touch potential and compromise to the safety of General public or Rail personnel in proximity/ touch. The contractor shall demonstrate the potential rise in all possible OHE/Power fault case scenarios remains lower than the permissible limit at any point as per relevant standards including step and touch potential while on going discontinuity in Rails unnoticed like hair cracks etc. and discontinuity of AEW due to failure/theft if any in two independent systems.
- 8.20.4 Work shall be taken up according to the approved Earthing & Bonding Plan prepared by the contractor and shall include as under:

- (1) Survey and tests for soil resistivity as required for earthing requirement,
- (2) Provision of earthing stations and earth mats to limit the step and touch potential,
- (3) Connection with running rails, Masts, AEW and BEC as required,
- (4) Connection to Buried rail at TSS & SSP and other stand alone AT locations if any,
- (5) Separate and Distinct Earth Station for Lightning Arrestor,
- (6) Passing of the return current through mass of earth,
- (7) Provisions of return current cables,
- (8) Grounding interconnection,
- (9) Grounding (Earthing), Bonding and Safety provisions of all items, equipment & sites which include OHE structures, auxiliary transformers, all switchgear, buses, cables, feeders, equipment enclosures, associated buildings and other fully or partially conducting items likely to come in contact with rail systems personnel, rail users and general public.
- (10) The OHE masts/poles shall be grounded through interconnections of the mast to the AEW so that the ground resistance of the interconnected masts is kept low. RCC and anchor bolt foundations, where the concrete is in good contact with the adjacent soil, are recognized as being good earth electrodes. But where the ground resistance of individual masts exceeds 25 ohms, individual ground rods or other grounding solutions shall be applied by the contractor.
- (11) Ground connections to disconnect switches and ground leads from surge arrestors, shall have a maximum ground resistance of 5 ohms. Ground rods or a ground mat may be used to obtain the required ground resistance.
- (12) All metallic equipment & structures shall be connected to the grounding network.
- (13) Survey and implementation of EMC/ EMI mitigation measures including earthing and Bonding limit induced emf within permissible limits on adjoining Electrical, Signal & telecommunication and any other installation.
- (14) All the earthing & Bonding requirement of Indian Railways as stipulated in the interface coordination documents.
- (15) Contractor shall furnish a certificate to the Engineer to this effect to have complied all earthing and bonding requirements prior to commissioning of OHE.

8.20.5 The work includes the earthing and bonding of steelwork.

- (1) Connectors, Clamps and lugs shall be bolted to structures with bolts, washers & lock nuts.
- (2) Earth Electrodes: shall be at least 1.5 m away from any structure so as not to interfere with its foundation.
- (3) Connectors: Exposed and buried earth connections shall be of type and in conformity with IS 3043 - Code of practice for earthing.
- (4) The earthing connections shall be through fasteners for exposed connections or shall use exothermic welding procedure.

8.21 RETURN CURRENT CONNECTIONS FOR AUTO TRANSFORMER (AT)

- 8.21.1 The Traction return Circuit constitute a network of Rail, Negative feeder, AEW, BEC as required and interconnection between rail and them including Buried Rail to AT.
- 8.21.2 Return Current passing through the rails to the AT shall be routed through the buried rail at each location of Auto Transformer.
- 8.21.3 For this purpose, a steel rail (one being used for track) of minimum of 52 kg/m, length of 13 m shall be buried near the track at the above locations at a depth of about 1 m to form a part of the earthing system. The buried rail shall also be connected by means of at least four separate distinct connections made with steel armoured PVC insulated cables of adequate size to the traction rails. In cases where the feeding post is located separately, away from the traction substation, the buried rail shall be provided at the feeding post (where the midpoint of the auto-transformer winding at the substation is grounded).The connections shall be maintenance free, self-gripping type. Wherever, such bonds pass along or across the tracks, it shall be routed along the sleepers using proper fasteners and clamps so as to avoid any damage/disconnection during ballast screening or tie-tamping of the track.

8.22 PROVISION FOR FUTURE ADDITIONS AND ALTERATIONS

The civil engineering station yard plans indicate works of additions and alterations to the yard lines in future such as provision of additional crossovers between main line track and or replacement of crossovers amongst loop lines. Further, some loop lines are proposed to be constructed/ extended in future. The design of overhead equipment, traction installations shall be such that the future additions / alterations are incorporated later on. The present works should be completed in such a way that minimum modifications are required for future additions/alterations as shown in the yard plan.

8.23 INTERFACE COORDINATION BY THE CONTRACTOR

8.23.1 Design Coordination and Interface

The Contractor shall be responsible for design coordination for EMI and safety works related to rendering the whole installation safe from EMI interference and from unsafe touch potential from induction effects of AC traction currents, with all the contractors viz of CPs -302 & 303 - and through the Engineer with adjacent Indian Railway system of both electrified and non-electrified sections, if any.

- (1) The contractor shall be responsible for coordinating the final OHE design and installation at different stages of design and construction, in co-ordination with CST contractors (of CP-302 & also CP-303) and systems contractors (CP-104 & CP-305). As such, the modifications to any structures for provision of OHE shall be subject of interface at the initial stage of design so that the same are incorporated in the permanent works by the CST contractors.
- (2) The contractor shall be responsible for Interfacing with IR/PGCIL for the incoming 132 KV transmission line work.
- (3) The Contractor shall also interface with Indian Railways through the Engineer as follows:-
 - (a) For the design, construction, testing and commissioning of the overhead line

at the Junction Stations.

- (b) To ensure that the design and construction of the OHE does not affect the signal sighting on Indian Railways.
 - (c) To ensure that the construction of the OHE does not interfere with train operation on Indian Railways nor damage any Indian Railway assets.
 - (d) To ensure that the design and construction does not impede the operation and maintenance for Indian Railways in any way.
- (4) The CST contractor shall provide statutory signage and height gauges on the roads and highways crossing of tracks (Level crossings and bridges). The CST contractor shall also provide protective screens for works like extension of ROB/ FOB etc. The Traction System Contractor shall interface and coordinate with the civil (CST) contractor to ensure the provision of these. The contractor shall also coordinate with CST contractor for removal of trees from any work site of TSS/SSPs which shall be removed by the CST contractor.
- (5) The contractor shall also coordinate with CST contractor for Connection with Rail ensuring smooth flow of traction return and fault current back to TSS from the bridges and for ensuring safe touch and step potential under all conditions and shall execute all the necessary works.
- (6) The interface requirements to be met by the contractor have been defined in chapter 18 of these Specifications.

(End of Chapter 8)

CHAPTER 9 - LV SUPPLY AT TRACTION SUPPLY POSTS AND S&T INSTALLATIONS FROM 25KV/240V AUXILIARY TRANSFORMER

9.1 GENERAL

240 V, single phase, LT power supply for Switching posts and Stations and for other S&T installations shall be through Auxiliary Transformers.

9.2 SOURCE OF SUPPLY

240V, single phase, LT supply at TSS, SSP and Auto Transformer Stations (if any) shall be obtained by suitably installing 25kV/240V single phase auxiliary transformer of the following rating:

- (1) TSS – One 100kVA and One 10KVA Auxiliary Transformer connected to 25kV Bus Section.
- (2) SSP and Auto Transformers stations (if any) – One 10kVA Auxiliary Transformer at each switching station connected to 25kV bus bar.
- (3) The connection shall be such that in case of power block or failure of power supply on any one of the lines, the LV power shall automatically switch over to the other line.

9.3 LV SUPPLY AT STATIONS AND S&T INSTALLATIONS

- 9.3.1 The emergency power shall be made available for essential loads by the contractor by installing 25kV/240V, Single Phase, 25kVA(minimum) step down transformers connected to up and down lines. The LT cabling from the auxiliary transformers shall be terminated at the automatic change over switch located in Station as required. The connection for such emergency supply shall be arranged as per the requirement for various station/ Rooms.
- 9.3.2 For S&T installations along the route, supply from 25kV/240 V, Single phase(10 kVA minimum) Auxiliary Transformers, each on UP and DN tracks, shall be the main source of supply and shall be provided by the contractor including laying of LT cables and provision of Automatic Changeover (ACO) switch. The Cable crossing required if any under the track shall be suitably protected through conduits/ pipe as stipulated in ACTM and track crossing regulations. The Contractor shall provide the same in coordination with the CST Contractor.
- 9.3.3 The Cables shall be laid from the output of secondary side to the Automatic change over switch (ACO) installed in the ASM's room or Signalling and Telecom huts in the Dadri - Khurja section.
- 9.3.4 The auxiliary transformer losses shall not exceed as per specified criteria of BEE for 5 – star rating.
- 9.3.5 The Auxiliary Transformers shall conform to specification no. ETI/PSI/15(8/03) and mounting arrangement shall be similar to ETI/PSI/0312 (Mod. B). The efficiency of the auxiliary transformer shall be governed by the total losses at 50% and 100% loading as per the formula given below:

$$Y_0 50\% = \left[\frac{K_{x0} - K_{x1}}{K_{x2} - K_{x1}} \right] x [L_2 - L_1] + M_1 X_1$$

$$Y_0 100\% = \left[\frac{K_{x0} - K_{x1}}{K_{x2} - K_{x1}} \right] x [L_2 - L_1] + M_1 X_1$$

Where:

K = kVA rating of transformer

L = losses

M₁ = Maximum losses for a given star rating

X₀ = kVA rating of Non-Standard Rating Transformer

X₁ = kVA rating of Standard Rating Transformer below X₀

X₂ = kVA rating of Standard Rating Transformer above X₀

L₂ = Maximum losses for a given star rating Standard Rating Transformer
above X₀ @ a particular loading

L₁ = Maximum losses for a given star rating Standard Rating Transformer
below X₀ @ a particular loading

M₁X₁ = Maximum losses of X₁ @ a particular loading for a given star rating

(End of Chapter 9)

CHAPTER 10 - SUPERVISORY CONTROL & DATA ACQUISITION (SCADA) SYSTEM

10.1 GENERAL REQUIREMENTS

- 10.1.1 This Particular Specification defines the objectives, guidelines and requirements for the Contractor's design, supply, installation, testing and commissioning of the Supervisory Control and Data Acquisition (SCADA) system for Dadri – Khurja section. The scope also covers training of Employer's personnel and documentation thereof for Operation and maintenance of SCADA system.
- 10.1.2 The Dadri - Khurja section is in continuation to the preceding Bhaupur – Khurja sections (contract packages CP – 104). The SCADA control and monitoring of the entire section will be from the centralized Operations Control Centre (OCC). The OCC building is being constructed at Allahabad, under the scope of CP 104 contractor.
- 10.1.3 The CP 105 Contractor shall be responsible for design, supply, installation, testing and commissioning of SCADA equipment for control and monitoring of Traction Power Supply installations for Dadri – Khurja section. The CP 105 contractor shall adopt architecture of the SCADA system for Dadri – Khurja section similar to the SCADA system of the adjacent New Bhaupur – Khurja section being implemented under CP- 104 Contract and augment the CP-104 SCADA System, so as to facilitate up gradation and integration of control and monitor of Traction Power Supply installations through the SCADA equipment provided by the CP 104. There is however no bar of adopting a new system which is in compliant with the CP 104 system and integrating it with the CP-104 SCADA system at the centralized OCC with the objective of having the same look and feel for seamless operations at the OCC.
- 10.1.4 The works to be executed under the Contract include the design, supply, installation, testing, including integrated testing and commissioning of traction SCADA system, training of Employer's personnel and documentation thereof for Operation and maintenance of SCADA system as below but not limited to:-
- (1) Remote monitoring and control of Traction Substations (TSS),
 - (2) Remote monitoring and control of Sub Sectioning & Paralleling Posts (SSP),
 - (3) Remote monitoring and control of stand-alone Auto Transformer Stations (ATS) if required as per Traction simulation studies and duly approved by the Engineer,
 - (4) Control and monitoring of all switches including Circuit Breakers, Interrupters, Isolators of TSS, SSP, ATS locations,
 - (5) Monitoring of supply status of Auxiliary Transformers provided en-route the Dadri – Khurja section through Auxiliary Power Supply SCADA system including acquisition of data such as Voltage, Current, kVA, power factor, Maximum demand, Energy etc. with recording facilities and storage of data for a period of 3-Months' time. The similar parameters shall be recorded, monitored & controlled for Traction Power supply system through the Traction SCADA.
 - (6) OHE Catenary Indication with auto fault localization and isolation of faulty section with monitoring fault locations as triggered by Fault Locators acting on the algorithm and logics as approved and reporting to the OCC.
 - (7) Feed Extension to adjoining section(s) of DFCC.

- (8) Return current monitoring shall be done through the traction power SCADA system. In particular the SCADA system shall measure:
- (a) The traction return current returning from the Earth (connection between the bus bar and the Traction Power Feeder grounding system), and
 - (b) The total return current of each main transformer and autotransformers flowing through the cables between the bus bars and the transformers.
- (9) Provision of Complete Power Distribution Cable network and cable containment system at the following locations:
- (a) Provision of All Control and Data Acquisition wiring within TSS, SSP, ATS locations;
 - (b) All SCADA low voltage AC and DC power supply wiring at TSS, SSP, ATS locations;
 - (c) All Traction Power SCADA control and power supply cabling within the OCC;
 - (d) Where cables cross the track or are external to cable trench routes, then these shall be suitably laid through the Pipes as stipulated in IS 1255, ACTM and track crossing regulations. The Contractor shall coordinate with the CST Contractor and provide the same. The Under track crossing conduits shall have a Cable pull pit of size and arrangement as approved by the engineer at both the ends to facilitate cable laying & pulling. The under track cable conduit/ pipe laying shall be through PUSH THROUGH method (without cut and cover) and shall be coordinated with CST contractor.
 - (e) Provision of cable termination/ marshaling boxes at RTU locations and at OCC for OFC cables, where cables enter and leave equipment rooms.
 - (f) Protective provisions relating to electrical safety and earthing of SCADA equipment which include earthing of equipment, cables and non-current carrying metallic components, etc.
 - (g) Work stations (for Dadri – Khurja section)at OCC,
 - (h) In case a new system is installed at the OCC, a Simulator with 2 nos. consoles at OCC for training of SCADA Operators and maintenance staff,
 - (i) Provision / up gradation of data server, application server with 100% redundancy,
 - (j) Provision / up gradation of hot stand-by server with 100% functionality at OCC,
 - (k) Provision of all documentation relevant to the Scheme and Detailed Design, Construction, Testing, Operations and Maintenance in both paper and electronic form including but not limited to:
 - (i) Schemes and architecture of the SCADA system,
 - (ii) Catalogues,
 - (iii) Operation and maintenance manuals,
 - (iv) Data sheets,
 - (v) Release notes,

- (vi) Version control documents,
- (vii) Guarantee and,
- (viii) License certificates.
- (l) Supply, installation, Testing & commissioning of a proven SCADA system with a proven performance with auto fault localization and isolation facilities,
- (m) Monitoring of check metering at TSS provided by the contractor to register all the Power supply & Energy parameters similar to that measured by Power utilities in the similar format and methods to make it comparable,
- (n) Provision / up gradation of protection from viruses and other security protection,
- (o) Integrate Web server with internet connectivity functionality with CP 104,
- (p) Displaying of SCADA information on Video wall supplied for the Dadri – Khurja (CP 105) with the Video Display integrated into the Bhaupur - Khurja (CP 104) Video Wall for seamless monitoring of both the sections CP 104 and CP 105 as well.
- (q) The SCADA system shall interface with Asset Management and Maintenance Planning System at OCC for acquiring real time fault details and equipment operation count.

10.1.5 An indicative conceptual system configuration for the SCADA system Dadri – Khurja section is attached in Drawing no GC/DFCC/TR/SCADA/701 and included in Part 4 of the bid documents.

10.1.6 The Contractor shall undertake the Works & Services described in this document such that CP-105 SCADA works on Dadri – Khurja section do not prejudice or compromise the design, construction, testing & commissioning, operation and maintenance of the Works of other portions of EDFC. The CP 105 contractor shall provide additional hardware and software at OCC and configure and integrate the traction supply control posts of Dadri - Khurja section with the CP 104 so that the operation, indication and protection functions of CP 105 RTUs get seamlessly integrated with that of CP 104 RTUs.

10.1.7 The design and installation of SCADA system shall be based on this particular specification(PS) and based upon best engineering practices and conforming to the following specifications, IEC/EN/ISO/Indian equivalent standards:

[IEC 61508]	Functional safety of electrical/electronic/programmable electronic safety related systems
[EN 50126]	Railway applications – The specification and demonstration of Reliability, Availability Maintainability and Safety (RAMS) [IEC 62278 series]
[IEC 62443-5]	Industrial communications networks – Network and System Security – Security for industrial automation and control systems – Part 5: Technical security requirements for industrial automation and control systems
[IEC 62236]	Railway Applications – Electromagnetic Compatibility
[EN 50121]	Railway applications - Electromagnetic compatibility
[EN 50011]	Limits and methods of measurement of radio disturbance characteristics of industrial, scientific and medical radio frequency

	equipment
IEC 61000-4]	Series of standards - Electromagnetic compatibility – Generic standards – Testing and Measurement Techniques
[IEC 60870-2-1]	Tele-Control equipment and systems- Operating conditions – Power Supply and electromagnetic compatibility
[IEC 60870-2-2]	Tele-Control equipment and systems- Operating conditions – Environmental Condition.
[IEC 60870-5-1 to 5]	Series of Standards - Tele-control equipment and systems- Transmission protocols
[IEC 60870-5-101]	Tele-control equipment and systems- Transmission protocols - Companion standard for basic tele-control tasks
[IEC 60870-5-103]	Tele-control equipment and systems- Transmission protocols - Companion standard for the informative interface of protection equipment
[IEC 60870-5-104]	Tele-control equipment and systems- Transmission protocols - Network access for IEC 60870-5-101 using standard transport profiles
[IEC 61850]	Series of Standards - Communication networks and systems in substations
IEEE 1815-2012	Standard for Electric Power Systems Communications- Distributed Network Protocol (DNP3)
[IEEE 802 series]	Local Area Network
[IEC 61131-3]	Programmable Controllers – Programming Language
[IS:6911-1992]	Specification for Stainless Steel and Strip
[IEC 60297]	Specification for 19-inch rack
[IEC 60529]	Degree of protection provided by enclosures (IP Code)
[IEC 62040]	Specification for UPS
[IEC 60146]	Specification for Semiconductor Converter
[IS 694]	PVC Insulated cables for working voltages up to and including 1100 Volts.
[IS 1554-Part I]	PVC Insulated Cable (Heavy Duty) Electric Cables
[IEC 60255-5]	Insulation coordination for measuring relays and protection equipment – Requirements and tests
[IEC 60255-21]	Vibration, shock, bump and seismic tests on measuring relays and protection equipment
[IEC 60255-22]	Measuring relays and protection equipment - Part 22-5: Electrical disturbance tests
[BS 6651]	Lightning Protection
IEC 61643	Components of low-voltage surge protection devices
IEC 61312	Protection against lightning electromagnetic impulse
IEC 61024	Protection of structure against lightning
[IS 3043-1987]	Code of Practice for Earthing
[EN 50122-1]	Railway applications - Fixed installations - Protective provisions relating to electrical safety and earthing
[BS 7671-2001]	Requirement for wiring Installation, IEE Electrical Wiring Regulations 17 th Edition.

10.2 DESIGN AND PERFORMANCE REQUIREMENTS

10.2.1 Basic Design Requirements

The Contractor shall examine the whole scope of work and scrutinize the specified system, specification for cables and equipment and work out the ratings and capacities based upon his own designs, for approval of the Engineer. The design of the system, including all sub-systems and equipment shall be evolved based on principles as indicated in clause 4.4.3 along with the following additional principles:

- (a) Adequate redundancy in system such that any single point failure shall not degrade the system availability or performance of SCADA system in any way; the second level of failure shall be able to meet with crisscross redundancies.
- (b) Ergonomically designed to ensure no long term fatigue or cumulative injury to the operators;
- (c) Adherence to operational performance requirements;
- (d) Extensive and prominent labeling of parts, cables and wires and use of unique serial numbers for traceability of components
- (e) The SCADA system at OCC shall meet the environmental conditions as below.

Minimum Temperature	- 5°C
Ambient Temperature	- 29°C
Maximum Temperature	- 35°C
Relative Humidity	-Minimum 0%, Nominal 65%, Maximum 95% (Non Condensing)
Electrical Noise	-High Frequency to 1MHz, 1kV damped to 50% after 6 cycles. Radio Frequency field strength 10 V/m, UHF & VHF bands.

Note:

- 1) Air Conditioned Offices, Computer and Equipment Rooms. Air-conditioning failure of less than 2 hours duration at a time is permissible.
 - 2) These conditions do not apply to locations other than OCC. Other locations shall be subjected to general ambient conditions as specified in relevant paras
- (f) SCADA system shall be self-monitoring i.e. failure of any piece of equipment down to the individual RTU Card level (I/O card, Power conditioning, Controller card etc. as applicable) shall cause an alarm locally and at the OCC.
 - (g) SCADA system shall incorporate hardware and software for Multi-tier access control features as per the allowed level of Command that prevents access by unauthorized persons with security features of Password and finger touch/ face recognition; the unsuccessful login shall be alarmed and logged at OCC. Unsuccessful Entry Access to the SCADA rooms at TSS and SSP shall also be logged and alarmed at OCC.
 - (h) Any equipment manufactured shall have its failure rate determined strictly in

accordance with its appropriate operating environment.

- (i) Any degraded mode of operation or re-configuration functions provided by the Delivered System shall not be included in the determination of the Delivered System availability.
- (j) In rare instances failure of a single item of equipment may be tolerated for a short period of time provided that only a small part of the overall system is affected and the occurrence does not take place more than once per year. However, redundancy shall be incorporated where failure cannot be tolerated even for short periods.
- (k) The SCADA system shall therefore be designed around small autonomous items of equipment but shall be commensurate with an economical overall solution.
- (l) Failure of any equipment node on the network shall not affect the local operation nor prevent communication between any other connected equipment nodes.

(m) Noise

All SCADA system equipment shall operate satisfactorily in the very high “electrical noise” environment normally associated with Freight systems due to electrical fields created by traction supplies and strong magnetic fields. Equipment shall be immune to the effects of conducted and radiated electrical interferences.

The SCADA equipment proposed for OCC shall comply following CE norms:

Standard	Norms
EN55022	Electromagnetic Interference
EN55024 (IEC 61000-4-2,3,4,5,6,8,11)	Electromagnetic Immunity
EN 61000-3-2 (IEC 61000-3-2)	Power line harmonics
EN 61000-3-3 (IEC 61000-3-3)	Power line flickers
EN60950 (IEC 60950)	Product Safety

(n) Lightning Strikes / Power Supply Surges and Disturbances

- (i) The design shall ensure that all SCADA system and equipment are fully protected against the effects of power supply surges and direct and indirect lightning strikes and provided with lightning Protection Units.
 - (ii) Lightning protection systems/ units shall be in accordance with BS 6651 – “Lightning Protection” or any equivalent Indian/ International Standard.
 - (iii) All surge suppression equipment shall be self-contained and self-resetting. The suppression equipment shall be so selected that the let-through voltage specification does not exceed the absolute maximum voltage specified for the particular equipment being protected.
 - (iv) Signal lines from external sensors /transducers etc. at risk from the effects of lightning shall have surge suppressers fitted at both ends and shall be installed and connected in accordance with the manufacturer's recommendations.
- (o) The Scope shall include any additional/ necessary equipment and any/ all equipment of higher capacities/ higher ratings for the systems and the sub systems, necessary for the complete, safe, reliable , operable and maintainable

SCADA system.

- (p) The design shall employ the quality procedures and best practices for selecting the equipment. It shall be possible to replace the faulty unit instead of whole equipment

10.3 DOCUMENTATION

Documents to be delivered by the contractor shall include but not limited to the following:

(1) Design Phase/stage

The Contractor shall design the SCADA System as per the design requirements. The contractor shall develop and submit a detailed concept Scheme design and architecture plan of the system and submit the same along with the detailed explanatory notes on functionality for approval of the Engineer. The designs shall be submitted in accordance with chapter 6 of Vol-1: General Specifications. These shall include but not limited to:

- (a) Preparation of SRS on the SCADA ,
- (b) SCADA architecture, SCADA system Hardware Details, RTU Drawings and HMI Design Documents,
- (c) Proven-ness certificates / evidences of Proven & Satisfactory Performance
- (d) The list of Deliverables,
- (e) I/O list,
- (f) Control and Logics of each operation,
- (g) Restrictions, if any for RTU failure conditions,
- (h) Proposal on Determination of SCADA equipment ratings and makes of the equipment in the required format as prescribed by The Engineer;
- (i) Determination of Conductor sizes and core numbers for all control cables for SCADA,
- (j) Identification of the bandwidth required,
- (k) Earthing requirements for the SCADA equipment and calculations of safe touch and step potentials for the entire SCADA System,
- (l) Design requirements taking in account Human Factors and Work Load Assessments at OCC,
- (m) RAMS requirement with MTBF and MTTR and the V&V matrix for each module,
- (n) Type test reports for equipment or components selected for SCADA,
- (o) EMC Control Plan for SCADA,
- (p) Earthing and Bonding Plan for SCADA,
- (q) Logics and methodology on automatic switch over of Servers,
- (r) The detailed procedure for manual switching from the Main server to the other server at the OCC based on design of the SCADA system along with periodicity,

- (s) Hardware and Software Obsolescence management plan,
- (t) Simulator system document along with proposed training plan,
- (u) Interface management plan, includes interfaces with other sub-system/contractors/other sections of EDFC,
- (v) Factory Test, Site test, Integrated test plan, Identification of System critical parameter,
- (w) Control and Logics of the fault localization in different failure scenarios or faults at different points in OHE system and shall submit as a separate diagnostic module,
- (x) Fault diagnostic module for hardware faults,
- (y) Fault diagnostic module for software faults / bugs,
- (z) Modules on various utility Program which may be required by the Operator/management to Capture Historical Data, Trend, Demand control and Alarm Management including power Block management.

(2) Construction/ Installation Phase/stage

- (a) Construction and Installation Plan;
- (b) Type test and Factory Acceptance Test Plan and Report for equipment;
- (c) Quality Plans and RAMS Plans;
- (d) Installation, operation and maintenance instruction of all equipment;
- (e) Records and Drawings of equipment installed;
- (f) Inter-connection Drawings.
- (g) All other records of construction, including hidden parts;
- (h) Site test report of equipment;
- (i) As built Drawings including interface Drawings;
- (j) Earthing and Bonding plans;
- (k) Updated EMC Control Plan and certificates;
- (l) Site access control system; Operation & Maintenance Manual with Fault diagnostic;
- (m) List of installed Spares, spare space in the cubicles, Mandatory spares as delivered and recommended spares.

10.4 TRACTION POWER SUPPLY FACILITIES TO BE CONTROLLED AND MONITORED

10.4.1 The SCADA system shall have adequate number of workstations. This shall be proposed through the Contractor's work load assessment report and shall be subject to approval by the Engineer.

10.4.2 The SCADA system shall monitor & control the equipment at following as a minimum:-

- (1) Tractions Substation;
- (2) Sub-Sectioning & Paralleling Posts;

- (3) Standalone Auto Transformer Stations if needed as per traction simulation study;
- (4) Protection system;
- (5) Measurements at required points;
- (6) Fault locators,
- (7) Power Quality equipment(s) etc.;
- (8) Motorized Isolators and Interrupters in stations/ yards;
- (9) Monitoring of Auxiliary transformer(s) Power supply at TSS and SSPs including those provided for stations.

(According to indicative designs, the location of the principal sites to be controlled and Monitored is shown in drawing no. GC/DFCC/TR/SCADA/701 included in part-4 of the bid document).

10.4.3 The Contractor shall confirm the exact number and configuration of each type of switching station (TSS/SSP) as part of the works described in this Particular Specifications. The SCADA system architecture should essentially include licensing in favor of DFCC for SCADA software, etc.

10.4.4 The SCADA system installed at the TSS shall be uniform with highest I/O points as required for TSS with the required installed Transformer(s)/ Equipment. In addition, the SCADA architecture shall permit up-gradation of SCADA system upto 10% to include more controlled switching stations/ additional equipment.

10.5 INDICATIVE LIST OF EQUIPMENT TO BE MONITORED AND CONTROLLED AT REMOTE LOCATIONS

10.5.1 Table 10.5.1 provides an indicative overview of the typical items of equipment that will be required to be monitored and controlled in each Installation on Dadri – Khurja section of the Eastern Dedicated Freight Corridor. The list is not exhaustive and may not cover all the equipment and functionalities. The Contractor may be required to provide functionalities, Monitoring & Control of more Analog & Digital I/O points as required by the Engineer.

Table 10.5.1

INDICATIVE LIST OF EQUIPMENT TO BE MONITORED AND CONTROLLED AT REMOTE LOCATIONS

Equipment	TSS	SSP	ATS (Auto Transformer Station/Post) (If any)	Stations
Traction Transformers	√	0	0	0
Auto Transformers	√	√	√	0
DP Circuit Breakers for 2x25kv AT System	√	√	0	0
DP Interrupters for 2x25 KVAT system	√	√	0	√
Motorized Isolators for 2x25 KV AT system	√	√	√	√

LA on secondary end of transformer	√	√	√	0
132KV Circuit Breakers	√	0	0	0
132KV Isolators	√	0	0	0
LA on Primary Side of Transformer	√	√	0	0
Power Quality Improvement Equipment	√	0	0	0
Battery Chargers	√	√	√	√
Auxiliary Transformers	√	√	√	√
Low Voltage Distribution Boards	√	√	√	0
Current and Potential Transformers	√	√	0	0
Doors and gate contacts	√	√	√	0
Intruder alarms	√	√	√	0
Access control system	√	√	√	0
Fire alarm system	√	√	√	0
Automatic fault Locator	√	√	√	0
CCTV	√	0	0	0
UPS	√	√	√	0

10.5.2 Above table includes Intruder Alarms and Access Control system status and alarms. The specifications for these items are covered in the volume-5: E&M and associated work. The status of supply for Auxiliary Transformers provided at Power supply installations of TSS and SSP shall also be included in the Traction SCADA.

10.5.3 The contractor shall assess, the requirement of Monitoring, Controls, Measurements as required and prepare an exhaustive list of I/O points, Tele-commands, Tele-signals and Measurements needed during full lifecycle with additional 10% requirement for future extensions and shall seek the approval of the Engineer during Initial stage of Design finalization. The decision of the Engineer on the level of monitoring, Controls and Measurements of Various parameters shall be final.

10.5.4 The SCADA system shall be integrated with the smart card based Access Control and maintenance locking off system provided in Traction Power Supply Installation premises.

10.5.5 The SCADA system shall be integrated with fire control system to notify SCADA Operator for any untoward fire situation at traction power supplies installation.

10.5.6 The video Surveillance system shall be provided for effective real-time video surveillance of the Traction Substation from OCC. The contractor shall provide the video Surveillance for the following:

- a. Main Entrance gate,
- b. Incoming Bay area,
- c. outgoing bay area,
- d. Transformer area and,
- e. Power Supply Control room Building Area

10.5.7 Traction Power Controller (TPC at OCC control room) shall be provided with one additional Client PC workstation with 21 Inch full HD LED backlit colour monitor for viewing, monitoring and management of Video Surveillance Data.

10.6 SCADA SYSTEM PERFORMANCE REQUIREMENTS

10.6.1 The SCADA system fully equipped with all cards and command levels for the TSS whether provided with one or two Traction Transformer(s) and associated bay equipment.

10.6.2 The SCADA systems shall continue to be able to function should there be a mass trip of all equipment at the TSS, SSP and ATS. The OCC shall continue to function normally in such an event. The Server, Work Station and RTU processor and memory usage should not exceed 60% during Mass trip.

10.6.3 Complete SCADA system with servers, workstations, and full communication with all RTU's shall be ready within 15 minutes of a cold restart of complete system. All software shall automatically start up on system restart and system shall be ready for the operator after entering the password/ other security Check like Finger touches/ face recognition.

10.6.4 The SCADA system shall be able to initiate a change of state at the output of an RTU within <1 second of initiation by the control room operator. If this change has not occurred in the field for any reason, the operator shall be notified that the command was unsuccessful. The Contractor shall demonstrate the past performance of similar system provided elsewhere by them with client's Certificate while proposing for implementation on DFCC as per the Scope of work.

10.6.5 The SCADA system shall indicate the change of state or change in alarm status within <1 second of receiving the signal at the input to an RTU.

10.6.6 The Total time of any commanded operation including all propagation delays shall not be >1 second i.e. from Initiation to receipt of Confirmation at work station.

10.6.7 On failure of Main Server the SCADA system should automatically change to standby system without deterioration of performance,

10.6.8 Sequence of Event shall be logged and displayed in event list strictly in chronological order

10.6.9 The SCADA system shall be capable of time stamping with a resolution in conformance to IEC 60870-5-104/OPC UA and IEC 61850 as required.

10.6.10 The SCADA system at OCC shall support data acquisition from RTU or other IED over Ethernet based IEC 60870-5-104/OPC UA.

- (a) Open protocol, with Ethernet can support time stamped Data streaming, clock sync;
- (b) Shall support Ethernet IEE802.3, X.21, Ethernet and RS232;
- (c) Shall Support Data Link Layer- IP (RFC 1661), RFC 894), Ethernet II, IEEE802.3;
- (d) Shall Support Network Layer- IP (RFC 791),;
- (e) Shall Support Transport Layer- TCP (RFC 793)/ UDP;
- (f) Shall Support Application Layer – IEC 60870-5-104 and OPC UA;
- (g) Shall Support -Point to Point, Multipoint, Star, Ring Topology.

10.7 RAMS REQUIREMENTS

The RAMS shall conform to EN 50126 / IEC 62278 -.The contractor shall design the SCADA system to meet the RAMS targets specified for the system.

10.7.1 Reliability Requirements

- (a) The SCADA system shall be of the highest reliability. The OCC equipment shall have 100% redundancy as a minimum.
- (b) In event that the SCADA system fails then the traction power and its protection system shall continue to operate autonomously, until either the SCADA system comes on line or until the switching station is placed into local control.
- (c) All OCC equipment shall be supplied power from two independent sources of supply.
- (d) The design shall consider Multi-tier, Multiuser Security at server level, Operator Work station and backup storage of data in SCADA.
- (e) Single point failure should not impact the SCADA performance.

10.7.2 Availability Requirement

The SCADA system shall be designed to achieve at least the following levels of system availability:

- (a) The complete SCADA system shall be designed to meet 99.99% hardware availability.
- (b) The availability figures for Traction Power functionality and the Traction power decision support system shall be 99.97%.
- (c) The availability figures for other SCADA subsystems viz. Software Development and Training Simulator shall be 99.9%. It shall include required redundancies to render the targeted availability.
- (d) In determining the availability of the Delivered System, Reliability Block Diagrams using expected failure rates for off the shelf equipment shall be produced.
- (e) The System shall be designed to ensure that failure of any major equipment, caused by external accident or negligence of the internal staff or malicious damage by external influences or fire will not lead to unavailability of the whole system, other than a temporary outage of the failed equipment. For this purpose the SCADA system shall provide through pre-determined algorithm the steps to be adopted by the Controller to retain the system in healthy condition to the extent feasible.
- (f) In event of communication failure at any control Post, the particular post shall record changes within the switching station until communications are restored and RTU shall update current status and change history shall be transferred to the master station for recording in the logs of Events.
- (g) The Contractor shall prepare a detailed maintenance strategy for the SCADA system, detailing how system availability will be maintained.

10.7.3 Maintainability Requirement

The SCADA shall employ a unit spare replaceable based maintenance methodology. The Fault diagnostic software shall be able to diagnose and report the SCADA module

(I/O Card, Controller card, Communication Port, Power Supply Unit card) failure. The SCADA system shall have an MTTR of 30minutes excluding the communication failure. This time shall not include the time taken for a maintenance staff to arrive at the initial reported failure site.

- (a) The Contractor shall demonstrate that system maintains and fault diagnostics ability is sufficient to support the claimed system reliability and availability performance. The Contractor shall demonstrate that maintenance errors have been considered and risk of maintenance-induced faults has been mitigated in design.
- (b) The equipment to be supplied by the Contractor shall be designed for minimum maintenance. Maintenance activity required shall be capable of being performed without affecting the train service.
- (c) Maintenance activities shall be classified into two areas, routine preventive and corrective, both of which affect service availability.
- (d) The SCADA equipment shall be selected from a common palette of materials to ensure that equipment/ cards are interchangeable between sites, spares and training on multiple systems is kept to a minimum.
- (e) To optimize speedy corrective attention or maintenance, techniques employing automatic diagnostics test points, and rapid repair facilities for the SCADA and traction system as a whole shall be provided. To this end, expert system algorithm to identify location of OHE faults based on auto – transformer neutral Current & voltage shall be provided to the controller.

10.7.4 Safety Requirements

- (a) The contractor shall demonstrate that no safety loop is infringed due to SCADA failure. The installation design shall incorporate measures to avoid presenting safety hazards to people.
- (b) The Systems design shall incorporate measures to provide for its safe management and operation. The system shall ensure that there is no inadvertent operation of any SCADA controlled equipment.
- (c) The Systems shall not give rise, or be subjected to dangerous interactions within the railway or with other systems through fail safe interlocks.
- (d) The design of the earthing system shall conform to EN 50122-1. The system shall have fail-safe features. The Contractor shall incorporate the SCADA earthing design requirements in the earthing and bonding management plan and design as described in this Particular Specification.

10.7.5 Safety Targets

- (a) The Contractor shall demonstrate that the systems have been designed to minimize the risk due to operator and maintainer error, considering both the ergonomic aspects of the System design to reduce the likelihood of error, and protective measures adopted to mitigate the consequence of such error.
- (b) The Contractor shall show that the systems can be operated and maintained safely. The Contractor shall prepare a quantified risk assessment (QRA) to model the risk to (a) public (b) maintenance and operations staff (c) public and staff on the adjacent Indian Railways line. The QRA may be based on a comparison of System features and operating practices with other high current main line railways

and heavy haul railway systems for which risk levels are known. Accidental charging of dead section due to problem with SCADA or wrong indication causing issue of permit to work on charged section posing safety hazard shall also be prevented.

- (c) Following types of interlocks shall be possible:
 - (i) Interlock between any numbers of items of equipment through OCC such as N-1 interlock.
 - (ii) Interlock locally within equipment reporting to single RTU. This shall be possible without intervention of OCC server.
 - (iii) Interlock between equipment reporting to different RTU's on same LAN/TCP/IP connectivity. This shall be possible without intervention of OCC server.

10.7.6 Specific Safety Requirements

- (a) In addition to the safety rules which shall apply for the entire system, the operation and maintenance of equipment inside the TSS, SSP & ATS shall satisfy the safety rules and system operation requirements of state power companies.
- (b) The system shall comply with all the relevant safety documentation, including, but not limited to 'Project Safety Manual' and any update thereof.
- (c) The system design shall incorporate measures to provide for its safe management and operation. The Contractor shall ensure that there is no possibility of accidental operation of any SCADA equipment.
- (d) The system shall not give rise or be subject to dangerous interactions within the railway or with other systems,
- (e) The design of the earthing system shall conform to IS 3043 : 1987 and EN 50122-1.

10.8 FUNCTIONAL REQUIREMENTS

10.8.1 General

- (1) The Contractor shall design, manufacture, install and commission the SCADA System to provide a safe, efficient and effective means of monitoring and /or controlling the connected equipment as required for the operations of the project.
- (2) The SCADA system shall comprise of three basic elements:
 - (a) Interface with SCADA workstations and SCADA maintenance terminals for displaying the status of connected equipment to operators and providing control facilities for operators for connected equipment;
 - (b) Data communication links with the connected equipment to be controlled and / or monitored within the Project including use of the Data Transmission System provided by S&T contractor.
 - (c) Processing information that allows:
 - (i) The information received from the connected equipment to be displayed in a consistent format.
 - (ii) The controls entered by operators to be converted into a form that

shall be understood and correctly acted upon by the connected equipment.

- (iii) The storage of all controls, events, alarms and measurands of current & voltage readings including transients to facilitate analysis of data and system behavior, including trend.
- (3) The SCADA system shall have levels of redundancy in its equipment and configuration as necessary to meet the System Performance requirements.
- (4) As a minimum, the central servers shall have dual redundancy with one set of servers located at the OCC equipment room interconnected with multiple redundant and spatially diverse data communication links.
- (5) Multiple, redundant configurations shall be used where necessary to ensure adequate operational safety and availability for all the SCADA equipment, SCADA System interconnections and SCADA interfaces to equipment to be controlled and /or monitored.
- (6) Redundancy shall be achieved either with hot standby equipment where only one unit is in use at a location or by utilizing several functionally identical units with an overall capacity such that one of the units may be taken out of use without loss of any functionality.
- (7) The SCADA System shall have a distributed architecture with the majority of I/O being transmitted via high speed data communication links.
- (8) The SCADA system architecture shall be arranged to minimize the requirement for marshaling large quantities and long lengths of metallic control cable to data collection points.
- (9) Primary control and monitoring of connected systems shall be from the SCADA workstations in the central control room combined with playback functionality.
- (10) Additionally, the SCADA system shall include a data link to a maintenance management system (MMS being developed by DFCCIL). This link shall enable the SCADA System to forward fault information to the MMS from all connected equipment to identify the location and nature of faults.
- (11) The mechanism of control and monitoring shall ensure that the connected equipment shall continue to function correctly and in a safe manner in the event of malfunction of parts or all of the SCADA System.
- (12) Control capacity, status and alarm messages displayed at each SCADA Workstation shall be limited / filtered according to the login privileges of the user.
- (13) The SCADA System shall be configured to permit phased commissioning of the project.
- (14) SCADA Software shall be able to carry out concurrent Maximum Demand (MD) calculation and initiate alarm based on the trend of MD before completion of Integration period at OCC as per preset values, which can be altered/set by Administrator as per the requirement. The User friendly provision shall be made in the software for the same.

10.9 DESIGN CRITERIA AND PERFORMANCE SPECIFICATION

10.9.1 General

- (1) The SCADA system shall be designed such that no single point failure of SCADA component results in failure of OCC functionalities or of the SCADA System.
- (2) The SCADA system shall, through 100% redundant Controller, display information on the video wall in the OCC.
- (3) The Contractor shall design and submit all SCADA screens to the Engineer for review.
- (4) The Contractor shall examine the whole scope of work and scrutinize the specified system, specification for cables and equipment and work out the ratings and capacities based upon his own designs, for approval of the Engineer.
- (5) The list of "I-O" requirements giving details of event type, alarm class and event text for TSS, SSP and AT stations shall be submitted and approval obtained from the Engineer. Notwithstanding the Approval of the Engineer, the Contractors shall ensure the complete functionality and minimum of 10% spare Installed I/O Cards of each type. Each installed card shall have minimum of 10 % spare I/O points. In addition the Contractor shall handover the spares as specified in relevant chapter.
- (6) The SCADA system Hardware & software design shall permit making suitable changes/ modifications for / in features or adding new I/O requirements like , alarms in case of maximum demand is exceeded, generating exception reports etc.

10.9.2 Modular Equipment and Components

- (1) To the extent possible all components shall be modular in construction to facilitate easy troubleshooting and replacement of components to minimize down time of the system. Where equipment is of the same type, rating, equipment shall be interchangeable.
- (2) Open systems shall be employed such that if items from one supply becomes economically unviable or non-available, products from other suppliers will be available and compatible. The contractor shall furnish the list of Equivalent cards of all types of cards installed.

10.9.3 Supervision Architecture

- (1) The SCADA system comprises of RTU's at TSS, Switching Posts (SSPs) and Energy Meters at Aux. Transformer Locations for necessary field data collection and data transfer to Control Center.
- (2) Optic Fiber Cable Ring shall serve as the back bone of whole data transmission network and the Servers at OCC will acquire all the information's pertaining to the RTU's over IEC 60870-5-104/OPC UA protocol.
- (3) TSS shall include Protection, Control, Monitoring and transmission to the Local Interface Unit (LIU) and Control Center. LIU can control the TSS after OCC permission.
- (4) The RTUs at TSS, SSPs and Auto Transformer Station (ATS) shall collect data from fault locators and transmit to Control center.

(5) **Control Center**

(a) **Operation Control Center**

The OCC SCADA equipment for Dadri – Khurja section, shall be organized in OCC Theatre and various rooms designated for SCADA purpose. The existing UPS power supply shall be extended to various rooms for SCADA equipment power as required. Also the corresponding communication network shall be established in OCC.

(b) **Local Interface Unit (LIU) in TSS**

The Traction Sub-Station (TSS) shall be provided with RTU capable of communicating with Bay Controller Units (BCU) or Intelligent Electronic Device (IED) over IEC 61850 protocols and shall be further integrated with SCADA system in OCC over IEC 60870-5-104/OPC UA protocol via redundant Gateway. The gateway shall have redundant communication ports for simultaneously reporting to two masters.

The workstation in TSS shall serve as Local User Interface (LUI) for use of local operator.

- (6) Conceptual SCADA system configuration for Dadri – Khurja section is as follows attached in Drawing no GC/DFCC/TR/SCADA/701 and included in Part 4 of the bid documents.

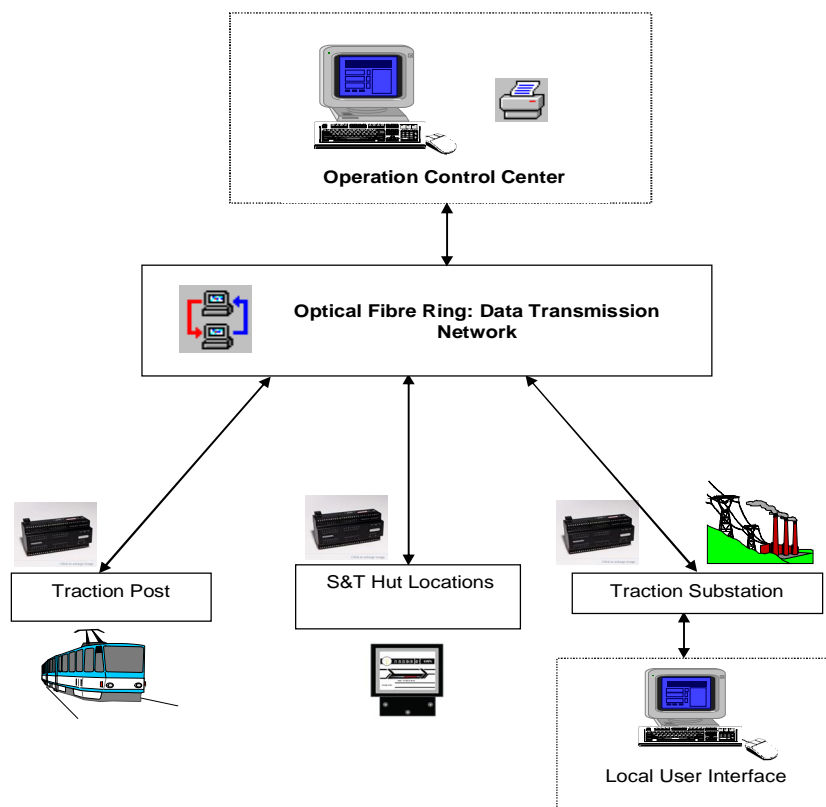

Figure 10.9 - Typical Arrangement of SCADA System for CP- 105 of EDFC

- (7) The SCADA system shall comprise, without limitation to the following:
- a) Operation Control Center (OCC);

- b) Field equipment for Control and Monitoring at Power Supply Installation;
 - c) Data Communication Network .
- (8) The SCADA system provided/augmented by the Contractor (CP-105) shall include as under:
- (1) OCC SCADA equipment
 - a) Communication and Application Server
 - b) Workstations for Control and monitoring, Report generation, Offline data analysis, Engineering, Maintenance and RTU configuration
 - c) Archive and Webserver
 - d) Emulator System for Training
 - e) Network Security and Monitoring System
 - f) Laser Jet and Line printer A3/A4
 - g) Communication and dual LAN equipment
 - h) Mounting brackets, equipment cabinets, racks, installation materials
 - i) Server Room furniture with proper storage for spare material as required
 - j) Power Extension from the UPS (provided by other contractor CP-104), cables, connectors, accessories, cabling and earthing necessary for the works
 - k) Other equipment as necessary to fulfil the requirement
 - l) For OCC theatre equipment, the contractor shall be coordinated with OCC Theatre design contractor and the interface document shall be produced for approval of the Engineer.
 - (9) Field SCADA Equipment
 - a) Remote Terminal Unit (RTU) and associated communication equipment
 - b) Local Interface Unit (LIU) at TSS for Local control
 - c) Cables, connectors, accessories, cabling and earthing necessary for the works
 - d) Portable configuration and Fault Diagnostic device - One number for the OCC.
 - e) Any other works/equipment to fulfil the specified requirement
 - (10) Data Communication Network
 - a) The provision of network within TSS, SSP and OCC shall be in scope of CP-105 Contractor.
 - b) The Contractor) shall establish the communication network from different Power supply installations, to OCC.

10.9.4 CONTROL STRATEGY AND AUTHORIZATION MANAGEMENT

- (1) In addition to above said control possibility, control of power supply equipment shall also be possible from local control panel of equipment, which shall ensure that the traction power supply installation and its protection system shall continue to operate in the event of failure of SCADA system. The following levels of controls should be possible from SCADA system of EDFC
 - (a) Centralized Control
 - (b) Local control mode from TSS for local equipment only: Operation Control Center has to grant "Permission for Local Operation" and all such authorization by Traction Power Controller shall be recorded in event list by SCADA system.
 - (c) Local mode from the equipment: It shall be possible to operate the equipment locally from the control panels by selecting the local / remote selector switch in the Control Panel/equipment. This selection shall be logged in the event list by SCADA system.

Such control shall be only possible after taking "Permission for Local Operation" from the Traction Power Operator. This shall be also logged in event list by SCADA system.
- (2) A control transfer mechanism shall be developed based on above principle and confirming to operation requirement of EDFC and implemented in SCADA system at various control points (Central, Local, Equipment etc.)

10.10 PERFORMANCE SPECIFICATION FOR SCADA SOFTWARE

10.10.1 General

- (1) The software shall be compatible for working on IEC 60870-5-104/OPC UA companion standard protocol based on IEC 60870-5-1 to 5 series of standards. It shall also support multiple channels for communication to all RTUs as per TCP/IP based IEC 60870-5-104/OPC UA communication protocol;
- (2) The software shall fully support data transfers between RTU & OCC as defined by different IEC 60870-5-104 series of standards;
- (3) The software shall give fast response to operator actions and system events. SCADA system stability should be sustained during event bursts. The software should be capable to support system working at high speed data transfer rates achievable over OFC communication networks;
- (4) Software/system performance shall not degrade or drift due to generation of temporary files etc. which the software shall clean/delete automatically;
- (5) Only the valid licensed copies (CD/DVD's) of complete SCADA application, commercial and peripheral software shall be supplied; The firewall /antivirus software provides shall be valid up to the Defect Notification Period(including extended DNP if any);
- (6) SCADA vendor shall provide all necessary run time utilities for successful running of the SCADA application. The utilities supplied by the Contractor along with operating system should be sufficient to independently execute the SCADA software without any problem.

10.10.2 Functional Details of Master Station Software

(1) Acquisition of Measurands

- (a) The SCADA system shall be capable of acquiring measurands i.e. analogue inputs from the TSS including transient values. The measurand data shall be real time stamped/tagged at field level RTU.
- (b) Software shall have capability for Analogue value scaling, processing and conversion to engineering values, limit settings of parameters centrally from OCC or from any Point/ RTU.
- (c) Software shall be fully configurable to analyze the analogue data received from RTU e.g. energy parameters (active, reactive and apparent power & energy), voltage, current and power factor in the form of displays (graphs as well as tabular), trends, alarms to operator in case of set limit violations and historical interpretations.
- (d) Software shall also be able to analyze the transient analogue data for detection of faults and their corrective measures.
- (e) There shall be facility to transfer the data to spreadsheet applications like MS-Excel in .XML formats with User friendly Utility Programme.

(2) Acquisition of Tele-signals

- (a) The software shall support the acquisition of tele-signal (bi-state devices) for each RTU.
- (b) There shall be dependent and independent points in the traction power supply system. For example if a feeder Circuit Breaker Trips, there shall be associated tele-signals for catenary and 240 V AC fail. All such events shall be reported by RTU to OCC with time stamp.

(3) Execution of Tele-commands

- (a) The Software shall be capable of issuing tele-commands to open or close a switching device. All the commands shall follow select – check – execute and report back execution procedure.
- (b) The Tele-commands shall receive the highest priority in conformance to IEC 60870-5-104/OPC UA.
- (c) Operator shall be able to cut off power to a sub-sector by selecting it and giving the command. The system shall open all the associated switching devices automatically in appropriate order with confirmation for each device as an event.
- (d) Option to abort a command shall be available with the operator till it has not been acknowledged for execution at the switching stations. Any command which does not get executed within the specified time as per design, shall be automatically cancelled and confirmation to this effect communicated to operator.
- (e) All the operator commands shall be logged as events. After a control command is issued by the operator, and if the command is not executed, then a message shall be displayed indicating reason(s) for it.
- (f) The Tele-command once selected, if not sent to RTU due to communication

failure or otherwise, shall be aborted after a predefined period of one (1) Second and shall not remain in queue and reported to operator.

(4) Parameter loading to RTU

- (a) The OCC software shall be capable of parameter loading to the RTU in line with IEC 60870-5-104/OPC UA & other basic standards of IEC 60870-5-104/OPC UA series. Some configurable parameters are as under:
 - (i) Dead band for RBE (Report by Exception) of an Analogue value.
 - (ii) Pulse duration of control commands.
 - (iii) Used point of each type in an RTU. (Number of point used of a particular type of point)
 - (iv) Event reporting details which include windows time and de-bouncing time.
- (b) The de-bouncing time, dead band for measurands and the clock synchronization time period shall be settable and so selected that the optimum use of data communication channel is made.

(5) SCADA software configuration

The software shall provide menu driven and user-friendly configuration. The configuration shall define the various devices, their attributes and the traction system specific details. The configuration of the software shall be carried out to cover all details/address/nodes of traction supply operation e.g. Interlocking, locked out signals, protection relays & elements, alarms with attributes, power blocks, parameter settings and display/picture screen properties etc.

(6) Time Synchronization

The master clock installed in OCC shall be used to synchronize the Host computer clock and the clocks of the RTUs.

(7) Test Procedure & Diagnostics

- (a) The software shall support basic test procedure and diagnostic checks for RTU as per IEC 60870-5-104/OPC UA & basic standards of IEC 60870-5 series. As in IEC 60870-5-104/OPC UA, there is no periodic polling for Class1/Class2 event from the master and all events shall be reported by exception from the RTU. The only periodic poll from the master shall be the general interrogation, at intervals not exceeding 10 minutes. Apart from this, master shall send a TESTER packet 10-15 seconds, to check the health of the RTU and communication media.
- (b) SCADA application software shall have minimum following inherent features to check its own sub functions and report status to the operator:
 - (i) Online/standby /offline state of SCADA server/communication front ends.
 - (ii) State of all RTUs.
 - (iii) State of printers.
 - (iv) Connection status of all the operator workstation.
 - (v) Diagnostics shall use standard OS tools to be provided as part of the

administrator tools.

(8) Communication Failures

Time out of the RTU and the cyclic redundancy check (CRC) errors shall be progressively counted and displayed in a tabular report as "Communication failures" for each RTU. The tabular report shall be generated at 4.00 hrs. Every day for the preceding calendar day of 24 hours.

(9) System Security And Access Levels

(a) The system shall provide three security levels for access for different functions:

- (i) Traction Power Controller (TPC): - To view and Control;
- (ii) OCC Engineer – To edit configuration information;
- (iii) System (Admin)/ Engineer- Able to do everything.

(b) The Contractor shall liaise with the Engineer as to which facilities each security level is given. This shall be undertaken in coordination with the Engineer developing the Control Room rule book.

(c) There shall be no remote/email/internet access, user access codes/passwords in the master station software and hardware so that any possibility of a cyber-intrusion or attacks is eliminated. Reasonable precaution, by way of installing fire-wall, and blocking ports for connecting external devices like pen drives, CD drives etc. shall be ensured. This will also be applicable for preventing the access, to manufacturer after the SCADA is handed over or to any employee left the job.

(d) There shall be means to indicate & give alarm in case an intrusion event occurs either through a connection or a peripheral device.

(e) In addition backup and recovery procedures for the SCADA system shall be well defined by the Contractor. The Contractor shall train the Employer's staff on the security threats and vulnerabilities involved with IP based systems.

(f) The Contractor shall provide in OCC, a workstation with a general purpose computer for non SCADA applications. e.g. internet browsing and word processing. The general purpose computer will be connected to the general office LAN and NOT to the SCADA LANs.

(g) **System Users and User Authentication :**

User Access to all functions of system shall follow a consistent set of common user access guidelines. The user access to system, database, and operating systems shall be based on password authentication. Defining and controlling user access to the system shall be provided through independent domain server. The domain server shall be in redundant configurations. A user management application shall be deployed to manage and to help achieve seamless access to all applications after identity authentication of the users.

(10) Manual Input

Facility for marking (manual input) shall be provided for any alarms, equipment status including, measurands and limit-settings, through keyboard.

(11) Status Information

The SCADA system shall be able to display status information for switching station equipment such as device name and its current value/status, scans status (on/off scan), override status and block status shall be displayed.

(12) Breaker Operation Counter

The system shall monitor operation counter of the breakers. The operation counter shall segregate normal operations and fault tripping after analyzing the associated trip relay data. It shall generate alarms after a predefined limit of normal & fault operations is reached. If a pre-determined limit is reached then a maintenance flag shall be sent to the maintenance planning system. The operations counter data shall also be sent to the asset management system at a predetermined time each day.

(13) Block/Un-Block Control For Devices

Facility shall be provided to block / de-block a control point (circuit breaker, interrupter and other controllable equipment or a set of controlled equipment at the controlled station). The block or unblock command shall disable/enable control operations from the OCC. The blocked condition of any equipment or a set of equipment shall be suitably indicated on the monitor.

(14) Boundary Post Operation:

The design shall be such that it shall be possible to provide interlocks between two control centers in future, if required to interlock any equipment or a part of section at the end of its zone of control. For example, when a post separates the zones controlled by two adjacent OCCs, control of breakers/interrupters at this post shall be so arranged that the breakers/interrupters can be closed by one OCC only when an interlock is released from the other OCC. However, opening shall be possible from any of the OCC, in such cases there shall be visual alarm indicating that the opening was initiated by another OCC.

(15) Alarm Processing And Displays:

- (a) Blinking Visual and audio alarms shall get generated whenever the state of device is found to be in the abnormal condition or any measurand's set limit is violated, with facility with the operator to silence the audio part of the alarm and the blinking visual alarm is changed to steady state once for every alarm generation.
- (b) In the event of failure of RTU or any equipment at RCC such as Host or HMI, an equipment alarm shall appear. When both the auxiliary contacts of a device are either in open or in closed condition, such faults shall be detected and identified as "Complementary Faults". Such conditions shall be logged in alarm and event list. The alarm list shall be of two kinds – current and historic.
 - (i) **Current alarm list** shall contain minimum 400 entries. The list shall be ordered chronologically. Acknowledgement status of an alarm shall be indicated in the current alarm list.
 - (ii) **Historical alarms list** shall consist of all alarms for the last one month.
- (c) Operator shall be able to request for display of the alarms in chronological

order starting from any given time. Provision for sorting of historic alarms on various options such as a geographical area, station-wise, Equipment wise or tag wise, and in chronological order shall be supported. Alarm list shall be printable on user's request or downloadable in a format compatible by commercially available spreadsheet software, clearly separating original & consequent alarm such as circuit breaker trip & consequent loss of voltage.

(16) Alarm Acknowledgement

- (a) Page wise facility for alarm acknowledgement with a single click and confirm shall be provided in addition to one by one acknowledgement.
- (b) There shall be facility to define certain alarms with audible sound or pre-recorded voice to attract the attention of the operator as per user requirement.
- (c) There shall be facility for time delayed alarm operation e.g. alarm for tripped capacitor bank circuit breaker closing reminder.
- (d) There shall be a facility to label a post under maintenance & to disable the audio alarm for particular post/ RTU equipment by the operator. For scenarios such as contact chattering, it shall be alarmed as a failure and; visual indication of the discrepancy shall however remain active till its resolution. The list of disabled alarms shall be reported on the daily log each day until the alarm is reinstated.

(17) Events Display

- (a) Events shall be logged separately for all commanded and for unusual un-commanded changes in equipment status, acknowledgement of alarms, limit violations of analogue points, successful and unsuccessful user login and markings done by operator from HMI shall be logged clearly with different heads.
- (b) The event list shall be of two kinds – current and historic, same as explained above and same facilities for sorting, displaying and printing of event reports shall be available.
- (c) Processed alarms: It shall be possible to create processed alarms in the system. For example, There are two events, event A and event B, which are not classified as alarms, however if they occur both together an alarm shall be generated. It shall be possible to apply any Boolean operation or time delay to any number of events to create or process an alarm.
- (d) Searching and sorting: The alarms and event lists shall be fully searchable and sort-able, in a similar fashion to commercially available spreadsheet software.
- (e) Event list security: The list shall be protected by a password & authorization by the Engineer, so that it shall not be possible for any unauthorized operator or person to edit or delete the event lists.
- (f) It shall be possible to view a historical view as a video on the SCADA operator screen.
- (g) Events are listed in chronological Serial order of Occurrence of Events (SOE).

(18) Play Back Feature

- (a) The SCADA software shall have the feature of playback of data (digital and analogue signals) from the historical database. It shall be possible to display the stored data on single line diagram. It shall be possible to configure the time window with the parameters: Start Date, End date, Time of Window, and Sampling Rate for playback.
- (b) The software shall include a feature to differentiate the playback display from the normal displays.
- (c) It shall be possible to generate log files from Play back feature for further Analysis

(19) Tabular Displays

- (a) Tabular displays shall be provided for the following:
 - (i) RTU communication Display
 - (ii) Abnormal summary display – This display will show the points in a station with abnormal status like - off normal status, blocked, manually entered, and not updated
 - (iii) Blocking Summary Display
 - (iv) Tag Summary Display
 - (v) Manual entry summary Display
 - (vi) Operators note summary Display
- (b) From the tabular displays the operator shall be able to locate the point on a single line diagram
- (c) The Tabular Display shall support the following features
 - (i) On line configurable
 - (ii) Multiple data Entry
 - (iii) Sort one or more columns
 - (iv) Filter
 - (v) Sort a filtered list of filter a sorted list
 - (vi) Resizing of columns
 - (vii) Print out the display

(20) Power Block Identification

- (a) Power block for maintenance or inspection shall be granted by the operator / controller in the OCC in pursuance of an approved written down procedure that enables identification of all the authorized and trained personnel granting the block i.e. (the controller of the authorized person requesting the block through a system of passwords & interlocks) and the recipients of the permit to work and precautions to be observed. The Power block shall not be able to be cancelled & section energized unless the permit has been returned by the recipients and the block is cancelled by the person who was granted the block. In case a tele-command is attempted, for energizing the device/ section under block, the command shall be aborted and a hazard

message at the OCC and the RTU shall get generated.

- (b) Granting the power block: The software shall have facility to select the device/section to be brought under power block and kept under power block or to be taken out of power block.
- (c) It shall be possible to select a number of circuit breakers/ Interrupters required to be operated for making a section dead and a group command shall be possible to be issued. The system shall be able to open all devices of the sections, which are put under power block by the operator. The closing operation shall be confirmed for each device as an event. The operator shall be able to modify/create such predefined sequences and save. Such operator created programs shall be available only to the creator and not to the other operators. There shall be a function to allow the system engineer to copy user created programs for other operators.
- (d) Operator shall be able to cut off power to a sub-sector by selecting it and giving and confirming the command. The system shall open all the associated switching devices automatically with confirmation for each device as an event.
- (e) The operator shall have to enter the details of the power block like the operator's code number, and time duration of power block. All power block details like operator's identity, time of imposition and section shall be recorded along with system time.

(21) Cancelling the power block

- (a) Only on authorization of the field supervisor having been granted power block, the operator shall be able to select the device or the section on which the block has to be cancelled and give power block cancellation command. With this the power block of the devices/section shall be removed.
- (b) If a power block is not cancelled at the end of the permitted duration, a suitable alarm shall be generated to attract the attention of the operator. System shall not permit the operator to charge until cancellation of the power block.
- (c) It shall be possible to display or print the information of all power block details giving clear details regarding operator's identity, time of imposition and its cancellation. Power block details shall be stored in the database for later use and the switching events.

(22) Under-voltage tripping of SP Bridging Circuit Breakers

Under extended feed conditions, if a low voltage at SP persists for more than a specified time (both of these shall be configurable), an alarm shall be sent to the operator. If the voltage continues to be in the low range even after this time (i.e. operator has not taken any action within specified time to restore normalcy) then the bridging device shall be opened by the concerned RTU through close loop action on voltage limit violation and shall be implemented using ladder logic or IEC 61131-2 control logic. Any override operation shall be possible only through authentication by an administrative head nominated for the purpose.

(23) Printers

- (a) The SCADA shall be supplied with a minimum of two data-logging laser

printers connected on LAN. The data logging printers shall be in a secure room which the operators have no access to.

- (b) In addition, each operator shall have one laser printer for the production of logs and reports.
- (c) An additional printer shall be provided for the general purpose computer connected to the office LAN.
- (d) The printers shall be laser colour printers of at least A-4 size.

(24) Message Pad

One page shall be provided for the operator to record/add important messages. The messages shall be able to be edited and removed by the operator. The messages shall be retained by the system even if the HMI has been shut down. When the HMI is brought up again, the last entered message shall be viewable by the operator.

(25) Data Logging and Reports Generation

- (a) All alarms and events shall be logged by the system. Average, minimum and maximum values of selected analog parameters shall be stored. The duration of this logging shall be settable and logged data shall be stored automatically with date (year, month and day) and time (hours and minutes) stamp in a file. The software shall be capable of generating different types of reports.
- (b) Some of the reports which may be required are: -
 - (i) Summary of circuit breaker's tripping during a specified period including the relay(s) which caused the tripping;
 - (ii) Power block availed report;
 - (iii) Event and their durations during the month when the voltage went beyond permissible levels at the TSS and SP respectively & parameters of excesses;
 - (iv) Duration during the month when the current exceeded nominal full load capacity of the transformer;
 - (v) Energy data interpretation, Maximum Demand violation;
 - (vi) Morning reports of all the abnormal incidences in the last 24 hours.

(26) Help Functions:

- (a) On-line help and tutoring guide shall be provided for all major functions in the HMI using the HELP option. The help option shall guide the operator for any specific help for carrying out certain tasks.
- (b) A keyboard shortcut shall be provided which can directly take to the current highlighted section help.

(27) Tabular Displays, Current & Historical Trends Diagrams/ Graphs:

- (a) The software shall be capable of providing tabular display of data of a controlled station e.g. equipment status, alarms and measurands.
- (b) The time versus value plot of measurands in a separate colour including the arithmetic values on the measurands such as multiplication shall be

displayed in a trend diagram. The trending shall include both historical trending and dynamic trending of current data.

- (c) The dynamic (current values) trending shall be for duration of one hour. For historical trend, average value of data shall be logged at the interval of 5 min duration.
- (d) It shall be possible to permit the dynamic values in the forms of graphs to an accuracy of 5%.
- (e) It shall be possible to store historical data of 5 years. If required a separate server may be provided at back end to store historical data.
- (f) However all data shall be accessible from the main screen where operator normally watch the recent data.

(28) Switch Over to Hot-Standby Systems:

- (a) Hot standby systems shall be designed / provided to improve the reliability of SCADA system by having back-up machines that automatically take over when the primary fails.
- (b) The standby systems for the main server shall ensure that there will be no loss of data, alarms, event etc. due to the failure of primary server and data shall be updated normally after the failure occurs.

(29) Switch Over of Cold-Standby Systems:

- (a) In the event of failure of primary server, the system shall ensure that the stand by server computer system automatically takes over including the data acquisition and the communication with RTUs over the existing channels. In any case the changeover from main to standby computer shall not take more than 30 sec from the point of view of SCADA system working. The failure of primary server shall be displayed on all HMI's along with suitable alarm indication.
- (b) The system shall be configured on dual Ethernet LAN wherein each computer and server shall have two LAN interfaces. From each computer, one LAN interface shall be connected to first network switch and the second interface to the other switch. After achieving this connectivity, it shall be ensured that any failure of one LAN interface of computer, any one LAN wire, any one LAN switch shall not cause permanent break in LAN connection between any two machines. In any such condition, the system shall be able to restore alternate LAN route within 30 seconds. None of the equipment shall be declared offline/disconnected during LAN failure. Server hot standby switch over shall not be initiated due to a single LAN card failure.

(30) Overall Screen Design & Real Time Display

- (a) The MMI screen of the Work Station shall generally comprise of title bar, menu bar, tool bars, status bars etc. for real time depiction & control of traction power system. This interface shall provide for all interactions between the operator and the SCADA system.
- (b) The MMI shall have features for alerting the operator with audio/visual supports on occurrence of critical alarms and events.

- (c) The audio alarms shall include play back of pre-recorded voice files in .wav or any other standard formats to be agreed by the Engineer. It shall be possible to play different pre-recorded alarms based on criticality of alarm or any other alarm classification.
- (d) Full graphic, colored displays of controlled stations shall be provided by the software. The display shall include ON/OFF status of equipment, (such as feeder CB trip, ac and dc voltage fail/low, RTU fail, communication fail, machine down etc.), alarms, measurands and names of the controlled stations.
- (e) There shall be facility for viewing display of full section, suitably condensed to fit screen size with Zoom in and Zoom out facility. This condensed picture shall be displayed on the MMI when called by the operator. Condensed diagram shall have fewer details as compared to the normal display but operator shall be able to control any of the devices and accept / acknowledge any alarm. The display shall support de-cluttering, zooming and panning through mouse.

(31) Simulator

A Simulator workstation/server set up shall be provided at OCC location with identical replica/snapshots of the actual system available to SCADA Operators for Training on the SCADA system. This setup shall include training Server/Workstation, RTU and necessary Software. Emulator setup shall facilitate the training of operation and maintenance personnel. This system shall support application testing of configuration or parameters modifications, test application modifications. This shall be standalone and receive the data from either the SCADA System or a training RTU fitted with dummy breaker relays, run without disturbing the on-line servers. It shall be possible for the trainer to:

- (a) Create fault scenarios for the trainees;
- (b) Pre-program simulator with timed faults so as to create live like scenarios;
- (c) If the trainer has created an earth fault in any elementary section, then the relevant breakers shall trip. If the trainee tries to charge that section the closing shall be aborted.
- (d) The trainee can learn to identify the fault as he shall be required to find on live system;
- (e) The simulator shall generate alarms and events as it shall generate in a live system;
- (f) The simulator shall not be connected to any RTU (Other than a test RTU) or any other field equipment.
- (g) Grant / cancel Power blocks
- (h) Evaluate performance of trainees
- (i) Training should enable trainees to be able to reconfigure SCADA to include additional RTU or to add additional equipments or add/delete additional I/O features.
- (j) Training shall include creation of HMI mimic, configuration and modification of HMI/Database, parameter change, Alarm and Event configuration, Data

backup.

- (k) Training setup shall provide trainee tools, software used for data preparation, configuration.
- (l) The training shall be different type for Operator, Maintenance, Admin, Viewer etc.
- (m) It shall be possible to test any RTU module and Software/application before deploying in OCC and field.

(32) Safety Tagging

- (a) Tagging facility shall be provided on each item/ equipment for operator to put his comment and inhibit the command for that equipment. After this tag has been enabled, issuing of command shall not be possible from any other operator or other control rooms until this tag have been, over-ridden by the chief SCADA operator. If the chief SCADA operator does override the Inhibit then he shall have to enter his password and this shall be counter signed by the operator who requested the removal of the tag only then shall the tag be removed.
- (b) The tag shall not be lost on system restart or any such scenario.

(33) Database Creation

- (a) Database creation for the complete system shall be possible through Microsoft Excel based tools or similar. Small addition and deletions of I/O points shall be possible online with minimal disturbance to the Operators.
- (b) Complete system restarts shall not be required for such minor operations.

(34) Bus Bar Colouring:

- (a) The SCADA software proposed shall support necessary bus bar colouring feature by which the dynamic status of the bus bar can be depicted during charged and dead (discharged) conditions.
- (b) Earthed equipment, blocked equipment, faulty equipment, faulty status, communication failures shall be displayed in separate colours.
- (c) The coloring shall be provided on all screens (overview / individual or sub-picture) at all times.
- (d) The status change shall be reflected through colour change within 2 seconds on the display.
- (e) It shall be possible to give a specific colour to any section based on an intelligent rule.

(35) Application Programming Interfaces (APIs)

- (a) Since other applications for which interfaces with SCADA data may not have been defined at time of tendering (e.g. Fault Call Management etc.) The SCADA, system shall provide open APIs that can be configured at a later date to suit future interface requirements.
 - (i) Objective Data Base Controller (ODBC) support for data interchange between MS-Windows clients like Excel and the real-time/historical databases.

- (ii) A generic library of services for database access and activation of SCADA procedures and services from external applications.
 - (iii) Support of all APIs in heterogeneous computer environments and to be network transparent.
 - (iv) Standard Utility Protocols as TASE.2 for inter-control center communication.
- (b) A wide range of remote terminal communication protocols for interfacing RTUs and substation control systems from different vendors.

(36) Integrated Graphical & Data Engineering Tool

The integrated graphical & data engineering tool shall provide, as a minimum, following functions:

- (a) Automatic linking of station and network pictures with the SCADA data as part of the data engineering function;
- (b) Support for mass data entry through copy and paste, or excel export import.
- (c) Incremental loading of real-time database.
- (d) Rapid *switch over* to new database without data loss.
- (e) Drag and drop support for linking to data base and pictures.

(37) SCADA Hardware- OCC

- (a) The Contractor shall include the IT hardware specifications in his design for review and approval by Engineer. Industry proven IT hardware shall be used.
- (b) Achieving the performance parameters listed in these specifications shall be the responsibility of the Contractor.
- (c) The following points shall be complied as minimum requirement:
 - (i) Server and workstation hardware shall be platform independent.
 - (ii) Power supply units of the servers, switches, and routers shall be redundant and fed from UPS installed by Other designated System contractor (CP-104) of APL-1;
 - (iii) All monitors of Work station provided shall be minimum 24" LED type. The mouse & keyboard shall be cordless;
 - (iv) All servers and networking equipment shall be rack mountable;
 - (v) Server hard disks shall be in RAID 5 configuration and hot swappable;
 - (vi) As a precaution against security level, USB ports/CD/DVD drives and other removable media shall not be available on operator workstation or shall be suitably disabled such that operator shall not be able to use portable flash or removable media drives on the workstations.
 - (vii) A general office PC shall be provided on each workstation for word processing etc. This shall be connected to the office LAN and can have all of its USB ports and data drives unblocked.

(38) SCADA Hardware-Remote Terminal Unit

a) General

As a minimum, the RTU shall support the following;

- (i) Remote Terminal Unit (RTU) shall be installed at the TSS, SSPs, and ATS. It serves as interface between switching stations (the TSS, SSP and ATS) and master station (OCC); RTU for SSP shall be interchangeable.
- (ii) RTU shall be able to perform both data acquisition and local data processing. In the case of a communication path failure, the RTU shall operate as an independent intelligent unit and acquire and store data without interruption. On resumption of normal communication, the data shall be transmitted to the SCADA system;
- (iii) The RTU shall support remote programming facility using RTU programming utility software from the master control Centre. A port on the RTU shall be dedicated to the master control Centre via one separate non redundant Ethernet communication channel;
- (iv) The RTU shall be capable of communicating over IEC60870-5-104 with Control Center, IEC 61850 for interface with Relays, BCU, IEDs; IEC 60870-5-103 for interface with protection equipment; Modbus protocol for communication with Energy and Multifunction meters on Ethernet communication with Intruder Detection system and Access Control System.
- (v) In case of failure of communication between control posts and OCC/BCC, the local protective relays shall continue to function with all their protective features, including the lock out features on a persistent fault. All information in regard to the occurrence including data shall be stored in the RTU end for up to at least 1000 events and shall be transmitted the OCC on resumption of normalcy.
- (vi) RTU shall continue to operate all safety features during failure of SCADA channel to OCC.
- (vii) The RTU shall be capable to handle analogue input, digital input, and control output signals.
- (viii) For each traction power supply Control post, the RTU shall be equipped to handle all the I/O points as required. In addition, the RTU shall include fully configured spare I/O points (Minimum 10% in each type of card) available for the Employer's use; The RTU for a TSS without any standby transformer should allow addition of standby transformer and associated equipment.
- (ix) The RTU shall have an internal clock for data collecting coordination and time tagging. The internal clock shall be completely independent of the synchronization source so that the RTU shall continue to properly handle its time related application in case of source and communication failure.
- (x) RTU shall support maximum demand (apparent power) calculation based on 5 to 30 minutes window periods based on inputs received

from energy/power transducers similar to that of Power Utilities matched with time clock. The value of Maximum Demand (MD) shall be reported to OCC after each window period;

- (xi) It shall be possible to reset the CPU of RTU from OCC in case it hangs due to any reason;
- (xii) High-resolution sequence-of-events (SOE) processing and reporting capability shall be as follows;
 - i. Detect changes in the state of SOE points;
 - ii. Record the date and time of change with a resolution of ± 1 ms;
 - iii. Ability to retransmit stored SOE data if requested by the system Master Station in order to ensure that SOE data are neither lost nor overwritten until the RTU acknowledges the receipt of the data. A buffer capable of storing at least 1024 events shall be provided;
- (xiii) Ability to communicate with the local user interface (LUI) for control & Monitoring / maintenance purposes in case of communication link failure with OCC;
- (xiv) It shall be possible to increase the number of communication ports in the RTU by addition of suitable cards, if required in future;
- (xv) It shall be possible to mount the IO modules and the processor/ communication modules in the same rack of RTU.
- (xvi) RTU software shall be capable of being reconfigured (under password control) locally from the laptop/portable programming device and from the central master station by using IP based RTU maintenance software. Contractor shall furnish authentic copies of RTU software in CD/DVD;
- (xvii) The RTU shall have self-monitoring/diagnostic for fault conditions. This shall provide various details such as status of ROM, data bus, RAM check, battery low, defective cards etc. The RTU should generally support the test procedures as per standard protocol IEC 60870-5-101 & 104/OPC UA;
- (xviii) The RTU address shall be configurable. The RTU address shall not be lost in case of power swings or surges. It shall be possible for the Employers' Staff to reconfigure the address for the remote station.
- (xix) In case additional RTUs are to be configured, configuration manual shall be provided by the Contractor and the Employer's Staff should be trained to configure additional RTUs as and when required.

(39) RTU Cabinets

- (a) The RTU installations shall be dust, rodent and vermin proof with doors. The doors shall have proper rubber gaskets & locking arrangement. The cabinets shall have facility for bottom/top entry of incoming/outgoing cables for operation of the equipment. The Cabinet shall be manufactured from CRCA sheet of Minimum Thickness of 1.6mm (with Door of minimum thickness of 2.0mm), Passivized, cured and acceptable quality treatment,

powder coated and painted so as to make the surfaces rust and scratchproof quality. Suitable reinforcements shall be provided wherever necessary.

- (b) The RTU shall be floor mounted. The Contractor shall offer as small cabinet as possible without compromising on maintainability and serviceability of the RTU equipment. There shall preferably be only one RTU cabinet housing all equipment. All RTU enclosures located indoor shall conform to minimum Ingress protection class IP 54 as per IEC 60529. All enclosures located outdoor/ open/under shade shall conform to minimum Ingress protection class IP 65 as per IEC 60529. The interior of the panel shall be lit on opening, using a CFL/LED lamp by a door controlled switch.
- (c) Modular type of construction shall be adopted to facilitate unit replacement of devices wherever required. Surface mounted technology or better (SMT) shall be used for higher level of reliability. Standard plug-in and connector arrangement shall be made for the printed cards.

(40) RTU Wiring

- (a) All internal RTU control circuits and wiring of DI/DO & other signal circuits between C & R panel and RTU shall be with at least 0.75 sq mm, 1100 V AC / 1500V DC grade PVC insulated copper conductors conforming to IS 694.
- (b) RTU shall be wired with 1.5 sq mm XLPE insulated copper conductors conforming to IS 7098, 1100V ac/ 1500Vdc grade (screened wherever necessary) only for main incoming 110Vdc & 240 V ac power supply (4 sq mm only for CT wiring).
- (c) Harnesses of wires/cables shall be neatly dressed, laid in metallic and supported suitably. Separate wire bunches shall be run for ac, dc, control and data circuits. Caution plates and name labels shall be provided in keeping with good engineering practice.

(41) RTU Software

- (a) The term "RTU software" used in this Particular Specification means software used at RTU generally implemented through firmware. All Software shall be implemented according to the Contractor's established design and coding standards. Complete and comprehensive documentation shall be provided for all software to the extent that it is used in any way to configure or manage the system.
- (b) The RTU software shall provide automatic restart of the RTU upon power restoration, memory parity errors, hardware failures, and manual request. It shall initialize the RTU and begin execution of the RTU functions without intervention by the OCC. All restarts shall be reported to the system Master Station.
- (c) In order to provide for easy upgrading and/or correction, the RTU software shall be stored on a removable flash memory card. In addition, it is required for the RTU to perform the following tasks remotely:
- (d) RTU software and database maintenance;
- (e) RTU diagnostics;

- (f) Configuration of RTU parameters and programmable logic functions;
- (g) The RTU software shall also support an easy, user-friendly human interface enabling an authorized operator to perform local supervision, control and/or maintenance of the RTU. There shall be a context sensitive interactive help window, e.g., a pop up text window displaying relevant help information.
- (h) The System Functions to be supported by the RTU Software shall be as follows:
 - (i) Equipment control;
 - (j) Equipment indications;
 - (k) Equipment alarm and event handling facilities;
 - (l) System configuration and database maintenance;
 - (m) Manual and automatic control function configuration;
 - (n) Protocol management;
 - (o) Measurement values and computations;
 - (p) Automatic self-diagnostic;
 - (q) Help information;
 - (r) Archiving.

(42) Local User Interface (LUI), Only for TSS RTU

- (a) The RTU shall support a LUI for use by the Employer's staff and shall allow local operation.
- (b) As a minimum, the LUI shall perform the following functions:
 - (i) View remote station data and alarm information on graphical and tabular displays. This function shall include one-line diagram displays of the associated substation for viewing dynamically updating data and alarms.
 - (ii) Initiate control actions, such as opening and closing circuit breakers. This function shall operate on a Select-Check-back-Before-Operate (SCBO) basis, and shall include appropriate security to prevent inadvertent and unauthorized control actions.
 - (iii) Store historical information such as alarms, events and analog measurement.
 - (iv) Maintain LUI and RTU software, database, and displays.
 - (v) Execute LUI and RTU diagnostic programs. The diagnostic programs are installed in the RTU-Software, thus no special installation shall be necessary on the computers/laptops used to present the LUI.
 - (vi) Configure RTU system parameters.
 - (vii) Configure RTU programmable logic functions.
 - (viii) Control functions at LUI shall be enabled only when specially granted by OCC.

(43) RTU Environment Conditions:

- (a) RTUs shall be subjected to severe temperature variations and vibration conditions produced by moving rolling stock. The amplitude of these vibrations is expected to be in the range of 30 to 150 microns, with rapidly varying time periods in the range of 15 to 70 ms and occasional peaks of 350 microns.
- (b) The track side cubicles shall not be air-conditioned and are liable for exposure to polluted, dusty and corrosive atmosphere. The environmental conditions are given in clause 4.2. The RTU hardware shall be immune to electromagnetic interference from nearby high current electrical equipment, to ensure safe and reliable operation under all loads and faults. Electromagnetic compatibility (EMC) shall meet the requirements of relevant international standards.

(44) Protection Against Surges

- (a) The power supply unit/DC-DC converter of RTU shall have internal protections against under voltage, over voltage, overload and short circuits in addition to adequate protection against surges and lightning in compliance of IEC-61643-12, 61312 & 61024 and DIN VDE-0100-534 as applicable.
- (b) In signaling line surge protection device of class D type shall be provided as per IEC 61643-21 & DIN VDE 0675 Pt. 6.

(45) Earths/ Earth Stations

- (a) Contractor shall provide a separate maintenance free low resistance (<1 ohm) Clean earth station for RTUs and SCADA system. The RTU body/frame shall be suitably connected to the separate earth.
- (b) Overall responsibility to ensure suitable design of RTU earthing arrangement to avoid failures of electronic cards etc. in RTU shall be that of the Contractor.

(46) Electrical Protection for Power Supply

The Contractor shall ensure proper electrical protection by providing MCBs. There shall be one MCB per supply circuit.

(47) Redundancy

- (a) The Power supply cards for the RTU system shall work in (1+1) hot standby mode. Failure of one supply card and its switchover to the standby card shall not cause any interruption to the functioning of SCADA. All failures shall be recorded as an event and stamped with date and time.
- (b) The RTU shall communicate with the Master SCADA server through redundant communication channels. The RTU communication cards and the server shall be accordingly configured. Redundant data channel of adequate bandwidth shall be provided by the contractor.
- (c) Processing Cards for the RTU shall be provided in (1+1) hot standby mode. Switchover from main to standby, card shall be transparent to the system functioning i.e. there will be no loss of function during the changeover period.

(48) PLC Programming Facility:

To enable programming for logic functions as required for the traction power supply distribution application, the RTUs shall support PLC in compliance with IEC 61131-3. The required programming tool shall be within the scope of the work.

(49) Time Synchronization in RTU

The RTUs shall be time synchronized with the master Clock. Further the RTU shall support the following methods of synchronization:

- (a) Time synchronization of the RTU by the network control Centre(NCC) via a periodically transmitted synchronization instruction with a communication protocol supporting this function
- (b) Time synchronization of the RTU using SNTP on a LAN network

(50) Cyber Security Features

RTU shall be capable of User activity logging and role based account management with password complexities based on at least one character options.

(51) Central Processing and Communication Unit:

The Central processing unit shall employ at least a 32 bit microprocessor and a dedicated peripheral bus controller for handling IO functions and adequate RAM - flash memory and high processing power. Features shall be identical in the redundant CPU. The CPU module shall have nonvolatile memory. The CPU module shall support the following Ethernet and serial port requirements in one or more CPU modules;

- (a) It shall have necessary communication ports for communication with at least 2 control centers i.e. one main control Centre and one back up control Centre on IEC 870-5-104 protocol. Also the RTU shall be capable of communication with maximum of 8 masters.
- (b) It shall support data acquisition from energy meters.
- (c) The Central RTU shall include minimum of 4 serial ports using RS232/RS485 interface and 2 Ethernet ports to communicate with IEDs by using the IEC61850/IEC60870-5-103/DNP 3.0 protocol. The Ethernet ports in the communication modules shall be of 100 Mbps.
- (d) The RTU shall have one MMI port which may also be used for configuration purpose.

(52) Analog Input

- (a) The analogue inputs module shall have minimum 8 channels per module and shall support dual slope integration A/D conversion.
- (b) The RTU analogue-to-digital (A/D) converters shall have a digital resolution of at least 11 bits plus sign.
- (c) The analogue module shall support the following signal :
 - (i) Unipolar Measured Values
 - (ii) Bipolar Measured values
- (d) It shall be configured for the following measurement ranges:

- (i) 0 - 2.5 mA
- (ii) 0 - 5.0 mA
- (iii) 0 - 10 mA
- (iv) 0 - 20 mA
- (v) 4 - 20 mA
- (vi) 0 - 1.0V DC
- (vii) 0 – 10 V DC

The accuracy shall be better than $\pm 0.1\%$ on full scale.

- (e) Following Programmable parameters shall be supported:
 - (i) Live zero conversion coefficient Cyclic;
 - (ii) Transmission or threshold value Forced;
 - (iii) zero point conversion coefficient Limit;
 - (iv) Values Smoothing factor Threshold;
 - (v) Values Cyclic duration;
 - (vi) Priority of transmission.
- (f) Other parameters:
 - (i) Inputs shall be configurable for 4 to 20 mA / bipolar or live zero
 - (ii) Accuracy- $\leq 0.25\%$
 - (iii) Common Mode Voltage : ± 8 V DC
 - (iv) Line Interference suppression : > 100 d for $f = 50$ Hz

(53) Transducers:

- (a) The independent transducers converter/ multi-function transducers (MFT) required for acquiring Analogue inputs from CT/PT shall be supplied by the Contractor.
- (b) The transducers shall be selected for nominal 110 V ac (Ph-Ground voltage) and 1A/5A CT/PT inputs. The transducers shall withstand input voltages up to 120% of the nominal voltage and shall be suitable for 20% continuous over load and 20 times the normal current rating for a period of one second.
- (c) Transducers shall provide at least the following parameters as a minimum with the specified accuracies.

Sl. No.	Parameters	Accuracy
(i)	Voltage (Each phase to neutral and phase to phase)	$\pm 0.5\%$
(ii)	Current (each phase)	$\pm 0.5\%$
(iii)	Active Power, Reactive power, Apparent Power	$\pm 0.5\% / \pm 1\%$
(iv)	Import & Export Energy (active/reactive)	$\pm 1\% / \pm 2\%$
(v)	Power Factor (measuring range)	0.5 lag to 0.5 lead

Sl. No.	Parameters	Accuracy
(vi)	Auxiliary Power supply	110 V dc

- (d) Temperature and pressure monitoring transducers shall be similarly rated and provided with the independent power supply drawn from local LT supply.

(54) Digital Input Module:

- (a) The Digital input module shall have at least 16 optically isolated channels per module and shall support time stamping with time resolution of 1 Ms. The digital input module shall support configuration of inputs for the following options:
- (i) Single Indications
 - (ii) Double Indications
 - (iii) Digital Measurands
- (b) The digital input module shall also support the programmable parameters including but not limited to:
- (i) Bounce Filter (Suppression Time);
 - (ii) Settling time for reliable digital measured value;
 - (iii) Chatter suppression;
 - (iv) Suppression of intermediate position;
 - (v) With / without time tagging shall be a configurable feature;
 - (vi) Configurability of message transmission priority.
 - (vii) Indication processing
- (c) Group or Common alarms shall be configurable from Individual alarms by Boolean operations;
- (d) Acquisition of events in chronological order with a time resolution of 1 ms - Buffering up to 3 changes per input.

(55) Digital Output

- (a) The Digital Output module shall support at least 16 digital output channels per module. The output module shall support time stamping with time resolution of 1ms and shall support following Programmable Parameters which shall include:
- (i) Duration of output pulse
 - (ii) Release disconnection delay time at response indications
 - (iii) Select before execute
 - (iv) Cyclic duration
 - (v) Priority of transmission
- (b) Interposing contactors/relays for operating the closing and tripping circuits shall form part of the SCADA equipment. The contactors/relays shall be suitable for 110 V dc supply varying from + 10 % to -20 %. The contacts of

relays shall have a continuous current carrying capacity of 5 A, making capacity of minimum 10 A and breaking capacity of 2 A inductive load. Suitable spark quenching circuit shall be provided to take care of breaking inductive loads.

(56) Network Management System (at OCC)

- (a) SCADA contractor shall provide Network management system to facilitate following activities:
 - (i) Security Management to protect system and network from unauthorized access, manage user access, authorizing privileges.
 - (ii) Inventory Management to collect information such as processors, memory, peripherals and processes running of computers/any processor based equipment in SCADA system.
 - (iii) Performance Management to monitor system and network performance as specified.
 - (iv) Fault Management to recognize, isolate, log and identify fault on network and connected machines, nodes, devices.
- (b) The NMS system shall have a simple browser based user interface to provide all the pertinent information about the system. The NMS shall not impact the availability and performance of SCADA.
- (c) The Network management system shall monitor the performance, resource usages and error statistics of all the servers, workstations, routers and switches including the following,
 - 1. Utilization (CPU and/or channel time being used as applicable) for
 - (i) Servers, Workstations, Storage Devices
 - (ii) LAN, Router, Switches, Firewall
 - (iii) Data Links
 - 2. Memory utilization, Auxiliary memory I/O utilization of
 - (i) Servers and Other Machines
 - (ii) Mass Storage Devices
- (d) The Network Management Software shall,
 - (i) Maintain performance, resource usage & error statistics and present this information via displays, periodic reports, and on demand reports. Apart from real-time monitoring, the above information shall be collected and stored at user configurable periodicities i.e. 5 minutes to 60 minutes.
 - (ii) Maintain a graphical display for connectivity and status of servers and peripheral devices for local area network.
 - (iii) Issue alarms when error conditions or resource usage problems occur.
 - (iv) The period over which the statistics are gathered shall be adjustable by the user, and the accumulated statistics shall be reset at the start of each period.

- (v) The statistics shall be available for printout and display after each period and on demand during the period.
- (vi) The user interface provision shall be made in OCC.

10.11 TESTING, COMMISSIONING AND VERIFICATION

10.11.1 General

- (a) Tests shall be performed in accordance with Chapter 8 –Supply, Installation, Testing and Commissioning of Employer's Requirements General Specifications.
- (b) The Contractor shall develop a full test plan including integrated test and commissioning and performance verification and submit for review by the Engineer at least one month before any on site tests are to be performed.
- (c) On receipt of no objection by the Engineer the onsite tests as indicated therein shall be performed. The tests mentioned herein are indicative and minimum requirement.
- (d) Test Certificates

Six sets of all principal test records and test certificates duly endorsed by the Contractor are to be submitted for the review by the Engineer in accordance with the specifications relating to the item, component or equipment. These test records and certificates shall be supplied for all tests, whether or not the Engineer has witnessed them. The information given on such test certificates shall be sufficient to identify the materials or equipment to which the certificate refers.

10.11.2 Testing of SCADA System

(1) Type Tests and Factory Acceptance Tests

- (a) Complete SCADA system shall be offered for factory acceptance tests before dispatch. These tests shall as a minimum comprise of but not limited to the following:
 - (i) Communication Protocol Test: All the important services as per IEC 60870-5-104 and 61850 shall be verified. Vendor shall also supply the necessary test certificates issued from reputed testing agencies for IEC 60870-5-104 and 61850 compliance for the complete SCADA system;
 - (ii) The Master station with RTU simulator tool shall be used to test the communication interfaces of Master station, RTU and Protection relays. The Master station simulator tool shall be capable of emulating the master station for IEC 60870-5-104/OPC UA and IEC 60870-5-103 protocols.
 - (iii) The RTU shall be interfaced with Energy meters on Modbus protocol and displayed with measurands at OCC end in SCADA Single line Diagram.
 - (iv) The RTU simulator shall be capable of emulating the slave protocols for both the IEC 60870-5-104/OPC UA, and IEC 60870-5-103 protocols for Protection relays. It shall also be possible to transmit illegal messages, such as messages having invalid checksum;

- (v) The protocol analyzer shall be used to monitor all communication traffic on a channel (between Master station & RTU and between RTU & protection relays) without interfering channels operation. Channel traffic captured in the active or passive modes of operation shall be displayed;
- (vi) The Master station simulator and protocol analyzer tool shall also have following features:
 - (a) Each received message shall be checked for validity, including the check sum.
 - (b) The tool shall maintain and display error counters so that the number of errors during a period of unattended testing can be determined.
 - (c) All fields of a message shall be displayed. A pass/fail indication for the message shall be included.
- (vii) RTU functionality Test:
 - (a) Visual Examination: RTUs shall be inspected for the features indicated in the specification and the approved Drawings.
 - (b) Detailed Architecture and features: Verification of design requirements as stipulated;
 - (c) Functional testing on all communication devices including media converters, LAN equipment etc. shall be carried out to verify their operational parameters;
 - (d) Transducers accuracy shall be verified over the entire range for linearity and accuracy;
 - (e) Functional tests shall be conducted on the power supply unit
 - (i) Stability of output voltages with the variation of input DC (94-121V) voltage;
 - (ii) With 120% of the normal designed rated load, the voltage regulation and the ripple factor.
 - (f) Insulation resistance Tests: Insulation resistance of cables shall be checked without connecting electronic circuits between various circuits, contacts, and terminals with a 500 V Megger. It shall not be less than 5 mega Ohms.
 - (i) SCADA Software functionality tests:**
 - (a) All SCADA Software functional features mentioned in this specifications shall be verified,
 - (b) Sample SLD's for one station of each type shall be made available and verified for look and feel, ergonomics, and symbols used, interlinking of various Pictures and operation mechanisms, alarm & event log with <1ms resolution,
 - (c) Command execution time verification with minimum four online RTU's.
 - (d) Status updates time verification with minimum four online RTU's.

- (e) Bus bar coloration performance verification. With minimum four online RTU's.
- (f) Verification of various authorization levels and password protections in the system.
- (g) hot and standby switchover, self-check and diagnostic features etc. shall be verified,
- (h) PC/Servers/Printers for OCC etc. shall be checked as per approved Drawings.

10.11.3 Environment and EMI Test on RTU

- (1) The following tests shall be conducted on the offered RTU sub assemblies (cards/modules) or reports of type tests carried out at Government test labs/institutions/NABL accredited testing labs or any other lab acceptable to Engineer shall be produced.

Sr. No.	Title	Standard No.
1	High Frequency test	IEC 60255-22-1, class – III Frequency : 1MHz Damped Oscillatory Longitudinal :5 kVp Duration: 2 sec. Between input current Terminals
2	Electrostatic discharge Direct application and Indirect application	IEC 60255-22-2 Class III and IEC 61000-4-2 class III. Contact discharge: 6kV, Air discharge: 8kV Polarity: both +ve and –ve polarities. IEC-61000-4-2, Class-III
3	Fast transient disturbance	IEC 60255-22-4 and IEC 61000-4-4, class A 1.2kV; 5/50ns; 5kHz burst duration = 15ms. Repetition rate 300ms; Both polarities; Ri = 50Ω; duration 1 min.
4	Surge immunity test	IEC 60255-22-5 / IEC 61000-4-6 class 4 Differential Mode = 2kV Common Mode = 4kV 1.2/50uS , 5 surges of each polarity
5	Power frequency immunity test	IEC 60255-22-7, Class-A
6	Power frequency	IEC 61000-4-8, Class-V
7	Radiated electromagnetic field disturbance	IEC 60255-22-3 EN 61000-4-3 Frequency 80MHz – 1GHz
8	Conducted Disturbance induced by Radio Frequency field	IEC 60255-22-6 / IEC 61000-4-6: 1996. Freq. 150kHz – 80MHz, Amplitude 10 V, : Modulation 80% AM @ 1 kHz
9	AC Ripple in DC supply Test	: IEC 60255-11
10	Radiated emission:	: IEC 60255-25
11	Dry heat test at 70 ⁰ C in operational condition for 96 Hours.	

Sr. No.	Title	Standard No.
12	Damp heat test at 40 ⁰ C and 95 % RH in operational condition for 10 hours.	
13	Cold test at 0 ⁰ C operational condition for 16 Hours.	
14	Cyclic heat test at high temperature at 50 ⁰ C and low temperature at - 2.5 ⁰ C; Dwell time in high or low temperature for 3 Hours. Transition of 10 ⁰ C per minute, and for 5 such cycles in operational condition.	

- (2) The vibration test specified as under shall be conducted on the complete assembled.
- (3) Vibration test with severity of weight centered endurance by sweep frequency 10-50 Hz, displacement of 0.15 mm acceleration of 2 g and of duration of 2 Hours in each axis. (Total 6 Hours).

10.11.4 Site Acceptance Tests

- (1) Tests shall be carried out during erection/commissioning of the equipment at site on the complete system in the presence of the Engineer to check the proper erection and successful commissioning of the equipment. These tests shall be carried out to check the compliance of the SCADA system with the stipulations made in the specification Drawings.
- (2) SCAN time, cyclic update time and command operation time shall be measured.
- (3) Complete SCADA system working after full configuration shall be verified.
- (4) System response to abnormal conditions shall be verified.
- (5) Site tests shall include tests with different types of simulated faults and with different values of measured parameters. The tests proposed to be performed for this shall also form part of Test Plan to be submitted as per clause 10.11.1 (b).

(End of Chapter 10)

CHAPTER 11 - INSTALLATION

11.1 GENERAL REQUIREMENTS

- 11.1.1 The Contractor shall comply with all Enactments in executing the Works, including but not limited to all statutory provisions on occupational health, safety and environment.
- 11.1.2 The Contractor shall co-ordinate with Other Contractors in the execution of the Works.
- 11.1.3 The Contractor shall also co-operate with all Relevant Authorities in the execution of the Works.
- 11.1.4 The Contractor shall mobilise a team of competent professionals whose CV shall be approved by The Engineer. The installation of all equipment shall be undertaken at all times by suitably trained and competent employees with previous experience of similar work of the Contractor, to the satisfaction of the Engineer. The Engineer/ The employer reserve the right to seek replacement if not satisfied with the qualification of any Professional.
- 11.1.5 Only appropriate tools, plant, equipment and vehicles shall be used. The Engineer reserves the right to prohibit the use of particular tools and vehicles.
- 11.1.6 Installation of all equipment shall be in accordance with the Construction and Installation Plan described in Chapter 8 of the General Specifications.
- 11.1.7 Installation of all equipment shall conform to the best industry practices.
- 11.1.8 Precautions shall be undertaken to ensure the safety of personnel and equipment for all installation works.
- 11.1.9 The Contractor shall, prior to starting any installation work, identify any possible hazards, and implement measures of eliminating and/or controlling such potential hazards, in line with safe working practices. These hazards shall be clearly identified in a hazard log that is included in the method statement. These hazards shall be briefed to all site staff at the beginning of each shift. All site staff will sign the briefing sheet.
- 11.1.10 The details on Site safety management are described in the GS.
- 11.1.11 The Contractor shall ensure that all areas of work are sufficiently illuminated for the works to be undertaken and that a safe system of work is employed for all activities.
- 11.1.12 The Contractor shall operate a robust system for the control of persons entering or working upon the site. The system shall include as a minimum:
- (1) Register of all employees;
 - (2) Personal identification, with photograph;
 - (3) Levels of competency;
 - (4) Date of expiry;
 - (5) Date of issue;
 - (6) Signature; and
 - (7) Register of all visitors.
- The site identity pass shall incorporate measure to ensure that the pass cannot be easily counterfeited, forged or copied.

- 11.1.13 The Contractor shall co-operate, at all times, with the Engineer and Other Contractors to ensure that the Site is protected from unauthorized admission, either wilfully or otherwise.
- 11.1.14 The Contractor shall make due provision for the safe access and egress to the Site of Works for its staff and subcontractors. This access shall be maintained such that it is free of all hazards and is in a safe condition throughout the duration of the Works.

11.2 SPECIFIC REQUIREMENTS

The installation work pertaining to this Contract shall include, but not be limited to the following: -

- (1) Finalization of the Construction and Installation Programme;
- (2) Survey on Site and review the technical requirements shown in this Specifications and the Employer's Drawings;
- (3) Production of the calculation sheets and installation Drawings for Site installation;
- (4) Installation in accordance with the finalized installation Drawings;
- (5) Co-ordination with Other Contractors;
- (6) Submission of the installation reports and records;
- (7) Testing and commissioning, as per finalized protocol and programme.
- (8) Production of as built Drawings, documents, calculation sheets, and records.

11.3 CONSTRUCTION AND INSTALLATION PLAN

- 11.3.1 The Contractor shall undertake installation work in stages as shown in the detailed installation programme. Installation, testing and commissioning of later stages shall not impact revenue operation of earlier stages.
- 11.3.2 As a minimum, the detailed Construction and Installation Plan shall include but not be limited to the activities described above and in GS Vol. I – Chapter 8 on Supply, installation, testing and commissioning. Details of all activities related to installation, methods of installation, equipment, vehicles and tools to be used, safety issues considered supervision and skilled staff to be used for the activity shall be elaborated.

11.4 MATERIAL HANDLING

- 11.4.1 To provide for handling of consignments during construction and also needed during the life of the installation, the contractor shall provide a suitable means or an unloading gantry with a manually operated Chain Pulley hoist of Suitable rating (tonnage) on an unloading platform having the road approach of the switch yard in each Traction Substation as a part of the Permanent Works by Contractor (CP-105).
- 11.4.2 The Contract shall provide the approach roads inside the Power supply Control Posts TSS, SSP suited for carrying equipment of highest weight like transformer.
- 11.4.3 The Unloading platform constructed by the Contractor shall also be of same application duty requirement as the heaviest equipment may be unloaded at such platform including for maintenance if any.
- 11.4.4 The Contractor shall have their own means to shift the material to the worksite including

the transportation vehicle and the approach Road connecting to TSS/SSP and ATS (if any).

11.5 MATERIAL HANDLING PLAN FOR EQUIPMENT

11.5.1 The Contractor shall prepare a material handling plan for TSS, SSP and ATS (if any) for movement and installation of bulky items such as transformers, 132kV& 25kV switchgear and OHE Masts, contact wire and catenary wire and other bulky material.

11.5.2 The Contractor shall comply with the requirements specified in the GS (General Specifications) in relation to the use of works sites allocated to the Contractor.

11.6 WORKS TRAIN

11.6.1 The Contractor shall provide sets of High Output Work Trains for construction of the OHE. The sets of Work trains should be adequate to commence and continue works simultaneously on all the sections of work pertaining to the Contractor for Civil and track work (CST 302) as soon as the Track / access to the portions of work site of each of the two contracts is available. These work trains shall include mast erectors, mast transport, wiring trains with platforms for fixing wires and installing droppers, and instrumentation for expeditious progress.

11.6.2 For the use of any Works Train, the Contractor shall ensure its safe loading, adequate steps taken against shifting while in motion and ensure that the dimensions of materials and/or equipment carried under no circumstance shall infringe the Schedule of moving dimensions stipulated for the Eastern Dedicated Freight Corridor.

11.6.3 The Contractor is advised to carefully consider the Works Train design so that the working platforms have the flexibility to enable the train to pass the height restriction and yet be of sufficient height for safe and efficient installation of the OHE when on Site.

11.7 INSTALLATION OF CABLES

11.7.1 The Contractor shall co-ordinate with the CST Contractors for the installation of cables in cable trenches, ducts, troughs, risers and under track crossings.

11.7.2 All the cables laid in the TSS/SSP shall be laid in Covered Masonry/ RCC trenches as per relevant standards however at stations or in City/ Municipal/ Local Bodies, the cables may be required to be laid buried under ground. Directly Buried cables shall be laid/organised as per IS 1255. The Buried cables shall be protected against mechanical damage and water absorption.

11.7.3 Cables laid in the trenches shall conform to IEC 61537, IEEE 525. The Cable containment and support system shall conform to IEC 61537.

11.7.4 The cable system shall, during installation, be fully protected from mechanical damage and be generally accessible at all points for inspection along its entire route as per IS 1255.

11.7.5 Suitable cable markers shall be provided for covered cables upon completion of installation.

11.7.6 Should it prove necessary to cut any cable during installation, all cut ends shall be properly sealed until use.

11.7.7 The maximum pulling force of any cable during installation shall not exceed the

- manufactures recommended design force of the cables.
- 11.7.8 The Pull pits shall be provided for directly buried cables, laid in Pipes.
- 11.7.9 All cables shall be laid and suitably clamped in the cable trenches, and for the shafts, under track crossings, hangers, trays and brackets.
- 11.7.10 The minimum manufacturer's recommended bending radius of the cables shall not be exceeded during installation.
- 11.7.11 All materials used for termination, jointing and installation of cables in confined spaces shall have flame retardant, low smoke, halogen free characteristics.
- 11.7.12 Cable joints and terminations should comply with EN 60502, EN 60840 as per the insulation class.
- 11.7.13 The Cable containment and cable sizing designs shall be revalidated with the spacing of cables laid and the cable containment finally executed and suitably corrected for better cable life.

(End of Chapter 11)

CHAPTER 12 - TESTING, COMMISSIONING AND HANDING OVER / TAKE OVER

12.1 GENERAL

Tests shall be performed in accordance with Employer's Requirements, Part 2, Section VI, Vol-1, Chapter 8 - Supply, Installation, Testing and Commissioning of General Specifications. In addition, the cost of inspection charges of 3rd party, engaged by the Employer (DFCC), shall be borne by the Employer (DFCC).

12.2 CONTRACTORS RESPONSIBILITIES FOR ON-SITE TESTING

The contractor shall submit Test Plan for Total system as well as for different subsystems (TSS, SSP, OHE, SCADA etc.) and major equipment (Switchgear, Transformer, Cables, Control Panels, Distribution Board, Battery and its charger, Isolator etc.) in accordance with:

- (i) Relevant Indian / International standards;
- (ii) Tests as given in the applicable Standards for equipment / Subsystem;
- (iii) Manufacturer's recommendations for tests after installation.

The Test Plans shall include the items as described in relevant Chapter of this PS. The tests shall be conducted after the test plans have been approved. Record of such tests with observations and obtained result shall be maintained.

12.2.1 Traction Power Energization of the track shall be carried out progressively in stages. For the energization of section in stages, sectional turn-on of 25 kV AC power may require putting up of temporary works e.g. cable diversion, additional earthing provision, etc. to ensure the safety of workers working in the adjacent area. Such work inclusive of sectional testing of traction power shall be deemed to be included in the scope of Contract. The OHE commissioning shall include as a minimum in conformance to EN 50119/ relevant standards and the guidelines specified in ACTM :

(1) Visual Inspection: This shall include check for accuracy of construction for ensuring that all the structures, equipment, insulators, jumpers and conductors have been erected as provided in approved Drawings and they are not damaged and remain in healthy state.

(2) Dimensional Checks: This shall include dimensional checks to ensure the execution of permanent Works are within the limits of tolerance permitted so as to permit the current collection by locomotives to be satisfactory.

(3) Final Physical Check

This shall validate as a minimum that all temporary earths are removed, wires are present and in good condition, nothing is fouling with the OHE and all insulators are undamaged and present and auto-tensioning devices are installed and are functional. All sections of OHE / spans are provided with connectivity jumpers.

(4) Earthing And Bonding

All earthing and bonding arrangements have been completed.

(5) Section Proving

This test shall be undertaken in each electrical section, to ensure that each electrical section can be successfully isolated from adjacent electrical sections and that the correct OHE alive indications are shown in the TSS control rooms and the on the SCADA system.

(6) Clearance for Test Charging

The contractor shall ensure that all equipment, tools and M&P are removed from the site and the OHE / Equipment are free from any hindrance, physical obstruction, and is safe for personnel, before seeking clearance from the Engineer for test charging.

(7) Anti-Theft Charging of OHE

- (a) As an anti-theft measure, the OHE after erection shall be charged at 2.2kV by the Contractor. All arrangements for taking supply from the supply authority or otherwise shall be done by the contractor. However, before such anti-theft charging safety of Personnel of all the contractors and of Employees of adjacent Railway System has to be ensured. This includes:-
- (i) Permission of the Employer.
 - (ii) E.I.G. Sanction: Appointment and Placement of authorized personnel.
 - (iii) Issue of public notice in Local Newspapers for information to public.
 - (iv) Notice to adjacent Indian Railway Administration.
 - (v) Procedure providing for issue and cancellation or permit to work on or in vicinity (within two meters of the conductors & 25 KV equipment) to all concerned through and to authorized Personnel as a requirement before the lines can be charged as an anti-theft measure. The list of authorized Personnel shall be approved by the Engineer and provided to all the concerned authorities.
 - (vi) Control Room for 24X7 hour monitoring of the charged sections and its patrolling. Communication facility to enable monitoring of the OHE and management of Permit TO Work (P.T.W.).
 - (vii) Issue of certificate to authorized Personnel for charge & discharge of line.
 - (viii) Communication with patrol party and control room.
 - (ix) Attending to alarms.
- (b) The contractor will give notice to all the designated Contractors, who will take necessary precaution while carrying out the works keeping in view the anti-theft charging of OHE. This antitheft charging shall not be done until "no objection" is received from the Engineer and confirmation received from him that IR staff have been warned of the hazards of adjacent line of DFC being charged and have been trained on the precautions required to be taken by them.
- (c) Detailed rules shall be prepared by the Contractor and put up to the

Engineer for approval & issue to all concerned.

(8) Tests Prior to Commissioning of a section

(a) Short Circuit Testing

Each electrical section shall be subject to electrical short circuit test at the remote end under normal feeding and one short circuit using the extended feeding arrangements. This test shall confirm the mechanical integrity of the OHE and validate that the substation protection systems function correctly.

(b) Steady current tests.

The steady current test shall be undertaken in each block between TSS and the adjacent TSS. This test shall be used to validate the EMC safety case, validate protection system and to confirm the currents in earthing and bonding cables and to allow the measurement of accessible voltages at strategic point in each electrical section.

12.2.2 The Contractor shall not energize the TSS, SSP, ATS or the OHE until all interfacing parties have issued a letter of no objection. Once all third party letters of no objection have been received then the Contractor shall apply to the Engineer to seek a letter of no objection to proceed with Energization of the electrical section.

12.2.3 The Contractor shall be responsible for surveillance and security of the power supply systems including padlocking or otherwise maintaining control of the substation, padlocking of Switchgear and circuit breaker units, distribution switchboards, power panels, etc. throughout all Energization stages of the installation.

12.2.4 The Contractor shall interface with the other Contractors to ensure no downstream cables or other electrical equipment is energized before it has been tested and before other involved Contractors facilities are ready and secured.

12.3 RE-TESTING

12.3.1 When defects are detected in the equipment accessories, etc. during the commissioning tests, the Contractor shall ensure that adequate spares are kept on site to promptly attend to such defects.

12.3.2 In the event of the defect on any item being of such a nature that the requirements of these Specifications cannot be fulfilled by adjustment or modification, such item shall be replaced by the Contractor at his own expense, after carrying out the tests as per the relevant specifications for acceptance by the Engineer.

12.4 INSTALLATION TESTS

12.4.1 An inspection and visual verification of ratings and connections of equipment, instrument transformers and auxiliary circuits, installation tests shall be carried out.

12.4.2 After installation of equipment, visual inspection and operational tests on un-energized equipment shall be carried out to check the following:

- (1) Cleanliness;
- (2) Workmanship;
- (3) Confirmation of items conforming to ratings specified;

- (4) Water and dust proofing;
- (5) Leveling, mounting and positioning;
- (6) Joints and connections tightness;
- (7) Cables – dressing, bending radii, jointing and finish at terminals;
- (8) Clearances and dimensions in conformity with Drawings;
- (9) Earthing and bonding;
- (10) Functioning of circuit breakers, isolating switches and their interlocks;
- (11) Protection devices;
- (12) Phase sequence verification;
- (13) Conforms to as built records.

12.4.3 Earth resistance measurements shall be carried out individually for the subsystem and the system as required.

12.4.4 Insulation Resistance

The Insulation resistance of all 132kV and 25kV circuits shall be tested with an Insulation tester of 5 kV. All LV circuits comprising ac and dc auxiliary circuits shall be tested with a 500 V Insulation tester.

12.4.5 Continuity Test and Contact Resistance

Continuity of all circuits shall be verified. Contact resistance of all high current joints and bolted contacts, especially the joints of 25 kV conductors and the running rails for return current shall be measured with a Ductor set with a resolution of $1\mu\Omega$. Earth system joints shall also be measured.

12.4.6 Protection Equipment

(1) Tests on Current Transformers

- (a) Insulation resistance
- (b) Winding resistance
- (c) Polarity or Connections up to equipment terminals.
- (d) Ratio and magnetization curve verification

(2) Tests on Voltage Transformers

- (a) Voltage ratio
- (b) Insulation resistance
- (c) Polarity of connections up to the equipment terminals.

(3) Secondary and primary injection tests

Tests shall be carried out at a minimum of three settings if multiple settings are available. Test results of operation boundaries and operating times shall be recorded.

(4) Batteries and Chargers

- (a) Discharge tests and charging tests shall be carried out to verify the capacity of the batteries and all functions available on the charger.

- (b) Continuous measurements of battery voltages shall be made together with periodic readings of the electrolyte specific gravities and temperatures.
- (c) No addition of electrolyte is permitted during discharge tests.
- (d) The operation of the boost charge facility and the effect of the voltage dropping diodes shall also be demonstrated.

(5) Control, Indication and Alarm Functions

- (a) Insulation resistance and continuity of all cores of cables shall be identified and tested.
- (b) The correct functioning of all control, indication and alarm devices shall be verified.

(6) Switchgear

- (a) All switchgear, including circuit breakers, isolating and earthing switches, shall be operated to prove that the operating gear, tripping devices, protective gear and mechanical interlocking are satisfactory.
- (b) SF6 gas leakage test shall be performed where applicable.
- (c) Closing time for all circuit breakers shall be verified.

(7) Instruments and Transducers

All current and voltage transformers, metering instruments and transducers shall be calibrated by voltage and current injection to prove their accuracy classes.

(8) Power Transformers

- (a) Voltage ratio at all taps, functioning of tap changers and Insulation measurements shall be performed.
- (b) Oil circulation and oil testing shall be performed.
- (c) Simulation tests shall be carried out to determine correct operation of all protective relays.
- (d) Test shall be undertaken in accordance with those set out in the Transformer specifications in chapter 19 Annexure – 9.

12.5 PARTIAL ACCEPTANCE TESTS

12.5.1 These tests form part of on-site and System Acceptance Tests as part testing of the equipment and system.

- (1) Functional Tests and Interlock Tests
- (2) All control and protection functions and electrical/mechanical interlocks shall be tested.
- (3) Primary Injection Tests
The Contractor shall carry out primary injection tests on each protective system, to prove the auxiliary circuit connections, the relay fault setting values, the correct metering indications and the stability limits.
- (4) AC/DC Pressure Tests
 - (a) The Insulation resistance of all circuits shall be measured before and after

the dc pressure test. The minimum phase-to-phase and phase-to-earth Insulation resistance shall be as per relevant standards.

- (b) Pressure tests shall be carried out on completed cable lengths of high voltage cables in accordance with IEC 60502.

12.6 SYSTEM ACCEPTANCE TESTS

12.6.1 Energization

- (1) The Contractor shall prepare operation safety rules and procedures for the review of the Engineer before Energization.
- (2) The Contractor shall carry out all necessary checks to ensure safe Energization.
- (3) The Contractor shall be responsible for the operation of traction and auxiliary power equipment. Upon request by the Engineer, the Contractor shall be responsible for the disconnection and the subsequent reconnections of the power equipment or of overhead equipment or connections of traction lines.

12.6.2 Tests

System Acceptance Tests shall include but not be limited to:-

- (1) Functional tests of SCADA system
- (2) Integrated Tests with Engineers Train Operator
- (3) Short Circuit Tests on OHE

Short Circuit Tests on 25kV overhead lines shall be carried out to prove correct operation of protection equipment and to ensure that the dynamic strength requirements of overhead equipment are met. Short Circuit Tests shall be carried out on every overhead equipment line feeder.

(4) Current Collection Test

The contractor shall conduct current collection tests as per EN 50317 to demonstrate that newly installed OHE satisfies the quality requirement for maximum test speed. The behavior of the OHE shall be watched at various speeds. Current collection shall be considered unsatisfactory, if any blue flash/spark is observed, indicating that the contact between the pantograph and contact wire is not smooth. In such cases remedial action shall be taken to rectify and restore smoothness in the contact wire.

(5) Dynamic Validation

- (a) Dynamic validation shall be undertaken to ensure compliance with the specified current collection criteria of all relevant parts of the work including track work, rolling stock and catenary interfaces.
- (b) The criteria for measurement shall be loss of contact with measurable arcs lasting longer than 10ms (maximum 25ms) shall not occur more than once in 100m.
- (c) The Contractor shall agree with the Engineer the selection of a suitable method and equipment, which determines compliance with the current collection standard within the range of operating conditions.
- (d) The system dynamic performance shall comply with the requirements of EN

50119.

(6) Earth Fault Test on OHE

Earth fault tests shall be conducted on OHE traction wires and feeder wires to prove correct operation of protective equipment as described in ACTM.

12.7 INTEGRATED TESTING AND COMMISSIONING

12.7.1 Integrated Testing and Commissioning refers to those tests undertaken in order to demonstrate that the various components of the railway systems operate satisfactorily between one another and meet all specified requirements for design, operability, safety, and integration with other works and systems.

12.7.2 These tests shall be entirely within the requirements of one or more of the Project Contracts or they shall involve a multiplicity of Contract procedure. The final Integrated Testing and Commissioning shall be carried out after the SCADA system and OCC have become operational.

12.7.3 Those systems that can be tested without depending on the running of trains, such as SCADA system, etc. will have their integration tests scheduled to commence as early as possible. It is preferable that any interface problems associated with these "train less" system tests be identified and resolved prior to the commencement of test running.

12.7.4 The following is an indicative listing of those Integrated Testing and Commissioning functions that are necessarily to be integrated with others to demonstrate that the equipment and controls installed therein meet the Contract Specifications and demonstrate a safe-to-operate condition. This list is not exhaustive and the same shall be updated by the contractor, to demonstrate functionality, completeness and safety of the installed works. The updated list shall be approved by the Engineer

- (1) Load sharing test between traction transformers during train acceleration.
- (2) Load measuring test for circuit breakers.
- (3) Harmonic measurement.
- (4) TSS, SSP and ATS failure mode test.
- (5) Remote control and monitoring test through SCADA system at OCC.
- (6) Power system functional tests.
- (7) EMI/EMC tests.
- (8) Touch/step potential tests.

12.7.5 On-load Tests and Directional Tests

Once sufficient load current is established, voltages and currents into protection and metering equipment shall be verified to ensure correct operation of protection relays and accuracy of meter readings at local and remote locations.

12.8 SERVICE TRIALS

The Contractor shall provide special and general attendance during the Service Trials period such that the persons who carried out the On-Site Testing and Commissioning are available on Site to solve any problem arising from the Service Trials.

12.9 PERFORMANCE VERIFICATION

- 12.9.1 The Contractor shall carry out all Performance Tests to verify that the performance of the System meets the Employer's Requirements after substantial completion of the Works.
- 12.9.2 The Performance Tests shall be carried out by the Contractor in conjunction with relevant parties (e.g. Indian Railways).
- 12.9.3 The measurement of EMI levels shall be carried out prior to Energization of the Traction Power System, and then during Service Trials and commercial operation of the train services to ensure that the EMI levels comply with the requirements of these Specifications.
- 12.9.4 Should the performance of the System deviate from the Particular Specifications, the Contractor shall make every effort to rectify the deviation in the shortest possible time, and to the satisfaction of the Engineer.

12.10 TRACTION INSTALLATION HANDING OVER / TAKE OVER

- 12.10.1 The conditions for Handover / Takeover of the Traction installation are as follows:
- (1) The Contractor shall hand over the DFC Railway sections of the traction installation to the Engineer on the Co-ordination Dates as per Conditions of the Contract. From this date, any access to the DFC Railway Installation by the Contractor shall be in accordance with any procedures, requirements and conditions laid down by the Engineer.
 - (2) At the time of Takeover, the Contractor shall have executed all the works of Employer's requirement as described in GS and PS including structures, all safety works, screens, barriers from High Voltage and affixed all Safety and Warning Signboards and all other works provided by the Contractor within the Railway Envelope, the installation of all equipment and fixings defined under relevant chapter(s) and shall ensure that the Envelope is complete, secure, safe for the operation of trains, and has the Engineer's approval for effective Takeover.
- 12.10.2 The conditions for access to the DFC Railway Envelope after handover are as follows:
- (1) Access to the DFC Railway Envelope after takeover will be controlled by the Engineer. Access will be given to the Contractor and to other contractors by the Engineer for inspecting, maintaining, adjusting and repairing, by prior arrangement and for limited periods. The work on High Voltage sections will be subject to 'Permit to Work' procedure.
 - (2) At the time of Handing over, the Contractor shall nominate a responsible In-charge and a person contactable on twenty-four (24) hour basis to liaise with the Engineer during Defect Notification Period. The Contractor shall give two weeks' notice of his desired track and /or High Voltage equipment possessions, and, when requested, at the appropriate meetings, track possession and or Traction Installation possession allocations will be made by the Engineer. It may be necessary for the Contractor's work to be carried out intermittently or at night if suitable possessions cannot be given during its preferred hours. During all such operations the Contractor will be fully responsible for safety of men, equipment and Works.
 - (3) Prior to the issue of Taking Over Certificate, the Engineer will ensure the

completion of following activities:

- (i) Testing of traction equipment and other equipment and facilities required for operation of the railway. During this period the Engineer and/or his contractors will be running work trains through the Railway Envelope;
- (ii) Acceptance tests, Integrated System Tests and test running;
- (iii) Trial running: during this period the Engineer will be operating trains and equipment on a trial basis, the frequency of which will increase as the trials proceed until full operating frequencies & performances are achieved.

12.10.3 The Contractor shall take into account of the Engineer's activities and train operations in planning and programming its Works.

- (1) The conditions for access to the DFC Railway Envelope on the Work Site after issue of Taking over Certificate on completion will be administered by the Engineer.
- (2) Prior to the substantial completion of the Works, the Contractor will be given extended possessions of the Railway Envelope for the purposes of final adjustment, tightening, touching up or cleaning up prior to the final inspection of the Works. Such possessions shall be agreed with the Engineer.
- (3) Safe Earthing and Bonding of the Traction Installation, screens and access barriers against exposure of 25 kV ac, supply to public and unauthorized personnel etc. as required in terms of safety provisions of relevant standards and safety regulations shall be supplied and installed by the Contractor before the Takeover of the Traction Installation by the Engineer.

(End of Chapter 12)

CHAPTER 13 - SPARES, SPECIAL TOOLS, TESTING & DIAGNOSTIC EQUIPMENT AND MEASURING INSTRUMENTS

13.1 GENERAL

- (1) The Contractor shall supply spare parts, special tools and test equipment in accordance with Employer's Requirements, Part 2, Section VI, Vol-1, Chapter 14 – Operation & Maintenance, Spares, Tools & Plants , of General Specifications and as per specifications / provisions mentioned in Table 13.2.1 & 13.3.1 as under.
- (2) In addition, the Contractor shall submit to the Engineer a Schedule of Recommended Spares including consumable, duly indicating for each item, description, part number, drawing number, lead time, shelf life and number of units having due regard to the lead time of respective Spares.
 - (a) The Contractor shall base the spares calculations on the reliability and availability data and the criticality of the equipment and submit these calculations to the Engineer for review.
 - (b) The Schedule of Recommended Spares shall:
 - i. be grouped by plant & equipment, manufactured items and system/sub-system, test equipment and special tools as applicable for stocking identification;
 - ii. Have detailed description with drawing references and correlation with the maintenance manuals.
- (3) The Contractor shall submit the name(s) & address(s) of primary and secondary source(s) of all the spares, who shall supply the spares and consumables.
- (4) In the event that any of the spares identified have a particular shelf life or special storage requirement, this shall be made known to the Engineer with the submission including the necessary action for disposal or storage.
- (5) All spares shall conform to Identification and Configuration Control requirements established by the Contractor for the equipment provided under the Contract.
- (6) Testing of the Spares - The Contractor shall ensure that all spares are correctly calibrated, tested and labeled prior to their delivery. Test/Calibration Certificates for each one of the spares shall be submitted to the Engineer.
- (7) All kinds of consumable not limited to printer cartridges, tapes and papers etc. shall be supplied by the Contractor for the period up to the handing over of the Work to the Employer.

13.2 CONTRACT SPARES

The Contractor shall supply Spares as given below.

Table 13.2.1: Quantity of Contract Spares

S. No	Item Description	Quantity
A. OHE Spares		
1	All types of structures including portal parts	2 % of each type used for the project, subject to min of 5 nos. and maximum of 20 nos.
2	catenary and contact Conductors, Fittings, hardware and all types of Jumpers& droppers	2% of Installed quantity,
3	Set of Cantilever Brackets with insulators	10 nos.
4	9-T insulators	10 nos.
5	Feeder Conductor	1 kms
6	Aerial Earth Wire and BEC as required	1 km each
7	OHE Section Insulators	4 sets
8	OHE Auto-tensioning device sets	4 sets
9	Counter weights for ATD	4 sets
10	Stainless steel wire rope for ATD	6 sets
11	PTFE type Neutral Section	2 sets
12	Splices for conductors, feeders	3 nos. for feeder wire 10 nos. for Contact wire 10 Nos. for Catenary Wire And Minimum of 5 nos. of splices of each type of other conductors used such as Large Span wire etc, AEW, BEC as required.
13	Spares for OHE other than above (1 to 12)	Apply 2% subject to quantity in whole nos. next higher no/ weight for hardware items
B : PSI (TSS,SSP) - Spares		
1	LA for 132 kV (or as per incomer supply)	2 nos. LAs for 132kV
2	LA 42 kV	2
3	25kV PT	2
4	25kV CT	2 each type
5	Double pole Interrupter 54/2x25kV	2
6	Double pole Isolator motor operated 54/2x25kV	2
7	Double pole CB 54/2x25kV	2
8	132kV CB	1 nos. 132kV
9	132 kV CT	1 nos. 132kV
10	Isolator 132 kV	1 nos. 132kV
11	String insulators 132 kV	1 sets of each Type of 132 kV as per the TSS supply voltage
12	Post Insulators 132 kV	5 nos. 132 kV
13	Post Insulators 25 kV	10

14	Auto Transformer	1 Nos - (1 No suitable for TSS and 1 no for SSP based on short circuit capacity)
15	Auxiliary Transformer 25 KVA	1 nos.
16	Auxiliary Transformer 10 KVA	2 nos.
17	Auxiliary Transformer 100 KVA	nil
18	Circuit Breakers, CTs, PTs and other accessories as used for the project	Minimum 5% subject to Minimum of 1 nos.
19	PSI (TSSSSP) - Spares other than item 1 to 18 above (connectors, jumpers, hardware, bus bars etc.)	5 % subject to min of 1 nos./ meter/kg and max of 10 nos./ meter /kg
20	Spares of Autotransformer	As per list of spares included in the specification given in relevant Chapter for required rating.
21	Spares of traction transformer	As per list of spares included in the specification given in relevant Chapter for required rating.
C. Protection and Metering		
1	Control and auxiliary relays	1 set of each type
2	Protection relay	1 set of each type
3	Metering Relay	1 set of each type
4	Transducers	1 set of each type
D. SCADA System		
1	Spare Cards for RCC/OCC	Minimum 10% spare cards but not less than five of each type
2	Spare Cards of Each type	10% spare cards but not less than five of each type at the time of Handing over

13.3 SPECIAL TOOLS, TESTING AND DIAGNOSTIC EQUIPMENT AND MEASURING INSTRUMENTS

- (1) The Contractor shall supply the following items given below in Table 13.3.1.
- (2) The contractor shall submit a schedule of recommended Tools and Test Equipment with details of calibration and supplier(s).

Table 13.3.1: List of Special Tools and Instrument

S. No	Description	Quantity in No's
1	Cable Fault Locator	2 sets
2	AC Power Line Analyzer	4 nos.
3	Digital earth testers	3 nos.

S. No	Description	Quantity in No's
4	Earth Leakage Detector 1000 V	3 nos.
5	Digital Insulation Tester 2.5/ 5 kV	3 nos.
6	Digital Insulation Tester 0 – 1000 V	3 nos.
7	Primary injection test kit	2 nos.
8	Secondary injection test kit	2 nos.
9	Relay Testing Kits	2 nos.
10	Infra-red remote temperature sensor	3 nos.
11	Fully automatic Oil dielectric test kit with printer	2 nos.
12	i) Thermal Imaging Camera capable of being mounted on Tower Wagon /loco ii) Hand held Thermal Imaging camera	3 nos. 3 nos.
13	Video Camera	2 nos.
14	Height and Stagger gauge (instrument laser based)	4 sets
15	Dissolved Gas Analyzer set	2 nos.
16	Hydraulic Compressor for Aluminum conductor Splicing Zig (all sizes)	2 sets
17	Turfers all weight categories	5 each type
18	Pull lift all weight category	5 each type
19	Come-along clamps for different conductors	10 for each size
20	Discharge Rod complete including earthing cable and connectors	20 nos.
21	Aluminum Ladders (5 m and 11 m extendable)	5 each
22	Portable petrol/ kerosene set 1.5 KVA	3 nos.
23	Vehicle mounted Oil filtration plant 1 phase 3000 liters per hour capacity	2 nos.
24	Portable diesel Generating set 3 kVA 230 V.A.C.	4 nos.
25	150 sq.mm Contact wire Cutter 36"	5 nos.
26	Wire Cutter 12"	5 nos.
27	"D" Shackle set (1", 3/4", 5/8", & 1" One Each)	5 nos.
28	Single sleeve Pulley Block 3.5" x 5/8" Groove Fiber for drawl of contact. & catenary wire	5 nos.
29	Portable rail drill machine.	3 nos.
30	Siren 3 phase Range 5 Km and 1 phase Range 1 Km	2 each
31	Ladder Trolley capable of running on track	3 nos.
32	DE and Ring Spanner sets suitable for Fittings being supplied	5 nos.
33	Chain pulley block all weight category as required for erection	5 nos.
34	Hydraulic insulator testing jig	7 nos.
35	Copper Hammer	4 nos.
36	Nonmetallic Hammer	3 nos.
37	Micro Meter	5 nos.
38	Fiber measuring Tape 30 mtr. & 15 mtr. Each	5 nos.
39	Isolator pad lock	5 nos.
40	Neutral Section inspection Jig	7 nos.

S. No	Description	Quantity in No's
41	Nylon rope 20 meters length	5 nos.
42	Diagnostic kit(LAPTOP) along with software capable of testing all type of modules to identify faults	7 nos.
43	Digital Multi-meter	3
44	Portable operated tree pruner	14
45	Motorised Earth Augur	3
46	Crimping Tools for droppers/ conductors (all types)	5
47	Operating rod for DO fuse (Pull Rod)	6
48	Inflatable lighting tower	3
49	Portable Power hacksaw	2
50	Safety Helmet	25
51	Safety Harness	10
52	Hand blower	4
53	Vacuum Cleaner	2
54	Vehicle mounted Oil filtration plant 1 phase 300 liters per hour capacity	2
55	Box spanner set	4
56	Portable Tan Delta & Capacitance Measuring Bridge	2
57	Capacitance meter	2
58	Portable grinder Electrically operated	2
59	Steel sling with eye each end 1 m, 2 m and 3 m	5 each
60	Steel sling with eye each end 5 m, 10 m	4 each
61	Twister cum bender 6"	5
62	Motor Trolley	2

13.4 TECHNICAL SPECIFICATIONS FOR SPECIAL TOOLS, TESTING AND DIAGNOSTIC EQUIPMENT AND MEASURING INSTRUMENTS

The specifications of few special tools and diagnostic equipment are summarized hereunder. This list of specification is not exhaustive and may not cover all the tools, equipment and instruments. The contractor shall submit a schedule of recommended Tools and Test Equipment along with technical specifications in detail for the approval of the Engineer.

- 13.4.1 **Cable Fault Locator** - Voltages up to 0 ... 12 kV, display of end and fault distance, display at least 5" size, DC Hipot Function, ARM Method, Direct Thump Method, TDR Function, Sheath Test, Sheath Fault, Integrated Battery, Truly portable, rain proof and low weight, TDR options in both operational modes, QUICK-STEPS and EXPERT Mode shall be individually programmable by customer. Fault location by the magnetic field and sound signal coincidence method, Excellent acoustic characteristics (frequency range 100 Hz to 1.5 kHz).
- 13.4.2 **Earth Leakage Detector** - Range: 0-30 mA/300 mA/30 A/300 A, 0.01 mA resolution for measuring earth leakage currents, Jaw Opening 40 mm, Analogue Bar graph Display for

trending, 300 V phase to earth and 500 V phase to phase CAT III or 600 V CAT II double insulated, , Safety - IEC1010-1, EMC-IEC61326-1.

- 13.4.3 **Earth Megger** - 20 kilo ohms with 1 mohm Resolution with accuracy ± 0.5 %, Test Frequency: 105 - 160 Hz in 0.5 Hz Steps, Test Current : 50 mA, Maximum Output Voltage: < 50 Vrms, Maximum Interference: 40 Volts Peak to Peak (50 Hz), Measurement Standards: BS: 7430 (1991) and VDE 0413, Part 7, IP54, Safety - IEC1010-1, EMC-IEC61326-1.
- 13.4.4 **Digital Megger 10000 V** - Mains (without battery) operation & rechargeable battery operation, 35TOhms, Short circuit current 6 mA, noise rejection 8 mA, Guard out parallel leakage resistance with a max error of 2%, IP65 rated & CAT IV rating, Safety - IEC1010-1, EMC-IEC61326-1.
- 13.4.5 **Primary injection test kit** - 2000Amps @3 minutes, Open circuit voltage 6V, fine adjustment knob (Variac) on control panel with inbuilt display, positive and negative buttons for coarse adjustment of current, Design of test set should be based on transformer technology and not on spire (hole) through technology for better efficiency.
- 13.4.6 **Secondary Injection Test Kit** - Output AC Current 250A, AC Voltage 250V, DC Voltage 0-300V, 0-359deg, 15-550Hz, Plotting excitation curves, Current and voltage transformer ratio tests, Burden measurement for protective relay test equipment, Impedance measurement, Efficiency tests, Polarity (direction) tests, CE-marking, Weight should not exceed 19Kg.
- 13.4.7 **Relay Testing Kits** - Modular in Design, 6 current source - 3 X60A + 3X15A, 4 voltage sources out of which 3 are convertible to current sources - 3x300V, Max Compliance voltage L-N 50V and L-L 100V, Power Consumed 1800VAmx, Manual Control LCD Touch Screen, IEC 61850 Testing Capability, Safety - IEC1010-1, EMC-IEC61326-1.
- 13.4.8 **Oil dielectric test kit** - BDV 100KV with inbuilt oil temp measurement, HV switch off time shall be <10us , external calibrator, Safety - IEC1010-1, EMC-IEC61326-1 Class B.
- 13.4.9 **Tan Delta Kit** - Voltage 25V-12kVAC, inbuilt voltage dependency detection, automatic PF Tip up test, generate its own temperature correction factor by using variable frequency method from 1hz to 500hz, Safety - IEC/EN 61010-1:2001, EMC - EN 61326:1997/A1:1998/A2:2001/A3:2003.
- 13.4.10 **Measurement of Moisture in Paper by Frequency Domain Spectroscopy** - Output Voltage 200V, Output current 50mA, Frequency range 0.1mHz - 10kHz, Excitation current Measurement, Tan Delta measurement @50 Deg, Oil conductivity, Measurement time upto 1mHz would be around 22minutes, Measurement time upto 2mHz would be around 12 minutes, Safety - IEC/EN 61010-1:2001, EMC - EN 61326:1997/A1:1998/A2:2001/A3:2003.
- 13.4.11 **Sweep Frequency Response Analyser** - Frequency range 0.1 Hz – 25 MHz, No. of points Up to 32 000 points, user selectable, inbuilt Battery, 0.20 – 20 V peak to peak compliance voltages, Fulfills requirements in IEC 60076-18, IEEE C57.149-2012, CIGRE Technical Brochure 342, DL/T 911-2004, external calibrator, Safety - IEC1010-1, EMC-IEC61326.

- 13.4.12 **CT Analyser Kit** - Multi tap (suitable for up to 5 taps) analyzer, Ratio measurement, polarity, CT secondary resistance measurement, Excitation characteristics plot, CT burden testing, IR testing, Single Phase relay testing, standard testing procedure like IEC60044-1,6, IEC61869-1, IEC61869-6 ANSI45,30, Safety - IEC1010-1, EMC-IEC61326.
- 13.4.13 **Transformer and Sub-station test system** - Automated 3Phase/6winding measurement for Turns Ratio, Winding Resistance (100A/50V), Demagnetization, Load tap-changer continuity, timing and dynamic resistance measurement, Excitation Current, Leakage Reactance, FRSL and Magnetic Balance Measurement, Single Phase testing of primary and secondary relays, AC Insulation testing with frequency range of 1 - 505 Hz with Intelligent Temperature Correction. Primary Injection Test up to 800A, Contact Resistance Measurement up to (100A/50V), Display of the unit must be 10.4" TFT touch type with 1024x768 resolution. CE- marking.

(End of Chapter 13)

CHAPTER 14 - RELIABILITY, AVAILABILITY, MAINTAINABILITY, AND SAFETY

14.1 GENERAL

The Project is to be designed with high degree of reliability and availability as per Employer's Requirements, Part 2, Section VI, Vol-1, and Chapter-12 on- Reliability, Availability, and Maintainability & Safety of General Specifications and as per specifications / provisions mentioned below:

14.1.1 The Contractor shall demonstrate that the traction power supply and OHE system shall meet all the RAMS requirements specified for this system. These specifications define a set of RAMS requirements for the Electric Traction System to be used, assessment and controls of threats to RAMS, Plan & Implement RAMS Tasks, demonstrate achievement of adequate Reliability, Availability, Maintainability & Safety (RAMS) Assurance. This includes the setting up a monitoring system to monitor during life cycle of compliance, Safety and RAM targets to be achieved and establishment of a Reliability, Availability, Maintainability and Safety (RAMS) assurance process to ensure that hazards are identified and managed and that the Safety and RAM targets can be shown to be met.

14.1.2 The design performance of traction system shall provide very high level of Reliability, Availability, Maintainability and Safety through RAMs analysis, which can be demonstrated through data gathered during previous operation of the 2 X 25 kV Traction System.

14.1.3 Terms & Definitions and Abbreviations

(1) In this document, following defined terms shall have the meanings as described here below:

Definitions	Descriptions
Apportionment	process whereby the RAMS elements for a system are sub-divided between the various items which comprise the system to provide individual targets
Assessment	undertaking of an investigation in order to arrive at a judgment, based on evidence, of the suitability of a product
Availability	ability of a product to be in a state to perform a required function under given conditions at a given instant of time or over a given time interval assuming that the required external resources are provided
Compliance	A demonstration that a characteristic or property of a product satisfies the stated requirements.
Corrective Maintenance	maintenance carried out after fault recognition and intended to put a product into a state in which it can perform a required function
Down time	time interval during which a product is in a down state
Failure mode	predicted or observed results of a failure cause on a stated item in relation to the operating conditions at the time of the failure

Definitions	Descriptions
Fault tree analysis	analysis to determine which fault modes of the product, sub-products or external events, or combinations thereof, may result in a stated fault mode of the product, presented in the form of a fault tree
Hazard	physical situation with a potential for human injury and/or damage to environment
Hazard log	Document in which all safety management activities, hazards identified, decisions made and solutions adopted are recorded or referenced. Also known as a "Safety Log"
Maintainability	probability that a given active maintenance action, for an item under given conditions of use can be carried out within a stated time interval when the maintenance is performed under stated conditions and using stated procedures and resources
Preventive maintenance	maintenance carried out at predetermined intervals or according to prescribed criteria and intended to reduce the probability of failure or the degradation of the functioning of an item
Reliability	probability that an item can perform a required function under given conditions for a given time interval
Reliability growth	condition characterized by a progressive improvement of a reliability performance measure of an item with time
Repair	that part of a corrective maintenance in which manual actions are performed on the item
Restoration	that event when the item regains the ability to perform a required function after a fault
Risk	probable rate of occurrence of a hazard causing harm and the degree of severity of the harm
Safety	freedom from unacceptable risk of harm
Safety case	documented demonstration that the product complies with the specified safety requirements
Safety integrity	likelihood of a system satisfactorily performing the required safety functions under all the stated conditions within a stated period of time
Safety integrity level (SIL)	One of a number of defined discrete levels for specifying the safety integrity requirements of the safety functions to be allocated to the safety related systems. Safety Integrity Level with the highest figure has the highest level of safety integrity
Safety-critical	Failure of the system, sub-system or equipment will directly lead to a situation with the potential to cause harm, injury, damage to property, plant or equipment, damage to the environment, or economic loss.

Definitions	Descriptions
Tolerable risk	maximum level of risk of a product that is acceptable to the Railway Authority
Validation	confirmation by examination and provision of objective evidence that the particular requirements for a specific intended use have been fulfilled
Verification	Confirmation by examination and provision of objective evidence that the specified requirements have been fulfilled.

(2) Abbreviations

Abbreviation	Definition
ALARP	As Low as Reasonably Practicable
DT	Down Time
EN	European Norm
FMECA	Fault Mode Effects and Criticality Analysis
FMEA	Fault Mode and Effects Analysis
FTA	Fault Tree Analysis
FRACAS	Fault Report Analysis and Corrective Action System
GS	General Specifications
IHA	Interface Hazard Analysis
ISO	International Organization for Standardization
IEC	International Electro-technical Commission
MCIL	Maintainability Critical Item List
MDT	Mean Down Time
MTBF	Mean Time Between Failures
MTBSAF	Mean Time Between Service Affecting Failure
MTTR	Mean Time to Restore
O&SHA	Operating and Support Hazard Analysis
OPM	Other Preventive Measures
PHA	Preliminary Hazard Analysis
PS	Particular Specifications
RAM	Reliability Availability Maintainability
RAMS	Reliability Availability Maintainability and Safety
RBD	Reliability Block Diagram
RCIL	Reliability Critical Item List
RDT	Reliability Demonstration Testing
RTU	Remote Terminal Unit
SCIL	Safety Critical Items List
SSHA	Subsystem Hazard Analysis

14.1.4 RAMS Principles

- (1) The 2x25kV, ac, Electric Traction system shall be designed to achieve all RAM requirements specified in this PS and EN 50119.

- (2) The design, manufacture, installation and commissioning of the equipment as well as training of the operating and maintenance staff shall be such that to ensure near Zero Failure performance in the initial stages and that the few defects & deficiencies that may be exposed during the Service Trial are totally eliminated.
- (3) All the sub-systems and equipment to be used shall be of proven design with a high degree of reliability and in use in other similar Railway projects. Calculations shall be performed using appropriate design models involving relevant variables. The design values and verification methods shall conform EN:50119.
- (4) The sub-systems and equipment shall be engineered to maximize system availability during traffic hours, to minimize the amount of maintenance required and to ensure that any maintenance can be easily and quickly carried out in minimum time, with minimum skill, and at minimum cost.
- (5) Fault Tolerance & Graceful Degradation: The system shall be designed such that service can be maintained in the presence of Single point faults Scenario. Subsystems and components whose failure can significantly impact on RAM performance shall be backed up by built in redundancy in Sub-systems or components that permit continuous operation.
- (6) Recovery: Provision shall be made to recover from any credible fault while minimizing disruption to service.
- (7) Condition Monitoring & Diagnostics: Diagnostic systems shall be used to detect, or where practicable, monitor the condition of the equipment, anticipate faults, and do need based proactive Predictive maintenance and to reduce requirements for periodic inspection Preventive maintenance, to reduce overall costs, and improve reliability.
- (8) The Contractor shall submit system Reliability, Availability and Maintainability (RAM) Plan for review & approval of the Engineer/ Employer's Personnel for complete Electric Traction System comprises of Traction Power Supply (TPS), Overhead Contact System (OCS/OHE), and Power SCADA.

14.2 RELIABILITY

Reliability Modelling

- (1) The Contractor shall perform Reliability and Maintainability analyses of each system, up to the point of interface with other systems.
- (2) The Contractor shall develop an evolving Reliability model consisting of Reliability Block Diagrams and probability of success equations. This model shall show the relationships required for system and equipment to operate successfully. The reliability block diagrams shall include all elements essential to the successful performance of the system and the interrelationships and interface of these elements. The model shall not reflect the degraded mode of operation. The Contractor shall revise the model to keep current with design iterations.
- (3) The reliability model consisting of reliability block diagrams and probability of success equations shall be developed and submitted to the Employer for acceptance.
- (4) Reliability apportionment and prediction analysis shall be in accordance with established techniques or standards, or properly documented and verifiable field

failure data for identical or similar equipment. The standards used or the source of field data shall be identified.

- (5) The Reliability apportionment and prediction analysis shall be carried out in parallel with the design of the system. The relevant apportionment and prediction figures shall be part of the design submission documents for the individual equipment, sub-system and system.

Failure Definitions

- (1) Failure: The inability to perform a required function, the occurrence of unexpected action by the equipment, or the degradation of performance to below the required specifications shall constitute a failure.
- (2) Relevant Failure: A relevant failure of an item is an independent failure which results in a loss of function of that item caused by any of the following:
 - A fault in an equipment or sub-system while operating within its design and environmental specification limits;
 - Improper operation, maintenance, or testing of the item as a result of the Contractor supplied documentation.
 - Failures of transient nature including those with post investigation status as 'No fault found', shall be considered as relevant failure if in the opinion of the Employer these are attributable to Electric Traction System.
- (3) Non-relevant Failure: Any failure of an item not included in the definition of relevant failure, such as the following:
 - A failure caused by malfunction of other equipment or sub-system that are not supplied by the Contractor;
 - A failure caused by human error, except as noted in Relevant Failure above;
 - A failure caused by accidents not associated with the normal operation of the item;
 - A failure caused by operating the equipment or sub-system outside of design or environmental specification limits;
- (4) Service Failure: Any relevant failure or combination of relevant failures during revenue service operations to determine availability for revenue service, which results in one of the following:
 - Delay to train service;
 - Fault preventing a train from entering service at its scheduled time;
- (5) Pattern Failure: The repeated occurrences of 3 or more relevant failures of the same replaceable part, item or equipment in same manner in identical or equivalent applications when they occur at a rate which is inconsistent with the predicted failure rate of the part, item or equipment will be termed as pattern failure.

Reliability Requirements

- (1) Reliability requirements and goals shall be developed in terms of Mean Time Between Service Failures (MTBSAF).
- (2) The reliability requirement is subsidiary to the Availability and Maintainability

requirements as specified in this PS.

- (3) The Electric Traction System shall be fault tolerant such that the loss of functionality under failure conditions is minimized and that the system, where practicable, degrades gracefully and either continues to perform its required duty unaffected by failed elements.
- (4) Redundant equipment/module/component shall change seamlessly when active part fails. If changeover has a finite time, contractor shall show that its system shall not obstruct the train operation.
- (5) The system design shall ensure that the subsystems providing redundancy for failures are truly independent to minimize the risk of common mode faults.
- (6) The Traction Power Supply (TPS) shall be designed such that any single key components may fail without impact on the operational performance of the overall Electric Traction system. This shall be demonstrated by calculation of the load flow in case of outage of critical main components, e.g. main traction transformer.
- (7) All consumable and/or bought-out items shall have a high level of reliability, in particular where they shall remain continuously energized and in service e.g. insulators.
- (8) The Electric Traction system shall be able to be operated independently from Power SCADA. In event that the SCADA system fails then the traction power and its protection system shall continue to operate autonomously, until either the SCADA system comes on line or until the switching station is placed into local control.
- (9) The Contractor shall select the Equipment & components to achieve the required level of Reliability, Availability and Maintainability with highest MTBSAF matching with Industry benchmarks if any for approval of the Engineer.

Reliability Demonstration

- (1) During the RAM demonstration phase, the Contractor shall collect and maintain data on every failure along with the data indicating the probable failure. MTBF shall be calculated throughout the monitoring period. The Contractor shall submit monthly Reliability Demonstration Reports.
- (2) In case the Contractor is not able to achieve specified/predicted reliability target, the Contractor shall take necessary corrective measures either by way of change of design and/or replacement of the relevant equipment / component, at no additional cost to the Employer.
- (3) The Contractor shall analyze each and every failure/ defect of components of various equipment to determine the cause of failure and propose corrective measures, which would be reviewed by the Employer.
- (4) The high voltage circuit breakers, supply transformers, traction transformers, auxiliary transformers, interrupters, and AC cable (1000 Meters) have to be demonstrated for reliability as planned.

Reliability assessment

A Risk & failure study shall be performed for the various Sub-Systems, identifying the failure modes for each which contributes to reliability of the system and quantitative estimates prepared of the likelihood of failure. The system and the components shall

comply with EN 50126/IEC 62278.

- (1) The Contractor shall demonstrate the reliability of the proposed design and material for OHE equipment within the DFCC operating environment of Dadri – Khurja section.
- (2) For all critical items of the equipment offered the Contractor shall state the **Mean Time between Failure (MTBF)**, the Mean Time to Restore (MTTR), and details of preventative maintenance required to maintain full operational performance.
- (3) Where equipment has novel features or where insufficient operational data is available, the Contractor shall state the methods used to determine reliability performance.
- (4) All consumable and/or bought-out items shall have a high level of reliability in particular where they shall remain continuously energized and in service e.g. insulators.
- (5) Reliability criteria of Traction Power Supply System shall be as per class in table below

Reliability Class	Description (Service affecting Failure)	Reliability Class Criteria (Failures per annum)
R1	Delay to train services exceeding 12 minutes, or fault preventing a train from entering service at its scheduled time.	35
R2	Delay to train services exceeding 30 minutes	10
R3	Delay to train services exceeding 60 minutes or closure of a crossing or a junction station for more than 2 hours, or implementation of single line working for a period of one hour or more.	0.667
R4	Severe service disruption resulting in trains being stranded on track for more than two hours or closure of a crossing or a junction station for more than one day	0.333
TOTAL		46

14.3 AVAILABILITY

- (1) The Contractor shall be responsible for providing a System design, maintenance procedures, and defining the recommended spares holdings to ensure that the Availability requirements of the system shall be achieved.
- (2) Availability shall be assessed by the calculated as follows:

$$Availability(A) = \frac{MTBSAF}{(MTBSAF + MTTR)}$$

Where: $0 \leq A \leq 1$

- (i) MTBSAF = Mean Time Between Service Affecting Failures.
- (ii) MTTR = Mean Time to Restore

- (3) The Contractor shall submit calculations with reliability block diagrams for each sub-system till LRU level to demonstrate the compliance with specified availability figures. The availability calculation shall take all possible failure modes into consideration that cause gap in service operation of system, subsystem, equipment or part thereof. The calculation shall be based on the Contractor's submitted equipment MTBSAF and MTTR data and the configuration of each sub-system.
- (4) The overhead contact system design, arrangement and component design shall be chosen to ensure that the DFCCIL shall have high service availability.
- (5) The OHE design shall have mechanical independence of support for main line & where practicable for other lines. Adequate clearances shall be considered for designing to eliminate the chances of known short time interruptions due to Bird electrocution/ faults.
- (6) The arrangement of tension lengths and wire runs shall minimize the effect of overhead equipment damage in a station or crossover on neighboring sections, in the event of overhead contact or catenary wire failure.
- (7) TSS, SSP and ATS if any, shall be designed to a 100% availability level of N-1(First failure).
- (8) Circuit breakers are provided to operate on definite fault or over current conditions, and should isolate only the faulty section/ part or equipment of OHE and Power supply system ensuring healthy system is not affected.
- (9) Error detection and correction mechanism shall be included in the communication links as appropriate depending on the nature and functional criticality of the data conveyed.
- (10) Switchover between redundant equipment, or between redundant routings, shall occur automatically and immediately upon failure and shall be transparent to the users. Toggling in switchovers shall be prevented.
- (11) The Over Head Equipment (OHE) design shall have mechanical independence of support for main line & where practicable for other lines.
- (12) The complete SCADA system shall be designed to meet 99.99% hardware availability. The OCC equipment shall have 100% redundancy. All OCC equipment shall be supplied power from two independent sources of supply.
- (13) The OHE shall have Availability better than 99.5% and Traction Power Supply sub-system better than 99%.
- (14) Degraded performance or loss of any software or hardware dependent function of any end equipment shall be taken as unavailability.
- (15) The contractor shall assume in the calculations that the service operating hours are 20 hours per day (00:00 to 10:00) and 14.00hrs to 24.00hrs.for 365 days in a year or as decided by the Engineer.
- (16) It shall be possible to automatically re-energize the overhead line immediately following the occurrence of transient faults such as lightning, or bird strike causing a momentary short circuit. The auto-enclosure shall be of one shot only.
- (17) Save and except where specifically approved, failures of the overhead line, or support equipment shall not cause loss of traction supply to more than one line.

Provision shall be made, through section isolators/ interrupters/ Circuit breakers and other means, to allow reconfiguration of the traction power supply to feed the overhead line in areas not directly affected by the fault.

- (18) Mechanical joints of conductors, which may be susceptible to failure, shall, where practicable, not be located in close proximity to locations where there is an interface where the public have access. e.g. Adjacent Indian Railways Stations and level crossings. Locations where the public have reasonable access may be inspected by the Engineer prior to Energization of the electrical section.
- (19) Availability Demonstration
- i. The Contractor shall demonstrate the specified Availability during Service Trials and during the DLP. The Availability Demonstration Testing (ADT) shall be conducted on all Systems, subsystems and their interfaces.
 - ii. The demonstration test measure for Availability shall consider the performance of the Contractor's installed equipment, and the effectiveness of maintenance procedures recommended by the Contractor.
 - iii. The availability shall be worked out on the basis of the formula given during the preceding six months. In the event that the availability target as specified is not achieved, the Contractor shall,
 - (a) The determination of availability achievement in the preceding six month period shall be continued at monthly intervals until the target is achieved.
 - (b) The contractor at his own expense, will take action deemed necessary to meet the availability requirement

14.4 MAINTAINABILITY

- (1) Maintainability requirements and goals shall be developed in terms of Mean Time to Restore (MTTR) for all sub systems.
- (2) The MTTR shall include the diagnostic time, active repair / replacement time and adjustment / testing time, including software re-boot, up to the point the system is restored to full functionality. In the event that the failure cannot be rectified, the measurement shall include the time necessary to remove the failed piece of equipment from the System and replace it with a functional module.
- (3) The MTTR does not include the time taken for designated personnel to arrive on site (access time) to begin local diagnostic activities or the time taken for the replacement parts to be delivered at site.
- (4) Quantitative Maintainability assessments to all significant functional levels of the system, subsystems or equipment shall be allocated. Maintainability analyses during engineering, development and testing shall be used to evaluate the degree of achievement of the maintainability requirements. The Contractor shall identify the standards by which these allocations are made.
- (5) The System shall be suitably designed to minimize the need for frequent preventive maintenance.
- (6) Built-in self-diagnostics, power-up self-test and sufficient test points shall be provided in the System to minimize the time required to locate a fault. In addition,

especially the OHE System and the associated traction power cable network shall be so arranged that the corrective maintenance work can be easily carried out under accidental crippled operation.

- (7) All components, material, software and supports required for repair and servicing of the System shall be available during the entire lifetime of the System.
- (8) The system shall maximize the use of remote means to conduct maintenance, fault finding and fault rectification activities and to access maintenance information.
- (9) The Contractor shall select the Equipment & components to achieve the required level of Reliability, Availability and Maintainability with least MTTR matching with Industry benchmarks if any for approval of the Engineer.
- (10) The Power SCADA shall have an MTTR of less than 30 minutes. The Overhead Contact System shall have an MTTR less than 4 hours.
- (11) The Contractor shall identify and Describe/document the maintenance requirement for the overhead contact equipment.
- (12) The maintenance commitment in terms of frequency, number of personnel and specialist equipment shall be worked out by the contractor.
- (13) OHE maintenance in terms of quantum of work and its frequency, number of personnel, varieties of types and number of specialist items and spares, shall be minimum.
- (14) Repair facilities shall be provided to optimize speedy corrective maintenance by employing automatic diagnostics, test points etc. In addition, especially the OHE System and the associated traction power cable network shall be so arranged that the corrective maintenance work can be easily carried out under accidental crippled operation.
- (15) All OHE components including tensioning devices shall be installed with sufficient lubrication to prevent mechanical failure in service.
- (16) **Maintainability Demonstration**
 - i. The Contractor shall carry out tests to demonstrate that all maintainability predictions provided are met.
 - ii. The maintainability demonstration shall consist of simulated failures and repair activities, the duration of which shall be measured to determine the MTTR. As an alternative, data from actual maintenance actions for relevant independent failures occurring during the testing period may be used in lieu of simulation.
 - iii. A minimum of 50 maintenance actions shall be included for this demonstration.
 - iv. The maintenance actions shall be distributed among the equipment of each test group in proportion to their expected failure occurrence and in accordance with the MTBF.
 - v. In the event that any maintainability target is not achieved, the Contractor shall at his own expense take whatever action is deemed necessary to meet the maintainability targets.

- vi. The Contractor shall ensure that all the required information including the related Maintenance Work Instructions (MWI) etc. is available to enable him to demonstrate the maintainability targets.

14.5 SAFETY

14.5.1 General

- (1) Safety is defined as freedom from those conditions that can cause death, injury, occupational illness, or damage to or loss of equipment or property, or withdraw the train from service, which is considered as a risk in all circumstances susceptible to cause injuries or person death (passengers, operation staff, maintenance staff), and/ or by extension all events leading to a partial or total destruction of costly equipment.
- (2) The contractor shall be fully responsible for the system safety through the application of engineering and management principles, criteria and techniques to optimize all aspects of safety throughout all phases of the System life cycle.
- (3) During consideration of precedence in the control of system hazards, the Contractor shall take account of human limitations as an engineering constraint. The Contractor shall take actions to satisfy requirements in the following order of precedence:
 - (a) Incorporation of fail-safe or vital features which would allow the system to transfer from a high loss or risk mode to a lower loss or risk mode upon the occurrence of a critical failure; and,
 - (b) Reduction of the probability of occurrence of a failure by increased component reliability or by provision of supervised redundant components
- (4) Items relating to safety, contained within this Design Criteria and Standards, do not necessarily cover the full safety requirements.
- (5) The Contractor shall be responsible for addressing all of the issues relating to safety, compliant with Indian Railway safety regulations.
- (6) The design, construction, maintenance and monitoring of safety critical items, must be such as to guarantee safety at a level determined by the Contractor and presented to the Engineer for approval.

14.5.2 Safety Requirements

During each stage in the design and development process, the Contractor shall take cognizance of any hazard that arise as a result of the design or operation of the proposed equipment and take immediate steps to change the design or operation principals of the proposed equipment to mitigate the hazard.

All safety hazards shall be mitigated at the design stage where practicable.

- (1) The installation design shall incorporate measures to avoid presenting safety hazards.
- (2) The Systems design shall incorporate measures to provide for its safe management and operation.
- (3) The Systems shall not give rise, or be subject to, dangerous interactions within the railway or with other systems. Particular attention shall be paid by the Contractor

to the interface with the adjacent Indian Railways infrastructure.

- (4) The operation and maintenance of equipment inside the TSS, SSP and ATS shall satisfy the safety rules and system operation requirements of state power company.
- (5) The system shall have fail-safe features. The Contractor shall incorporate the SCADA earthing design requirements in the earthing and bonding management plan and design as described in this Particular Specification conforming to EN 50122-1.
- (6) The Contractor shall use safety devices to reduce the magnitude of the loss or risks once a hazardous mode has been entered; and ensure that the safety device does not introduce an additional hazard or system malfunction.
- (7) The Contractor shall use warning devices and systems which are audio/visual portion of a vital system in which the human is the responder. The Contractor shall recommend special equipment operating procedures to reduce the probability of a hazardous event. All automatic/ manual switchover between Main and Standby equipment shall be seamless and shall not affect the normal and emergency operation of the system
- (8) The Traction installation shall meet the fire safety requirements as per Indian Electricity Rule & National Building Code.
- (9) The design of the earthing system shall conform to IS 3043: 1987 (including latest amendments) and EN 50122-1, EN 50522, CBIP and IEEE-80:2013 as applicable to different parts of system.

14.5.3 System Safety Plan

- (1) The Contractor shall develop a System Safety Plan as an integral part of the design which shall be reviewed / approved by The Engineer.
- (2) The Plan shall address the general safety aspects associated with the OHE design and peripheral features.
- (3) The Plan shall include, Hazard Operability Studies (HAZOP) and Fault Tree Analysis (FTA) which shall fall into the following three categories:
 - (a) Subsystem hazard analysis (SSHA).
 - (b) Interface hazard analysis (IHA).
 - (c) Operating and support hazard analysis (O & SHA).
 - (d) Each of the above shall identify four degrees of risk:
 - (i) Catastrophic.
 - (ii) Critical.
 - (iii) Marginal.
 - (iv) Negligible.
 - (e) The above items related to safety do not necessarily cover the full requirements.
 - (f) It is the Contractor's responsibility to address all aspects of safety and comply with legislation.

- (g) The contractor should indicate mitigation measures for each hazard to keep the impact as low as reasonably practical (ALARP).

14.5.4 Quantified Risk Assessment

- (1) The Contractor shall prepare a Quantified Risk Assessment (QRA) to model the risk to
 - (a) public
 - (b) maintenance and operations staff
 - (c) Public and staff on the adjacent Indian Railways Line and other third party infrastructure.
- (2) The QRA shall address the risk of electrocution from the OHE and other equipment. For maintenance personnel key elements of the QRA shall include as a minimum an assessment of the risk of being struck by a train while working line-side, falls during maintenance, electrocution or injury due to crossing into Indian Railways territory. Accidental charging of dead section due to problem with SCADA and or due to other reasons and Interlocking posing safety hazard shall also be addressed.
- (3) The Contractor shall demonstrate that the Systems have been designed to minimize the risk due to operator and maintainer error, considering both the ergonomic aspects of the System design to reduce the likelihood of error, and protective measures are adopted to mitigate the consequence of such error.
- (4) The Contractor shall demonstrate that risk to public, including trespassers is as low as reasonably practicable.
- (5) The contractor should indicate mitigation measures for each hazard to keep the impact as low as reasonably practical (ALARP).

14.5.5 Risks on Functional Safety

- (1) The risks on functional safety System will include, but not be limited to, the following items:-
 - (a) Explosion or fire at TSS, SSP, ATS (if any), SCADA equipment room;
 - (b) Equipment safety;
 - (c) Damage to overhead conductors;
 - (d) Damage to overhead current collection system equipment;
 - (e) Damage to 25kV feeder and return cables;
 - (f) Electrical safety including safety clearance from exposed live conductors;
 - (g) Safety of the Engineer's staff and public, including trespassers as far as is reasonably practicable.
 - (h) Occupational repetitive injuries.
- (2) The Contractor shall minimize the above-mentioned risks to a level as low as reasonably practicable in the design and construction stages of System.
- (3) The contractor should indicate mitigation measures for each hazard to keep the impact as low as reasonably practical (ALARP).

14.5.6 Minimum Factors of Safety

- (1) The mechanical design of OHE, contact wire, catenary wire and other conductors shall take into account the permissible tensile stress, maximum temperature, allowable wear, wind loads, efficiency of tensioning devices, termination fittings, welded or soldered joints, additional vertical load in accordance with EN 50119 to allow adequate factor of safety under all conditions.
- (2) Structures and SPS, in combined tension/compression and bending, shall have safety factors in compliance with the appropriate design codes.

14.5.7 Hazard Log

A Hazard Log shall be established as a basis for on-going risk management. The hazard Log shall be updated with each event identified and mitigated. Residual Risk shall be carried forward and rules and procedures proposed to the Employer for the Management of such Residual Risk.

14.5.8 Hazard Analysis

- (1) The Contractor shall, as part of the safety analysis, prepare analysis to identify Hazards and ensure their satisfactory resolution. The following analysis shall be prepared and submitted by the Contractor for the Employer's acceptance:
 - (a) Preliminary Hazard Analysis (PHA)
 - (b) Subsystem Hazard Analysis (SSHA)
 - (c) Interface Hazard Analysis (IHA)
 - (d) Operating and Support Hazard Analysis (O&SHA)
 - (e) Quantitative Fault Tree Analysis (QFTA)
 - (f) Failure Modes, Effects and Criticality Analysis (FMECA)
- (2) The Contractor shall carryout the Hazard Analysis and FMECA/FTA for key equipment / sub-systems / systems. As a result of hazard analysis, the Contractor shall:
 - (a) Identify and list the hazards
 - (b) Identify and list the Safety Requirement Specifications
 - (c) Identify and list the safety related functions
 - (d) Specify for each safety related function the safety related failures
 - (e) Identify and list the safety critical and non-safety critical items.
- (3) The hazard analysis shall address the risk of electrocution from the OHE and other equipment. For maintenance personnel key elements shall include, as a minimum, an assessment of the risk of being struck by a train while working line-side, falls during maintenance, electrocution or injury due to crossing into Indian Railways territory. Accidental charging of dead section due to problem with SCADA and or due to other reasons and Interlocking posing safety hazard shall also be addressed.
- (4) The functional safety risk analysis translating to category of Hazards will include but not limited to the following:-
 - (a) Explosion or fire at TSS, SSP, ATS (if any), and SCADA equipment room;

- (b) Equipment safety;
 - (c) Damage to overhead conductors;
 - (d) Damage to overhead current collection system equipment;
 - (e) Damage to 25kV feeder and return cables;
 - (f) Electrical safety including safety clearance from exposed live conductors;
 - (g) Safety of the Engineer's staff and public, including trespassers as far as is reasonably practicable.
 - (h) Occupational repetitive injuries.
- (5) The Hazard Review Procedure shall be submitted for the Employer's approval. The final risk assessment, acceptance of mitigation and close out of hazards shall conform to the approved safety and risk acceptance criteria.
- (6) The following targets/norms shall be employed for the Fault Tree Analysis. These norms are subject to review by the Engineer during the detailed design stage, and mutually agreed upon:
- (a) No single point failure shall lead to fatality.
 - (b) No combination of undetected failure and double point failures shall result in fatality.
 - (c) No combination of undetected failure and single point failure shall result in major injury.
- (7) The Hazard Log shall be substantially complete prior to commencement of Trial Running and shall be handed over to the Engineer complete in all respects prior to the commencement of Revenue Service.
- (8) The Contractor shall fully develop a Safety Critical Items List (SCIL) which shall be updated as required and carried forward throughout implementation until final resolution of identified hazards is achieved.
- (9) The design, construction, maintenance and monitoring of safety critical items, must be such as to guarantee safety at a level determined by the Contractor and presented to the Engineer for approval.
- (10) Further, the information presented by the Contractor shall be supported by the history of tests conducted and by approved test certificates from accredited laboratories which attest to the engineering program characteristics and behaviour.
- (11) The procedures for Operation, Maintenance, Training and the Contractor Quality Assurance manuals shall incorporate resolution of hazards so identified from this Hazard Analysis. Proper cross-referencing to the hazards and resolution measures shall be provided in all these aforementioned documents.

14.5.9 Design/Systems Safety Studies and Report

The Design/Systems Safety Studies and a Report shall be submitted at the completion of the Detailed Design period to confirm that all safety related aspects of design have been properly addressed and comprehensively validated.

14.5.10 Engineering Safety Validation Plan and Report

- (1) The Contractor shall submit Engineering Safety Validation Plan to demonstrate

that the system has been designed to minimize the risk due to a hazard and protective measures have been adopted to mitigate the risk.

- (2) The Engineering Safety Validation Plan will outline the safety related tests to be conducted during the on-site testing and integrated system testing phase. The document will include the validation of the safety requirements for the system. Throughout this document details test cases carried out in order to validate the system, the relationship of the effects found in these tests and the validation of the same in subsequent tests will ensure that the system comply with the safety requirements.
- (3) The Contractor shall demonstrate that the sub-systems have been designed to minimize the risk due to operator and maintainer error, considering both the ergonomic aspects of the System design to reduce the likelihood of error, and protective measures are adopted to mitigate the consequence of such error.
- (4) An Engineering Safety Validation Report will be submitted after the completion of this testing.

14.5.11 Relational Database Management System

- (1) All hazard resolution by procedural control shall be cross-referenced from the safety critical and non-safety critical Items List to the appropriate manuals. The results of the Hazard Analysis shall be recorded and maintained by the Contractor in a Hazard Log in the form of a relational database that can be used to track progress in the implementation of mitigating actions and control measures, and provide an easily accessible reference for the future Operator of all actions taken with respect to any hazard of any type in an any location for any area of activity. Proper cross-referencing to the hazards and resolution measures shall be provided in all these afore mentioned documents.
- (2) The fully functional soft copy of the relational database management system shall include together with all passwords, supporting software and instructions on its use and further development during Revenue Service.

14.5.12 Ram Demonstration

(1) RAM Demonstration Plan

- i. The Contractor shall submit RAM Demonstration Plan to the Engineer for approval before the final design review to demonstrate that all RAM predictions and specifications are met.
- ii. The requirements relating to Maintainability shall be demonstrated before the commencement of Trial Running and may begin as soon as the necessary systems or elements of systems have been tested and commissioned.
- iii. The requirements relating to Reliability and Availability shall be demonstrated throughout Trial Running Period and the Defects Liability Period.

(2) Failure Reporting and Corrective Action System (FRACAS)

- i. The Contractor shall be required to establish a computer based Failure Reporting and Corrective Action System (FRACAS) during the RAM Demonstration phase. The FRACAS proposed by the contractor shall need the approval of the Employer.

ii. The FRACAS will:

- (a) Provide a process for reporting, classifying, analyzing failures, and planning corrective actions in response to those failures.
- (b) Collect data, record and analyze system failures.
- (c) Produce a history of failure and corrective actions.

14.5.13 System Assurance Submissions

Deliverable Documents

The Contractor shall implement and submit system assurance supporting documents in accordance with the approved System Assurance Plan which shall include, but not be limited to, the following documents at the times indicated in the table below.

S No	Document Description	Plan Development Stage					Remarks
		Design Stage		Manufacture/Construction/Installation	Testing/Trial Run Stage	Warranty Stage	
		PRELIM	FINAL				
1	System Assurance Plan (included System RAM Plan and System Safety Plan)	P					Shall be submitted within 56 days after the Commencement Date
2	System RAM Plan		U	U	U		
3	System Safety Plan		U	U	U		
4	Safety Policy	P					Shall be submitted within 56 days after the Commencement Date
5	Hazard Analysis and Hazard Log	P	U	U	U	U	First report shall be submitted within 28 days after the preliminary design completion. The report to

S No	Document Description	Plan Development Stage					Remarks
		Design Stage		Manu- facture/C onstruc- tion/Inst allation	Testing/ Trial Run Stage	Warranty Stage	
		PRELIM	FINAL				
							include Safety Requirements Specifications and Safety Critical Item List (SCIL).
6	Design/ Safety Studies and Report		P	U	U		First report shall be submitted within 28 days after the final design completion. The report shall at least include the Safety Requirement Specification, Hazard Log, Deterministic Safety Assessment, Quantitative Risk Assessment, Safety Integrity Level Analysis, Failure Mode, Effect and Criticality Analysis, Reliability Block Diagram
7	RAM Analysis and Prediction Report		P	U	U	U	First report shall be submitted within 28 days after the final design completion. Report will also include RCIL

S No	Document Description	Plan Development Stage					Remarks
		Design Stage		Manufac ture/C onstruc tion/Inst allation	Testing/ Trial Run Stage	Warranty Stage	
		PRELIM	FINAL				
							and MCIL.
8	FMECA		P	U	U	U	First report shall be submitted within 28 days after the final design completion
9	RAM Test / Demonstration Plan		P	U	U	U	First report shall be submitted within 28 days after the final design completion. The demonstration plan shall include the proposed FRACAS system.
10	RAM Test / Demonstration Report				P	P	- Reports shall be submitted separately within 28 days after each completion of demonstration tests in terms of maintainability demonstration test, and availability / reliability demonstration test. - Monthly RAM Demonstration Records and Reports shall be

S No	Document Description	Plan Development Stage					Remarks
		Design Stage		Manufac ture/C onstruc tion/Inst allation	Testing/ Trial Run Stage	Warranty Stage	
		PRELIM	FINAL				
							submitted at the 7 th day for prior month ending during Defect Notification Period
11	Engineering Safety Validation Plan		P	U	U		First report shall be submitted within 28 days after the final design completion
12	Engineering Safety Validation Report				P		Shall be submitted within 28 days after completion of safety validation test
13	Operational Safety Case	P			P		Second report shall be submitted within 28 days after the completion of safety validation test

P - Document Produce

U - Document Update

(End of Chapter 14)

CHAPTER 15 - SUPERVISION AND PLANNING OF MAINTENANCE

15.1 GENERAL

The requirements of supervision and planning of maintenance are to be complied as per Employer's Requirements, Part 2, Section VI, Vol-1, and Chapter 14: Operation & Maintenance Spares, and Tools & Plants of General Specifications and as per specifications / provisions mentioned below:

15.2 SUPERVISORY STAFF

The Contractor shall provide Competent supervisory & maintenance staff in adequate numbers, having expertise in fault finding, maintenance & repair of the various systems supplied under the Contract for full time appropriately positioned to report at point of assembly/ depot, during any fault to attend during entire Defect notification period, as extended if any, covering at least the following areas of excellence:-

- (1) Traction substation (132kV, 25kV) including SSP
- (2) 2x25kV/1x25kV flexible OH system
- (3) SCADA System
- (4) E&M system

15.3 CONTRACTOR'S OFFICE DURING DEFECT NOTIFICATION PERIOD

Contractor shall establish and maintain the 'Maintenance office(s)' manned with the supervisory and maintenance staff with a Dedicated Desk Officer to attend the calls of the Employer's Personnel and inform their Head of Maintenance who would promptly act to attend the emergencies/ maintenance calls including organizing of all the resources i.e. artisans and Material.

The Contractor Shall Maintain a computer based FRACAS system to log all the events of Failure.

15.4 MEN & MATERIAL REQUIRED DURING DEFECT NOTIFICATION PERIOD

The contractor shall resource the required staff and Material during the Defect Notification period at their own cost 24hrs all 7 days of every week to attend the Defects. The deployment of staff shall be approved by the Engineer. The Material if any used from the spares shall be made good. The contractor shall arrange all the Tools & Plants needed to attend the defects during the Defect Notification period.

(End of Chapter 15)

CHAPTER 16 - TRAINING

16.1 GENERAL REQUIREMENTS

The Contractor shall provide comprehensive training to the Employer's personnel in accordance with the requirements contained in this PS and as per Employer's Requirements, Part 2, Section VI, Vol-1, and Chapter 13 – Training & Transfer of Technology of General Specifications and as per specifications / provisions mentioned below:

16.2 TRAINING PLAN

16.2.1 The training plans shall be developed as per provisions in the General Specifications and submitted to Engineer for review and approval. The plan shall also include but not limited to the following:

16.2.2 The training shall be carried out at such locations where the greatest benefit for trainees may be gained. The training will include the Training/ exposure at OEM's Manufacturing Place to give the exposure / hands on experience to the technology, manufacturing process, assembly and quality & Test Checkpoints and sensitise the trainee on the quality and test procedures so that similar standards can be replicated at Place of Maintenance. This may be in India, abroad, at place of manufacture, assembly or testing, or at such other locations as may be necessary. All proposed places of training shall be subject to review by Engineer.

16.2.3 The Training Plan shall include training at plant / manufacturer works as above and shall include 150 man-days at OEM's Place. The plan shall also include visit to different places, work- areas plants. The cost of travel and stay shall be borne by the Employer. The training should also include 150 instructor man-days to impart training at work site.

16.2.4 The training plan should include subjects like Condition Based maintenance to reduce the down time of equipment/ system and maintenance cost. The plan should also cover the details of equipment/ instruments required for monitoring the condition / health of the equipment / system.

16.3 MOCK UP FOR TRAINING

16.3.1 The Contractor shall install mock up equipment for system and any such facility(s) considered necessary for the training of Employer's personnel.

16.3.2 The training mock up shall include but not limited to the following: -

- (1) OHE system components
- (2) Contact, messenger and aerial earth wires;
- (3) Section insulator;
- (4) Jumper and cable connections to OHE;
- (5) Rail bonds and cable rail connections of return circuits;
- (6) Circuit breakers and Interrupters and their component assemblies;
- (7) Isolators;
- (8) SCADA training Aids such as RTU, PCU and OCC.

- (9) Cut Sections of Circuit breakers, cables
- (10) Cut sections of Gas Insulated switchgear
- (11) Clear photographs of various equipment such as transformers, their windings, rectifier and inverter sets;
- (12) Samples of various clamps and fittings used;
- (13) Control panel, protection schemes, earthing and bonding arrangement;

16.4 TRAINING OF EMPLOYER'S TRAINING INSTRUCTORS (ETI)

16.4.1 The Contractor shall provide training to the Employer's Training Instructors on the various Systems. Aspects covered shall include, but not be limited to, the following:

- (1) Configuration of the entire System, including interface with IR's Transmission Network supply system at the feed point
- (2) Feature and functional principles of the entire System;
- (3) System design aspects including but not limited to design standards, design criteria and parameters, short-circuit and other calculations, Insulation and protection co-ordination;
- (4) Details of major equipment and material including but not limited to 132kV, 25kV, circuit breakers, interrupters, isolators, voltage and current transformers, OHE conductors, fittings, assemblies and protection relays, batteries and chargers, and cables of different types and their joints used in the System;
- (5) System operation and maintenance management and procedures;
- (6) SCADA System; and
- (7) Earthing and bonding arrangement, covering safety aspects of touch and step potential safety to personnel, passengers and outsiders.

16.5 OPERATIONS STAFF TRAINING

16.5.1 The objective of the training is to enable the Employer's operations staff to be familiar with the Systems, with focus on the operational aspects under normal and emergency conditions.

16.5.2 The training shall also enable the trainee to acquire full capability for identification, trouble shooting and rectification of faults in the specified duration. After classroom training which includes mock-up of equipment, the staff shall be trained in actual operation.

16.6 COMPUTER BASED TRAINING (CBT)

16.6.1 The Contractor shall submit, for the Engineer's review, the following CBT information documents:

- (1) Operation of the TSS, SSP power Systems;
- (2) Maintenance of TSS, SSP power Systems;
- (3) Operation of OHE including return feeder System;

- (4) Maintenance of OHE including return feeder System.
- (5) Operation of SCADA System;
- (6) Maintenance of SCADA System.

16.6.2 The CBT Information Document on Operation of individual System shall contain, but not be limited to, the following:

- (1) General introduction of the System, its functionalities and objectives (including the RAMS requirement);
- (2) Single line diagrams;
- (3) Description of the System operation principles, for both normal and emergency operation conditions;
- (4) An overview on the System configuration, including interface with other agencies;
- (5) General description of the functions of each key equipment and components of the System with photographs showing the appearance of each of them, where they (Key equipment and components) are located throughout the DFC;
- (6) List of potential hazards that may arise in operating the System;
- (7) Any specific points to note in operating the System to ensure safety to personnel (the Employer's staff and members of the public) and equipment, and;
- (8) Electric shock treatment.

16.6.3 The CBT Information Document on Maintenance of individual System shall contain, but not be limited to, the following:

- (1) General description of the functions of key components of the System, with photographs showing the appearance of each of them;
- (2) A general description of the proposed maintenance strategy of the System and major components;
- (3) The maintenance plan and procedures proposed for the System and major components in accordance with the MMS;
- (4) CBT as per the levels of maintenance activities required for the System and major components.
- (5) An introduction to the special tools and equipment required for maintaining the System and major components;
- (6) Tests to be conducted after maintenance and the test equipments required.
- (7) A description of the symptoms of the common faults found on the System;
- (8) Simulation of faults on the entire System, and how to promptly restore the system; and
- (9) Other points to be noted in effectively maintaining the System.

16.7 TRAINING AND TRANSFER OF SKILLS

16.7.1 The training shall broadly cover the following aspects :

- (1) Flexible OHE;

- (2) SCADA System;
- (3) Protection and Control;
- (4) Gas Insulated Switchgear if used
- (5) Traction Power Supply equipment.

16.7.2 After training the personnel should achieve satisfactory skills and capabilities as under but not limited to:

- (1) Identification of various cards and components of RTU
- (2) Erection, wiring and commissioning of RTUs and trouble shooting of RTUs
- (3) Configuration of addresses of RTUs, future expansion and setting up of additional tele-commands, tele-signals.
- (4) Using the test instruments to check the communication cable performance parameters
- (5) Operation of SCADA software and HMI display functions
- (6) Formatting of Hard Disk, loading of the operating system, loading of the basic SCADA application software and taking back up of files
- (7) Operation & maintenance instructions recommended by OEMs of different SCADA subsystems.
- (8) Skills in special aspects of repair and maintenance of Traction Transformers and Auto- transformers.
- (9) Skills in special aspects of repair and maintenance of installed equipment of 132kV, 2x25kV and 25 kV switchgear etc.

16.7.3 Methods of Training shall include Class room training, audio visual aids, mock up, samples, site visits to OEM's Place, and/or places of Installation where such equipment and components are used by any other client of the vendor/ Manufacturer.

(End of Chapter 16)

CHAPTER 17 - OPERATION AND MAINTENANCE DOCUMENTATION

17.1 GENERAL

- 17.1.1 The Contractor shall provide Operation and Maintenance documentation as per Employer's Requirements, Part 2, Section VI, Vol-1, Chapter 14 – Operation & Maintenance, Spares , Tools & Plants of General Specifications.
- 17.1.2 Operation and Maintenance & other Manuals for Installed system to provide all necessary information on traction power supply, all equipment from 132kV TSS incomer/ traction substations, through 25kV AT Feeding System and Over Head contact line Equipment (OHE) system, complete with a central supervisory control and data acquisition system (SCADA) for Monitoring & Control of Dadri – Khurja section of Eastern DFC including but not limited to:
- (i) System configuration/ scheme and major subsystems & components,
 - (ii) System Architecture and Redundancies,
 - (iii) Contingency Scenarios and Mitigation Measures,
 - (iv) Performance Parameters for stringent application duty scenario,
 - (v) Monitoring, Control and Protection system,
 - (vi) Environmental and Operational Parameters for the Electric Traction system,
 - (vii) Reliability, Availability, Maintainability and Safety benchmark, Performance Parameters benchmarks including compliance and demonstrations at design and operational stage,
 - (viii) Design & Drawings,
 - (ix) Producing Combined Service Drawings (CSD) and Interface with the 132 KV Transmission Line Network of the Indian Railways, and with the associate sub-systems such as rolling stock, train control system, signaling, communications, operations and maintenance requirements, track form, track alignment, depot and station layouts and civil infrastructure,
 - (x) Site execution requirements including Safety, Health, environment Construction Machinery and Methods; Gadgets, Wiring Trains and Inspection Cars and Testing & Commissioning,
 - (xi) Procedures and Statutory Approvals.

(End of Chapter 17)

CHAPTER 18 - INTERFACE MANAGEMENT

18.1 GENERAL

- 18.1.1 This chapter outlines the Contractor's interface requirements between Systems Contractors (CP-105), - other contractors of EDFC and WDFC projects, Indian railways and State regulation authorities etc. These are generally based on the technical studies carried out during the early stages of the Project.
- 18.1.2 The Contractor shall maintain a close interface with relevant authorities, Contractors and agencies to ensure the time bound completion of this project and to ensure that all requirements of the General Specifications and Particular Specification pertaining to interface are fully resolved and implemented.
- 18.1.3 The Interface requirements as described in this document are by no means exhaustive and are for reference only. It is the Contractor's responsibility to develop, update and execute jointly an "Interface Management Plan" for defining responsibilities and to exchange information in order to achieve/comply the interface requirements before the commencement of the Work and throughout the execution of the Project work to ensure that:
- (1) All interface issues between the Contractors are satisfactorily resolved;
 - (2) Supply, installation testing & commissioning, operation and maintenance of equipment are fully coordinated; and
 - (3) All equipment and facilities supplied under the Contracts are fully compatible and integrated with each other, whilst meeting the requirements of the respective Specifications.

18.2 OBJECTIVE

- 18.2.1 The design and construction of new freight Railway lines (EDFC), is a complex multi-disciplinary project, requiring close interaction and co-ordination between the various Contractors.
- 18.2.2 An 'Interface Matrix' is developed to define the interface requirements and demarcate the jurisdiction. The objective of the "Interface Matrix" is to identify the activities of scope of work to avoid conflict amongst different contractors, which could possibly minimise and facilitate hassle free execution of works.
- 18.2.3 This document outlines the interfacing requirement during the execution of the works. However, the requirements herein specified are by no means exhaustive and it remains Contractors' responsibilities to develop and execute jointly an interface management plan throughout the execution of works to ensure that:
- a. All interface issues between the Systems Contractor (CP-105), Civil, Building & Track Contractors (CPs-302 & partly 303), Systems Contractor (CP-104), Systems Contractor (CP-305), CTP-14 Contractor of WDFC, IR / PGCIL and other related agencies are satisfactorily identified and resolved ;
 - b. All the Construction tolerances at the interface shall meet the requirements of the respective specification,
- 18.2.4 This "Interface Matrix" shall be read in conjunction with the relevant provisions of the Contract Specifications. The Contractor (CP - 105) and the other Interfacing Contractors

shall be responsible for compliance of all requirement of the Specification in terms of the defined scope of work of the Parties.

- 18.2.5 Notwithstanding the requirements described elsewhere in the contract regarding the precedence of document, the provision contained in the drawings and elsewhere in the particular specification shall prevail over the provisions contained in this Interface Matrix.
- 18.2.6 Interface requirement for access to works for provision of Traction power supply and 2x25 kV, AC OHE works involving space for traction structures along the tracks, on bridges / viaducts for OHE, Location of signals, as well as of switching off of locomotives at neutral sections and finally system proving tests etc.
- 18.2.7 The Employer/Engineer shall organize coordination meetings to resolve all interfacing issues amongst the Contractors. In addition, the system wide Contractor may also arrange his own coordination meetings with the Other Contractors.

18.3 INTERFACING REQUIREMENTS

18.3.1 The following is an indicative list of the Contractors with whom the Contractor (CP-105) shall essentially interface. The List is not, however, exhaustive and the System Works Contractor (CP-105) shall ensure that any site problem, as and when it arises, is clearly and conclusively discussed with the appropriate Agency and solutions arrived at.

- (1) Civil, Building and Track Work Contractors ; (CST); (Package 302 & partly 303)
- (2) Systems contractors of CP 104 i.e. contractor of adjacent New Bhaupur – Khurja Section for electrification and SCADA – OCC work interface.
- (3) System Contractor CP 305 i.e. contractor of adjacent Khurja – Pilkahani Section for electrification interface at Khurja end.
- (4) CTP 14 contractor of WDFC for Traction Electrification works for interface at Dadri end.

18.3.2 In addition, the Contractor (CP-105) is also required to interface with the

- (1) Indian Railways (Northern Railway and North- Central Railway zones),
- (2) Indian Railways-cum-PGCIL for 132 kV Power Supply,
- (3) Statutory bodies like local civil authorities, public utility companies, and
- (4) Those who are considered to be related with the work.

18.4 INTERFACE

18.4.1 Interface With Civil, Building & Track Contractor (CST)

1) Items Of Interface

The System Works Contractor (CP-105) shall be responsible for the design, procurement, delivery at site, installation, testing, commissioning, support, operation and maintenance, and setting to work for Overhead Electric Traction System and related wayside switching station equipment and facilities.

Interfacing with Civil, Structure and Track (CST) contractor will be required for -

- a) Information regarding track alignment, cant, versine, track geometry, rail levels, gradient, curve details, track center along with transition curve

details.

- b) Access to site on main line, substations, switching stations (SSP), Auto Transformers, Isolators, Interrupters etc. ,
- c) Path, access road to site
- d) The System Contractor may please note that no movement of men and material will be permitted on the embankment after the blanket layer upto the designed thickness is finished.
- e) Access& ROW of Rail Track to facilitate movement of Material train and Tower Wagon to finish Wiring & adjustments of the conductors.
- f) Earthing & Bonding connections between AEW, Masts, Rails, all non-current carrying structures including BEC as required as per the Schematic attached.
- g) Providing earth continuity in reinforcement bars of girder /concrete bridge and earth terminals at either ends on end sections.
- h) Providing HDPE/ GI pipes below tracks of requisite size for track-crossing of traction cables.
- i) Providing continuity bonds in track, particularly at points and crossings.

2) Information Exchange

The Electrical contractor (CP-105) shall exchange all the information with the CST contractor regarding the information on the Traction Power Return System (TPRS) and the Traction Power Distribution System (TPDS) i.e. OHE and its supports and the sequence of the execution. The Details shared shall be read in conjunction with the Technical Specifications shared by the Contractor (CP-105).

3) Interface requirements

The Interface requirements are described in Table-18.4.1

Table-18.4.1

Indicative Interfacing Matrix with Civil, Buildings and Track Works Contractors (CP 302 and 303)

Item No.	Item Description	Systems Works Contractor (CP-105)	Civil, Building & Track Contractor (CST)	Locations
1.	Information exchange on alignment with following details: a) Track Formation Cross section b) <u>Track alignment Drawing</u> c) <u>GPS coordinates of track Centre</u> d) Curves e) gradient f) <u>Rail levels.</u> g) Storm water & natural drainage etc. h) Track layout	Based on the information of track geometry received from CST : - Shall carry out detailed survey and verify the alignment drawings, Centre line, cross sections, track geometry at main line and junction station yards, and advise the respondent regarding infringements and modifications if any, - Shall develop Traction System Design & drawings /diagrams with consideration to the data shared by CST contractor - Shall prepare General Arrangement Drawing (GAD) and layout plans for traction supply installations and OHE of main line Junction / crossing stations, yard and siding including finalization of the Foundation Design & Drawings.	Shall provide final Track alignment drawings & plans, details of track geometry /structure, curves, gradients and Rail levels etc. along with details on storm water drains for the main lines & junction stations Shall share with Contractor (CP-105), the GPS coordinates of Centre lines of tracks as finalized and approved by the Engineer. Shall share track work design details with Contractor (CP-105). Shall share the information with the Contractor (CP-105) within the specified schedule to achieve the targeted Milestone	All locations throughout the Alignment
2	Completion of Track activities essential for commencement of Physical work at site for each section a) <u>Finishing of Blanket layer</u> b) Completion of Track fit for movement of Tower wagon, Mechanized wiring Train and Material Train to Transport masts etc.	Shall Coordinate with the CST contractor and shall maintain a coordinator to continuous liaise with them, conduct meetings and seek information and keep the Engineer informed regarding completion of Blanket layer, Track fit for movement of Tower Wagon, Mechanized wiring Train and Material Train, stabling lines and Plan for Construction activities as per the Delivery schedule	Shall share the work programme of and Date of Completion of following activities for section ranging between continuous lengths of 10-20 km within 90 days of award of Contract (CP-105) for Electrical Works: (a) Finishing of blanketing layer. (b), (c) & (d) Completion of track fit for movement of tower wagons, mechanized wiring trains and material trains the access of which shall generally be made available to	Along the route,

Item No.	Item Description	Systems Works Contractor (CP-105)	Civil, Building & Track Contractor (CST)	Locations
	c) Track connectivity Mechanized wiring Train stabling and Tower wagon shed d) Completion of Tower wagon shed	Shall take the access to the Blanket layer, Rail track and stabling siding for execution of the work.	the System Contractor by the CST contractor Shall coordinate with Contractor (CP-105)	
3	Provision of OHE masts / anchors locations.	Shall issue 'the pegging plans' indicating the locations of OHE masts / anchors. Shall assess the Soil Bearing capacity, Moisture content and measure earth resistivity and improve the same if earth resistance exceeds 25 Ohms. Shall design & construct the foundation conforming the track bed profile without exposing any portion of the Foundation, covering and protecting unavoidable portions of Exposed foundations.	Shall advise about infringements to the Track alignments, anchoring limitations to the structures, restrictions to exposed foundations and advise for correction if any. Shall share the embankment design Data.	Mainline and sidings
4.	Right of Way (ROW) and Access to site: a) main line, substations, switching stations SSP/ATS, b) Junction/ station, yards, temporary sidings and storage space along the route for construction activities.	Shall hold interface meetings to settle such locations & sizes, spaces for access route required /available as per site conditions for a) main line for movement of construction staff &Material, b) substations from Road and Tracks, c) switching stations SSP/ ATS if any, d) Junction/ station, yards, temporary sidings and storage space along the route.	Shall not temper the natural ground to be used by other contractor for their activities such as Construction of TSS, SSPs. Shall not encroach/obstruct land or access routes earmarked for construction activities of other contractors as handed over by DFCC or CST contractor. Shall complete all the activities i.e. Blanket layer and Track laying etc. in coordination with the construction activities of System Contractor (CP-105) to meet the timeline. Keep the space/ ROW earmarked for exclusive/ shared use for movement of Material to the construction site i.e. TSS and SSP, Junction/ station, yards, temporary sidings and storage space along the route.	Main Line & sidings, Substations, Switching Stations, Junction Station and approach roads

Item No.	Item Description	Systems Works Contractor (CP-105)	Civil, Building & Track Contractor (CST)	Locations
5	Provision of approach road to the construction sites from Junction station	Shall coordinate with DFCC and the relevant contractors for access routes to connect the construction sites with the Junction station/ available point and utilize as per the requirement including making fit for purpose Shall use the ROW / access as earmarked for the use by the Engineer	Shall share the access routes with other contractors as approved by the Engineer.	All stations to TSS, SSP,
6.	Provision of GI/HDPE pipes below tracks for crossing of power cables across tracks at locations near substations, switching stations, Junction stations, yards	Shall provide schematic drawings showing specific locations, GI/HDPE Pipe sizes and number of pipes as required for cable crossing, across tracks to CST generally conforming the Typical Schematics of Bid Documents. Shall coordinate with CST contractor and confirm suitability of locations and share all the information to facilitate laying of pipes / cables as per requirement.	Shall co-ordinate with system contractor to provide access for laying of GI / HDPE pipes as required below track as per requirement for Cable Crossings etc. as approved by the Engineer.	Main Line, Substation, Switching Stations, Junction Station
7.	Provision of Buried Earth Conductor(BEC) as required and Earthing & Bonding connections Longitudinal to the Alignment, Connections & terminals including crossing under the tracks	Shall supply and install (continuous) Buried Earth Conductor (BEC) as required all along the alignment buried in soil within formation including crossing under the Track (wherever required) and bring out connections with terminals above ground. Shall provide connections/extensions through welded lap joints/ exothermic joints as approved by The Engineer. Shall provide schematic drawings and designs showing profile/ size & Material Specifications of BEC as required, Typical laying arrangement longitudinal to the	Shall allow the Cad-weld connections to the BEC/ terminals as required by the Systems Contractor (CP-105).	Main Line, Substations, Switching Stations, Junction Station

Item No.	Item Description	Systems Works Contractor (CP-105)	Civil, Building & Track Contractor (CST)	Locations
		alignment, brought out Connections above ground with terminals, crossing under the track including earthing & bonding Joints, connection with Rails. Shall coordinate with the Civil contractor so that the BEC is installed while the formation work is in the progress by the Civil Contractor and formation is not required to be excavated for laying of BEC.		
8.	BEC connection to Rails	The Contractor (CP-105) shall share the information regarding the requirement of jointing with rails for connecting with BEC Terminals Generally the BEC connection to the rails shall be through Exothermic Joint. The Contractor (CP-105) shall share the information regarding the places where There is least possibility of making Exothermic joints and requesting for the Bolted Connections to allow the drilling of holes in Rails.	The CST Contractor shall share the Technical specifications of Rail. Shall accommodate the requirement of Drilling of Holes in Rails/ Exothermic joints with Rails Shall ensure availability of the supervising team to permit the drilling in rails including Exothermic joints including the guidance as may be essential to ensure least damages to the rails.	Mainline, Yards
9.	Earthing of metallic structure in parallelism with OHE	Shall Provide earthing & bonding of all metallic structures in parallel with OHE by means of two separate and distinct connections with BEC as required,.. Shall interface and get all drawing and scheme signed by Employer's Engineer ascertaining adequacy of earthing and bonding requirements.	Shall provide drawings of fencing and other metallic structures running along the track for long distances. Shall coordinate with CP-105 contractor for making earth connection with metallic structures as per approved design/drawings	Main Line, Substation, Switching Stations, Junction Station

Item No.	Item Description	Systems Works Contractor (CP-105)	Civil, Building & Track Contractor (CST)	Locations
10.	Bridges (Concrete / Metallic) OHE Load on the Pier cap of bridges due to OHE Masts/Anchors etc.	<p>Shall provide OHE Layout Plan (LOP) of proposed locations of OHE Masts and Anchor locations.</p> <p>Shall get approved from the Engineer; the schematic drawings and specification showing the arrangement of Holding Down Bolts (HDB) for OHE mast and anchor at Bridges</p> <p>Shall coordinate with CST contractor and confirm for suitability and extend all assistance for making Holding Down Bolts (HDB) as per approved design/drawings.</p> <p>Shall also share values of Max direct load, Bending Moment, etc. arising due to the OHE Masts, fittings and anchors, which have to be considered in the design of Piers.</p> <p>Shall provide staff to witness the provisions made by the CST contractor for adequacy and suitability. Shall amend the design & install the OHE system appropriately as per the provisions available on the bridges finally executed.</p>	<p>Shall take into account the OHE mast location, loads and bending moment etc. and ensure that the Pier Cap which are to receive the OHE Mast and Anchor etc. are suitable designed.</p> <p>Shall cater for the OHE provisions as approved by the Engineer.</p> <p>Shall supply and cast the necessary Holding Down Bolts in concrete as per approved scheme and design as approved by the Engineer.</p> <p>Shall provide rubber sleeves over threaded part of holding down bolts to avoid from damage.</p>	Bridges
11.	Electrical Clearances at Bridges (FOB, ROB) Over – Line Structures above tracks or OHE	<p>Shall interface for infringements to SSOD if any and Electrical Clearances and required modifications / improvements.</p> <p>Update /modify traction OHE drawings based on the interface information.</p> <p>Shall interface and get all drawing and scheme signed from the Engineer ascertaining adequacy of electrical clearance as per approved design/drawings.</p>	<p>Shall supply list of Over – Line Structures (FOB & ROB) indicating specific locations, cross-sections, height above Rail level and dimensions details for evaluation of infringements, if any.</p> <p>Shall accommodate the requirement of the Contractor (CP-105) as approved by the Engineer.</p>	Bridges
12.	Earthing and bonding of over	Shall provide schematic for Earthing &	Shall accommodate the requirement of the	Bridges

Item No.	Item Description	Systems Works Contractor (CP-105)	Civil, Building & Track Contractor (CST)	Locations
	Line Structure -Bridges – Metallic (including FOB, ROB)	Bonding of bridge (metallic if any) with BEC as required. Shall provide earthing of over line structures (metallic if any) with BEC as required.	Contractor (CP-105) as approved by the Engineer for making earthing & bonding connections of Over Line Structures(metallic if any),	
13	Earthing & Bonding of bridges / Viaduct. – Concrete	Shall provide schematic for earthing & bonding connections with dedicated reinforcement bars in concrete of Piers cap to Piles/legs of concrete Bridges. Shall interface and get all drawings & scheme approved from the Engineer. Shall supply and Install flexible cable / jumper and connect the Terminal plates with BEC as required at every consecutive spans. Shall arrange adequate supervision of appropriate level and at various stages of construction to ensure the provisions of earth continuity in the concrete structures.	Shall install dedicated reinforcement earth bars in concrete to ensure earth continuity as per approved scheme. Shall coordinate with system contractor to provide necessary arrangement for earthing. Shall provide Main Earth Terminal(Lugs) as per reference drawing "OHE Mast on Embankment' under Part-4 Reference Document.	Bridges & Viaduct
14	Bridges -Cable Duct/Trough for making arrangement for cable power and control cables on Bridge.	Shall provide requirement for cable supports / ducts/ troughs along the bridge length. Shall lay cables in the Cable supports/ trough/ ducts. Shall provide manpower to apprise the CST contractor at appropriate stage to cater for the provisions required by OHE contractors	Will provide the Cable trough, ducts, cable supports and hangers as per the designs and drawings as approved by the Engineer.	
15	Bridge- HDPE / GI Pipe below track for crossing the track on Bridge	Shall prepare a list showing locations where buried pipes below tracks are to be provided at the Bridge locations. Shall remove seals at appropriate time and use the buried pipes for cable crossing and reseal at ends after use.	Requirement if any will be approved by Engineer. Will provide pipes of required size, as per the designs of Contractor (CP-105) as approved by the Engineer and close them temporarily to avoid clogging/blockage.	Bridges & Viaduct

Item No.	Item Description	Systems Works Contractor (CP-105)	Civil, Building & Track Contractor (CST)	Locations
16.	Stations Building and Staff Quarter for Conduiting and Fan Boxes (concealed in concrete)	Shall provide drawings for conduits and fan boxes concealed in concrete. Shall coordinate with CST contractor and confirm suitability of locations and extend all assistance to facilitate laying of conduit and fan boxes as per requirement and approved drawings. Shall furnish the drawings for the openings in Slab and beams required if any.	Shall supply and install concealed conduits and fan boxes in concrete as per the approved drawings. Shall coordinate with the System Contractor (CP-105) and provide the openings in the slabs and the beams as required Shall provide fish wire in conduits and ensure conduits are free from any obstructions including protecting/ sealing them temporarily.	Station Building and Quarters
17.	Removal of Trees	- Shall list trees required to be removed from the different work sites of traction supply posts and coordinate with CST contractor for removal of trees in time	-Shall remove trees as per agreed time schedule, with the approval of Engineer	Main Line Traction Supply Posts—TSS, SSPs, ATS

18.4.2 Interface with System Contractors CP-104 & CP-305 of EDFC and CTP-14 of WDFC

1) Items of interface With OCC

Interfacing with the OCC Building Contractor will be required for

- a. Space requirement for SCADA system
- b. Work Station requirement
- c. Provision of Visual Display Units/ Rear Projection Screens/ display controllers etc.
- d. OCC Theater requirement for Traction SCADA
- e. UPS power and General Power supply requirement to be provided for SCADA system
- f. Cable route and support for SCADA cables,
- g. Earthing for SCADA equipment at OCC
- h. Provisions of OHE at boundary locations.

2) Information Exchange

The Contractor (CP-105) shall share the requirement to allocate the space and the system design

3) Interface requirements

The Interface requirements are described in **Table 18.4.2**.

Table – 18.4.2 (A)

Indicative Interface Matrix with Systems Contractor (CP-104) of EDFC.

Item No.	Item Description	Systems Works Contractor (CP-105)	System Contractor (CP-104) of EDFC	Remarks
1.	Space Requirement separately for Traction and Non-Traction SCADA equipment in OCC	Shall provide information, drawing & details for space require for Traction and Auxiliary SCADA equipment, space requirement for SCADA, space for Training Setup, AMS Setup and Operator Workstations as required for CP-105. Shall make close coordination, check and confirm suitability	Shall coordinate and interface to finalize the space requirement for Traction and Auxiliary SCADA Room, Training Setup, AMS Setup & Operator Workstations and make the provision for the same.	OCC
2.	Cable Route (for Traction and Non Traction SCADA)	Shall provide requirement of cable route and support for communication connectivity between various Traction and Auxiliary SCADA equipment and power distribution to SCADA equipment. Shall supply communication cables & power cables.	Shall allocate a dedicated cable route separately for Traction SCADA and Separately for Auxiliary SCADA. The contractor shall install support (metallic tray, conduit etc.) for communication connectivity between various SCADA equipment and power distribution to SCADA equipment as per the requirement of Contractor (CP-105).	OCC
3.	UPS supply for Traction and Auxiliary SCADA system	Shall share the details on SCADA Power supply requirement Shall extend UPS supply, including laying of power cables, and connections to as required	Shall coordinate with Contractor (CP-105) and arrange General Power Supply and UPS power supply for SCADA. Shall provide cable routes and cable supports	OCC
4.	Earthing	Shall coordinate for the provision of earth with Clean Earth station for use of SCADA. Shall connect SCADA's equipment with MET (clean earth) as per approved schematic.	Shall provide the clean earth system for use of SCADA system.	OCC
5.	Furniture at OCC	Shall issue layout plan of SCADA equipment and SCADA furniture and work stations etc. Shall issue details on requirement of cable	Shall provide space in theatre room as required by Contractor (CP-105)	OCC

Item No.	Item Description	Systems Works Contractor (CP-105)	System Contractor (CP-104) of EDFC	Remarks
		gallery; cable shaft/ Niche and false floor below equipment's if any. Shall provide the required Furniture as per Volume-3, Particular Specifications for E&M and associated work.		
6.	Lighting and power	Shall interface for any special requirement or preferred location of light fixture mounting and power socket.	Shall provide lighting system in coordination with Contractor (CP-105)	OCC
7.	Ventilation & Air-conditioning	Shall furnish equipment heat – load details, along with equipment layout	Shall review the heat load. Shall design Ventilation and Air-condition System for OCC theatre accommodating requirement of CP-105.	OCC
8.	Design and Erection of OHE and Earthing & Bonding arrangements at boundary locations on Khurja end – IR Kms 1367.00 (UP Line) & IR Kms 1367.900 (DN Line)	Shall design and prepare OHE Layout Plan in coordination with CP 104 including OHE overlaps upto the boundary location, Earthing & Bonding as per scope of work and as approved by the Engineer. Shall supply, install structures and lay OHE wires including Earthing & Bonding as approved by the Engineer.	Shall coordinate with CP 105 and share the design of OHE Layout for common section to finalize jointly. Shall coordinate CP 105 for structure selection and location for mast / structure in the common portion.	Boundary location between CPs- 104 & 105

sTable – 18.4.2 (B)

Indicative Interface with systems Contractor 305 for works at Khurja end;-

Item No.	Item Description	Systems Works Contractor (CP-105)	System Contractor (CP-305) of EDFC
1.	Design of OHE and Earthing & Bonding arrangements at boundary locations at Khurja (about IR Km : 1367.00)	<ul style="list-style-type: none"> • Shall design and prepare OHE Layout Plan in coordination with CP 305 including OHE overlaps upto the boundary location keeping in view the space requirements to accommodate the third middle line to come up in future (under the scope of CP 305) and shall get consent of the Engineer. • Shall coordinate with CP 305 contractor and decide the locations of portals and/or single line cantilever structures, as the case may be for the common run sub-section of the three lines – two of CP-105 section and the single line of CP-305 section. • If portals are required to be provided for the common section, CP 105 shall provide and install mast / structure as per design and as approved by the engineer. 	<ul style="list-style-type: none"> • Shall coordinate and share the design for the comment section to finalize. • Shall coordinate with CP 105 contractor for finalising the locations of portals and/or single line cantilever structures. • Shall coordinate CP 105 for structure selection and location for mast / structure in the common portion.
2.	Erection of OHE structure, Earthing & Bonding arrangements at boundary locations at Khurja(about IR Km : 1367.00)	<p>Shall co-ordinate with CP 305 for erection of OHE structures, stringing of AEW, provision of BEC, as required, including Earthing and boding etc</p> <p>Shall co-ordinated with CST contractors 302 & 303, as well as with CP-305 contractor.</p>	<p>Shall coordinate and provide information and OHE, Earthing & Bonding requirement to CP 105 to meet the requirement.</p> <p>Shall supply and erect single line OHE and connect it through Jumper/wire with the adjacent OHE under execution by CP 105, as per the design and as approved by the Engineer.</p>

Table - 18.4.2 (C)

Indicative Interface Matrix with CTP-14 contractor of WDFC

Sr No.	Item Description	System Contractor CP-105	WDFC contractor CTP-14
1.	OHE at boundary location IR KM 1412.660 of EDFC, corresponding chainage 142/111.680 of WDFC.	Shall design & prepare the OHE layout plan up to the boundary location of WDFC, keeping in view the OHE arrangement being provided by WDFC's CTP-14 contractor.	The positioning of OHE masts to string the OHE across the boundary point shall be decided in consultation with CP-105 contractor.
2.	Provision of Neutral Section.	Shall decide location of NSs on straight (tangent) lengths of both UP & DN lines in co-ordination with CTP-14 contractor and install NSs in position along with associated OHE.	Shall assist to CP 105 contractor and jointly decide location of Neutral Section. Shall assist CP 105 for installation of the NSs & associated OHE upto boundary location (Chainage : 1412.660), and as approved by the engineer.
3.	Earthing and Bonding arrangement at/across the boundary location.	Shall decide these plans in co-ordination with CTP-14 contractor	Shall jointly decide the earthing & bonding arrangements at the boundary location and arrange for interconnection..
4.	Laying Feeders from EDFC's NS to the WDFC's SP.	Shall coordinate with CTP 14 contractor for laying & connections of the Feeder wire to be provided by CTP 14 contractor.	Shall provide supporting structures and erect / lay and connect the feeder wire from SP (WDFC) to the location of NS of EDFC.
5.	SCADA Interface at the boundary SP.	a) Shall provide an RTU along with associated cable connection for SCADA linking to the bridging circuit breakers of the WDFC's SP at Dadri Jn. through which tele-signals will be obtained at the OCC	i) Shall facilitate provision of CP-105 SCADA interface at the SP. ii) The two SCADA systems will be interlocked at the SP as per the design arrangement to be provided by CTP-14 contractor.

		at Allahabad. b) Shall co-ordinate with CTP-14 contractor in preparation of Traction working rules for the SP circuit breakers operation.	iii) The control and operation of the SP's breakers will rest exclusively with WDFCC's OCC. iv) Traction working rules for switchgear operations at the SP will be prepared by WDFC contractor in consultation with CP-105 contractor.
--	--	--	---

18.4.3 Interface with Indian Railways

1) Items of interface With Railways

Interfacing with Indian Railways will be required for

- a. Power Supply Interface at Junction station and line connecting to IR,
- b. Data / Details Required for Simulation Studies,
- c. OHE layout including provision of Neutral section and OHE interface point between DFCC and IR
- d. Earthing of existing metallic structures of Railways in parallelism with DFCC Line

2) Information Exchange

The Systems Contractor (CP-105) shall share the system information and system design to establish compatibility with existing Indian Railway system

3) Interface requirements

The Interface requirements are described in **Table –18.4.3**.

Table – 18.4.3

Indicative Interface Matrix with Indian Railways

Item No.	Item Description	Systems Works Contractor (CP-105)	Indian Railways	Remarks
1	a) Traction Power Supply Interface at the Junction station with IR. b) Interface with IR Dadri yard lines up to KM location 1413.856	The conventional PTFE or short neutral sections shall be provided at inter-connecting lines / cross overs between DFCC and IR lines as per rules and regulations in ACTM.	OHE works pertaining to yard modification of IR will be carried out by IR. IR will allow access and grant necessary power blocks to integrate the DFC lines with the yard lines of IR.	Yards adjacent to station/ DFC Lines
2	OHE layout including provision of Neutral section and OHE meeting point between DFCC and IR	The OHE layout at the junction station covering OHE meeting point shall be coordinated with IR. This shall also require provision of jumpers at the overlaps and checking and adjusting levels at the alignment of OHE for smooth movement of LOCOMOTIVES.	IR shall scrutinize and approve the OHE layout for connecting chords at junction station. IR shall allow access and grant power block to the contractor (CP-105) at the time of execution, testing and commissioning. Cost of Power & Traffic Block if any shall be borne by DFCC. However, if any penalty becomes liveable on account of late cancellation of Block or otherwise due to any other reasons, shall be payable by the contractor.	Along the route at interface point
3	Data / Details Required for Simulation Studies	The system Contractor shall liaise with IR for seeking details of Rolling Stock/ LOCOS required for simulation for Traction and EMI/EMC studies	IR shall provide the details as required for the Simulation study.	
4	Electromagnetic Compatibility	Shall conduct EMC Study and share the study report details with IR. .	IR shall coordinate with the Systems Contractor (CP-105) to ensure compatibility.	Electromagnetic Compatibility
5	Earthing of existing metallic structures of	Shall ensure earthing of fencing and other metallic structure of Railways line (wired or unwired)	Shall provide list and drawings of fencing and other metallic structures running parallel to the	Junction Stations

Item No.	Item Description	Systems Works Contractor (CP-105)	Indian Railways	Remarks
	Railways in parallelism with DFCC Line.	adjacent and parallel with DFCC's 2X25 kV OHE by mean of two separate and distinct earth connections with BEC as required.	DFCC's track for long distances, Shall coordinate with DFCC's Contractor (CP-105) for suitable earthing connections	

18.4.4 Interface with Indian Railways and PGCIL for 132 KV POWER SUPPLY at the TSS

1) Items of interface With IR and PGCIL for 132kV Power

Interfacing with the IR and PGCIL will be required for

- a. Power Supply Interface at Traction Substation (TSS),
- b. 132 kV incoming gantry to allow IR to terminate three phase transmission line.
- c. Protection Coordination with IR/PGCIL
- d. Shall share Design data regarding short circuit level, harmonic suppression, and ascertain that these data is used for system design.
- e. Railways in parallelism with DFCC Line
- f. SCADA interface for LILO operation

2) Information Exchange

The Systems Contractor (CP-105) shall share the information related to protection coordination and system design to establish compatibility with Indian Railway's arrangement with Power Supply Authorities (DISCOM)

3) Interface requirements

The Interface requirements are described in **Table –18.4.4.**

Table – 18.4.4

Indicative Interfacing Matrix with Indian Railways-cum-PGCIL for Power Supply

Item No.	Item Description	Systems Works Contractor (CP-105)	Indian Railways / PGCIL	Remarks
1	Termination of 132 KV (LILO) feeders of IR & PGCIL at DFCC's Traction Sub-station.	Shall interface with Indian Railways & PGCIL and ascertain the provision of incoming gantry structure(s) for termination of LILO feeders. Shall provide 132 kV incoming gantry(s) to allow IR to terminate double circuit three phase feeder transmission lines, as per LILO arrangement of IR	Shall assist the DFCC and the System Contractor (CP-105) for requirement of LILO feeder termination at the TSS Gantry provided by CP 105.	TSS
2	Associated switch gear for LILO operation	Shall interface with IR & PGCIL and ascertain the provision of necessary bay equipment along with associated switchgear to be installed for satisfactory LILO operation.	Shall assist the DFCC and the System Contractor (CP-105) and share information regarding bay augmentation.	TSS
3	Design Data of Traction Installation	Shall design protection scheme and submit to IR / PGCIL for obtaining approval from IR / PGCIL . Shall ascertain the adequacy of the provisions as per the requirements of the IR (through PGCIL) and share Various design information viz. <ul style="list-style-type: none"> ▪ TSS Protection Scheme & Relay coordination ▪ Harmonic suppression, ▪ short circuit level 	Shall review and approve the final scheme of protection. Shall assist DFCC's Systems Contractor (CP-105) and share the relevant information required for protection.	TSS/GSS
4	Metering Equipment	Shall provide incoming metering bays with necessary check meters, metering CT, PT etc for measurement of voltage, current, p.f., kVA, kVARh, kWh, at TSS, in consultation with and as per IR / PGCIL specifications with required communication ports on 132 KV incoming side, in	Shall provide necessary tariff meters for measurement of voltage, current, p.f., kVA, kVARh, kWh, at TSS end.	TSS

Item No.	Item Description	Systems Works Contractor (CP-105)	Indian Railways / PGCIL	Remarks
		a separate cubicle at the TSS for transmitting the Energy and power quality data to OCC		
5	Earthing	Shall design earthing arrangement at the TSS in consultation with IR and PGCIL Shall make necessary arrangement for earthing.	Shall review and approve earthing arrangement.	TSS
6	Electromagnetic Compatibility	Shall conduct EMC Study and share the study report with IR.	IR shall review the EMC study and coordinate PGCIL & Contractor (CP-105) to ensure compliance of EMC.	TSS & Grid sub-stations supplying power to IR
7	Interface	Issues on interaction during design, construction and execution be resolved to the satisfaction of IR including Power Supply Utility / DISCOM supplying powers to IR transmission network. These issues may relate to metering, and on timing of completion, testing and commissioning.	Shall assist the DFCC and the Systems Contractor (CP-105) during design, construction and execution phases.	TSS & connecting GSSs of IR Transmission Line Network.
8	Design considerations with respect to feed from IR's Transmission line network via LILO arrangement	The Contractor's design simulation as required should be undertaken in consideration of the source of power supply from Indian Railways Transmission Line Network.	Shall share the information to the DFCC/CP 105, regarding the Power supply sources and Transmission line parameters as required for Design.	TSS, source of Supply
9	Control and Monitoring of LILO Network at IR End.	the contractor shall provide operation control workstation for LILO Network related with SCADA interface at IR end through secured Web server as required.	Shall assist the DFCC and the Systems Contractor (CP-105) for SCADA interface for LILO Network.	SCADA Control at IR end

(End of Chapter 18)

CHAPTER 19 –APPENDICES ON ABBREVIATIONS, SPECIFICATIONS

INDEX

Appendix No.	Description
1.	Definitions
2.	Abbreviations
3.	List of Indian Standards
4.	List of International Standards (EN/BS/IEC/IEEE/ISO/UL etc.)
5.	RDSO specifications
6.	RDSO Drawings
7.	CORE's Drawings
8.	Specifications of 60/84/100 MVA Scott connected Traction Transformer
9.	Specifications of 8-MVA Auto-Transformer (based on which the Specification for higher Capacity MVA Auto Transformer shall be drawn by the Contractor covering all aspects.)
10.	Joint Deed of Undertaking by the Qualified Equipment Manufacturer along with the Contractor and Indian Equipment Manufacturer/Indian Partner

Appendix-1

Definitions

Terminology	Explanation/definition
Acceptance Measurement	Final definitive records of the measurement of the installed contact wire heights and staggers at OCS support and at mid-spans.
Accessible voltage (Vacc)	The part of the rail potential under operating conditions that can be bridged by persons, the conductive path being conventionally from either hand to both feet through the body, or from hand to hand.
Aerial Earth Wire	A conductor on traction masts/structures/ supports and bonded to their metallic parts/ supports and connected to earth.
Auto Transformer	A transformer with a single winding that is Centre tapped to provide a zero potential traction return connection. The +25kV terminal is connected to the catenary and the -25kV terminal is connected to the autotransformer feeder or negative feeder.
Auto Transformer Station	A building or compound containing electrical switchgear, equipment and autotransformer(s) which are arranged to connect together a number of sections of overhead line equipment.
Auto-Tensioned Equipment	OCS conductors terminated with Auto Tensioning device with balance weights, springs or hydraulic tensioning devices to maintain constant tension.
Bonding	The electrical connection of two or more conductive parts to ensure a continuous path for electric current, or to maintain the connected parts at substantially the same potential.
British Standard	A standard published by the British Standards Institution. Its alphanumeric identity is prefixed by BS.
Common Bonding Network(CBN)	The CBN is the principle means for effecting bonding and earthing inside a building. It is the set of metallic components that are intentionally or incidentally interconnected to form the principal bonding network in a building. These components include: structural steel or reinforcing rods, metallic plumbing, AC power conduit, cable racks and bonding conductors.
Cross-Bond	In addition to longitudinal-bond on each track, the two tracks are bonded together via Traction Spider Plates.
Earth Electrode	A conductive part or a group of conductive parts in intimate contact with and providing an electrical connection to earth.
Earth Mat	A group of conductor rods connected together as a grid, with or without earthing electrodes normally connected at the grid points.
Earth Wire	A conductor electrically connecting together the steelwork of two or more overhead line structures or a number of overhead line small-part steelwork assemblies and bonded to a traction return rail or to the Centre tap of an impedance bond.
Earth	The conductive mass of the earth, whose electric potential at any point is conventionally taken as equal to zero.
Electrical Section	A length of overhead line equipment between switching stations or between a switching station and a terminal end.
Electrification System	Electric power distribution system along track which can be on side rails or overhead and distributes power from Feeder Stations to the train's current collection system.
Equipotential Bonding	Electrical connections ensuring that exposed conductive parts and extraneous conductive parts are maintained at substantially equal potential.

Terminology	Explanation/definition
European Standard	A standard published by the European Committee for Standardization or by the European Committee for Electro-technical Standardization. Its alphanumeric identity is prefixed by 'EN'.
Fault Current	The current that flows as a result of an unintentional electrical fault on the electrification system, such as a short circuit or flashover.
Feeding Section	A feeding section is defined as the section of overhead line between successive TSS/SP on either side of a feeder station.
First Emergency Feeding	The feeding arrangement when one of two feeder circuits to the feeder station has failed (in the case where the feeder station is fed by two feeder circuits). For feeder stations with one feeder circuit, the feeder circuit shall be used to T-feed the sections in both directions. In the latter case, normal and first emergency feeding arrangements are the same.
International Standard	A standard published by the International Electro-technical Commission. Its alphanumeric identity is prefixed by 'IEC'.
Load Current	The current that flows as a result of the operation of electric trains.
Metallic Service	A service having an exposed metallic surface, such as a gas or water pipe, a conduit, or a metal-sheathed cable.
Normal Feeding	The feeding arrangement when both 220/132kv feeder circuits to the Traction Sub-station are healthy and available for service. All feeder circuits shall be used to radial feed their respective sections with a neutral section between them.
Overhead Contact line Zone	The zone whose limits are not exceeded, in general, by a live, broken overhead line conductor. The term applies to out-of-running overhead line conductors but not to those conductors that are not mechanically strained by pantographs, because the probability of breakage is too small. The profile and dimensions of the zone are defined in BS EN 50122-1. See also pantograph zone.
Pantograph Zone	The zone whose limits are not exceeded, in general, by a live, broken or de-wired pantograph. Its profile and dimensions are defined in BS EN 50122-1. See also overhead contact line zone.
Rail Potential	The voltage occurring between the traction return rails and earth under operating conditions and or under fault conditions.
Return Conductor	A conductor connected in series with the secondary windings of booster transformers, and bonded to the traction return rails to carry traction return current back to a feeder station independently of the running rails. However here it will be referred interchangeably as Negative feeder or Return conductor or Return feeder.
Second Emergency feeding	The feeding arrangement when both the feeder circuits to the feeder station have failed (in the case where the Feeding Station is fed by two feeders circuits), or when the single feeder to the feeding station has failed (in the case where the Feeding Station is fed by a single feeder circuit). The affected sections are fed by the adjacent feeder stations.
Simultaneous Touching Distance	The distance which can be bridged by a person. In general a minimum horizontal dimension of 2m and a minimum vertical dimension of 2.5m are adopted.
Stray Current	Electric current that follows paths other than intended paths. Stray currents occur in A.C. traction systems but only d.c. stray current is corrosive to steel structures.
Touch Potential,	The electrical potential difference between two parts at different electrical

Terminology	Explanation/definition
Touch Voltage(V _{touch})	potentials under fault conditions that is experienced when touched.
Traction Power Supply System	The Traction Power supply System is defined as the Infrastructure between the point of common coupling with State Power DISCOM and the pantograph of the Locomotive and Rail.
Project Wide	Project Wide is defined as Eastern Dedicated Freight Corridor Project Phase-I Dadri – Khurja section and includes all contractors working on the section like CST (Civil and Track work – contractor)
Proven	The proposed system / equipment to be used should be of proven performance and record of at least two years. The same should have been in use in adequate numbers (at least two unless specifically asked more) in Metro / Railway system or Power Utilities

Appendix-2

Abbreviations

AC	Alternating Current
ACO	Automatic change over switch
ACS	Access Control (Rail System)
ACTM	Alternating Current Traction Manual
AT	Auto Transformer
ATS	Auto Transformer Stations
ATD	Auto Tensioning Device
Aux	Auxiliary
BIS	Bureau of Indian Standards
BWA	Balance Weight Assembly
CB	Circuit Breaker
CEA	Central Electricity Authority – Government of India
CORE	Central Organization for Railway Electrification
CBT	Computer Based Training
DFC	Dedicated Freight Corridor
DFCCIL	Dedicated Freight Corridor Corporation India Limited
DSC	Double Stack Container
DLP	Defect Liability Period
EPDM	Ethylene Propylene Diene Monomer
EMC	Electromagnetic Compatibility
EMI	Electromagnetic Interference
FMECA	Failure modes, effects and criticality analysis
FOB	Foot Over Bridge
GS	General Specifications
GSS	Grid Substation
HF	Human Factors
HFIP	Human Factors Integration Plan
HV	High Voltage
I/O	Input/ output
IR	Indian Railway
IEC	International Electro-technical Commission
IEEE	Institute of Electrical and Electronic Engineers Inc.
IPR	Intellectual Property Rights
IS	Indian Standards
LILO	Loop In Loop Out
LV	Low Voltage

MMD	Maximum Moving Dimension
MPCC	Main Power Control Centre
MOU	Memorandum of Understanding
OCS	Overhead Contact System
OFC	Optical Fibre Cable
OHE	Overhead Equipment
ONAN	Oil Natural Air Natural
ONAF	Oil Natural Air Forced
PCB	Poly Chlorinated Biphenyls
PDF	Portable Document Format
PGCIL	Power Grid Corporation of India Limited
PHA	Polycyclic Aromatic Hydrocarbons
PLC	Programmable Logic Controllers
PS	Particular Specifications
RAM	Reliability, availability and maintainability
RAMS	Reliability, availability, maintainability and safety
RBD	Reliability Block Diagram
RDSO	Research Design and Standard Organization under the Ministry of Railways
RTU	Remote Terminal Unit
ROW	Right of Way
SCADA	Supervisory Control and Data Acquisition
SQE	Safety, Quality and Environment
SSP	Sub-Sectioning and Paralleling Post
SP	Sectioning and Paralleling Post
SCP	Supply Control Post
SPS	Small Part Steelwork
SSOD	Standard Schedule of Dimensions
SAT	Site Acceptance Test
TBA	To be advised
TSS	Traction Substation
TOT	Transfer of Technology
XLPE	Cross Linked Polyethylene

Appendix-3

List of Indian Standards (IS)

Sr.	Number of IS	Description
1.	226-1975 814-1974 816-1969 823-1964 6227-1971	Structural steel (standard quality) Specification for mild steel and tinplate drums Code of practice for use of metal arc welding for general construction in mild steel Code Of Procedure For Manual Metal Arc Welding Of Mild Steel Code Of Practice For Use Of Metal Arc Welding In Tubular Structure
2.	269-1989 (4th rev.)	Specifications for 33 grade ordinary Portland cement.
3.	335-1993	New Insulating Oils.
4.	383-1970 & 515-1959	Fine & coarse aggregates for concrete.
5.	432-1982	Specifications for mild steel and medium tensile steel bars and hard drawn steel wires for concrete reinforcement.
6.	694-1990	PVC Insulated cables for working voltages up to and including 1100 Volts.
7.	1248-2003	Direct Acting Electrical Indicating Instruments.
8.	1554-1988	PVC Insulated (Heavy Duty) Electric Cables
9.	1753-1967	Aluminum conductors for insulated cables.
10.	2099-1986	Bushing for Alternating Voltages Above 1000V (2nd Revision).
11.	2705-1992	Current Transformers.
12.	2834-1986	Shunt Capacitors for Power Systems
13.	3043-1987	Code of Practice for Earthing.
14.	3156-1992/4146-1983	Voltage Transformers/Application guide for Voltage Transformers.
15.	3231	Electrical Relays for Power System Protection.
16.	3401-1992	Specifications for Silica Gel.
17.	3427-1997	Metal Enclosed Switchgear & Control Gear for Voltages Above 1000V up to and Including 52000V.
18.	3639-1966	Fittings and accessories for power transformers.
19.	3842	Application guide for electrical relays for ac systems
20.	3961-1968 (Part III)	Recommended current ratings for cables.
21.	5138-1978	Enclosure construction with single sheet sturdy frame construction.
22.	5216	Recommendations on Safety Procedures and Practices in Electrical Work.
23.	5891-1970	Recommended Short Circuit Rating of High Voltage XLPE Insulated PVC Cables.
24.	6600-1972 /	Guide for Loading of Oil Immersed Transformers.
25.	10561-1983/	Application Guide for Power Transformers.
26.	10593-2006	Mineral Oil-impregnated electrical equipment in services - Guide to the interpretation of dissolved and free gases analysis.

Appendix-4

List of International Standards (DIN/EN/BS/IEC/IEEE/ISO/UL etc.)

S. No	Standard Number	Description
1.	BS 5308	Instrumentation cables – Part 1 Specifications for polyethylene cables
2.	BS 7671	Requirements for Electrical Installations.
3.	BS 7835	Specifications for cables with cross-linked polyethylene or ethylene propylene rubber Insulation for rated voltages from 3800/6600 V up to 19000/33000 V having low emission of smoke and corrosive gases when affected by fire.
4.	BS EN 50082-1	Electromagnetic compatibility - Generic immunity standard Part 1: Residential, commercial and light industry.
5.	DD ENV 50121 (All parts)	Railway applications - Electromagnetic compatibility.
6.	DIN 43668	Key for the doors of electrical switchgear cubicles and cabinets; double-bit key.
7.	DIN 43671	Copper bus bars; design for continuous current.
8.	DIN 43761	Temperature Sensors.
9.	DIN 53504	Tensile strength.
10.	DIN 53577	Compressive strength.
11.	DIN EN 13601	Copper rod, bar and wire for general electrical purposes.
12.	EN ISO 9001	Quality systems: Model for quality assurance in design, development, production, installation and servicing.
13.	EN 50119	Railway Applications - Fixed installations- Electric traction overhead lines.
14.	EN 50121	Railway applications - Electromagnetic compatibility.
15.	EN 50122	Railway Application - Fixed Installations, Electrical Safety, Earthing and return circuit.
16.	EN 50124-1	Insulation Co-ordination in Traction Systems.
17.	EN 50125-2	Environmental Conditions for Fixed Installations.
18.	EN 50126	Railway applications: The specifications and demonstration of dependability, reliability, availability, maintainability and safety (RAMS).
19.	EN 50149	Railway applications. Fixed installations. Electric traction. Copper and copper alloy grooved contact wires.
20.	EN 50152	Railway Applications- Fixed Installations - Particular requirements for AC Switchgear. (All parts).
21.	EN 50522	Earthing of Power System exceeding 1 kV/ac
22.	EN 50163	Railway Application - Supply Voltages of traction systems.
23.	EN 50272 (Part 2)	Safety requirements for secondary batteries and battery installations - Stationary batteries
24.	EN 50329	Railway applications. Fixed installations. Traction transformers.
25.	EN 60051	Direct acting indicating analogue electrical measuring instruments and their accessories.
26.	EN 60076	Power Transformers / Reactors
27.	EN 60137	Insulated Bushings for Alternating Voltages above 1kV.
28.	EN 60417	Graphical symbols for use on equipment.
29.	EN 60507	Artificial pollution tests on high-voltage insulators to be used on ac systems.

S. No	Standard Number	Description
30.	EN 60529	Specifications for the degree of protection provided by enclosures (IP code).
31.	EN 60721	Classification of environmental conditions. Environmental parameters and their severities.
32.	EN 60896-2	Stationary lead-acid batteries. General requirements and methods of test. Valve regulated types.
33.	EN 61140	Protection against shock – Common aspects for installation and equipment.
34.	EN 61230	Live Working – Portable Equipment for Earthing or Earthing and short circuiting.
35.	EN 61325	Insulators for Overhead Lines with Nominal Voltages above 1000 V.
36.	EN 61508	Functional safety of electrical/ electronic/ programmable electronic safety related systems.
37.	EN 61952	Insulators for overhead lines. Composite line post insulators for alternating current with a nominal voltage.
38.	EN 62271	High-voltage switchgear and control gear.
39.	IEC Hand Book for Temperature Index	Cable in fire regarding temperature Index Chapter-6.
40.	IEC 60068	Environmental Testing
41.	IEC 60137	Bushings for alternating voltages above 1000 Volts.
42.	IEC 61508	Functional Safety – Programmable Safety related systems.
43.	IEC 60044	Instrument transformers – current transformers.
44.	IEC 60076	Power Transformers.
45.	IEC 60255	Measuring Relays and Protection Equipment.
46.	IEC 60376	Specifications of technical grade Sulphur Hexafluoride (SF6) for use in electrical equipment.
47.	IEC 60502	Power Cables - Extruded Insulation for rated voltages from 1 kV up to 30 kV.
48.	IEC 60616	Terminal and tapping markings for power transformers.
49.	IEC 60850	Railway applications – Supply voltages of traction systems.
50.	IEC 61000	Electromagnetic compatibility.
51.	IEC 61243	Line working - Voltage Detector.
52.	IEC 62128	Railway applications - Fixed installations - Electrical safety, earthing and return circuit. Part 1:
53.	IEC 62236	Railway Applications – Electromagnetic Compatibility.
54.	IEC 62271	High Voltage Switchgear and Control Gear above 53 kV.

S. No	Standard Number	Description
1.	IEEE80:2013	Guide for safety in ac substation grounding.
2.	IEEE 81	Guide for Measuring Earth Resistivity, Ground Impedance, and Earth Surface Potential of a Grid System.
3.	IEEE 485	IEEE Recommended Practice for Sizing of Large Lead Storage Batteries for generating Station and Substations.
4.	IEEE 738	Standard for Calculating Current-Temperature of Bare Overhead Conductors.
5.	IEEE 980	Guide for Containment and Control of Oil Spills in Substations.
6.	IEEE 1187	Recommended Practice for Installation Design and Installation of Valve-regulated Lead acid Storage batteries for Stationary Applications.
7.	IEEE 1188	IEEE Recommended Practice for Maintenance, Testing and Replacement of valve-regulated Lead Acid (VRLA) Batteries for Stationary Applications.
8.	IEEE 1189	IEEE Guide for Selection of Valve-regulated Lead Acid (VRLA) Batteries for Stationary Applications.
9.	IEEE 1313.1	Standard for Insulation Coordination
10.	IEEE C2	National Electrical Safety Code.
11.	IEEE C37.30	Standard requirements for High-Voltage Switches.
12.	IEEE C37.32	HV switches, Bus Supports and Accessories, Schedule of Preferred Ratings, Construction Guidelines and Specifications.
13.	IEEE C37.37	Standard Loading Guide for AC HV Air switches (in excess of 1000V).
14.	IEEE C57.93	Guide for Installation of Liquid Immersed Power transformers.
15.	IEEE C95.1	Safety Levels with respect to Human Exposure to Radio Frequency Electromagnetic Fields, 3 kHz to 300 GHz.
16.	IEEE C95.6	Standard for Safety Level with respect to Human Exposure to Electromagnetic Fields 0-3 kHz.
17.	IEEE 525	Guide for installation of cable systems in substations
18.	IEEE 979	Guide for substation Fire protection
19.	IEEE 998	Guide for direct Lightning stroke shielding of substations
20.	ISO 3864	Graphical symbols -- Safety colours and safety signs.
21.	ISO 17398	Safety colours and safety signs.
22.	NEC 300-21	Spread of Fire or Products of Combustion.
23.	NEMA 250	Enclosures for Electrical Equipment.
24.	NEMA AB1	Moulded Case Circuit Breakers and Moulded Case Switches.
25.	NEMA BU1	Bus ways.
26.	NEMA SG5	Power Switchgear Assemblies.
27.	NEMA SG6	Power Switching Equipment.
28.	NEMA TR208	Disconnect Switchgear Insulators.
29.	NFPA 70	National Electrical Code.

Appendix-5

List of RDSO Specifications

S. No	Specifications No.	Description
1	ETI/OHE/3	Technical specifications for Annealed stranded copper conductors for jumper wire for Electric Traction.
2	ETI/OHE/11	Specifications for steel tubes.
3	ETI/OHE/13	Specifications for Hot dip zinc galvanization of steel masts (Rolled & Fabricated), tubes and fittings used on 25kV ac OHE.
4	ETI/OHE/16	Specifications for 25kV ac single pole and double pole isolators for Railway Electrification.
5	ETI/OHE/18	Specifications for Steel and stainless steel bolts, nuts and washers.
6	ETI/OHE/21	Aluminum alloy section and tubes for 25kV Traction Overhead Equipment.
7	ETI/OHE/27	Section Insulator assembly without sectioning insulator.
8	ETI/OHE/33	Specifications for Enameled steel plates.
9	ETI/OHE/33A	Provisional specifications for "retro-reflective structure Number plates."
10	ETI/OHE/36	Specifications for Galvanized steel wire rope.
11	ETI/OHE/42	Technical specifications for hard drawn grooved contact wire for electric traction (jointed/welded contact wire).
12	ETI/OHE/48	Technical specifications for Winch type regulating equipment for 25kV ac traction.
13	ETI/OHE/49	Technical specifications for Fittings for 25 kV ac OHE.
14	ETI/OHE/50	Technical Specifications for cadmium copper conductors for overhead Railway traction.
15	ETI/OHE/51	Specifications for Discharge/earthing pole assembly for 25kV ac traction.
16	ETI/OHE/52	Specifications for Interlocks for ac traction switchgears.
17	ETI/OHE/53	Principles for OHE layout plans and sectioning diagrams for 25kV ac traction.
18	ETI/OHE/54	Specifications for 19/2.79mm all aluminum alloy stranded catenary wire.
19	ETI/OHE/55	Specifications for Bimetallic (aluminum-copper) strip.
20	ETI/OHE/58/1	Specifications for hand operated lifting and swiveling platform.
21	ETI/OHE/64	Specifications for solid core cylindrical post insulators for systems with nominal voltages of 220kV, 132kV, 110kV & 66kV.
22	ETI/OHE/65	Specifications for continuous cast copper wire rods.
23	ETI/OHE/71	Code of bonding and earthing for 25kV ac 50Hz single phase traction system.
24	ETI/OHE/76	Technical Specifications for hard drawn grooved contact wire for electric traction drawn out of continuous cast copper (ccc) wire rods.

S. No	Specifications No.	Description
25	ETI/PSI/1	Battery charger for 110 volt battery, 40 Ah.
26	ETI/PSI/14	Technical specifications for 25kV drop out fuse switch and operating pole for use with 110kVA and 100kVA, 25k/240V LT supply transformers.
27	ETI/PSI/15	Specifications for 25kV/240V, 5 kVA, 10kVA, 25kVA & 50kVA, 50 Hz, single phase, oil filled auxiliary transformers for Railway AC traction system.
28	ETI/PSI/15A	25kV/240V L.T. supply Transformer, 100kVA.
29	ETI/PSI/24	Battery charger for 110V Battery, 200 AH.
30	ETI/PSI/29	Low tension Distribution panels for Railway A.C traction sub-stations.
31	ETI/PSI/31	Standard for Drawings for power supply Installations.
32	ETI/PSI/63	Low tension distribution panels.
33	ETI/PSI/71	Metal oxide gapless type lightning arrester for use on 25 kV side of Railway traction substations and switching stations.
34	ETI/PSI/90	25 kV ac 50 Hz single phase oil filled current transformers with ratio of (i) 1000-500/5A, (for general purposes), (ii) 1500-750/5 (for heavy duty).
35	ETI/PSI/117	Technical specifications for current transformers: I. 220kV. 200-100/5A, II. 132kV. 400-200/5A, III. 110kV.400-200/5A, IV. 66kV.800-400/5A for Railway A.C traction substations.
36	ETI/PSI/120	Code of practice for earthing of power supply installations for 25kV ac, 50 Hz, single phase traction system.
37	ETI/PSI/122	Technical Specifications for 245 kV, 145 kV, 123 kV, 72.5 kV, Double Pole & Triple Pole Isolator for Railway Traction Sub-Stations.
38	ETI/PSI/123	8MVA, 54kV 50Hz, Auto Transformer for Railway 2 x 25kV AT Feeding System.
39	ETI/PSI/124	54 MVA, 220/2 x 27kV Scott connected Traction Power Transformer for 27 kV AT feeder system for Railway ac Traction Sub-station.
40	ETI/PSI/132	25 kV double pole outdoor, vacuum interrupters for Railway switching stations for 2x25 kV 'AT' feeding system.
41	ETI/PSI/133	25kV ac Double Pole Isolators for 2 x 25kV AT feeding system.
42	ETI/PSI/137	Metal oxide gapless type lightning arresters for use of 220/132/110/66 kV side of railway ac traction substation.
43	ETI/PSI/167	25kV AC 50Hz single pole, outdoor interrupter for Railway traction switching stations.
44	RE/30/OHE/5	Specifications for Copper bus bar.
45	RE/OHE/25	Standard for Drawings for Traction Overhead equipment.
46	RDSO/PE/SPEC/AC/0100,(Rev.'1') - 2011	Technical Specifications for Double capped tubular T5 Fluorescent lamps, T5 luminaire & Electronic ballast.
47	RDSO/PE/SPEC/TL/	Specifications for low maintenance lead acid batteries for 40 Amp

S. No	Specifications No.	Description
	0040-2003 (Rev-0)	hour and 200 Amp hour cells for traction distribution system.
48	TI/SPC/LWTSI/0060	Specifications for light weight section insulator assembly.
49	TI/SPC/OHE/ATD/0060	Specifications for Three pulley type regulating equipment (3:1 Ratio).
50	TI/SPC/OHE/FRPNP/INS/COM/1070	Technical specifications for silicon composite insulators for 25kV ac 50Hz single phase overhead traction lines.
51	TI/SPC/OHE/GALST B/0040	Technical specifications for galvanized steel stranded wire for traction bonds for 25kV ac Electric traction systems.
52	TI/SPC/OHE/GATD/0080	Technical specifications for gas auto tensioning device.
53	TI/SPC/OHE/GSSW/0090	Schedule of technical requirements for manufacture of Galvanized steel stranded wire (GSSW).
54	TI/SPC/OHE/HDCSC F/0030	Technical specifications for 37/2.25mm Hard Drawn Stranded copper conductor.
55	TI/SPC/OHE/INS/0070	Specifications of solid core porcelain insulators for 25kV A.C 50 Hz single phase overhead traction lines.
56	TI/SPC/OHE/INS/0700	Specifications for stainless steel wire rope.
57	TI/SPC/OHE/INSCAT /0000	Insulated Cadmium Copper Catenary 19/2.1mm. Diameter for provision under overhead line structures in the 25kV ac Electric Traction.
58	TI/SPC/OHE/INSTES T/0090	Specifications for Testing load testing machine 25kV Porcelain & Composite insulator before installation.
59	TI/SPC/OHE/POST/0100	Specifications for solid core porcelain cylindrical post insulator for systems with nominal voltage of 66kV, 110kV, 132kV & 220kV.
60	TI/SPC/OHE/SNS/0000	Specifications for short Neutral section assembly (Phase Break).
61	TI/SPC/OHE/WR/1060	Specifications for solid porcelain insulators for 25kV ac 50hz single phase overhead traction lines.
62	TI/SPC/PSI/CB/0000	Outdoor Circuit Breaker for Railway ac Traction Sub-stations.
63	TI/SPC/PSI/FC&SR/0100	Technical specifications for shunt capacitor & series reactor equipment for traction sub-station.
64	TI/SPC/PSI/ISOLTR/1060	25kVac Single Pole and Double Pole Motorized Isolators for Railway Traction.
65	TI/SPC/PSI/MOGTLA /0100	42 KV Metal oxide gapless type lightning arrester for use on 25 KV side & Railway Traction substation and Switching Station.
66	TI/SPC/PSI/PROTCT /1982	Specifications for Delta-I type High Resistive fault selective relay for 25 kV ac traction systems.
67	TI/SPC/PSI/PROTCT /2983	Specifications for Panto Flashover Protection relay for 25 kV ac traction System.
68	TI/SPC/PSI/PROTCT /6070	Control and relay panel for 25kV ac TSS including specifications for numerical type protection relays for traction transformer, 25kV shunt

S. No	Specifications No.	Description
		capacitor bank and transmission line for 25kV AC TSS on Indian Railways.
69	TI/SPC/PSI/PROTEC T/7100	Technical specifications for control and relay panel including numerical type protection relays for Scott-connected/single phase traction transformers, OHE protection and shunt capacitor bank protection for 2x25 kV traction sub-station.
70	TI/SPC/PSI/PTs/0990	Technical specifications for 220kV or 132kV or 110kV or 66kV or 25kV potential transformer.
71	TI/SPC/PSI/VACINT/0040	Magnetic actuator type 25 kV ac, 50 Hz, single pole, outdoor vacuum interrupter for railway traction switching Station.

Appendix-6

List of RDSO Drawings

Sl. No	Brief Description	Drawing		Mod. No.
		Series	Number	
1	Typical location & schematic connection diagram for a three interrupter switching station.	ETI/PSI	003	C
2	Typical general arrangement of a three interrupter switching station.	ETI/PSI	004	F
3	Typical location plan & general arrangement for sectioning & paralleling station.	ETI/PSI	005	F
4	Typical location plan and general arrangement for a feeding station.	ETI/PSI	006	E
5	Details of foundation for fencing upright.	ETI/C	0032	B
6	Details for pre-cast cable trench for switching station.	ETI/C	0038	E
7	Remote Control Cubical at station, Foundation, RCC Slab, building plant and steel door.	ETI/C	0067	B
8	Protective screen of foot-over bridge and road over-bridge.	ETI/C	0068	G
9	Typical fencing and anti-climbing arrangement at switching stations.	ETI/PSI	104	E
10	Typical fencing layout at TSS (Details of Fencing panel, door, anti-climbing device etc.).	ETI/PS2	121	F
11	General arrangement & details of fencing panels & gate for switching stations.	ETI/C	0186 Sh.I& II	E
12	Typical earthing layout of sub- sectioning and paralleling station.	ETI/PSI	201	B
13	Typical Cable trench layout and foundation layout of 132/ 25kV TSS.	ETI/C	0210	F
14	Details of baffle wall at TSS (WP-112.5 Kg f/m ² and WP-75 kg f/m ²).	E TI/C	0213	D
15	Details of RCC baffle wall at TSS (WP-150kgf/m ²).	ETI/C	0214	B
16	Transformer oil drainage arrangement at substations.	ETI/C	0216	B
17	Arrangement for false catenary under over line structure.	ETI/OHE/SK	446	--
18	Special arrangement of OHE under over line structure.	ETI/OHE/SK	529	--
19	Arrangement of overlap.	ETI/OHE/SK	566	-
20	Typical arrangement of OHE with insulated copper catenary under over line structure.	ETI/OHE/SK	570	--
21	Schematic arrangement of un-insulated over Lap (type-I) (3 & 4 Span overlaps).	RE/33/G	02121 Sh.1	F
22	Schematic arrangement of un-insulated overlaps (3 &	ETI/OHE/G	02121 Sh.4	A

Sl. No	Brief Description	Drawing		Mod. No.
		Series	Number	
	4 span overlaps).			
23	Schematic arrangement of insulated overlap.	ETI/OHE/G	02123 Sh.3	A
24	Schematic arrangement of insulated overlap.	ETI/OHE/G	02131 Sh.1	
25	General arrangement of regulated OHE at turn-outs (overlaps & crossed type).	ETI/OHE/G	02141	C
26	General arrangement of regulated OHE at cross over (overlap & crossed type).	ETI/OHE/G	02151	-
27	Arrangement of neutral section.	ETI/OHE/G	02161 Sh.1	C
28	Arrangement of short neutral section.	ETI/OHE/G	02161Sh.2	-
29	Arrangement of neutral section assembly (PTFE Type) at SWS.	ETI/OHE/G	02162	-
30	Standard termination of OHE (Regulated & un-regulated).	ETI/OHE/G	03121 (All parts).	E
31	General arrangement of connections to OHE by copper cross feeder (150).	ETI/OHE/G	05121 Sh.1	C
32	General arrangement of connections at switching station on double track section by copper cross feeder.	ETI/OHE/G	05122 Sh.1	C
33	General arrangement of connections at switching station on multiple track section by copper cross feeder.	ETI/OHE/G	05123 Sh.1	C
34	Arrangement of suspension of double spider 25 kV feeder and return feeder between sub-station and feeding station.	RE/33/G	05152	C
35	General arrangement of earth wire on OHE mast.	ETI/OHE/G	05201	A
36	Arrangement of transverse bonds.	ETI/OHE/G	05251	A
37	Suspension of 25kV feeder on OHE mast	ETI/OHE/G	05143	B

Appendix-7

List of CORE Drawings

(The listed Drawings of CORE are indicative and demonstrate the level of information and general description. The Equipment Support Structure and Foundations shall be designed as per the application duty requirement and the thermo dynamic stresses as may be witnessed by the equipment while operations or the Short Circuit Faults. The Manufacturer recommended Drawing will prevail subject to the local application duty, environment condition, soil bearing capacity and Insulation Coordination.)

Sl. No.	TITLE OF DRAWINGS	DRAWING NO.
1	Structural layout of 132/25 kV traction sub-stations.	ETI/C/0200, SH.No.-1 (Mod-H); SH.No.-2 (Mod-D)
2	Typical cable trench and foundation lay out of 132/25kv TSS.	ETI/C/0210 (Mod. F)
3	Line Diagram of Structural layouts of 220/25kV Traction sub-station.	ETI/C/0222
4	Structural layout of 220/27kV traction sub-station (Type-I).	ETI/C/0222-I
5	Characteristics of conductors/ bus bar for 25kV AC traction.	ETI/OHE/G/05600 (Mod. A)
6	Typical earthing, cable trench & foundation layout of 132/25kv TSS.	ETI/PSI/ 224 (Mod. E)
7	Typical layout of Remote Control cubicle at a switching station.	ETI/PSI/0010 (Mod. E)
8	Typical location plan and general arrangement for a feeding station.	ETI/PSI/006 (Mod. E)
9	Typical return current connection to buried rail at 132/25kv Traction sub-station.	ETI/PSI/0212-1 (Mod. NIL)
10	Typical layout for 25kv Shunt capacitor with series reactor to be installed at 132/25kv TSS.	ETI/PSI/0223 (Mod. E)
11	Typical general arrangement of earth screen wire termination at Traction substation.	ETI/PSI/0225 (Mod. C)
12	Typical schematic diagram of protection for single transformer traction sub-station.	ETI/PSI/0228-1 (Mod-NIL)
13	High speed auto reclosing scheme for feeder circuit breaker at 25kV A.C TSS.	ETI/PSI/0231-I (Mod A)
14	Typical layout of 220/27kV traction substation (Type-I).	ETI/PSI/0230-1 (Mod. NIL)
15	Typical schematic diagram of protection for double Transformer traction substation.	ETI/PSI/024-1 (Mod. NIL)
16	Typical return current connection to buried rail at 220/25kV Traction sub-station.	ETI/PSI/0242 (Mod. A)
17	Typical general arrangement of earth screen wire termination at 220/25kV traction sub-station.	ETI/PSI/0244

Sl. No.	TITLE OF DRAWINGS	DRAWING NO.
18	Typical earthing layout of a feeding station	ETI/PSI/203 (Mod. B)
19	Typical earthing arrangement for equipment/ structure at TSS.	ETI/PSI/228 (Mod-A)
20	Schematic inter connection diagram for remote control of power gear & supervision equipment at TSS.	ETI/PSI/644 (Mod. C)
21	Schematic inter connection diagram for remote control of power gear and supervision equipment at controlled station (SP & SSP).	ETI/PSI/645 (Mod. C)
22	General scheme of supply for 25 kV 50 Hz single phase AC traction system.	ETI/PSI/702-1 (Mod. D& E) &
23	Control desk arrangement for 2 work stations of SCADA system.	ETI/PSI/SK/337
24	Arrangement of suspension of double spider 25kV feeder and return feeder between substation and feeding station	RE/33/G/05152 (Mod. C)
25	Standard plan of control room at traction sub-station (General arrangement and RCC details)	RE/Civil/S-144/06
26	Typical schematic diagram for TSS, FP, SSP and SP with 21.6 MVA or 30 MVA transformers for three lines.	TI/DRG/PSI/3L-TSS/RDSO/00001/ 07/1 (Mod-NIL)
27	Typical layout of Control Room at traction sub-station.	TI/DRG/PSI/CROOM/RDSO/00001/01/0
28	Typical layout of 132 /27kV Traction sub-station.	TI/DRG/PSI/TSSLO/RDSO/00001/01/0

Appendix-8

SPECIFICATION FOR 60/84/100 MVA, 220/132 kV/54 kV SCOTT-CONNECTED TRACTION POWER TRANSFORMER FOR 2x25 kV AT FEEDING SYSTEM

1 SCOPE

- 1.1 This document applies to 60/84/100 MVA, ONAN/ONAF/OFAF, 220/132/54kV Scott-connected traction power transformers for Auto Transformer (AT) feeding system for installation in DFCC.
- 1.2 The transformer shall be complete with all parts, fittings and accessories whether specifically mentioned herein or not, necessary for its efficient operation in an unattended traction substation and it shall be supplied with appropriate firefighting system as per IS-3034:1993 or with Nitrogen Injection Fire protection system as per safety guidelines 2010 issued by CEA.

2 GOVERNING SPECIFICATION

- 2.1 In the preparation of this document, assistance has been taken from the following National and International standards, wherever applicable.

Table No. 2.1.1

Standard		Description
Equivalents	IS	
IEC 60076 (all parts)	IS:2026 (all parts)	Power transformers.
IEC 60044-1	IS:2705	Instrument transformer – Part 1: Current transformer.
IEC 60137	IS:2099	Bushing for alternating voltages above 1000V
IEC 60214	IS:8468	Tap changers.
IEC 60296	IS:335	Fluids for electro technical applications - Unused mineral insulating oils for transformers and switchgear/ New insulating oils.
	IS:5	Colours for ready mix paints and Enamels.
IEC 60502-1	IS:1554 (Part 1)	PVC insulated (heavy duty) Electric cables: Part 1 For working voltages up to and including 1100V
	IS:1570	Schedules for Wrought Steels - Part 5: Stainless and heat resisting steels.
	IS:1576	Solid pressboard for electrical purposes
IEC 60422	IS:1866	Code of practice for electrical maintenance and supervision of mineral insulating oil in equipment
	IS:2927	Brazing alloy
JIS C 2553	IS:3024	Grain oriented electrical steel sheets and strips

	IS: 3637	Gas operated relays
	IS:3639	Fittings and accessories for power transformers
	IS:4253	Cork composition sheets : Part 2 Cork and Rubber
	IS:5561	Electrical power connectors
IEC 60909	IS:13234	Guide for short circuit calculations in 3-Phase ac systems.
IEC 60270	IS: 6209	High-voltage test techniques - Partial discharge measurements.
	IS:6600	Guide for loading of oil-immersed transformers
	IS:10028 (all parts)	Code of practice for selection, installation and maintenance of transformers
	IS:10593	Mineral Oil-impregnated electrical equipment in services - Guide to the interpretation of dissolved and free gases analysis
IEC 60137	IS: 12676	Oil impregnated paper insulated condensers bushings – dimensions and requirements
	DIN 7733	Laminated products, pressboard for electrical engineering, types.
		Central Electricity Authority (Measures relating to Safety and Electricity Supply) Regulations, 2010, part-III, Sec.4, 2010 Rule no. 44 (2) (ix).

2.2 In case of any conflict between the contents of the above standards and this document, the later shall prevail.

3 CLIMATIC AND ATMOSPHERIC CONDITIONS

3.1 The transformer shall be suitable for outdoor use in moist tropical climate and in areas the limiting weather conditions which the equipment has to withstand in service are given in Clause 4.2 of Chapter- 4 of this Specification.

3.2 The transformer shall also be subjected to vibrations on account of trains running on nearby railway tracks.

3.3 The amplitude of these vibrations which occur with rapidly varying time periods in the range of 15 to 70 ms lies in the range of 30 to 150 microns at present, with instantaneous peaks going up to 350 microns. These vibrations may become more severe as the speeds and loads of trains increase in future.

4 TRACTION POWER SUPPLY SYSTEMS : 2X25KV AT FEEDING SYSTEM

4.1 General Scheme

4.1.1 The electric power for railway traction is supplied at AC 50 Hz, single-phase through 2x25 kV AT feeding system, which has a feeding voltage (2x25 kV) from the traction substation (TSS) two times as high as the catenary voltage, which is 25 kV with respect to earth/rail. The power fed from the TSS through catenary and feeder wire is stepped

down to the catenary voltage by means of autotransformers (ATs) installed about every 13 to 17 km along the track, and then fed to the locomotives. In other words, both the catenary and feeder voltage are, 25 kV with respect to the earth/rail, although the substation feeding voltage between catenary and feeder wires is 50 kV. The catenary voltage is therefore, the same as that in the conventional 25 kV system.

- 4.1.2 The power supply shall be obtained from the 132 kV, three-phase, double circuit, effectively earthed transmission network of the Indian railways, at the TSS. The spacing between adjacent substations is normally 60 km .
- 4.1.3 One outer terminal of the secondary windings of the traction transformer is connected to the catenary and the other outer terminal is connected to the feeder.
- 4.1.4 ATs shall be connected between 25 kV catenary and 25 kV negative feeder, with mid-point connected to rail and earth. Two adjacent AT's shall share power to feed trains at 25 kV/2x25kV system. The load current (current drawn by electric locomotives) from the TSS flows through the catenary and returns to the TSS through the negative feeder. For a train in an AT-cell (distance between two consecutive ATs), most of the current is fed to the electric locomotive by the ATs of that AT-cell. The Traction current returns in the rails/earth and is routed to the negative feeder through the neutral terminals of the autotransformers. The current in OHE, therefore, is an algebraic sum of 25 kV current feed to locomotives from AT and the 50 kV supply to ATs from the TSS.
- 4.1.5 Approximately midway between adjacent TSSs, a sectioning and paralleling post (SP) is provided. In order to prevent wrong phase coupling of power supply, a dead zone known as 'Neutral Section' is provided in the OHE opposite the TSS as well as SP. At the TSS, there are two-feeder circuit breakers for either side of the TSS for controlling the power fed to the OHE, in a double track section. Out of the two feeder circuit breakers for one side, one feeds the OHE of that side while the other remains (open) as standby. There is also a paralleling interrupter, which is normally closed, for either side of the TSS for paralleling the OHE of the UP and DOWN tracks. In case of fault in the OHE, the feeder circuit breaker of the TSS trips to isolate it. The Bridging Interrupter is used to feed one TSS up to the next TSS, in case the adjacent TSS is temporarily out of order.
- 4.1.6 For maintenance work and keeping the voltage drop within limit, one or more sub-sectioning and paralleling post (SSP) are provided between the TSS and SP. The supply control Posts are on an average located every 13-17 km interval. An SSP has four sectioning interrupters and one paralleling interrupter, whereas an SP has two bridging circuit breakers (which remain open under normal feeding condition) and two paralleling interrupters.

4.2 Protection System

- 4.2.1 The protection system of the traction transformer comprises the following:

1	Differential protection
2	Instantaneous and IDMT over-current, and earth fault protection on the primary side
3	Protection against phase-failure on the secondary side (i.e. to detect malfunction of feeder/transformer circuit breaker)
4	Buchholz Relay
5	Thermistor/Optical hot spot sensor. The Transformer should have built-in hot spot temperature devices to indicate and record the hot test spot temperature as per IEC-60076-2 (Ed. 3.0).
6	Temperature sensors for Transformer Oil. The Transformer should have built-in temperature devices to as per IEC-60076-2 (Ed. 3.0).

4.2.2 The protection systems for the OHE comprise the following:

1	Distance protection
2	Delta I type fault selective protection
3	Instantaneous over current protection
4	Under-voltage protection to avoid wrong phase coupling
5	Fault locating expert system based on AT voltage neutral current.

4.3 OHE General data

4.3.1 The OHE shall consists of (i) Contact wire of minimum 150 mm² cross section suspended directly from catenary of wire of minimum 120 mm² cross section by a number of vertical dropper wires, usually at regular intervals and (ii) a feeder wire of stranded all aluminium conductor.

4.4 Traction Transformer General Data

4.4.1 The transformer shall have 60/84/100 MVA power rating based on ONAN/ ONAF/OFAF cooling. The transformer shall be supplied with ONAN rating only.

4.4.2 However, provision shall be made by the contractor for installing cooling fans for operation in ONAF mode (84 MVA), as & when required by the employer.

4.4.3 Further, provision shall also be made by the contractor for installation of oil pump for operation in OFAF mode (100 MVA), as & when required by the employer.

4.5 Nature of traction loads and faults on the OHE system

4.5.1 The traction load is a frequently and rapidly varying one; between no load and overload. The TSS equipment is subject to frequent earth faults/short circuits caused by failure of Insulation, snapping of OHE touching earth, wire dropped by bird connecting the OHE to earth/ over line structure, and miscreant activity. On an average, the number of faults/ short circuits per month could be as high as 40. The magnitude of the fault current may vary between 40% and 100% of the dead short circuit value. These faults are cleared by the feeder circuit breaker on operation of the distance, delta I and instantaneous over-current relays associated with the concerned feeder circuit breaker. In 2x25 kV system faults can occur with: feeder-earth; feeder-OHE and OHE-earth faults or a combination of them.

4.5.2 The existing Indian Railways ac electric locomotives are provided with silicon rectifiers fed dc motors or GTO/IGBT based power converter fed 3-phase Induction Motors and the average power factor generally varies between 0.7 and 0.85 lagging, without reactive power compensation, which introduces harmonic currents in the 25kV power supply system.

4.5.3 On DFCC (Eastern), Locomotives are proposed to have VVVF drives and improved power factor closer to 0.98 and negligible harmonics. The traction supply may therefore be at higher power factor than those on IR.

4.6 Short-Circuit Apparent Power of the system

4.6.1 The short-circuit apparent power at the transformer location for various system voltages is as under:

Highest system voltage (kV)	Short circuit apparent power (MVA)
72.5	3,500
123	6,000
145	10,000
245	20,000

4.7 Auxiliary power supplies at TSS

4.7.1 The following auxiliary power supplies are available

1	110V dc from a battery
2	240 V ac, 50 Hz, single-phase from a 25/0.24 kV auxiliary transformer fed from Traction supply.

5 RATING AND GENERAL DATA

5.1 The rating and general data of the transformer shall be as follows:

S.No	Item	Description
1	Type	ONAN/ONAF/OFAP cooled, Scott-connected (3 phase/ 2 phase), step down power transformer, double limb wound, core/shell-type for outdoor installation.
2	Windings	Primary windings shall be T-connected for three phase supply. Two secondary windings, one per phase, Main-phase (M-phase) and Teaser-phase (T-phase), with a phase difference of 90 degree. The primary and secondary windings shall be uniformly insulated.
3	Rated Frequency (Hz)	50 ± 3%
4	Rated 3-phase primary voltage between phases Un (kV)	220/132
5	Highest 3-phase system voltage between phases Um (kV)	245/145
6	Rated 2-phase secondary voltage (at no load), (kV)	54 per phase
7	Rated power, (MVA)	60/84/100 MVA ONAN/ONAF/OFAP (Each secondary winding shall have a rated power of 30/42/50MVA)
8	Rated current at the principal tapping: i. Rated primary current (A) Un 220 kV Un 132 kV ii. Rated secondary current (A)	157.5 / 220.4 / 262.4 262.4 / 367.4 / 437.4 556 / 778 / 926 (for each secondary winding)
9	Percentage of impedance voltages, main/primary winding and teaser/primary winding at 30 MVA based at principal tapping.	%Z = 11-13%
10	Non-cumulative overload capacity on ONAN rating.	1) 150% rated load for 15 minutes 2) 200% rated load for 5 minutes
11	Polarity	Subtractive

S.No	Item	Description		
12	Tapping (off - circuit)	Separate tapped winding on primary winding to give rated secondary voltage for variation in primary voltage of +10% to -15%, in steps of 5% each.		
13	Temperature rise	1) Winding: 50K at rated load, and 60K for overloads as specified in Clause 5.1(10) (temperature measured by resistance method). 2) Top oil: 45K (temperature rise measured by thermometer). 3) Current carrying parts in air. 40K (temperature rise measured by thermometer).		
14	Maximum permissible losses at principal tap			
	1.No-load losses ,kW as per IEC 60076-1 clause 3.6.1	55 kW		
	2. Total load losses at the principal tapping including core, windings, frame parts, tank and auxiliary requirements as per IEC 60076-1 clause 3.6.3	275 kW at 60 MVA ONAN		
15	Ability to withstand short circuit: 1.Thermal ability 2.Dynamic ability	2s		
		0.5s		
16	Flux density at rated voltage and frequency at principal tapping.	Shall not exceed either 1.7 T.		
17	Current density in the windings.	Shall not exceed 2.5A/mm ² at 60MVA for ONAN.		
18	Acoustic sound level when energized at rated voltage and at no-load.	NEMA R-1-1993 (R2000) Table -2.		
19	Bushings	(iv) Item	(v) Secondary	Primary (220/132 kV)
		(vi) Type	OIP condenser	OIP condenser
		Highest voltage for equipment Um(kV)	54	245/145
		Rated current(A)	1250	800
		Minimum Creepage distance in air (mm)	1300	6125/3625
20	Bushings type current transformers for differential protection of transformer	Item	Secondary	Primary
		Highest voltage	52	245/145
		CT Ratio	1000/5	300/5, 600/5
		Frequency(Hz)	50 +/- 3%	50 +/- 3%
		Class of accuracy as	PX	PX

S.No	Item	Description		
		per IEC60044-1.		
		Minimum knee-point emf,(V)	150	125/175
		Maximum excitation current at knee-point voltage (A)	0.25	0.75
		Maximum resistance of the secondary winding, (Ω)	0.5	0.25

6 SALIENT DESIGN FEATURES

6.1 Overall dimensions

- 6.1.1 The overall dimensions of the transformer shall be kept as low as possible and in any case shall not exceed the transportation limit in India.

(Transportation dimension)

1	Length x Width (in mm)	14,000 x 6,500
2	Height of topmost point of primary bushing terminal	7,500 mm
3	Height of topmost point of secondary bushing terminal	5,500mm

- 6.1.2 The manufacturer shall, where practical, design the transformer so that with the bushings & accessories removed, the transformer shall fit within Indian Railway loading gauge, in case it is transported through rail, MMD to be enclosed with the offer.

- 6.1.3 The transformer should be designed nitrogen or dry air filled such that it can be transported without the Insulation oil inside the tank. The transformer shall be designed such that it can be transported with tank under pressure with nitrogen and other protective measures that the Manufacturer recommends, so that no moisture can enters the housing.

6.2 Tank

- 6.2.1 The tank for the transformer shall be of the top cover jointed with bolted connection. The bottom plate of main tank shall be firmly welded to the main body and the top cover is a plate reinforced with ribs. The winding and core shall fully exposed when the tank cover is lifted. A pressure gauge along with a hygrometer shall be provided so that the status of dryness of the winding can be assessed in the transformer prior to its heat run before commissioning.
- 6.2.2 The tank shall be constructed from mild steel of a quality that allows welding without any defect/ flaw, with a single tier construction, shaped so as to reduce welding to the minimum. The welded joints shall be made using good engineering practices. The tank shall be adequately strengthened for general rigidity to permit hoisting of the transformer filled with oil by crane. The tank body shall be designed to withstand against the full vacuum degree.
- 6.2.3 The tank shall be fitted with four lifting pads at the lower end to enable lifting of the transformer filled with oil by means of lifting jacks.
- 6.2.4 The tank shall be fitted with an under carriage and mounted on bidirectional swiveling type flanged rollers for being rolled on 1676mm (5' 6") gauge track, on which it shall also rest in the final position. The rollers shall be provided with detachable type locking

arrangement to enable their locking after installing the transformer in the final position, to hold the transformer fixed on foundation and to prevent any accidental movement of the transformer.

- 6.2.5 There shall be at least five inspection covers of suitable size on the tank to enable inspection of the lower portions of bushings, and the leads as well as the various connections of the motorised off-circuit tap-changer.
- 6.2.6 The gaskets with groove NBR (NITRILE BUTADIENE RUBBER) shall be provided for oil sealing points. The rubberized cork gasket may be used for other general portion.
- 6.2.7 All valves used in the transformer shall be capable to withstand full vacuum degree. The manufacturer shall ensure that suitable anti-theft measures like locked use of blanking plates are provided on these valves, so as to prevent pilferage/theft of oil during transit and service.

6.3 Marshalling Box

- 6.3.1 A vermin proof, weatherproof and well ventilated, marshalling box with IP class 55, made up of sheet steel of thickness not less than 2 mm, strengthened with adequate stiffeners, shall be provided on the left hand side of the transformer tank as viewed from the secondary terminals side. It shall have a hinged door, with provision for padlocking the door opening outward horizontally.
- 6.3.2 The marshalling box shall have a sloping roof. The top of the marshalling, box shall be at a height of about 2 m from the transformer rail level.
- 6.3.3 The marshalling box, shall house the winding and oil temperature indicators and terminal board. To prevent condensation of moisture in the marshalling box, metal clad space heater controlled by an associated thermostat and switch shall be provided. Cable glands shall be provided for the incoming and outgoing cables.
- 6.3.4 The temperature indicators shall be so mounted such that their dials are at a height of not more than 1.6 m from the rail level. Transparent windows of tough acrylic plastic or similar non-fragile transparent material shall be, provided on the marshalling box, so as to enable reading of the temperature indicators without opening the door of the marshalling box
- 6.3.5 All cables from the bushing current transformers, Buchholz relay, magnetic oil level gauge, pressure relief device and, temperature indicators shall be run up to the marshalling box. The cables shall be of 1100 V grade, XLPE insulated, XLPE sheathed, steel wire armored, stranded copper conductor conforming to IEC 60502-1. The cables shall, be adequately insulated for heat from the tank surface and the sun.
- 6.3.6 All wiring in the marshalling box shall be clearly identified by lettered/figured ferrules of the interlock type, preferably of yellow colour with-black letters/figures. The ac and dc circuits shall be clearly distinguished and well separated from each other.
- 6.3.7 Suitable legend and schematic diagram plates made of anodized aluminium with black lettering and lines shall be fixed on the inside surface of the marshalling box door.

6.4 Core

- 6.4.1 The core shall be built-up of high permeability cold rolled grain oriented silicon steel laminations conforming to JIS C2553 or equivalent IS as indicated in Table No. 2.1-1. The flux density in any part of the core and yokes at the principal tapping with primary winding excited at the rated primary voltage and frequency shall not exceed 1.7 T. The successful bidder / manufacturer shall furnish calculations to prove that this value shall not be exceeded.

- 6.4.2 The lamination for the core shall be free from waves, deformations and signs of rust. Both sides of the laminations shall be coated with suitable Insulation capable of withstanding stress relief annealing. In assembling the core, air gaps shall be avoided. Necessary cooling ducts shall be provided in the core and yoke for heat dissipation. The core clamping frame shall be provided with lifting eyes for the purpose of tanking and un-tanking the core and winding of the transformer.
- 6.4.3 The core shall be electrically solidly connected to the tank.
- 6.4.4 Design of the Core shall be boltless and it shall be tightened by binding the laminations using resin glass tape. Core laminations shall be tested after completion of the core assembly to ensure that they withstand a voltage of 2 kV r.m.s with respect to core for duration of 60 seconds.
- 6.4.5 The transformer is required to be continuously in service, preferably without requiring any attention from the date of its energization up to the periodical overhaul (POH), which is generally done after 10-12 years of service. The successful bidder/ manufacturer of the transformer shall, take this aspect into account during core assembly/manufacture and indicate measures taken by them to ensure suitable clamping to permit the above frequency and cover this in their instruction manual.

6.5 Windings

- 6.5.1 The winding shall be of disc/interleaved/inter-shield/rectangular pancake type for the primary and of disc/helical/cylindrical/rectangular pancake type for the secondary windings. The primary and secondary windings shall be uniformly insulated. All the four terminals of both secondary windings of 'M' and 'T' phases shall be brought out separately through 54 kV OIP condenser bushings, for cascade connection externally. The QAP of the manufacturing process is to be submitted along with the bid.
- 6.5.2 The workmanship shall be of high quality in keeping with Good Engineering Practices and as for Insulation, insulating materials of class A or higher should only be used.
- 6.5.3 No joint shall be used in the winding conductor, in principle, except for inter-leave joint.
- 6.5.4 Separate tapped coil shall be provided for each primary winding for connection of the motorized off-circuit tap-changer. The tapped coils shall be distributed in multi-sections in order to reduce the imbalance in ampere turns to the minimum at any tap position.
- 6.5.5 Separate tapped winding shall be provided for each primary winding. The transformer windings shall be designed for the following rated withstand voltages:

	Item	Secondary	Primary (220/132 kV)
1	Highest voltage for equipment Um(kV)	52	245/145
2	Rated short duration power frequency withstand voltage (kV)	95	395/275
3	Rated lightning impulse withstand voltage (kV peak)	250	950/650

- 6.5.6 The windings shall be so designed that the transfer of lightning and switching surges from primary to secondary windings and vice-versa is kept to the minimum level.
- 6.5.7 The axial pre-compression on the windings shall not be less than the double the calculated axial thrust that may be set up under dead short-circuit condition so; as to ensure that the windings do not become loose due to frequent short circuits in service.
- 6.5.8 During short circuits, the stresses set up in conductors, spacers, end blocks, clamping, rings and such other parts of the transformer; shall not exceed one third of the maximum

permissible values.

- 6.5.9 Pre-compressed spacers shall be used between disc shaped coils of the windings to transmit the axial forces generated due to the short circuits.
- 6.5.10 A uniform shrinkage shall be ensured during the drying of the individual coils or assembly of coils by providing a uniform clamping force with the help of hydraulic jacks or similar devices.
- 6.5.11 In order to keep unbalanced axial force due to non-uniform shrinkage/unequal height of the coils to the minimum, wedges of pre-compressed wood or similar such material shall be used.
- 6.5.12 The successful bidder/ manufacturer shall ensure that there is no further shrinkage of the coil assembly in any additional cycle after the final curing.
- 6.5.13 The separate winding compression structure suitable shall be provided apart from the core clamping structure in order to not causing any loose. The equal axial force compression system shall be applied on to each assembled windings throughout the drying process and fixing with the high tension self-tightening structure to eliminate any loose unbalanced face due to non-uniform shrinkage of windings. To prevent displacement of the radial spacers used in the windings, closed slots shall be provided.
- 6.5.14 The vertical locking strips and slots of the radial spacers shall be so designed as to withstand the-forces generated due to short circuits.
- 6.5.15 The vertical locking strips and radial spacers shall be made of pre-compressed pressboard conforming to grade PSP: 3052 of DIN 7733.
- 6.5.16 To prevent end blocks from shifting, pre-compressed pressboard ring shall be provided in between the two adjacent blocks. Coil clamping rings made of densified wood or mild steel shall be located in position with pressure screws.
- 6.5.17 Leads from the windings to the terminals, from the tap switch to the tapplings of the primary windings and other interconnections shall be properly supported and secured.
- 6.5.18 The following particulars/ documents in respect of the radial spacer blocks (winding blocks), vertical locking strips (axial ribs), end blocks, insulating cylinder, angle rings, paper Insulation of the conductor and coil clamping plates used in the manufacture of the windings shall be furnished.
- i. Reference to specification-and grade of material.
 - ii. Source(s) of supply,
 - iii. Test certificates.

7 INSULATING OIL

- 7.1 The transformer shall be supplied with new inhibited mineral insulating oil conforming to IS12463. In addition, 10% extra oil by volume, shall be supplied in nonreturnable steel drums. The characteristics of the insulating oil before energisation of service shall conform to IS1866.

8 BUSHINGS AND TERMINAL CONNECTORS

- 8.1 Both the primary and secondary side bushings shall conform to IEC 60137. On the primary, side, sealed draw lead type Oil Impregnated Paper (OIP) condenser bushings shall be used. On the secondary side, sealed solid stem type OIP condenser bushings

shall be used.

8.2 The bushings shall have a non-breathing oil expansion chamber. The expansion chamber shall be provided with an oil level indicator, which shall be so designed and dimensioned that oil level is clearly visible from ground level.

8.3 A test tap shall be provided for dielectric or power factor measurement.

8.4 The bushings shall be designed for the following Insulation level:

1	Highest voltage for equipment Um (kV)	52	245/145
2	Rated short duration wet power frequency withstand voltage (kV)	95	460/275
3	Rated lightning impulse withstand voltage (kV peak)	250	1050/650

8.5 Adjustable arcing horns shall be provided on both the primary and secondary bushings. The horn gap setting shall be variable as indicated below:

1.	Highest voltage for equipment Um, kV	52	245/145
2.	Horn gap setting variable between, mm	150 and 300	1200 and 1500 500 and 900

8.6 The design and construction of the bushing shall be such that stresses due to expansion and contraction in any part of the bushings shall not lead to its deterioration breakage. The bushings shall be free from corona and shall not cause radio interference.

8.7 The bushing terminals shall be provided with terminal connectors of bimetallic type and shall be such that there is no hot spot formation even during the extreme over load condition of ONAN rating with 200% over loading.

8.8 The terminal connectors shall conform to IS: 5561. The design shall be such as to be connected to the equipment terminal stud with a minimum of four 12 mm diameter bolts, nuts, spring and flat washers.

9 BUSHING TYPE CURRENT TRANSFORMERS

9.1 The 52 kV and 245/145 kV bushings shall be so arranged as to accommodate bushing type current transformers (BCTs) for the biased differential protection of the transformer. The BCTs shall conform to IEC 60044-1 and meet with the stipulations in Clause 5.1(20) of this document.

9.2 The BCTs shall be so designed as to withstand thermal and mechanical stresses resulting from frequent short circuits experienced by the transformer on which these are fitted.

9.3 Apart from the BCTs required for the biased differential protection, BCT of accuracy class 5 and conforming to IEC 60044-1, with suitable tapplings, shall be mounted inside one bushing of the left-hand side (as viewed, from the. secondary; terminals, side) of each secondary winding 'M' and 'T' phases for use with the-winding temperature indicators.

9.4 The BCTs and the bushings shall be so mounted so that removal of a bushing can be achieved without disturbing the current transformers, terminals and connections or pipe work is easy and convenient.

9.5 The leads from the BCTs shall be terminated in terminal boxes provided on the bushing turrets. Suitable links shall be provided in the terminal boxes for shorting the secondary terminals of the BCTs, when not connected to the external measuring circuits.

- 9.6 The leads from the secondary winding of the BCT terminated in the terminal box on the bushing turret up to the marshalling box shall be of 1100 V grade, XLPE insulated, XLPE sheathed, steel wire armoured, stranded copper cable of cross section not less than 4 mm² to IEC 60502-1.
- 9.7 Cable glands of proper size shall be provided in the terminal boxes to lead in/lead out the cables.

10 CLEARANCES

- 10.1 The relative orientation in space of the bushings fitted with terminal connectors the main tank, radiators, conservator, pressure relief device, oil piping and other parts when mounted on the transformer shall be such that the various clearances in air from bushing live parts shall not be less than the appropriate values given here under:

1	Highest voltage for equipment Um(kV)	52	245/145
2	Minimum clearance (mm)	500	1900/1200

The same distance shall apply for clearances phase-to-earth (including oil piping work, conservator, pressure relief device and such other parts), phase-to-phase and towards terminals of a lower voltage winding.

11 MOTORISED OFF-LOAD TAP-CHANGER

- 11.1 The transformer shall be fitted with a motor operated off-circuit rotary type tap-changer, to cater for the voltage, range specified in Clause 5.1(12) of this document. Visibility of the tap position should be such that display is legible. The motor drive unit shall be installed in a weather and corrosion proof adequately ventilated cubicle made of sheet steel not less than 2 mm thick with adequate stiffeners to prevent deformation during transit and handling. The cubicle shall have a sloping roof. The top of the cubicle shall be at a height of about 1.5 m from the rail level. The cubicle shall be so positioned that the hinge of the operating handle for manual operation is at a height of about 1.1 m from the rail level.
- 11.2 To prevent condensation of moisture in the cubicle, metal clad space heater, controlled by an associated thermostat and switch, shall be provided.
- 11.3 All wiring in the cubicle shall be clearly identified by lettered/figured ferrules of the interlock type, preferable of yellow colour with black letters/figures. The ac and dc circuits shall be clearly distinguished and well separated from each other.
- 11.4 Suitable legend and schematic diagram plates made of anodized aluminium with black lettering and lines shall be fixed on the inside surface of the cubicle door.
- 11.5 A tap position indicator shall be provided to indicate the tap position which shall be clearly visible to an operator standing on the ground.
- 11.6 The tap-changer motor shall be suitable for operation off 110 V from a battery. The voltage at the battery terminals may vary between 110% and 85% of the normal value. The voltage at the tap-changer motor terminals is likely to be less than 85% of the normal value of 110 V due to voltage drop in control cable.
- 11.7 The circuit for the tap changer motor shall be such that the roller does not get stuck between the two taps, should the 110 VDC supply to the motor fails.
- 11.8 The tap-changer shall be provided with suitable interlocking arrangement to prevent its

operation (including manual tap changing) when either one or both circuit breakers on the primary as well as on the secondary sides of the transformer is/are in closed condition.

- 11.9 The tap-changer and its control circuit shall be designed for operation from the Remote Control Centre (RCC) by the Traction Power Controller (TPC) as well as from the tap-changer cubicle. A local/remote switch as well as necessary terminations for tele-signals and tele-commands from and to the tap-changer-for-operation from the RCC-shall therefore be provided in the tap-changer cubicle.

12 COOLING EQUIPMENT

- 12.1 The transformer shall be designed to be ONAN/ONAF/OFAF Cooled. The transformer shall be designed such that in case of emergency feed extension, it shall be capable of delivering 40% more of the ONAN rating based on the installation and commissioning of forced cooling and 100 MVA when oil pumps are further installed in future.
- 12.2 The fans shall be designed with 50% redundancy.
- 12.3 The fans shall be fitted with fan failure alarms. These alarms shall be routed back to the marshalling box, for connection to the SCADA system. There shall be visual indication in the marshalling box as to which fan group has failed.
- 12.4 The radiators shall consist of a pressed steel plate assembly formed into elliptical oil channels as per IEEMA Standard. The radiators shall be designed in such a manner that the temperature-rise limits specified under Clause 5.1 (13) of this document are not exceeded.
- 12.5 The radiators shall be removable (after isolating the same from the main tank) to facilitate transportation of the transformer. A drain plug of size 19 mm and an air-release plug of size 19 mm shall be provided at the bottom and at the top of each radiator bank for draining and filling of oil respectively. Each radiator bank shall also be provided with shut-off valves. If radiators are supplied as a separate unit, then body bellows type flexible joints shall be provided on the oil headers.
- 12.6 The radiators shall preferable be supported directly on the transformer tank. Each radiator bank shall be fitted with lifting lugs.

13 PARTS, FITTINGS AND ACCESSORIES

- 13.1 Apart from the parts, fittings and accessories specifically detailed in the foregoing Clauses, the parts, fittings and accessories detailed hereunder shall be supplied with each transformer.
- 13.1.1 **Conservator Tank:** It shall be of adequate capacity and complete with supporting bracket or structure, oil filling cap and drain valve of size 25 mm. The cylindrical portion of the conservator tank shall be of single piece construction without any gasket joint. Suitable air cell/ separator arrangement of high quality material shall be provided in the conservator to ensure that the transformer insulating oil does not come in contact with air. The material of cell / separator shall be coated fabric consisting of highly resistant polyamide fabric, externally coated with perfectly transformer oil resisting coating (Chemical), inner coating resisting ozone & weathering. Suitable instructions may be provided for installation/ commissioning & maintenance of air cell / separator arrangement.
- 13.1.2 **Oil Level Gauge:** It shall be of magnetic type having a dial diameter of 200 to 250 mm.

The gauge shall have markings corresponding to minimum oil level, maximum oil level and oil level corresponding to oil temperature of 30°C, 45°C and 85°C. The oil level indicator shall be so designed and mounted that the oil level is clearly visible to an operator standing on the ground. The oil level gauge shall be fitted with two SCADA readable contacts. The first contact shall provide a warning that the oil level is at 25% above the minimum level. The second contact shall indicate when the minimum oil level has been reached.

- 13.1.3 **Silica Gel Breather:** It shall be complete with oil seal and connecting pipes. The connecting pipes shall be secured properly. The container of the silica gel breather shall be of transparent flexi glass or similar material suitable for outdoor application.
- 13.1.3.1 Orange silica gel (round balls 2 to 5 mm) with quantity of two DT-8 silica gel connecting with flanged mounting two pipes control through different valves as per DIN: 42567 & IS: 6401 to be provided.
- 13.1.4 **Pressure Relief Device:** Shroud Pressure Relief Device will be used and have provision of discharge of oil from PRD to safe place by closed pipeline. This avoids hazards of fire and it is safe to persons working near Transformer & it is environment friendly. It shall be designed to operate to release internal pressure at preset value without endangering the equipment or operator & shall be of instantaneous reset type.
- 13.1.5 **Filter Valves:** The bottom and upper filter valves shall be of 50 mm size and suitably baffled to reduce aeration of oil. The valves shall be flanged to seat 40 mm adopter threaded to thread size P 1-1/2 for connection to oil filtration plant.
- 13.1.6 **Drain Valve:** It shall be of size 80 mm fitted with an oil sampling device of size 15mm.
- 13.1.7 **Earthing Terminals:** Two earthing terminals of adequate size shall be provided on the tank for its earthing with the help of 3 mild steel flats, each of size 75 mm x 8 mm. The terminals shall be clearly marked for earthing.
- 13.1.8 **Buchholz Relay:** It shall be of double float type, with two shut-off valves of 80 mm size, one between the conservator tank and the Buchholz relay and the other/between the transformer tank and the Buchholz relay. The relay shall have one alarm contact and one trip contact, none of the contacts being earthed. The contacts shall be of mercury/micro switch type, electrically independent and wired up to the marshalling box. A testing petcock shall be brought down through a pipe for the purpose of sampling the gas, if any, collected in the Buchholz relay.
- 13.1.9 **Oil temperature indicator (OTI):** It shall have one alarm contact, one trip contact and two normally open spare contacts none of the contacts being earthed. The contacts shall be electrically independent.
- 13.1.10 **Winding temperature indicator (WTI):** Two WTIs shall be provided, one for the M-phase and the other for the T-phase. Each WTI shall have one alarm contact, one trip contact and two normally open spare contacts, none of the contacts being earthed. The contacts shall be electrically independent.
- The windings shall also be fitted with analogue temperature sensors/thermistors/optical sensors that are suitable for being remote read via the SCADA system.
- 13.1.11 **Thermometer Pockets:** A separate thermometer pocket with cap shall .be provided on the tank for measuring the top oil temperature in the tank. The thermometer shall indicate hot spot temperature.
- 13.1.12 **Rating Plate:** The rating plate shall indicate the following:
- The ratings of the transformer

- The connection diagram of the windings
- The particulars of the bushing current transformers
- Weight without oil
- Weight with oil
- Kind of transformer (I.e. Scott Connected traction transformer)
- Manufacturer
- Date of manufacture
- Serial number
- Rated Voltages in (kV) and tapping range
- Rated primary and secondary currents
- Short circuit impedance
- Type of cooling
- Other details as per IEC 60076-1.

The rating plate shall be both in English and Hindi version.

13.2 All valves shall be of the double flange type and fitted with suitable blanking plates on the outer face of the exposed flange.

13.3 The capillary tubes for temperature indicators shall be able to withstand normal bending. They shall be supported properly without sharp or repeated bends or twists.

13.4 Fibre Optic Hot Winding Temperature Monitor

Fibre optical winding hot spot temperature monitor to be provided with the transformer windings, connected in addition to the winding temperature indicator in parallel to measure transformer winding hot spots in real time and activate control of the cooling system. The fibre to be given high strength casing through rugged jacketing and fibre to be securely routed till the tank wall plate. The application of fibre optic shall be governed by IEC-60076-2 (Ed. 3.0).

Specification for Fibre Optic Temperature Measurement System

Fiber optic based temperature measurement of Oil and windings shall be done using Fiber Optic Sensors meeting following broad criteria:

13.4.1 System shall be of proven technology. The temperature sensing tip of the fiber optic shall be ruggedized. The probes shall be directly installed in each winding of power transformer to measure the winding hot spot and at the top oil temperature. There shall be at least 4 probes inside the transformer.

13.4.2 Out of the 4 probes one probe shall be used for top oil temperature measurement, one for winding and balance two for LV windings.

13.4.3 Probes shall be able to be completely immersed in hot transformer oil. They shall withstand exposure to hot vapour during the transformer Insulation drying process, as part of Vacuum Phase Drying (VPD). The probes shall meet the requirement to eliminate the possibility of partial discharge in high electric stress areas in the transformer. Probes shall preferably have certified Weidman testing for electrical parameters as per ASTM D-3426 and ASTM D-149 that is current (no more than 1 year old). Test results and studies to be submitted by the transformer manufacturer along with

the first unit of a certain type of traction power transformer.

- 13.4.4 Temperature range of the system should be up to +200°C without any need of recalibration. Probes must connect to the tank wall plate with threaded connectors containing a Viton O-ring to prevent against oil leakage.
- 13.4.5 Probes shall be of material inert to mineral and ester oils, multiple jacketed (Kevlar preferred), perforated out jacket to allow complete oil filling and mechanical strength.
- 13.4.6 System should include analog outputs for each measurement channel. Temperature resolution of the analog outputs shall be $\pm 0.1^\circ\text{C}$ and precision of $\pm 0.5^\circ\text{C}$ and the system shall offer user programmable temperature alarm outputs with 8 relays. The cooling system (Fans & Pumps) should be operated through these relays. The temperature settings for the relays shall be made as per the end-user request.
- 13.4.7 All inputs and outputs of the system shall meet the requirements of surge test of IEEE C37.90.1-2002. The system should electronically store testing records of components and allow for on board diagnostics and instructions, including a signal strength reading to verify integrity of fiber optic connections. System should contain a battery for date/time stamp of data readings. The system should comply with IEC61850 protocol, along with DNP 3.0, Modbus, TCP/IP and ASCII.
- 13.4.8 The transformer manufacturer should submit details showing that the probes are located in the hottest point of the winding, while submitting Drawings for approval. The manufacturer are free to use more than 4 probes if design so required.
- 13.4.9 The controller shall be housed in cooler cubicle or in a separate enclosure having ingress protection IP 56.
- 13.4.10 Temperature Rise Test Measurements shall be made with the Fiber Optic Thermometers.
- 13.5 The manufacturers of Part, Fittings & Accessories for the transformer shall be mentioned in the SOGP/BOM & got approved. During prototype test, the accessories will be tested & performance monitored by either at Customer Hold Point (CHP) or by Test Certificate (TC) Verification.

The equipment shall be operational during temperature tests and be demonstrated during these tests. During probe verification, the hottest probes for each phase shall be identified and temperature data for all probes recorded and reported in the test report.

In case manufacturers desire to change a particular make of accessory, prior approval of Engineer shall be required and SOGP as well as Bill of Material (BOM) shall have to be got approved from Engineer.

In case of make of accessories approved under Customer Hold Point (CHP) for regular production, the Engineer's approval shall be required separately on SOGP and BOM. The Traction Power Transformer manufacturer shall be responsible for availability of compatible accessories for the equipment approved.

14 FASTENERS

- 14.1 All fasteners of 12 mm diameter and less exposed, to atmosphere shall be of stainless steel and those above 12 mm diameter shall preferably be of stainless steel or of, mild steel hot dip galvanized to 610g/m of zinc. The material of the stainless steel fasteners shall conform to IS: 1570 (Part-V), Grade 04Cr17Ni12Mo2 or equivalents

15 PAINTING

- 15.1 Shot blasting/ sand blasting shall be done on the transformer tank to remove all scales rust and other residue, before applying the paint inside the tank. All steel surfaces which are in contact with insulating oil shall be painted with heat resistant oil-insoluble insulating varnish. All steel surfaces exposed to weather shall be given, one primer coat of zinc chromate and two coats of anti-corrosion grey paint. The touch-up of gray paint shall be applied at site by, the manufacturer.

16 TESTING OF TRANSFORMER

16.1 General

- 16.1.1 The designs and Drawings of transformer together with detailed calculations & the Quality Assurance Plan (QAP) shall be furnished to the Engineer, within the period stipulated in the contract. Only after all the designs and Drawings as well as the QAP have been-approved for prototype tests and a written advice given to that effect, shall the successful bidder/manufacturer take up manufacture of the prototype of the transformer. It is to be clearly understood that any change or modification required by the above authorities to be done in the prototype shall be done expeditiously, notwithstanding approval having already been given for the, designs and Drawings. Such change or modification shall be incorporated in the Drawings.

- 16.1.2 Prior to giving a call to the Engineer for inspection and testing of the prototype, the successful bidder/manufacturer shall submit a detailed test, schedule consisting of schematic circuit diagrams, for each of the tests and the number of days required to complete all the tests at one stretch. Once the schedule is approved, the tests shall invariably be done accordingly. In case any dispute or disagreement arises between the successful bidder/manufacturer and representative of the Engineer during the process of testing as regards the procedure for type tests and/or the interpretation and acceptability of the results of type tests, it shall be brought to the notice of the Engineer, as the case may be, whose decision shall be final and binding. Only after the prototype transformer is completed and ready in each and every respect, shall the successful bidder/manufacturer give the actual call for the inspection and testing.

- 16.1.3 The type tests shall be carried out on the prototype transformer at the works of the successful bidder/manufacturer or at reputed testing laboratory in the presence of the representative of the Engineer, in accordance with the relevant specifications and as modified or amplified by this document.

16.2 Tests during manufacture

- 16.2.1 Though the tests described below shall form part of the type tests, the manufacturer shall carry out these tests on each unit during the process of manufacture and submit the test reports to the Engineer deputed for witnessing the routine tests:

- Oil leakage test.
- Vacuum test.
- Pressure test.
- Test for pressure relief device.
- Measurement of capacitance and tan-delta values.

- 16.2.2 **Oil Leakage Test:** The transformer with its radiators, conservator tank and other parts,

fittings and accessories completely, assembled shall be tested for oil leakage by being filled with oil conforming to IEC 60296 at the ambient temperature and subjected to a pressure corresponding to twice the normal static oil head or to the normal static oil head plus 35 kN/m² (0.35 kgf/cm²) whichever is lower, the static oil head being measured at the base of the tank. This pressure shall be maintained for a period of not less than 12 hr., during which time no leakage shall occur.

16.2.3 **Vacuum Test:** The transformer tank only shall be tested at a vacuum of 3.33 kN/m² (0.0333 kgf/cm²) for 60 min. The permanent deflection of flat plates after release of vacuum shall not exceed the values specified below:

Horizontal length of flat plate	Permanent deflection (mm)
Up to and including 750mm	5.0
751mm to 1250mm	6.5
1251mm to 1750mm	8.0
1751mm to 2000mm	9.5
2001mm to 2250mm	11.0
2251mm to 2500mm	12.5
2501mm to 3000mm	16.0
Above 3000mm	19.0

16.2.4 **Pressure Test:** Every transformer tank, radiator and conservator tank shall be subjected to an air pressure corresponding to twice the normal static head of oil or to normal static oil head pressure plus 35 kN/m² (0.35 kgf/cm²) whichever is lower as measured at the base of the tank. The pressure shall remain constant for 1 hour to indicate that there is no leakage.

16.2.5 **Test of Pressure Relief Device:** Every pressure relief device shall be subjected to gradually increasing oil pressure. It shall operate before the pressure reaches the test pressure specified in Clause 16.2.1.3 hereof and the value; at which it has operated shall be recorded.

16.2.6 **Measurement of capacitance and Tan-Delta values:** The measurement of capacitance and tan-delta (dielectric loss factor) of the transformer windings shall be made by Schering Bridge.

16.3 Type Tests

16.3.1 General

The type tests shall be carried out on the prototype transformer at the works of the successful bidder/manufacturer or at any reputed laboratory in the presence of the representative of the Engineer and in accordance with the relevant specifications and as altered, amended or supplemented by this document. Amongst others, the following shall constitute the type tests:

- i. Temperature-rise test
- ii. Lightning impulse test.
- iii. Test with lightning impulse stopped on the tail
- iv. Short circuit test.
- v. Measurement of acoustic sound level.

- vi. Measurement of partial discharge quantity.
- vii. Measurement of harmonics of no-load current.

16.3.2 Temperature-rise test:

16.3.2.1 The temperature rise test shall be done with the tap changer on the lowest tap position (-15%), in accordance with IEC60076-2 except as modified hereunder.

1	At rated load at ONAN, ONAF, OFAF rating.
2	At 150% rated load for 15min after continuous operation at rated load for 1hr. at ONAN rating
3	At 200% rated load for 5 minutes after continuous operation at rated load for one hour at ONAN rating.

The tests shall be done continuously without any power supply interruption. In case interruptions of power supply do take place for some reason, then the entire test shall: be repeated after steady state conditions are attained.

16.3.2.2 The points to be ensured during the temperature rise test shall be:

1	The ambient temperature shall be measured using calibrated thermometers only
2	The winding temperature shall be determined by the resistance method only.
3	The temperature of the top oil shall be measured calibrated thermometer placed in an oil-filled thermometer pocket.
4	The average oil temperature shall be calculated as the difference between the top oil temperature and half the temperature drop in the cooling equipment (radiators)
5	The temperature of the hot-spot in the winding shall be the sum of the temperature of the top oil and 'H' times the temperature rise of the winding above the average oil temperature, where 'H' is the hot spot factor as per IEC 600076-2 and 60076-7.

16.3.2.3 The test shall be carried out as described below:

16.3.2.3.1 100% load

1	A quantum of power equal to the sum of the measured losses viz. no-load and load losses measured at minus 15% tap position, /corrected to 75 ⁰ C plus 10% of such sum shall be fed to the primary winding of the, transformer with the secondary windings short-circuited.
2	The power so fed to the transformer shall be continuously maintained till such time as the steady state temperature is reached i.e. the top oil temperature rise does not vary by more than 1 ⁰ C during four consecutive hourly readings
3	On attaining the steady state temperature, the current in the primary winding of the transformer shall be brought to the rated current which shall-be maintained for one hour. At the end of the period the power supply to the transformer shall be switched off and the time of Switching off recorded
4	The measurement of resistance shall commence as soon as is possible after switching off. The first reading of the resistance shall be taken as soon as possible, before the expiry of 90 seconds from the instant of switching off and the first ten readings shall be taken at intervals of 15s apart. Thereafter, another ten readings shall be taken at intervals of 30s apart.
5	The time at which each of the resistance values is read shall also be recorded.
6	The temperatures of the ambient, top oil, the top and bottom radiator header oils

	shall also be recorded at half-hourly intervals throughout the test starting from the instant power supply is; switched on to commence the if test till it is switched off.
7	The WTI and OTI readings shall also be recorded at half hourly intervals right from the instant the power supply is switched on to commence the test till it is switched off
8	After power supply is switched off the readings of OTI and WTI shall be recorded at intervals of 1 min apart for 30 min

16.3.2.3.2 150% load

1	After completion, of the test at 100% load, the transformer shall be fed with power which shall be a value so as to cause circulation of the rated current in the primary, winding with secondary windings short circuited. This current shall be circulated for 1h.
2	The current shall thereafter be increased to 150% of the rated current and maintained-for a" period of 15min. At the end of the 15 min period the power supply shall be switched off and the time of switching off recorded.
3	Thereafter the readings as indicated in Clause 16.3.2.3.1(4) to (8) shall be recorded.
4	The temperatures of ambient, top oil, the top and bottom radiator header oil and the temperatures indicated by OTI and WTI shall also be recorded at the time of switching on 150% load as well as at the time of switching off the power supply.

16.3.2.3.3 200% Load

1	After completion of the test at 150% load, the transformer shall be fed with power which shall be a value so as to cause circulation of rated current in the primary with the secondary windings short circuited. This current shall be circulated for 1hour.
2	The current shall thereafter be increased to 200% of the rated current and be maintained for 5minute period. At the end of the 5minute period the power supply shall be switched off and the time of switching off recorded.
3	Thereafter the readings as indicated in clause 16.3.2.3.1(4) to (8) shall be recorded.
4	The temperatures of ambient, top-oil, top and bottom radiator header oils and temperatures indicated by OTI and WTI shall also be recorded at the time of switching on the 200% load as well as the time of switching of the power supply.

16.3.2.4 Determination of thermal time constant of the windings: The thermal time constant of the primary and secondary windings under both rated load and overloads shall be verified during the temperature rise tests.

16.3.2.5 The temperature rise of the oil, windings and current carrying parts in air under both the overload conditions stipulated in clauses 16.3.2.3.2 and 16.3.2.3.3 above shall not exceed the values stipulated in clause 5.1(13) of this document. The windings hot-spot temperature under the overload conditions shall not exceed 115⁰C.

16.3.2.6 Testing and calibration of the temperature indicators: The functioning of the OTI and WTI shall be verified during the tests described above. Both the OTI and WTI shall be recalibrated, where necessary, to reflect the respective temperatures correctly. In particular, the reading of the WTI shall be the same as the calculated value of the hot-spot temperature of the winding.

16.3.2.7 Determination of the thermal time constant of the WTI: The thermal time constant of the WTI shall be determined for comparison with the thermal time constant of the windings of the transformer, with respect to the transformer oil. For this purpose, the indications of the WTI and the OTI shall be recorded every minute during the first 1 hour from the instant the transformer is loaded. From the slope of the curve plotted with time on the x-axis and the difference between the readings of the WTI and the OTI at particular time on the y-axis, the thermal time constant of the WTI shall be determined.

16.3.3 Lightning Impulse Test

16.3.3.1 This test shall be done in accordance with IEC 60076-3. Each of the terminals of the primary and secondary windings shall be tested with the following:

1	Highest voltage for equipment U_m (kV)	52	245/145
2	Lightning impulse withstand voltage (kV peak)	250	950/650

16.3.4 Test with lightning impulse, chopped on the tail

16.3.4.1 This test shall be done in accordance with IEC60076-3 with appropriate test voltage as stipulated in Clause 16.3.3.1 above.

16.3.5 Short Circuit Test

16.3.5.1 The short circuit test shall be conducted in accordance with IEC 60076-5 with the following schedule:

1. Insulation resistance of the windings with respect to the earth and the windings.
2. No load current
3. No load loss
4. Resistance of windings
5. Percentage impedance voltages.
6. Load loss
7. Voltage ratio
8. Di-electric test comprising:
 - Separate source voltage withstand test
 - Induced over voltage withstand test
9. Recording of Surge frequency Response Analysis (SFRA) at the highest (+10%), lowest (15%) and principal tapping as per IEC 60076-18.

16.3.5.2 The short circuit test may be performed either from the secondary side or the primary side. However test protocol need to be finalized with prior approval of the Engineer.

16.3.5.3 The transformer shall be subject to a total of seven shots in the following sequence:

1st Shot	Asymmetrical and symmetrical currents in M-phase and T-phase respectively at highest tap (+10%)
2nd Shot	Symmetrical and asymmetrical currents in the M-phase and T-phase

	respectively at the highest tap (+10%)
3rd Shot	Asymmetrical and symmetrical currents in M-phase and T-phase respectively at principle tap
4th Shot	Symmetrical and asymmetrical currents in the M-phase and T-phase respectively at the principle tap
5th Shot	Asymmetrical and symmetrical currents in M-phase and T-phase respectively at lowest tap (-15%)
6th Shot	Symmetrical and asymmetrical currents in the M-phase and T-phase respectively at the lowest tap (-15%)
7th Shot	Symmetrical currents in M-phase and T-phase at lowest tap (-15%)

16.3.5.4 The duration of each shot shall be 0.5s.

16.3.5.5 Measurements shall be done after each shot for the following:

1	Percentage impedance voltage
2	No-load current
3	No-load loss

16.3.5.6 Further testing and inspection of the transformer subjected to the short-circuit test shall be carried out as per IEC 60076-5 with the modification that:

1	The dielectric routine tests shall be at 100% of the original test value
2	The percentage impedance voltages measured after the short circuit test shall not vary by more than 2% from those measured before the sort circuit test.

16.3.5.7 On completion of the short circuit test the transformer shall be un-tanked for inspection of the core and windings. In case the inspection of the core and windings do not reveal any apparent defects and the results of the short circuit test, the values of percentage impedance voltages as also the results of the route tests done after the short circuit test are in order the transformer will be deemed to have passed the short circuit.

If any of the results of the tests are not in order or the inspection of the core and winding reveals any defects, then the transformer shall be dismantled for detailed inspection.

16.3.6 Measurement of acoustic sound level

Measurement of acoustic sound level of the transformer energized at rated voltage and frequency shall be carried out as per IEC60076-10.

16.3.7 Measurement of Partial discharge quantity

16.3.7.1 Partial discharge quantity of the windings shall be measured in accordance with IEC 60076-3.

16.3.8 Measurement of harmonic of no-load current

16.3.8.1 The magnitude of harmonics of no-load current, as expressed in percentage of the fundamental, shall be measured by means of a harmonic analyzer, in accordance with IEC 60076-1.

16.3.9 Test with lightning impulse, chopped on the tail:

16.3.9.1 This test shall be done in accordance with IEC 60076-3 with appropriate test voltage as stipulated in Clause 16.3.3.1 above.

16.4 Type tests on parts, fittings and accessories

16.4.1 Tests for motorized off circuit tap changer

16.4.1.1 Though there are no Indian Standards Specifications at present for motorized off-circuit tap-changer, the following test shall be carried out thereon in accordance with IEC 60214.

16.4.1.2 **Tests for temperature rise of contacts:** The test shall be carried out at rated current of 1250A. The temperature rise shall not exceed the limit specified in IEC 60214.

16.4.1.3 **Mechanical endurance test:** With the tap changer in oil, 1000 operations shall be done manually. An operation shall comprise moving the tap changer from one tap position to the next higher or low tap position. All the taps of the tap changer i.e. 10% position tap through to the 15% tap shall be covered during the test.

16.4.1.4 **Milli Volt drop tests:** The test shall be done both before and after the mechanical endurance test to access the condition of contacts. The variation in millivolt drop values shall not be more that 20%.

16.4.1.5 **Short Circuit current test:** The test shall be done in accordance with IEC60214 with short circuit currents of 4 kA r.m.s, each 5s duration.

16.4.1.6 **Dielectric tests:** The test shall be done in accordance with IEC 60214.

16.4.2 Condenser Bushings

16.4.2.1 The type tests shall be carried out in accordance with IEC 60137 on porcelain housing of the condenser bushings. The following shall constitute the type test:

1. Visual inspection
2. Verification of dimensions
3. Electrical routine test
4. Porosity test
5. Temperature cycle test
6. Bending test

16.4.2.2 The type tests shall be carried out in accordance with IEC 60137 on prototype of the condenser bushing. The following shall constitute the type test:

1. Wet power frequency withstand voltage test
2. Dry lightning impulse voltage test
3. Thermal stability test
4. Temperature rise test
5. Thermal short time current withstand test
6. Dynamic current withstand test
7. Cantilever load withstand test
8. Tightness test
9. Test of tap Insulation
10. Tightness at flange or other fixing device
11. Measurement of partial discharge quantity.

16.4.3 Bushing type current transformers

16.4.3.1 The bushing type current transformers shall be tested in accordance with IEC60044-1.

16.4.4 Buchholz relay

16.4.4.1 The Buchholz relay shall be tested in accordance with IS: 3637

16.4.5 Terminal connector

16.4.5.1 The terminal connectors shall be tested in accordance with IS: 5561

16.4.6 Temperature indicators

16.4.6.1 The following tests shall be conducted on prototypes of OTI and WTI:

1	Accuracy with reference to a standard instrument
2	Calibration of the indicators to reflect the actual temperature of the oil/ windings
3	Dielectric test at 2.5kV for 60s.
4	Vibration test.
5	Dust and water splash test to IP55 degree of protection.

16.4.7 Pressure Relief Device

16.4.7.1 The following tests shall be conducted on the prototype of the pressure relief device:

1. Air pressure test.
2. Leakage test
3. Contact rating and operation test
4. Dielectric test on contacts at 2.5 kV for 60s.

16.4.8 Radiators

16.4.8.1 The radiators shall be tested for air leakage at a pressure of 2.5 kg/cm². The pressure shall remain constant for 1h to indicate that there is no leakage.

16.5 Insulating Oil

16.5.1 The following tests shall be carried out in accordance with IEC60296 on the sample of new insulating oil for use in the prototype transformer:

1. Density at 27 °C
2. Kinetic viscosity at 27 °C
3. Interfacial tension at 27 °C
4. Flash point.
5. Neutralisation value (acidity)
6. Electric strength (with 2.5mm gap)
7. Dielectric dissipation factor (tan-delta)
8. Specific resistance at 27 °C and at 90 °C
9. Oxidation stability
10. Water content.

16.6 Routine tests

16.6.1 The following routine tests shall be undertaken on each transformer including the prototype unit in accordance with IEC 60076-1:

1. Visual examination

2. Insulation resistance measurement
 3. Measurement of no load current
 4. Measurement of no load loss
 5. Measurement of resistance of the windings
 6. Measurement of percentage impedance voltages
 7. Measurement of load loss
 8. Polarity test
 9. Voltage ratio test.
 10. Dielectric tests comprising:
 - Separate-source voltage with stand test
 - Induced over voltage with stand test.
 11. Recording/ submission of SFRA as per IEC 60076.
 12. Recurrent Surge Oscillogram (RSO) Test
 13. Test for motorized off circuit tap changer
- 16.6.2 **Visual examination:** A general examination shall be made to check that the transformer conforms to the approved Drawings, various items are accessible for maintenance, the quality of workmanship and finish are of acceptable standards and all parts, fittings and accessories are provided.
- 16.6.3 **Insulation resistance test:** The Insulation resistance of the windings with respect to the earth and between the windings shall be measured using a 5 kV Megger.
- 16.6.4 **Measurement of no-load current:** Measurement of no load current referred to the primary side shall be done at:
1. 90%, 100% and 110% of the rated voltage at the principal tapping, and
 2. The appropriate tap voltage at the +10% and -15% tap positions.
- 16.6.5 **Measurement of no-load loss:** Measurement of no-load loss referred to the primary, side shall be done at:
1. 90%, 100% and 110% of the rated voltage at the principal tapping, and
 2. The appropriate tap voltage at the +10% and -15% tap positions.
- 16.6.6 **Measurement of resistance of windings:** The resistance of the windings shall be measured at all tappings and computed at 75⁰C.
- 16.6.7 **Measurement of percentage impedance voltages:** The percentage impedance voltages at 'principal', +10% tap and -15% tap positions shall be measured at rated current and at ambient temperature and computed at 75⁰C.
- 16.6.8 **Measurement of load loss:** Load losses at rated current shall be measured at principal, +10% and -15% tap positions at ambient temperature and computed at 75⁰C.
- 16.6.9 **Polarity test:** The polarity (subtractive) and marking of the terminals for the polarity shall be verified.
- 16.6.10 Voltage ratio test: Voltage ratio shall be measured at all tap positions.
- 16.6.11 Dielectric tests:

16.6.12 Induced over voltage withstand test: The test shall be done by applying the test voltage across the entire secondary winding as per IEC 60076-3.

16.6.13 Separate source voltage withstand test: The test voltage to be applied as under:

1	Highest voltage for equipment Um (kV)	52	245/145
2	Rated short duration power frequency withstand voltage (kV)	95	395/275

16.6.14 Recording of Surge Frequency Response Analysis (SFRA) as per IEC 60076-18. Tests on off-load tap-changer: The tests shall be conducted in accordance with IEC 60214.

16.6.15 During the routine tests of any unit if it is found that the sum of the measured losses (i.e. no-load and load losses) measured at the principal tapping (corrected to 750C) exceeds the maximum guaranteed value defined in Clause 5.1 (14), the transformer shall be rejected.

16.7 If the prototype of a transformer conforming to this document and rating has already been approved in connection with previous supplies to Indian Railways, fresh type testing may be waived at the discretion of the Employer, provided that no changes whatsoever in the design or materials used or the process of manufacture have been made.

However, the Employer reserves the right to conduct type tests, if he deems, it necessary to do so in the light of experience gained from previous supplies.

16.8 Only after approval of the original tracings of Drawings incorporating changes, if any, as a result of the prototype tests and clear written approval of the results of the tests on the prototype is communicated by the Employer, to the successful bidder/manufacturer, shall he take up bulk manufacture of the transformer which shall be strictly with the same materials and process of manufacture as adopted for the prototype. In no circumstances shall materials other than those approved in -the design/Drawings and/or during the prototype testing be used for bulk manufacture-on the plea that they had been obtained prior to the approval of the prototype.

16.9 The bidder may quote his charges for short-circuit and temperature rise tests. No charges shall be payable, for any other type and routine tests.

16.10 Transformer before dispatch should be filled with Nitrogen/ dry air and provided with a gauge clearly visible for monitoring the pressure inside the tank.

17 TECHNICAL DATA

The following shall be furnished by the Contractor:

17.1 Calculations for:

1. Temperature rise of winding at rated current.
2. Hot-spot temperature of the winding at 150% and 200% rated loads for 15 min and 5 min respectively.
3. Thermal withstand capacity of the windings for a short circuit of 2 s duration.
4. Mechanical forces in respect of the following as per IEEMA (Indian Electrical & Electronic Manufacturer's Association) formulae:
 - a) Asymmetrical short-circuit current.

- b) Hoop stress in primary and secondary windings.
- c) Compressive pressure in the radial spacers.
- d) Internal axial compressive force.
- e) Axial imbalance force.
- f) Radial bursting force.
- g) Resistance to collapse.
- h) Bending stress on clamping ring and densified wood.
- i) Maximum allowable torque on pressure screws for coil clamping bolts at the time of tightening, if any.

5. Flux density with the characteristic curve.

6. Maximum value of inrush current.

17.2 Drawings for:

1. Outline General Arrangement Drawing giving complete details of the transformer.
2. Arrangement of the core, windings and magnetic path.
3. Magnetizing characteristic of CRGO sheet steel.

17.3 The successful bidder/ manufacturer shall submit to Engineer for approval the following detailed dimensioned Drawings as per Indian Railways standard in sizes of 210 mm x 297 mm or any integral multiples thereof.

1. Outline general arrangement of the transformer indicating plan, front elevation, side elevation with all parts, fittings and accessories, electrical, clearances as well as salient guaranteed particulars.
2. Internal arrangement of the transformer indicating primary and secondary bushing lead connections, core to clamp to core-base bolting, and the locking arrangement of the core assembly with the tank.
3. Cross sectional view of the core and windings with material specifications and makes.
4. Detail of the pressure screws/oil dash-pot/coil clamping bolts or other devices and their location with materials specification.
5. Schematic view of the valves used on the transformer and the anti-theft device so as to prevent theft of oil.
6. Transport outlines dimensions.
7. General arrangements of the odd-circuit tap changer assembly with salient technical parameters.
8. Tap changer cubical layout.
9. Schematic diagram for driving of motorized off circuit tap changer via SCADA.
10. Name and rating plate of motorized off circuit tap changer.
11. General arrangement of marshaling box indicating protection and control equipment.
12. Wiring diagram of the marshaling box.

13. Schematic diagram of protection and control circuits in marshaling box with cable schedule.
 14. Legend plate showing protection and control circuits for fitment into the marshaling box.
 15. OIP condenser bushing for primary side including cross-sectional view, shed profile and salient electrical and mechanical characteristics.
 16. OIP condenser bushing for secondary side including cross-sectional view, shed profile and salient electrical and mechanical characteristics.
 17. Dimensional Drawing, V-I characteristic and rating plate for bushing type current transformers.
 18. Rigid terminal connectors for primary side bushing terminal
 19. Rigid terminal connectors for secondary side bushing terminal
 20. Rating plate with diagram of connections, both in English and Hindi versions.
 21. Details of radiators
 22. Details of breather
 23. External cable-run with cable schedule.
 24. Any other Drawings which the successful bidder considers necessary.
- 17.4** After approval, six copies of each of the approved Drawings along with two sets of reproducible prints for each Drawing shall be supplied to each consignee(s).
- 17.5** Two copies of the "Operations and Maintenance manual" for each transformer shall be supplied.
- 18 CAPITALIZATION OF TRANSFORMER LOSSES (NOT APPLICABLE)**
- 18.1 (Deleted).
- 19 SPARES**
- 19.1 The contractor shall supply spares for 220/132kV transformers listed below:
1. One primary bushing complete with parts, fitting and bushing type current transformer.
 2. One secondary bushing complete with parts, fitting and bushing type current transformer.
 3. One complete set of gaskets of all sizes required for use in the transformer.
 4. One breather unit with silica gel.
 5. One piece of radiator.
 6. One each of terminal connectors for primary and secondary side bushing terminals
 7. One set of valves
 8. One pressure relief device.
 9. One set of primary, secondary and tapping coil
 10. One complete off circuit motorized tap changer

20 ERECTION, TESTING AND COMMISSIONING

20.1 The transformer shall be erected and commissioned by the successful bidder. The manufacturer shall invariably make available at site the services of an engineer of his to ensure, by his continued presence, that the process of erection, testing and commissioning of the transformer is in accordance with established and recommended practices. For this purpose, prior intimation regarding the dates/period and locations at which the transformers are to be erected and testing/commissioning done shall be given by the bidder to the manufacturer.

21 SCHEDULE OF GUARANTEED PERFORMANCE, TECHNICAL AND OTHER PARTICULARS (GUARANTEED PARTICULARS ARE TO BE ESTABLISHED BY ACTUAL TESTS/ TEST REPORTS)

SN	DESCRIPTION	UNIT OF MEASUREMENT	VALUE/ INFORMATION
1	2	3	4
A	<u>RATINGS/PARTICULARS</u>		
1.	Name of the Manufacturer		
2.	Country of manufacture		
3.	Reference to specification based on which performance data is prescribed		
4.	Rated power	MVA	
5.	Primary current at:		
	a) Rated load	A	
	b) 150% rated load for 15 min	A	
	c) 200% rated load for 5 min	A	
6.	Secondary current at:		
	a) Rated load	A	
	b) 150% rated load for 15 min	A	
	c) 200% rated load for 5 min	A	
7.	Rated voltage :		
	a) Primary	kV	
	b) Secondary (at no-load)	kV	
8.	Rated frequency	Hz	
9.	Temperature rise above ambient temperature of 50 °C :		
	(i). Oil :		
	a) At rated load	°C	
	b) At 150% rated load for 15 min	°C	
	c) At 200% rated load for 5 min	°C	
	(ii) Winding :		
	a) At rated load °C		
	b) At 150% rated load for 15 min.	°C	
	c) At 200% rated load for 5 min	°C	
10	Hot-spot temperature of winding over ambient temperature of	°C	
	a) At rated load	°C	
	b) At 150% rated load for 15 min.	°C	

	c) At 200% rated load for 5 min	°C	
	Interval of time between two successive overloads after continuous working at full load, at maximum ambient temperature of 50°C:		
	a) Between two consecutive over min. loads of 50% for 15 min	min.	
	b) Between two consecutive min overloads of which one is of 50% for 15 min and the other of 100% for 5 min.	min.	
11	No-load current referred to primary side at rated frequency and at:		
	a) 90% rated voltage A		
	b) Rated voltage A		
	c) 110% rated voltage A		
12	Power factor of no-load current at rated voltage and rated frequency		
13	Value of the inrush current at rated voltage on primary side, the secondary side being open circuited		
14	Losses:		
	(i) No-load loss at rated frequency and at:		
	a) 90% rated voltage at the principal tapping.	kW	
	b) rated voltage at the principal tapping.	kW	
	c) 110% rated voltage at the primary tapping.	kW	
	(ii) Load loss (at 75 °C) at rated current and frequency	kW	
	a) Principal tapping	kW	
	b) -15% tapping	kW	
	c) +10% tapping	kW	
	(iii) Total losses at rated current and frequency		
	a) Principal tapping	kW	
	b) -15% tapping	kW	
	c) +10% tapping	kW	
15	Resistance voltage (at 75 °C) at rated current		
16	Reactance voltage (at 75 °C) at rated current and frequency		
17	Impedance voltage (at 75 °C) at rated current and frequency		
18	Resistance (at 75 °C) of primary winding		
19	Resistance (at 75 °C) of secondary winding		
20	Reactance of winding :		
	a) Primary at	H	
	a). Principal tapping	H	
	b). +10% tapping	H	
	c). -15% tapping	H	
	b) Secondary	H	
21	Regulation (at 75 °C) with rated current and at power factor of:		
	a) Unity	%	
	b) 0.8 lagging	%	
22	Efficiencies:		

	(i).	Efficiency (at 75 °C) at unity power factor at:	
	a).	100% load	%
	b).	75% load	%
	c).	50% load	%
	d).	25% load	%
	(ii).	Efficiency (at 75 °C) at 0.8 power factor lagging at:	
	a).	100% load	%
	b).	75% load	%
	c).	50% load	%
	d).	25% load	%
	(iii)	Percentage of rated load at which maximum efficiency occurs.	%
23		Ability to withstand short-circuit:	
	a).	Thermal	s
	b).	Dynamic	s
24		Thermal time constant (calculated):	
	(i)	for winding with respect to oil at:	
	a).	rated current	min
	b).	150% rated current	min
	c).	200% rated current	min
	(ii)	Complete transformer at rated current	min
25		Temperature gradient between oil and winding at:	
	a).	Rated current	°C
	b).	150% rated current for 15 min	°C
	c).	200% rated current for 5 min.	°C
26		Temperature rise of oil:	
	(i).	Calculated average temperature rise of oil at:	
	a).	Rated current	°C
	b).	150% rated current for 15 min	°C
	c).	200% rated current for 5 min	°C
	(ii)	Estimated temperature rise of top oil at:	
	a).	Rated current	°C
	b).	150% rated current for 15 min	°C
	c).	200% rated current for 5 min	°C
27		Details of core:	
	(i)	Type of core	
	(ii)	Flux density at rated voltage and frequency	tesla
	(iii)	Flux density at 110% rated voltage and frequency	tesla
	(iv)	Thickness of steel stampings	mm
	(v)	Grade of core material and conforming specification	
	(vi)	Exciting VA/kg for core stampings at:	

		a) Flux density of 1.70 tesla	VA/kg	
		b) Flux density at rated voltage	VA/kg	
		c) Flux density at 110% rated voltage	VA/kg	
	(vii)	Exciting VA/kg for assembled core at:		
		a) Flux density of 1.70 tesla	VA/kg	
		b) Flux density at rated voltage	VA/kg	
		c) Flux density at 110% rated voltage	Va/kg	
	(viii)	Type of Insulation between core laminations.		
	(ix)	Type of joint between the core limbs and yoke.	kV	
	(x)	Core bolt Insulation withstand voltage	kV	
	(xi)	Core bolt Insulation flashover voltage	kV	
		Details of windings:		
28	(i)	Type of winding		
		(a) Primary		
		(b) Secondary		
		(c) Number of turns of primary winding		
		(d) Number of turns of secondary winding		
		(e) Number of parallel paths in primary winding		
		(f) Number of parallel paths in secondary winding.		
		(g) Is interleaving/inter shielding of the winding adopted to ensure better impulse voltage distribution?	Yes/No	
		(i) Primary		
		(ii) Secondary		
		(h) Is the Insulation of end turns of winding reinforced?	Yes/No	
	(i)	Primary		
	(ii)	Secondary		
		(i) Type of coil		
	(ii)	Mode of connection (i.e. in series or in parallel) of the portions of the windings on the two limbs of the core, if applicable.		
	(iii)	Dimensions of the copper conductor used in the winding:		
		a) Primary	mm x mm	
		b) Secondary	mm x mm	
		c) Tapped winding.	mm x mm	
	(iv)	Current density at rated current.		
		a) Primary	A/mm ²	
		b) Secondary	A/mm ²	
	(v)	Insulation used over the conductor (details of material and specification there for)		
	(vi)	Type of joints, if any, in the windings		
	(vii)	Dielectric strength of windings:		
		a) Full wave lightning impulse withstand voltage:		
		i) Primary winding	kV peak	

	ii) Secondary winding.	kV peak	
	(b) Lightning Impulse chopped on the tail withstand voltage:	kV	
	(i) Primary winding		
	(ii) Secondary winding		
	(c) Separate source power frequency withstand voltage	kV	
	(i) Primary		
	(ii) Secondary		
	(d) Induced over voltage withstand value		
(viii)	Minimum flashover distance to earth in oil of :		
	a) Secondary winding to core		
	b) Primary winding to yoke		
	c) Primary winding to tank		
(ix)	Material used for coil clamping rings and specification there for		
(x)	Magnitude of axial pre-compressive force on the winding		
	(a) Primary	kV peak	
	(b) Secondary	kV peak	
(xi)	Calculated maximum axial thrust in the winding due to dead short circuit at the terminals		
	(a) Primary		
	(b) Secondary		
(xii)	Calculated short circuit forces:		
	a) Hoop stress in primary winding	kgf/cm ²	
	b) Hoop stress in secondary winding	kgf/cm ²	
	c) Compressive pressure in the radial spacers		
	d) Internal axial compressive force	kgf/cm	
	e) Axial imbalance force		
	f) Resistance to college	kgf	
	g) Bending stress on clamping	kgf/cm ²	
	h) Radial bursting force		
(xiii)	Arrangement to maintain constant pressure on the windings		
(xiv)	Maximum permissible torque on pressure screws for coil clamping at the time of tightening, if any.	N.m	
(xv)	Can either end of each secondary winding (25 kV) be connected directly to earth?	Yes/No.	
29	Motorised off-circuit tap changer:		
	a) Name of the manufacturer		
	b) Country of origin.		
	c) Type designation		
	d) Governing specification.		

	e) Is a separate taped winding provided on primary?		
	f) Number of tappings:		
	i) Plus tappings		
	ii) Minus tappings		
	g) Percentage variation of voltage on different tapping.		
	h) Minimum contact pressure between moving and stationery contacts	kgf	
	i) Maximum rated through current	A	
	j) Voltage class	kV	
	k) Rated voltage of control circuit	V(dc)	
	l) Tap changer motor particulars:		
	i) Make and type		
	ii) Rated voltage	V(dc)	
	iii) Rated current	A	
	iv) Rated power	kW	
	v) Speed	rpm.	
	vi) Class of Insulation		
30	Bushings:		
	(i). Primary side:		
	a) Name of the manufacturer		
	b) Country of origin		
	c) Governing specification		
	d) Type designation (specify as to whether it is OIP condenser bushing)		
	e) Voltage class	kV	
	f) Rated current	A	
	g) Visible power frequency discharge voltage	kV	
	h) Wet one minute power frequency withstand voltage	kV peak	
	i) Lightning impulse withstand voltage	mm	
	j) Creepage distance		
	k) Weight of assembled bushing	Kg	
	(ii) Secondary side		
	a) Name of the manufacturer		
	b) Country of origin		
	c) Governing specification		
	d) Type designation		
	e) Voltage class	kV	
	f) Rated current	A	
	g) Visible power frequency discharge voltage	kV	
	h) Wet one minute power frequency withstand voltage	kV	
	i) Lightning impulse withstand voltage	kV peak	
	j) Creepage distance	mm	

		k) Weight of assembled bushing	kgf	
31		Bushing type current transformers:		
	(i).	Primary side:		
		a) Name of the manufacturer		
		b) Governing specification		
		c) Transformation ratio		
		d) Accuracy class and rated accuracy limit factor		
		e) Rated current	A	
		f) Rated output	VA	
		g) Exciting current at the rated knee point emf	mA	
		h) Rated knee point emf	V	
		i) Secondary winding resistance corrected to 75 ⁰ C	ohm	
		j) Short time thermal current and duration.	kA, s	
	(ii)	Secondary side:		
		a) Name of the manufacturer		
		b) Governing specification		
		c) Transformation ration		
		d) Accuracy class		
		e) Rated current	A	
		f) Rated output	VA	
		g) Exciting current at the rated knee point emf	mA	
		h) Rated knee point emf	V	
		i) Secondary winding resistance corrected to 75 ⁰ C.	ohm	
		j) Short time thermal current and duration	kA, s	
32		Insulating oil :		
		a) Governing specification		
		b) Grade of oil		
		c) Source of supply		
		d) Specific resistance at:		
		i) 27 ⁰ C	ohm-cm	
		ii) 90 ⁰ C	ohm-cm	
		e) Dielectric, dissipation factor (tan-delta) at 90 ⁰ C		
		f) Dielectric strength	kV	
		g) Water content	ppm	
		h) Interfacial tension	N/m	
		i) Neutralization value	mg KOH/gm	
		j) Flash point	⁰ C	
33		Type of transformer tank		
34		Details of radiators:		
		a) Make and type		
		b) Type of mounting		
		c) Overall dimensions (LxWxH)	mmx mm x mm	

35		Details of Buchholz relay:		
		a) Make and type		
		b) Governing specification		
		c) Provision of shut-off valves on either side of the relay	Yes/No	
		d) Provision of alarm contact	Yes/No	
		e) Provision of trip contact	Yes/No	
		f) Rated current of contacts	A	
36		Details of winding temperature Indicator.		
		a) Make and type		
		b) Governing specification		
		c) Number of contacts provided		
		d) Rated current of contacts	A	
		e) Dielectric withstand value of contacts	kV	
37		Details of oil temperature indicator		
		a) make and type		
		b) Governing specification		
		c) Number of contacts provided		
		d) Rated current of contacts	A	
		e) Dielectric withstand value of contacts	kV	
38		Details of Magnetic oil level gauge:		
		a) Make and type		
		b) Governing specification		
		c) Diameter of dial mm		
		d) Number of contacts provided		
		e) Rated current of contact	A	
		f) Dielectric withstand value of contacts	kV	
39		Details of pressure relief device:		
		a) Make and type		
		b) Governing specification		
		c) Does it reset itself	Yes/No	
40		Bimetallic terminal connectors:		
	(i)	Primary side:		
		a) Source of supply		
		b) Governing specification		
		c) Type		
		d) Rated current	A	
		e) Temperature rise over an ambient temperature of 45°C while carrying rated current.	°C	
		f) Short time current and duration	kA, s	
	(ii)	Secondary side:		
		a) Source of supply		
	b) Governing specification			

	c) Type		
	d) Rated current	A	
	e) Temperature rise over an ambient temperature of 45°C while current rated current	°C	
	f) Short time current and duration	kA, s	
41	Acoustic sound level at a distance dB of 1 m, when energized at rated voltage and rated frequency without load.	dB	
42	Partial discharge value at 1.5Um/ 3 kV r.m.s.	pC	
43	Weights and dimensions:		
	(i) Net weight of core		
	(ii) Net weight of cooper:		
	a) Primary winding	kg	
	b) Secondary winding	kg	
	(iii) Net untanking weight of core frame and coils	kg	
	(iv) Net weight of insulating oil	kg	
	(v) Volume of insulating oil	l	
	(vi) Total weight of cooling equipment	t	
	(vii) Total weight of transformer without oil	t	
	(viii) Total shipping weight of complete transformer including all detachable parts, fittings and assemblies	t	
	(ix) Shipping weight of largest package	t	
	(x) Crane lift (excluding slings) for un-tanking core and coils	mm	
	(xi) Crane lift (excluding slings) for removal of primary side bushings.	mm	
	(xii) Dimensions of the complete transformer including all parts, fitting and accessories:		
	a) Overall length	mm	
	b) Overall breadth	mm	
	c) From rail level to the topmost point	mm	
	(xiii) Minimum thickness of steel plate/ sheet used:		
	a) Tank Cover mm		
	b) Tank bottom mm		
	c) Conservator mm		
	d) Radiator mm		
	e) Marshaling box. mm		
	(xiv) Overall shipping dimensions of the largest package (Length x width x height)	mm x mm x mm	
	(xv) Mode of transportation of transformer unit (filled with oil/nitrogen gas.)		
	Other particulars		
44	Is the transformer tank fitted with lifting pads? If yes, what is the number of pads	Yes/ No	

45	What is the number of inspection covers provided?		
46	Are comfits/ trays provided for cable run?	Yes/ No	
47	Is the core electrically connected with the tank?	Yes/No	
48	Will the gaskets to be used in the transformer give trouble free service for at least 7 years? If not, indicate the life.	Yes/No	
49	Is the core construction without core bolts?	Yes/No	
50	Are the core bolts grounded, and if so, how?	Yes/ No	
51	What is the number of radial spacers used in the winding?		
52	What is the number of joints provided in the winding?		
53	Are the spacers/blocks/angle rings of pre-compressed press boards? If no, indicate the material with specification.		
54	Are arrangements made for ensuring automatic constant pressure on the coils? If no. give the reasons.	Yes/ No	
55	Are closed slots provided on outer most winding for locking the vertical strips? If no, give the reason.	Yes/ No	
56	What is the periodicity for tightening of coil clamping arrangement?	Years	
57	What are the designed values of short-circuit current for:		
	a) Symmetrical :		
	i) Primary winding A		
	ii) Secondary winding A		
	b) A symmetrical:		
	i) Primary winding A		
	ii) Secondary winding A		
58	What is the over flux withstand capability of the transformer (Maximum permissible limit of flux density)?	Tesla	
59	Are windings pre-shrunk?	Yes/No	
60	Have the details of drying cycles of the coils/coil assembly including final tightening values of pressure, temperature and degree of vacuum at various stages of drying been furnished?	Yes/ No	
61	Are arcing horns provided for line and neutral bushings?	Yes/ No	
62	Is a test tap provided in the line bushing?	Yes/ No	
63	Is the porcelain housing of the bushings of single piece construction?	Yes/ No	
64	Is the shed profile of porcelain housing of the bushing free from under-ribs but has a lip?	Yes/ No	
65	Is the bushing type current transformer of low reactance type?	Yes/ No	
66	Is Clause by Clause "Statement of compliance" attached?	Yes/ No	
67	Does the tap changer have snap action? If not, give reason.		
68	Is the Buchholz relay provided with two shut-off	Yes/ No	

		valves, one on either side?		
69		Is separate conservator tank & Buchholz relay provided for tap changing equipment?	Yes/ No	
70		Are fasteners of 12 mm diameter and less exposed to atmosphere of stainless steel to Grade 04Cr17 Ni12Mo to IS 1570 Part-V?	Yes/ No	
71		Are the fasteners of more than 12 mm diameter exposed to atmosphere of stainless steel or MS hot dip galvanized?	Yes/ No	
72		Are test certificates for tests as per Clause 15.0 attached?	Yes/ No	
73		Are all the calculations required as per clause 16 enclosed?	Yes/ No	
74		Are all the Drawings required as per clause 16 attached?	Yes/ No	
75		(a) Are all the parts, fittings and accessories from RDSO's approved manufacturers?	Yes/ No	
		(b) If not, list the items which are to be type tested in the presence of Employer's Personnel.	Yes/No	
76		Is adequate space provided in the marshaling box for housing the wiring and components?	Yes/ No	

Annexure - I

TECHNICAL SPECIFICATIONS FOR NITROGEN INJECTION FIRE PREVENTION AND EXTINGUISHING SYSTEM FOR OIL FILLED TRANSFORMER

1.0 GENERAL DESCRIPTION

Nitrogen injection fire protection system designed for oil filled transformers shall prevent tank explosion and the fire during internal faults resulting in an arc, where tank explosion will normally take few seconds after arc generation and also extinguish the external oil fires on transformer top cover due to tank explosion and/or external failures like bushing fires, OLTC fires and fire from surrounding equipment's.

The system shall drain a pre-determined quantity of oil from the tank top through outlet valve to reduce the tank pressure and inject nitrogen gas at high pressure from the lower side of the tank through inlet valves to create stirring action and reduce the temperature of top oil surface below flash point to extinguish the fire.

Conservator tank oil shall be isolated during bushing bursting, tank explosion and oil fire to prevent aggravation of fire.

Transformer isolation shall be an essential pre-condition for activating the system. The system shall be designed to operate automatically. However, it shall be designed for manual operation, in case of failure of power supply.

The system shall consist of following equipment:

1. Fire extinguishing cubicle placed on a plinth at about 5-10 meter away from the transformer.
2. Control box placed in the control room.
3. Necessary valves in the conservator pipe.
4. Suitable fire sensing components to be provided preferably in/on the tank cover.
5. Signal box suitably placed.

2.0 SCOPE

The scope of this document covers design, engineering, supply testing at works before dispatch; erection, testing and commissioning and performance demonstration of "fire protection and extinguishing system by nitrogen injection method".

The necessary civil work which will be required for construction of oil soak – pit for the storage of oil coming out from the transformer and plinth for extinguishing cubicle is included in the scope of this work. Laying of oil pipe, nitrogen pipe, electrical cables, control boxes, extinguishing cubicle, nitrogen cylinder, necessary vales, fire detectors and other equipment & accessories required for erection, testing, commissioning and performance demonstration of the complete fire protection system is in the scope of the Tenderer. It will be the responsibility of the Tenderer, i.e. transformer manufacturer to coordinate with the supplier of the Fire Protection System for all the arrangements for the complete erection, testing, commissioning and performance tests. Notwithstanding the technical specifications and requirements mentioned herewith any modification can be incorporated for correct operation of nitrogen injection fire protection system without

extra cost. The full details of the same are required to be submitted to Employer for approval, when first unit is implemented on a transformer of specific make & rating.

3.0 OPERATIONAL CONTROLS

The system shall be provided with automatic control for fire prevention and fire extinction. Besides automatic control, remote electrical push button control on control box and local manual control in the fire-extinguishing cubicle shall be provided. The fire protection system will take signal from HV/LV circuit breaker.

4.0 SYSTEM ACTIVATING SIGNALS

4.1 Transformer isolation shall be an essential pre-condition for activating the system. Provision shall be provided to isolate the Traction Power Transformer through Master trip relay or circuit breaker (HV and LV side in series) before Nitrogen injection and after oil depressurization.

4.2 There shall be two modes of operation of Fire Protection System i.e. Fire Prevention Mode & Fire Extinction Mode. In these modes the safety equipment to be involved are tabulated below. The logic of their operation shall be finalized during design approval.

Mode of Operation	Safety Equipment to be used
Fire Prevention Mode	<ul style="list-style-type: none"> • Differential relay/Over current/Restricted earth fault relay. • Pressure relief valve
Fire Extinction Mode	<ul style="list-style-type: none"> • Fire sensing components • Buchhloz relay

5.0 SYSTEM EQUIPMENT

5.1 Fire Extinguishing Cubicle (FEC), placed on plinth at about minimum 5 meter away from the transformer shall consist of:

5.1.1 Nitrogen gas cylinder with pressure reducer/regulator and falling pressure electrical contact manometer.

5.1.2 Oil drain pipe with mechanical quick drain valve;

5.1.3 Electro mechanical control equipment for oil drain and pre-determined regulated nitrogen release.

5.1.4 Pressure monitoring switch for backup protection, pressure reducer with solenoid valve in the cabinet for operation of nitrogen gas release, which will be IP-65, protected and leak proof for nitrogen release.

5.1.5 Limit switches for monitoring of the system.

5.1.6 Flanges on top panel for connecting oil drain and nitrogen injection pipes for transformer.

5.1.7 Panel lighting

5.1.8 Oil drainpipe extension of suitable sizes for connecting pipes to oil pit.

5.1.9 The Nitrogen gas cylinder should be of sufficient (not less than 50 liter) capacity and should be filled at a pressure of not less than 150 bars with falling pressure electrical contact manometer, suitable design measures to prevent leakage of gas to be taken.

- 5.1.10 The nitrogen valve shall have IP-65 protection. The nitrogen shall be contained within the cylinder and released from the cylinder valve only upon activation of the fire protection system. Nitrogen purity shall 99.99%
- 5.1.11 Proper approvals and certificates should be provided with each cylinder. No used nitrogen bottle will be accepted.
- 5.2 Control box with activating, monitoring devices and line faults indicators to be placed in control room. It should have audio-visual alarm indication and push button switches for tests response.
- 5.3 Necessary valves to be fitted in the conservator pipeline between conservator and Buchholz relay operating mechanically on transformer oil flow rate with electrical signal for monitoring.
- 5.4 Suitable fire sensors to be fixed on transformer tank top cover and off circuit tap changer for sensing fire.
- 5.5 Signal box to be fixed on transformer side will for terminating cable connection from sensors and conservator shutter/signal box to be suitably placed.
- 5.6 All other consumables necessary for operation of complete system.
- 5.7 Control box should be microprocessor based and compatible to be interfaced with existing RTU for Railway Traction SCADA system available at the control room. For communication, Control box shall have provision for interfacing with SCADA in this regards details Digital Input & Output required for operation monitoring through SCADA should be furnished.

6.0 OTHER REQUIREMENTS FOR SYSTEM INSTALLATION

- 6.1 Oil drain and nitrogen injection openings with gate valves on transformer tank at suitable locations.
- 6.2 Flanges with dummy piece in conservator pipe between Buchholz relay and conservator tank for fixing.
- 6.3 Brackets on transformer top cover for sensing equipment, valves to enable operation of the system.
- 6.4 Spare potential free contacts for system activating signals i.e. differential relay, Buchholz relay, pressure relief valve, transformer isolation (master trip relay).
- 6.5 Pipe connections between transformer to fire extinguishing cubicle and fire extinguishing cubicle to oil pit.
- 6.6 Cabling on transformer top cover all sensors to be suitably connected for reliable fire sensing and inter cabling between signal box to control box and control box to fire extinguishing cubicle.
- 6.7 Plinth for fire extinguishing cubicle. Oil pit with capacity as 10% of total oil quantity of transformer.

7.0 TECHNICAL DETAILS

Fire extinction period:

- | | | |
|---|---|--------------------|
| On commencement of Nitrogen injection | : | Maximum 30 seconds |
| On system activation up to post cooling | : | Maximum 3 minutes |

Heat sensing area	: 140± 2°C
Seating for operation to isolate conservator	: Min.60Ltr. per minute

Power Source:

Control Box	: 110 V DC
-------------	------------

8.0 CABLING:

- 8.1 Fire survival cables, able to withstand 750°C, 1.5 mm² with necessary no. of conductors for connection of fire detectors in parallel shall be used. The test certificates for the cables shall be submitted.
- 8.2 Fire retardant low smoke (FRLS) cable 1.5 mm² with necessary no. of conductors for connection between transformer signal box/marshaling box to control box and control box to fire extinguishing cubicle shall be used.
- 8.3 Fire retardant low smoke (FRLS) cable 1.5 mm² with necessary no. of conductors for connection between control box to DC supply source and fire extinguishing cubicle to AC supply source, signal box/marshaling box to transformer shall be used.

9.0 PREVIOUS EXPERIENCE FOR QUALIFYING SUPPLIER

The supplier shall have a minimum experience of two years in the design, manufacturing, erection, testing and commissioning of Nitrogen Injection Fire Protection System on power transformers of similar or higher rating. At least 2 sets of the system shall be in successful operation for a minimum period of the 2 years. The supplier shall furnish the details of Nitrogen Injection Fire Protection System supplied by them so far, giving order reference, name and address of the customer, indicating the dates of commissioning as well as performance certificate of successful and satisfactory operation for minimum two years from the customers.

10.0 TESTS

10.1 Type Tests

Type test reports including that for detectors along with declared response time as per test approval certificate letter shall be submitted by the contractor.

The system shall be tested by international or a national testing body (NABL accredited recognized laboratory. Tariff Advisory Committee (TAC's) approval, if any, shall be submitted.

10.2 Factory Test

Tests will be carried out on individual equipment of the system and the total system in the supplier's workshop in presence of Employer's Personnel.

10.3 Performance Test

Performance test of the complete system shall be carried out after complete erection at site by the supplier's representative. These tests shall include simulation and verification of the response of the complete system without actual draining of the oil and injection of the nitrogen gas.

In addition to above, additional tests as required necessary shall be conducted.

11.0 DRAWINGS AND MANUALS

After awarding of contract, detailed dimensional Drawing of the system complete bill of materials including location and size of plinth for cubicle and recommended capacity of oil soak-pit shall be submitted for Engineer's approval. After approval 10 (ten) sets of all above Drawings and 5 (five) sets of operation and Maintenance Instruction Manual (bound) shall be submitted for Employer's use.

Appendix-9

SPECIFICATION FOR 8 MVA, 54 kV, 50Hz AUTO TRANSFORMER **FOR 2 X 25 kV AT FEEDING SYSTEM**

1 SCOPE

- 1.1 This document applies to 8 MVA, ONAN, 54 /27 kV Autotransformer for Auto Transformer (AT) feeding system for Installation in DFCC
- 1.2 The transformer shall be complete with all parts, fittings and accessories whether specifically mentioned herein or not, necessary for its efficient operation in an unattended traction substation.

2 GOVERNING SPECIFICATION

- 2.1 In the preparation of this document, assistance has been taken from the following National and International Standards, wherever applicable.

Table No.: 2.1-1

Standards		Description
Equivalentents	IS	
IEC 60076 (all parts)	IS:2026 (all parts)	Power transformers.
IEC 60044-1	IS:2705	Instrument transformer – Part 1: Current transformer.
IEC 60137	IS:2099	Bushing for alternating voltages above 1000V
IEC 60214	IS:8468	Tap changers.
IEC 60296	IS:335	Fluids for electro technical applications - Unused mineral insulating oils for transformers and switchgear/ New insulating oils.
	IS:5	Colors for ready mix paints and Enamels.
IEC 60502-1	IS:1554 (Part 1)	PVC insulated (heavy duty) Electric cables: Part 1 For working voltages up to and including 1100V
	IS:1570	Schedules for Wrought Steels - Part 5: Stainless and heat resisting steels.
	IS:1576	Solid pressboard for electrical purposes
IEC 60422	IS:1866	Code of practice for electrical maintenance and supervision of mineral insulating oil in equipment
	IS:2927	Brazing alloy
JIS C 2553	IS:3024	Grain orient electrical steel sheets and strips
	IS:3637	Gas operated relays
	IS:3639	Fittings and accessories for power transformers
	IS:4253	Cork composition sheets : Part 2 Cork and Rubber
	IS:5561	Electrical power connectors
	IS:5621	Hollow insulators for use in electrical equipment

IEC 60909	IS:13234	Guide for short circuit calculations in 3Phasea.c. systems.
IEC 60270	IS: 6209	High-voltage test techniques - Partial discharge measurements.
IEC 60076	IS:6600	Guide for loading of oil-immersed transformers
	IS:10028 (all parts)	Code of practice for selection, installation and maintenance of transformers
	IS:10593	Mineral Oil-impregnated electrical equipment in services - Guide to the interpretation of dissolved and free gases analysis
IEC 60137	IS: 12676	Oil impregnated paper insulated condensers bushings – dimensions and requirements
	DIN:7733	Laminated products, pressboard for electrical engineering, types
		Central Electricity Authority (Measures relating to Safety and Electricity Supply) Regulations, 2010, part-III, Sec.4, 2010 Rule no. 44 (2) (ix).

- 2.2 In case of any conflict between the contents of the above standards and this document the latter shall prevail.

3 CLIMATIC AND ATMOSPHERIC CONDITIONS

- 3.1 The transformer shall be suitable for outdoor use in moist tropical climate and in areas the limiting weather conditions which the equipment has to withstand in service are given in clause 4.2, Chapter- 4 of this Specification.
- 3.2 The transformer shall also be subjected to vibrations on account of trains running on nearby Railway tracks.

The amplitude of these vibrations which occur with rapidly varying time periods in the range of 15 to 70 ms lies in the range of 30 to 150 microns at present, with the instantaneous peaks going up to 350 microns. These vibrations may become more severe as the speeds and loads of trains increase in future.

4 TRACTION POWER SUPPLY SYSTEM (2x25 kV AT FEEDING SYSTEM)

4.1 General Scheme

- 4.1.1 The electric power for railway traction is supplied in ac 50 Hz, single-phase through 2x25 kV AT feeding system, which has a feeding voltage (2x25 kV) from the traction substation (TSS) two times as high as the catenary voltage, which is 25 kV with respect to earth/rail. The power fed from the TSS through catenary and feeder wire is stepped down to the catenary voltage by means of autotransformers (ATs) installed about every 13 to 17 km along the track, and then fed to the locomotives. In other words, both the catenary and feeder voltage are, 25 kV with respect to the earth/rail, although the substation feeding voltage between catenary and feeder wires is 50 kV. The catenary voltage is therefore, the same as that in the conventional 25 kV system.
- 4.1.2 The power supply shall be obtained from the 220/132 kV, three-phase, effectively earthed transmission network of the State Power to the Scott-connected transformer installed at the TSS, whose primary winding is connected to the three phases of the

transmission network. The spacing between adjacent substations is normally 60 km.

- 4.1.3 One outer terminal of the secondary windings of the traction transformer is connected to the catenary and the other outer terminals are connected to the feeder.
- 4.1.4 ATs connect the 25 kV catenary to 25 kV return feeder, with mid-point connected to rail and earth (25 kV return OHE and earth). Two adjacent AT's share power to feed trains at 25 kV/2x25 kV system feeds 50 kV supply from traction transformer terminal to the ATs. The load current (current drawn by electric locomotives) from the TSS flows through the catenary and returns to the TSS through the feeder. For a train in an AT-cell (distance between two consecutive ATs), most of the current is fed to the electric locomotive by the ATs of that AT-cell; the current returns in the rails/earth and is boosted up to the feeder through the neutral terminals of the autotransformers. The current in OHE, therefore, is an algebraic sum of 25 kV current feed to locomotives from AT and the 50 kV supply to ATs from the TSS.
- 4.1.5 Approximately midway between adjacent TSSs, a sectioning and paralleling post (SP) is provided. In order to prevent wrong phase coupling of power supply, a dead zone known as 'Neutral Section' is provided in the OHE opposite the TSS as well as SP. At the TSS, there are two-feeder circuit breakers for either side of the TSS for controlling the power fed to the OHE, in a double track section. Out of the two feeder circuit breakers for one side, one feeds the OHE of that side while the other remains (open) as standby. There is also a paralleling interrupter, which is normally closed, for either side of the TSS for paralleling the OHE of the UP and DOWN tracks. In case of fault in the OHE, the feeder circuit breaker of the TSS trips to isolate it. The Bridging Interrupter is used to feed one TSS up to the next TSS, in case the adjacent TSS is temporarily out of order.
- 4.1.6 For maintenance work and keeping the voltage drop within limit, one or more sub-sectioning and paralleling post (SSP) are provided between the TSS. The supply control Posts are on an average located every 13-17 km interval. An SSP has four sectioning interrupters and one paralleling interrupter, whereas an SP has two bridging circuit breakers (which remain open under normal feeding condition) and two paralleling interrupters.

4.2 Protection System

- 4.2.1 The Protection system of the traction transformer comprises the following:

1	Differential protection
2	Instantaneous and IDMT over-current, and earth fault protection on the primary side
3	Protection against phase-failure on the secondary side (i.e. to detect malfunction of feeder/transformer circuit breaker)
4	Buchholz Relay
5	Thermistor/Optical hot spot sensor. The Transformer should have built-in hottest spot temperature device to indicate and record the hot test spot temperature as per IEC-60076-2 (Ed. 3.0).

- 4.2.2 The protection system for the OHE comprises the following:

1	Distance protection
2	Delta I type fault selective protection
3	Instantaneous over current protection
4	Under-voltage protection to avoid wrong phase coupling
5	Fault locating expert system based on AT voltage neutral current.

4.3 OHE General data

4.3.1 The OHE shall consists of **(i)** Contact wire of minimum 150 mm² cross section suspended directly from catenary of wire of minimum 120 mm² cross section by a number of vertical dropper wires, usually at regular intervals and **(ii)** a feeder wire of stranded all aluminum conductor.

4.4 Auto Transformer General Data

4.4.1 The transformer shall have Minimum 8 MVA power rating based on ONAN cooling or higher as confirmed by simulation results. The Contractor shall develop the Technical Specifications for higher Capacity MVA Auto transformers based on this specification and get it approved from the Engineer.

4.5 Nature of traction loads and faults on the OHE system

4.5.1 The traction load is a frequently and rapidly varying one, between no load and overload. The TSS equipment is subject to frequent earth faults/short circuits caused by failure of Insulation, snapping of OHE touching earth, wire dropped by bird connecting the OHE to earth/ over line structure, and miscreant activity. On an average, the number of faults/ short circuits per month could be as high as 40. The magnitude of the fault current may vary between 40% and 100% of the dead short circuit value. These faults are cleared by the feeder circuit breaker on operation of the distance, delta I and instantaneous over-current relays associated with the concerned feeder circuit breaker. In 2x25 kV system faults can occur with: feeder-earth; feeder-OHE and OHE-earth faults or a combination of them.

4.5.2 The existing Indian Railways ac electric locomotives are silicon rectifiers, with dc motors or GTO/IGBT based power converter fed 3-phase Induction Motor and the average power factor generally varies between 0.7 and 0.85 lagging, without reactive power compensation, which introduces harmonic currents in the 25 kV power supply system.

4.5.3 On DFCC (Eastern) Locomotives are proposed to have VVVF drives and improved power factor closer to 0.98 and negligible harmonics. The traction supply may therefore be at higher power factor than those on IR.

4.6 Short-circuit apparent power of the system

4.6.1 The short-circuit apparent power at the transformer location for various system voltages is as under:

Highest system voltage (kV)	Short circuit apparent power, (MVA)
72.5	3,500
123	6,000
145	10,000
245	20,000

4.7 Auxiliary power supplies at TSS

4.7.1 The following auxiliary power supplies are available

1	110V dc from a battery
2	240 V ac, 50 Hz, single-phase from a 25/0.24 kV auxiliary transformer feed from Traction supply.

5 RATING AND GENERAL DATA

5.1 The rating and general data of the auto transformer shall be as follows:

SN	Item	Description
1.	Type	ONAN cooled, single-phase autotransformer with Centre tapping (neutral terminal), double limb wound, core-type for outdoor installation
2.	Winding	One winding with Centre tapping, uniformly insulated, shall be provided. The outer (line) terminals of the winding shall be brought out through 54 kV class bushings, whereas the neutral terminal (Centre tapping) through 12 kV class bushing.
3.	Rated frequency, Hz	50 \pm 3%
4.	Rated primary voltage, kV	54
5.	Maximum primary voltage, kV	60
6.	Rated secondary voltage (at no-load), kV	27
7.	Rated power, MVA	8 MVA ONAN
8.	Rated current	
	1) Rated primary current, A	148
	2) Rated secondary current, A	296
9.	Maximum leakage impedance as seen from secondary side	0.45 ohm
10.	Non-cumulative overload capacity after the transformer has reached steady temperature on continuous operation at rated load (i.e.at rated power)	150% rated load for 15 min 200% rated load for 5 min
11.	Temperature rise	1. Winding: 50K at rated load, and 60K for overloads as specified in Clause 5.1(10) (Temperature measured by resistance method). 2. Top oil: 45K (temperature rise measured by thermometer) 3. Current carrying parts in air: 40K (temperature rise measured by thermometer).
12.	Maximum permissible losses	
	1. No-load loss, kW as per IEC 60076-1 clause 3.6.1	7.5 kW
	2. Load loss, kW as per IEC 60076-1 clause 3.6.3	26.5 kW
	3.Total losses as per IEC 60076-1 clause 3.6.4	34 kW
13.	Short circuit current (symmetrical)	25 (Twenty five) or 35 (Thirty five) times of the rated current.
14.	Ability to withstand short circuit current of 25 (Twenty five) or 35 (Thirty five) times	

	of the rated current			
	1. Thermal ability	5s		
	2. Dynamic ability	0.5s		
15.	Flux density at rated voltage and frequency	Shall not exceed 1.55 Tesla.		
16.	Current density in the windings at rated current	Shall not exceed 2.5 A/mm ²		
17.	Acoustic sound level when energized	NEMA Standard TR-1-1993 (R2000) Table - 2		
18.	Bushings	Item	Line terminals	Neutral terminals
		Type	OIP condenser	Solid or Liquid filled porcelain
		Highest voltage for equipment Um(kV)	52	12
		Rated current(kV)	800	800
		Minimum Creepage distance in air(mm)	1300	300
19.	Bushing type current transformers on neutral transformer for fault locator:			
	1. Highest voltage for equipment Um, kV	12		
	2. CT ratio	500/5		
	3. Frequency, Hz	50 ± 3%		
	4. Rated output, accuracy class and accuracy limit factor as per IEC60044-1	30VA Class 5P15		
	5. Minimum knee-point emf, V	125		
	6. Maximum excitation current at knee-point voltage, A.	0.25		
	7. Maximum resistance of the secondary winding When corrected to 75 °C, ohm	0.25		
	8. Rated short-time thermal current	25 kA for one second		
9. Rated dynamic current	62.5 kA (peak)			

6 SALIENT DESIGN FEATURES

6.1 Overall Dimensions

6.1.1 The overall dimensions of the transformer shall be kept as low as possible and in any case shall not exceed the transportation limit.

(Transportation dimension)

1	Length x Width (in mm)	14,000 x 6,500
2	Height of topmost point of primary bushing terminal	7,500 mm
3	Height of topmost point of secondary bushing terminal	5,500mm

6.1.2 The manufacture shall, where practical, design the transformer so that with the bushings & accessories removed, the transformer shall fit within Indian Railway loading gauge, in case it is transported through rail, MMD to be enclosed with the offer.

6.1.3 The transformer should be designed nitrogen filled or dry air, such that it can be transported without the Insulation oil inside the tank. The transformer shall be designed such that it can be transported with tank under pressure with nitrogen and other protective measures that the Manufacturer recommends, so that no moisture can enters the housing.

6.2 Tank

6.2.1 The tank for the transformer shall be of the top cover jointed with bolted connection. The bottom plate of main tank shall be firmly welded to the main body and the top cover is a plate reinforced with ribs. This is subject to quality and life of windings which does not require any retightening after energized in field. A pressure gauge along with a hygrometer shall be provided so that the status of dryness of the winding can be assessed in the transformer prior to its heat run before commissioning.

6.2.2 The tank shall be constructed from mild steel of a quality that- allows welding without any defect/ flaw, with a single tier construction, so shaped as to reduce welding to the minimum. The welded joints shall be made using the latest welding techniques. The tank shall be adequately strengthened for general rigidity to permit hoisting of the transformer filled with oil by crane. The tank body shall be designed to withstand full vacuum degree.

6.2.3 The tank shall be fitted with four lifting pads at the lower end to enable lifting of the transformer filled with oil by means of lifting jacks.

6.2.4 The tank shall be fitted with an under carriage and mounted on bidirectional swiveling type flanged rollers for being rolled on 1676mm (5'6") gauge track on which it shall also rest in the final position. The rollers shall be provided with detachable type locking arrangement to enable their locking after installing the transformer in the final position, to hold the transformer fixed on foundation and to prevent any accidental movement of the transformer.

6.2.5 There shall be at least three inspection covers of suitable size on the tank to enable inspection of the lower portions of bushings, and the leads as well as the various connections inside the tank.

6.2.6 The gaskets with groove NBR (NITRILE BUTADIENE RUBBER) shall be provided for oil sealing points. The rubberized cork gasket may be used for other general portion.

6.2.7 All valves used in the transformer shall be capable to withstand full vacuum degree, conform to IS-3639. The manufacturer shall ensure that suitable anti-theft measures like locked use of blanking plates are provided on these valves, so as to prevent theft of oil during transit and service.

6.3 Marshaling Box

6.3.1 A vermin proof, weatherproof and well ventilated, marshaling box with IP class 55, made up of sheet steel of thickness not less than 2 mm, strengthened with adequate stiffeners, shall be provided on the left hand side of the transformer tank as viewed from the secondary terminals side. It shall have a hinged door, with provision for padlocking the door opening outward horizontally.

6.3.2 The marshaling box shall have a sloping roof. The top of the marshaling, box shall be at a height of about 2m from the transformer rail level.

- 6.3.3 The marshaling box, shall house the winding and oil temperature indicators and terminal board. To prevent condensation of moisture in the marshaling box, metal clad space heater controlled by an associated thermostat and switch shall be provided. Cable glands shall be provided for the incoming and outgoing cables.
- 6.3.4 The temperature indicators shall be so mounted such that their dials are at a height of not more than 1.6 m from the rail level. Transparent windows of tough acrylic plastic or similar non-fragile transparent material shall be provided on the marshaling box, so as to enable reading of the temperature indicators without opening the door of the marshaling box.
- 6.3.5 All cables from the bushing current transformers, magnetic oil level gauge, pressure relief device and temperature indicators shall be run up to the marshaling box. The cables shall be of 1100 V grade, XLPE insulated, XLPE sheathed, steel wire armored, stranded copper conductor conforming to IEC 60502-1. The cables shall be adequately insulated for heat from the tank surface and the sun.
- 6.3.6 All wiring in the marshaling box shall be clearly identified by lettered/figured ferrules of the interlock type, preferably of yellow colour with-black letters/figures. The ac and dc circuits shall be clearly distinguished and well separated from each other.
- 6.3.7 Suitable legend and schematic diagram plates made of anodized aluminum with black lettering and lines shall be fixed on the inside surface of the marshaling box door.

6.4 Core

- 6.4.1 The core shall be built-up of high permeability cold rolled grain oriented silicon steel laminations conforming to JISC 2553 or equivalent IS as indicated in Table No. 2.1-1. The flux density in any part of the core and yokes with primary winding excited at the rated primary voltage and frequency; shall not exceed 1.55T. The successful bidder / manufacturer shall furnish calculations to prove that this value shall not be exceeded.
- 6.4.2 The lamination for the core shall be free from waves, deformations and signs of rust. Both sides of the laminations shall be coated with suitable Insulation capable of withstanding stress relief annealing. In assembling the core, air gaps shall be avoided. Necessary cooling ducts shall be provided in the core and yoke for heat dissipation The core clamping frame shall be provided with lifting eyes for the purpose of tanking and un-tanking the core and winding of the transformer.
- 6.4.3 The core shall be electrically solidly connected to the tank.
- 6.4.4 Design of the Core shall be boltless and it shall be tightened by binding the laminations using resin glass type. Core laminations shall be tested after completion of the core assembly to ensure that they withstand a voltage of 2 kV r.m.s with respect to core for duration of 60 seconds.
- 6.4.5 The transformer is required to be continuously in service, preferably without requiring any attention from the date of its Energisation, up to the periodical overhaul (POH), which is generally done after 10-12 years of service. The successful bidder/ manufacturer of the transformer shall take this aspect into account during core assembly/manufacture and indicate measures taken by them to ensure suitable clamping to permit the above frequency and cover this in their instruction manual.

6.5 Winding

- 6.5.1 The winding shall be of disc/concentric/interleave/multilayer type. The winding shall be uniformly insulated. The two outer terminals of the winding shall be brought out through 54 kV OIP condenser bushings whereas the neutral terminal (Centre tapping) through a

12 kV oil-filled porcelain bushing. The QAP of the manufacturing process is to be submitted along with the bid.

6.5.2 The winding shall be made of continuous electrolytic copper conductor, paper insulated to class-A Insulation. The conductor shall not have sharp edges which may damage the Insulation.

6.5.3 The workmanship shall be of high quality in keeping with Good Engineering Practices.

6.5.4 No joint shall be used in the winding conductor, in principle, except for inter-leave joint.

6.5.5 The transformer winding shall be designed for the following rated withstand voltages:

1	Rated short duration power frequency withstands voltage kV	95
2	Rated lightning impulse withstand voltage kV peak	250

6.5.6 The axial pre-compression on the winding shall preferably be double the calculated axial thrust that may be set up under dead short-circuit condition, so as to ensure that the winding do not become loose due to frequent short circuits in service.

6.5.7 During short circuits the stresses set up in conductors, spacers and blocks, clamping rings and such other parts of the transformer, shall not exceed one third of the maximum permissible values.

6.5.8 Pre-compressed spacers shall be used between disc shaped coils of the winding to transmit the axial forces generated due to the short circuits.

6.5.9 Wood Insulation, if used on the core and winding shall be seasoned, dried and well compressed and shall have adequate strength.

6.5.10 A uniform shrinkage shall be ensured during the drying of the individual coils or assembly of coils by providing a uniform clamping force with the help of hydraulic jacks or similar devices.

6.5.11 The separate winding compression structure shall be provided apart from the core clamping structure in order not causing any loose. The equal-axial force and continuous compression system shall be applied onto each assembled windings throughout the drying process and fixed with the high-tension, self-tightening structure to eliminate any loose, unbalanced force due to non-uniform shrinkage of windings. No re-tightening of winding after the production is prohibited.

6.5.12 The successful bidder / manufacturer shall furnish details of various stages of drying of coils, coil assembly up to and including oil impregnation and final tightening of the coil assembly, values of pressure, duration, temperature and degree of vacuum maintained at various stages of drying shall also be indicated.

6.5.13 To prevent displacement of the radial spacers used in the winding, closed slots shall be provided and a vertical locking strip shall be passed through these slots.

6.5.14 The vertical locking strips and slots of the radial spacers shall be so designed as to withstand the forces generated due to short circuits.

6.5.15 The vertical locking strips and radial spacers shall be made of pre-compressed pressboard conforming to grade PSP: 3052 of DIN 7733.

6.5.16 To prevent end blocks from shifting, pre-compressed pressboard ring shall be provided in between the two adjacent blocks. Coil clamping rings made of densified wood or mild steel shall be located in position with pressure screws.

6.5.17 Leads from the winding to the terminals and other interconnections shall be properly supported and secured.

- 6.5.18 The following particulars / documents in respect of the radial spacer blocks (winding blocks), vertical locking strips (axial ribs), end blocks, insulating cylinder, angle rings, paper Insulation of the conductor and coil clamping plates used in the manufacture of winding shall be furnished:
- a) Reference to specification and grade of material.
 - b) Source(s) of supply.
 - c) Test certificates.

7 INSULATING OIL

- 7.1 The transformer shall be supplied with new inhibited mineral insulating oil conforming to IS12463. In addition, 10% extra oil by volume, shall be supplied in nonreturnable steel drums. The characteristics of the insulating oil before Energisation of service shall conform to IS1866.

8 BUSHINGS AND TERMINAL CONNECTORS

- 8.1 Both the line and neutral bushings shall confirm to IEC 60137. On the line side, 54 kV class, sealed solid stem type Oil Impregnated Paper (OIP) condenser bushings shall be used. On the neutral side, 12 kV class oil-filled porcelain bushing shall be used. The dimensions of the bushings shall confirm to IEC 60137.
- 8.2 The OIP condenser bushings shall have a non-breathing oil expansion chamber. The expansion chamber shall be provided with an oil-level indicator, which shall be so designed and dimensioned that oil level is clearly visible from ground level. A test tap shall be provided for dielectric or power factor measurement.
- 8.3 The bushings shall be designed for the following Insulation level:

1	Highest voltage for equipment U_m , kV	52	12
2	Rated short duration wet power frequency withstand voltage, kV	95	28
3	Rated lightning impulse withstand voltage, kV peak	250	75

- 8.4 The design and construction of the bushing shall be such that stresses due to expansion and construction in any part of the bushings shall not lead to its deterioration / breakage. The bushings shall be free from corona and shall not cause radio interference.
- 8.4.1 Adjustable arcing horns shall be provided on both the line and neutral bushings. The horn gap setting shall be variable as indicated below:

1	Highest voltage for equipment U_m , kV	52	12
2	Horn gap setting variable between, mm	150 & 500	60 & 100

- 8.5 The bushing terminals shall be provided with rigid type terminal connectors of bimetallic type and shall be such that there is no hot spot formation even during the extreme over load condition of ONAN rating with 200% over loading.
- 8.6 The terminal connectors shall confirm to IS: 5561. The design shall as to be connected to the equipment terminal stud with a minimum of four 12 mm diameter bolts, nuts, spring and flat washers.

9 BUSHING TYPE CURRENT TRANSFORMERS

- 9.1 The neutral bushing shall be so arranged as to accommodate bushing type current transformer (BCT) for connection to the AT neutral current ratio type fault locator as required as per the design. The BCT shall conform to IEC 60044-1 and meet with the stipulations in Clause 5.1(19) of this document.
- 9.2 The BCT shall be so designed as to withstand thermal and technical stresses resulting from frequent short circuits experienced by the transformer on which these are fitted.
- 9.3 Apart from the BCTs required for the biased differential protection, BCT of accuracy class 5 and conforming to IEC 60044-1, with suitable tapplings, shall be mounted inside a line bushing for use with the winding temperature indicator.
- 9.4 The BCTs and the bushings shall be so mounted that removal of a bushing can be achieved without disturbing the current transformers, terminals and connections or pipe work is easy and convenient.
- 9.5 The leads from the BCTs shall be terminated in terminal boxes provided on the bushing turrets. Suitable links shall be provided in the terminal boxes for shorting the secondary terminals of the BCTs, when not connected to the external measuring circuits.
- 9.6 The leads from the secondary winding of the BCTs terminated in the terminal box on the bushing turret up to the marshaling box shall be of 1100V grade PVC insulated PVC sheathed, steel wire armored, stranded copper cable of cross-section not less than 4 mm² to IEC 60502-1.
- 9.7 Cable glands of proper size shall be provided in the terminal boxes to lead in / lead out the cables.

10 CLEARANCES

- 10.1 The relative orientation in space of the bushings fitted with terminal connectors, the main tank radiators, conservator, pressure relief device, oil piping and other parts when mounted on the transformer, shall be such that the various clearances in air from live parts of bushing shall not be less than the appropriate values given hereunder:

1	Highest voltage for equipment Um, kV	52	12
2	Minimum clearance, mm	500	200

The same distance shall apply for clearance of phase-to-earth (including oil piping work, conservator, pressure relief device and such other parts), phase-to-phase and towards terminals of a lower voltage winding.

11 COOLING EQUIPMENT

- 11.1 The transformer shall be designed for ONAN type of cooling.
- 11.2 The radiators shall consist of a pressed steel plate assembly formed into elliptical oil channels or a series of separate elliptical tubes. The radiators shall be designed in such a manner that the temperature-rise limits specified under Clause 5.1(11) of this document are not exceeded.
- 11.3 The radiators shall be removable (after isolating the same from the main tank) to facilitate transportation of the transformer. A drain plug of size 19 mm and an air-release plug of size 19 mm shall be provided at the bottom and at the top of each radiator bank for draining and filling of oil respectively. Each radiator bank shall also be provided with shut-off valves. If radiators are supplied as a separate unit then body bellows type flexible joints shall be provided on the oil headers.

- 11.4 The radiators shall preferably be supported directly on the transformer tank. Each radiator bank shall be fitted with lifting lugs.

12 PARTS, FITTINGS AND ACCESSORIES

- 12.1 Apart from the parts, fittings and accessories specifically detailed in the foregoing Clauses, the parts, fittings and accessories detailed hereunder shall be supplied with each transformer:

- 12.1.1 **Oil level gauge:** It shall be of magnetic type having a dial diameter of 200 to 250 mm. The gauge shall have markings corresponding to minimum oil level, maximum oil level and oil level corresponding to oil temperature of 30⁰C, 45⁰C and 85⁰C. The oil level indicator shall be so designed and mounted that the oil level is clearly visible to an operator standing on the ground. The oil level gauge shall be fitted with two SCADA readable contacts. The first contact shall provide a warning that the oil level is at 25% above the minimum level. The second contact shall indicate when the minimum oil level has been reached.

- 12.1.2 **Silica Gel Breather:** Auto-transformers shall be provided with Silica Gel Breather or N2 filled without Silica Gel Breather (in case of non-breathing design). If Silica Gel breather is provided; it shall be complete with oil seal and connecting pipes. The connecting pipes shall be secured properly. The container of the silica gel breather shall be of transparent flexi glass or similar material suitable for outdoor application.

- 12.1.2.1 Orange silica gel (round balls 2 to 5 mm) with quantity of two DT-8 silica gel connecting with flanged mounting two pipes control through different valves as per DIN: 42567 & IS: 6401 to be provided.

- 12.1.3 **Pressure relief device:** It shall be designed to operate to release internal pressure at preset value without and endangering the equipment is operator and shall be of instantaneous reset type.

- 12.1.3.1 Shroud Pressure Relief Device will be used and have provision of discharge of oil from PRD to safe place by closed pipeline to avoid hazards of fire.

- 12.1.4 **Filter valves:** The bottom and upper filter valves shall be of 50 mm size and suitably baffled to reduce aeration of oil. The valves shall be flanged to seat 40 mm adopter threaded to thread size P 1½ for connection to oil filtration plant.

- 12.1.5 **Drain valve:** It shall be of size 80 mm fitted with an oil sampling device of size 15 mm.

- 12.1.6 **Earthing terminals:** Two earthing terminals of adequate size shall be provided on the tank for its earthing with the help of 3 mild steel flats, each of size 50 mm x 6 mm. The terminals shall be clearly marked for earthing.

- 12.1.7 **Oil temperature indicator (OTI):** It shall have one alarm contact, one trip contact and two normally open spare contacts none of the contacts being earthed. The contacts shall be electrically independent.

- 12.1.8 **Winding temperature indicator (WTI):** It shall have one alarm contact, one trip contact and two normally open spare contacts, none of the contacts being earthed. The contacts shall be electrically independent. The windings shall also be fitted with analogue temperature sensors/thermistors/optical sensors that are suitable for being remote read via the SCADA system.

- 12.1.9 **Thermometer pockets:** A separate thermometer pocket with cap shall be provided on the tank for measuring the top oil temperature in the tank. The thermometer shall indicate hot spot temperature.

12.1.10 **Rating plate:** The rating plate shall indicate the following:

- The ratings of the transformer
- The connection diagram of the windings
- The particulars of the bushing current transformers
- Weight without oil
- Weight with oil
- Kind of transformer (I.e. Scott Connected traction transformer)
- Manufacturer
- Date of manufacture
- Serial number
- Rated Voltages in (kV) and tapping range
- Rated primary and secondary currents
- Short circuit impedance
- Type of cooling

Other details as per IEC 60076-1. The rating plate shall be both in English and Hindi version.

12.2 All valves shall be of the double flange type and fitted with suitable blanking plates on the outer face of the exposed flange.

12.3 The capillary tubes for temperature indicators shall be able to withstand normal bending. They shall be supported properly without sharp or repeated bends or twists.

13 FASTENERS

13.1 All fasteners of 12 mm diameter and less exposed to atmosphere shall be of stainless steel and those above 12 mm diameter shall preferably be of stainless steel or of mild steel hot dip galvanized to 610 g/m² of zinc. The material of the stainless steel fasteners shall conform to IS: 1570 (Part-V) Grade O4Cr17Ni12Mo22 or equivalents.

14 PAINTING

14.1 Shot blasting / sand blasting shall be done on the transformer tank to remove all scales, rust and other residue, before applying the paint inside the tank. All steel surfaces which are in contact with insulating varnish. All steel surfaces exposed to weather shall be given, one primer coat of zinc chromate and two coats of grey anti-corrosion paint. The touch-up of grey paint shall be applied at site by, the manufacturer.

15 TESTING OF TRANSFORMER

15.1 General

15.1.1 The designs and Drawings together with the Quality Assurance Plan (QAP) shall be furnished to the Engineer, within the period stipulated in the contract.

Only after all the designs and Drawings as well as the QAP have been approved for prototype tests and a written advice given to that effect shall the successful bidder / manufacturer take up manufacture of the prototype of the transformer. It is to be clearly understood that any change or modification required by the above authorities to be done

in the prototype shall be done expeditiously, notwithstanding approval having already been given for the designs and Drawings.

15.1.2 Prior to giving a call to the Engineer for inspection and testing of the prototype, the successful bidder/ manufacturer shall submit diagrams for each of the tests and the number of days required to complete all the tests at one stretch. Once the schedule is approved, the tests shall invariably be done accordingly. In case any dispute or disagreement arises between the successful bidder/manufacturer and representative of the Engineer during the process of testing as regards the procedure for type tests and/or the interpretation and acceptability of the results of type tests, it shall be brought to the notice of the Employer, as the case may be, whose decision shall be final and binding. Only after the prototype transformer is completed and ready in each and every respect, shall the successful bidder/manufacturer give the actual call for inspection and testing.

15.1.3 The type tests shall be carried out on the prototype transformer at the works of the successful bidder/manufacturer or at a reputed testing laboratory in the presence of the representative of the Engineer in accordance with the relevant specifications and as modified or amplified by this document.

15.2 Tests During Manufacture

15.2.1 Though the test described below shall form part of the type tests, the manufacturer shall carry out these tests on first and every unit during the process of manufacture and submit the test reports to the Engineer deputed for witnessing the routine tests:

- a) Oil leakage test.
- b) Vacuum test.
- c) Pressure test.
- d) Test for pressure relief devise.
- e) Measurement of capacitance and tan-delta values.

15.2.1.1 **Oil leakage test:** The transformer with its radiators, conservator tank and other parts, fittings and accessories completely assembled shall be tested for oil leakage by being filled with oil conforming to IEC 60296 at the ambient temperature and subjected to a pressure corresponding to twice the normal static oil head or to the normal static oil head plus 35 kN/m² (0.35 kgf/cm²), whichever is lower, the static oil head being measured at the base of the tank. This pressure shall be maintained for a period of not less than 12 h, during which time no leakage shall occur.

15.2.1.2 **Vacuum test:** The transformer tank only shall be tested at a vacuum of 3.33 kN/m² (0.0333 kgf/cm²) for 60 min. The permanent deflection of flat plates after release of vacuum shall not exceed the values specified below:

Horizontal length of flat plate	Permanent deflection. mm
up to and including 750 mm	5.0
751 mm to 1250 mm	6.5
1251 mm to 1750 mm	8.0
1751 mm to 2000 mm	9.5
2001 mm to 2250 mm	11.0
2251 mm to 2500 mm	12.5
2501 mm to 3000 mm	16.0
above 3000 mm	19.0

15.2.1.3 **Pressure test:** Every transformer tank, radiator and conservator tank shall be

subjected to an air pressure corresponding to twice the normal static head of oil or to the normal static oil head pressure plus 35 kN/m² (0.35 kgf/cm²), whichever is lower, as measured at the base of the tank. The pressure shall remain constant do 1 hour to indicate that there is no leakage.

15.2.1.4 **Test for pressure relief devise:** Every pressure relief device shall be subjected to gradually increasing oil pressure. It shall operate before the pressure reaches the test pressure specified in Clause 15.2.1.3 hereof and the value at which it has operated shall be recorded.

15.2.1.5 **Measurement of capacitance and tan-delta values:** The measurement of capacitance and tan-delta (dielectric loss factor) of the transformer windings shall be made by Schering Bridge.

15.3 Type Tests

15.3.1 The type tests shall be carried out on the prototype transformer at the works of the successful bidder/manufacturer or at any reputed laboratory in the presence of the representative of the Engineer and in accordance with the relevant specifications and as altered, amended or supplemented by this document. Amongst others, following shall constitute the type tests:

1. Temperature-rise test.
2. Lightning impulse test.
3. Test with lightning impulse, chopped on the tail.
4. Short-circuit test.
5. Measurement of acoustic sound level.
6. Measurement of partial discharge quantity.
7. Measurement of harmonics of no-load current.

15.3.2 Temperature-Rise Test

15.3.2.1 The temperature-rise test shall be done in accordance IEC 60076-2 except as modified hereunder.

1	At rated load
2	At 150% rated load for 15min after continuous operation at rated load for 1hr.
3	At 200% rated load for 5min after continuous operation at rated load for 1hr.

The tests shall be done continuously without any power supply interruption. In case interruptions of power supply to take place for some reason, then the entire rest shall be repeated after steady state condition are attained.

15.3.2.2 The points to be ensured during the temperature-rise test shall be:

1	The ambient temperature shall be measured using calibrated thermometers only
2	The winding temperature shall be determined by the resistance method only.
3	The temperature of the top oil shall be measured calibrated thermometer placed in an oil-filled thermometer pocket.
4	The average oil temperature shall be calculated as the difference between the top oil temperature and half the temperature drop in the cooling equipment (radiators)
5	The temperature of the hot-spot in the winding shall be the sum of the temperature of the top oil and 'H' times the temperature rise of the winding

	above the average oil temperature, where 'H' is the hot spot factor as per IEC 60076-2 and 60076-7.
--	---

15.3.2.3 The test shall be carried out as described below:

15.3.2.3.1 **100% load**

1	A quantum of power equal to the sum of the measured losses viz. no-load and load losses corrected to 75 ^o C plus 10% of such sum shall be fed to primary winding of the transformer with the secondary winding short-circuited.
2	The power so fed to the transformer shall be continuously maintained till such time as the steady state temperature is reached i.e. the top oil temperature rise does not vary by more than 1 ^o C during four consecutive hourly readings
3	On attaining the steady state temperature, the current in the primary winding of the transformer shall be brought to the rated current which shall be maintained for 1 hour. At the end of the period the power supply to the transformer shall be switched off and the time of Switching off recorded
4	The measurement of hot resistance shall commence as soon as is possible after switching off. The first reading of the resistance shall be taken as soon as possible, before expiry of 90 seconds from the instant of switching off and the first ten readings shall be taken at intervals of 15s apart. Thereafter, another ten readings shall be taken at intervals of 30s apart.
5	The time at which each of the resistance values is read shall also be recorded.
6	The temperatures of the ambient, top oil, the top and bottom radiator header oils shall also be recorded at half-hourly intervals throughout the test starting from the instant power supply is; switched on to commence the if test till it is switched off.
7	The WTI and OTI readings shall also be recorded at half hourly intervals right from the instant the power supply is switched on to commence the test till it is switched off
8	After power supply is switched off the readings of OTI and WTI shall be recorded at intervals of 1 min apart for 30 min

15.3.2.3.2 **150% load**

1	After completion, of the test at 100% load, the transformer shall be fed with power which shall be a value so as to cause circulation of the rated current in the primary winding with secondary windings short circuited. This current shall be circulated for 1 hour.
2	The current shall thereafter be increased to 150% of the rated current and maintained-for a period of 15 min. At the end of the 15 min period, the power supply shall be switched off and the time of switching off recorded.
3	Thereafter, the readings as indicated in Clause 15.3.2.3.1(4) to (8) shall be recorded.
4	The temperatures of ambient, top oil, the top & bottom radiator header oil and the temperatures indicated by OTI and WTI shall also be recorded at the time of switching on 150% load as well as at the time of switching off the power supply.

15.3.2.3.3 **200% load**

1	After completion of the test at 150% load, the transformer shall be fed with power which shall be a value so as to cause circulation of rated current in the primary with the secondary windings short circuited. This current shall be circulated for 1 hour.
---	--

2	The current shall thereafter be increased to 200% of the rated current and be maintained for 5minute period. At the end of the 5 minute period the power supply shall be switched off and the time of switching off recorded.
3	Thereafter, the readings as indicated in clause 15.3.2.3.1(4) to (8) shall be recorded.
4	The temperatures of ambient, top-oil, top & bottom radiator header oils and temperatures indicated by OTI and WTI shall also be recorded at the time of switching on the 200% load as well as the time of switching of the power supply.

15.3.2.3 **Determination of thermal time constant of the winding:** The thermal time constant of the winding under both rated load and overloads shall be verified during the temperature-rise tests.

15.3.2.4 The temperature rise of the oil, winding and current carrying parts in air under both the overload conditions stipulated in Clauses 15.3.2.3.2 and 15.3.2.3.3 above shall not exceed the values stipulated in Clause 5.1(11), of this document. The winding hot-spot temperature under the overload conditions shall not exceed 115⁰C.

15.3.2.5 **Testing and calibration of the temperature indicators:** The functioning of the OTI and WTI shall be verified during the tests described above. Both the OTI and WTI shall be recalibrated, if necessary, to reflect the respective temperatures correctly. In particular, the reading of the WTI shall be the same as the calculated value of the hot-spot temperature of the winding.

15.3.2.6 **Determination of the thermal time constant of the WTI:** The thermal time constant of the WTI shall be determined for comparison with the thermal time constant of the winding of the transformer with respect to the transformer oil. For this purpose, the indications of the WTI and the OTI shall be recorded every 1 or 2 min during the first 1 h from the instant the transformer is loaded. From the slope of the curve plotted with the time on the X-axis and the difference between the readings of the WTI and OTI at the particular time on the Y-axis, the thermal time constant of the WTI shall be determined.

15.3.3 Lightning impulse test

15.3.3.1 This test shall be done in accordance with IEC 60076-3. The line and neutral terminals of the winding shall be tested with the following:

1	Highest voltage for Equipment Um, kV	52	12
2	Lightning impulse withstand voltage kV peak	250	75

15.3.4 Test with lightning impulse, shopped on the tail

15.3.4.1 This test shall be done in accordance with IEC 60076-3 with the appropriate test voltage as stipulated in Clause 15.3.3.1 above

15.3.5 Short-Circuit Test

The short-circuit test shall be conducted in accordance with IEC60076-5 with the following schedule:

15.3.5.1 Prior to commencement of the test, the following measurements/ tests shall be made:

- a) Insulation resistance of the winding with respect to the earth.
- b) No-load current.
- c) No-load loss.
- d) Resistance of windings.

- e) Percentage impedance voltage.
- f) Load loss.
- g) Voltage ratio.
- h) Di-electric tests comprising :
 - Separate – source voltage withstand test, and
 - Induced overvoltage withstand test.
- i) Recording of Surge Frequency Response Analysis (SFRA) as per IEC 60076-18.

15.3.5.2 The test will be done with secondary side short-circuited and energizing the primary side of the transformer at its rate voltage.

15.3.5.3 The transformer shall be subjected to a total of seven shots in the following sequence:

1st Shot	Symmetrical current
2nd Shot	Asymmetrical current
3rd Shot	Asymmetrical current
4th Shot	Symmetrical current
5th Shot	Symmetrical current
6th Shot	Asymmetrical current
7th Shot	Symmetrical current

15.3.5.4 The duration of each shot shall be 0.5s as per IEC 60076.

15.3.5.5 Measurement shall be done after each shot for the following:

1	Percentage impedance voltage
2	No-load current
3	No-load loss

15.3.5.6 Further testing and inspection of the transformer subjected to the short-circuit test shall be carried out as per IEC 60076-5 with the modification that:

1	The dielectric routine tests shall be at 100% of the original test value
2	The percentage impedance voltages measured after the short circuit test shall not vary by more than 2% from those measured before the sort circuit test.

15.3.5.7 On completion of the short-circuit test the transformer shall be un-tanked for inspection of the core and windings. In case the inspection of the core and winding do not reveal any apparent defects and the results of the short-circuit test, the values of percentage impedance voltage as also the results of the routine tests done after the short-circuit test are in order, the transformer shall be deemed to have passed the short-circuit test.

If any of the results of the tests are not in order or the inspection of core and windings reveals any defect, then the transformer shall necessarily have to be dismantled completely for detailed inspection.

15.3.6 Measurement of acoustic sound level

15.3.6.1 Measurement of acoustic sound level of the transformer energized at rated voltage and frequency shall be carried out either as per IEC 60076-10.

15.3.7 Measurement of Partial discharge quantity

15.3.7.1 Partial discharge quantity of the windings shall be measured in accordance with IEC 60076-3.

15.3.8 Measurement of harmonics of no-load current

15.3.8.1 The magnitude of harmonics of no-load current as expressed in percentage of the fundamental shall be measured by means of a harmonic analyzer, in accordance with IEC 60076-1.

15.4 Type tests on part, fittings and accessories

15.4.1 Bushings

15.4.1.1 The type tests shall be carried out in accordance with IEC 60137 on porcelain housing of the bushings. The following shall constitute the type tests:

- a) Visual inspection.
- b) Verification of dimensions
- c) Electrical routine test.
- d) Porosity test.
- e) Temperature cycle test.
- f) Bending test.

15.4.1.2 The type tests shall be carried out in accordance with IEC 60137 on the prototype of the bushings. The following shall constitute the type test:

- a) Wet power frequency withstand voltage test.
- b) Dry lightning impulse voltage withstand test.
- c) Thermal stability test.
- d) Temperature-rise test.
- e) Thermal short time current withstand test.
- f) Dynamic current withstand test.
- g) Cantilever load withstand test.
- h) Tightness test.
- i) Test of tap Insulation.
- j) Tightness test at flange or other fixing device.
- k) Measurement of partial discharge quantity.

15.4.2 Bushing type current transformers

15.4.2.1 The bushing type current transformers shall be tested in accordance with IEC60044-1.

15.4.3 Terminal connectors

15.4.3.1 The terminal connectors shall be tested in accordance with IS: 5561.

15.4.4 Temperature indicators

15.4.4.1 The following tests shall be conducted in prototypes of OTI and WTI:

1	Accuracy with reference to a standard instrument
2	Calibration of the indicators to reflect the actual temperature of the oil/windings
3	Dielectric test at 2.5kV for 60s.
4	Vibration test.

5	Dust and water splash test to IP 55 degree of protection.
---	---

15.4.5 Pressure relief device

15.4.5.1 The following tests shall be conducted on the prototype of pressure relief device:

- a) Air pressure test.
- b) Leakage test.
- c) Contact rating and operation test.
- d) Dielectric test on contacts at 2.5kV for 60 s.

15.4.6 Radiators

15.4.6.1 The radiators shall be tested for air leakage at a pressure of 2.5 kg/m². The pressure shall remain constant for 1 h to indicate that there is no leakage.

15.5 Insulating oil

15.5.1 The following tests shall be carried out in accordance with IEC 60296 on the sample of new insulating oil for use in the prototype transformer

- a) Density at 27⁰C
- b) Kinematic viscosity at 27⁰C
- c) Interfacial tension at 27⁰C
- d) Flash point.
- e) Neutralization value (acidity)
- f) Electric strength (with 2.5 mm gap)
- g) Dielectric dissipation factor (tan-delta)
- h) Specific resistance at 27⁰C and at 90⁰C
- i) Oxidation stability
- j) Water content

15.6 Routine tests

15.6.1 The following routine tests shall be performed on each transformer including the prototype unit in accordance with IEC 60076-1:

- a) Visual examination
- b) Insulation resistance test
- c) Measurement of no-load current
- d) Measurement of no-load loss
- e) Measurement of resistance of the windings
- f) Measurement of percentage impedance voltage
- g) Measurement of load loss
- h) Voltage ratio test
- i) Dielectric tests comprising
 - Separate-source voltage withstand test, and
 - Induced overvoltage withstand test

- j) Recording of SFRA as per IEC 60076.
- 15.6.2 Visual examination:** A general examination shall be made to check that the transformer conforms to the approved Drawings, various items are accessible for maintenance, the quality of workmanship and finish are of acceptable standards and all parts, fittings and accessories are provided.
- 15.6.3 Insulation resistance test:** The Insulation resistance of the winding with respect to the earth shall be measured using a 5 kV Megger.
- 15.6.4 Measurement of no-load current:** Measurement of no-load current referred to the primary side shall be done at 90%, 100%, and 110% of the rated voltage.
- 15.6.5 Measurement of no-load loss:** Measurement of no-load loss shall be done at 90%, 100% and 110% of the rated voltage.
- 15.6.6 Measurement of resistance of windings:** The resistance of the windings between the line and neutral terminals shall be measured and computed at 75⁰C.
- 15.6.7 Measurement of percentage impedance voltage:** The percentage impedance voltage shall be measured at rated current and at ambient temperature and computed at 75⁰C.
- 15.6.8 Measurement of load loss:** Load loss at rated current shall be measured at ambient temperature and computed at 75⁰C.
- 15.6.9 Voltage ratio test:** The voltage ratio shall be measured.
- 15.6.10 Dielectric tests**
- 15.6.10.1 Induced overvoltage withstand test:** The test shall be done as per IEC 60076-3.
- 15.6.10.2 Separate source voltage withstand test:** A test voltage of 28 kV shall be applied between the winding and tank.
- 15.6.11** Recording of Surge Frequency Response Analysis (SFRA) as per IEC 60076-18.
- 15.6.12** During the routine tests of any unit, if it is found that the sum of the measured losses (i.e. no-load and load losses) (corrected to 75⁰C) exceeds the value defined in Clause 15.3.2.3.1, or if the no-load loss/ load loss at the principal tapping exceeds the maximum guaranteed value defined in Clause 5.1 (12), the transformer shall be rejected.
- 15.7** If the prototype of a transformer conforming to this document and rating has already been approved in connection with previous supplies to Indian Railways, fresh type testing may be waived at the discretion of the Employer, provided that no changes whatsoever in the design or materials used or the process of manufacture have been made. However, the Employer reserves the right to conduct type tests if he deems it necessary to do so in the light of experience gained from previous supplies.
- 15.8** Only after approval of the original tracings of Drawings incorporating changes, if any, as a result of the prototype tests and clear written approval of the results of the tests on the prototype is communicated by the Engineer, to the successful bidder/manufacturer, shall he take up bulk manufacture of the transformer which shall be strictly with the same materials and process of manufacture as adopted for the prototype. In no circumstances shall materials other than those approved in -the design/Drawings and/or during the prototype testing be used for bulk manufacture-on the plea that they had been obtained prior to the approval of the prototype.
- 15.9** No charges are payable for type test and/ or routine tests.
- 15.10** Transformer before dispatch should be filled with Nitrogen / dry air and provided with a

gauge clearly visible for monitoring the pressure inside the tank.

16 TECHNICAL DATA AND DRAWINGS

16.1 The contractor shall furnish particulars in the proforma, at clause 20 the Schedule of Guaranteed Performance Technical and Other Particulars (SOGP) for the transformer. The particulars shall be complete in all respects. If there is any entry like shall be furnished later or a blank us left against any items, the offer is not likely to be considered as the evaluation of the offer is rendered difficult and cannot be compared with other offers, if any.

16.2 The contractor shall furnish the following information:

16.2.1 Calculations for:

- a) Temperature rise of winding at rated current.
- b) Hot-spot temperature of the winding at 150% and 200% rated loads for 15 min and 5 min respectively.
- c) Thermal withstand capacity of the windings for a short circuit of 5s duration.
- d) Mechanical force in respect of the following as per IEEMA (Indian Electrical & Electronic Manufacturer's Association) formulas given in Annexure-3:
 - i) Hoop stress in primary and secondary windings.
 - ii) Compressive pressure in the radial spacers.
 - iii) Internal axial compressive force.
 - iv) Axial imbalance force.
 - v) Radial bursting force.
 - vi) Resistance to collapse.
 - vii) Bending stress on clamping ring and densified wood.
 - viii) Maximum allowable torque on pressure screws for coil clamping bolts at the time of tightening, if any
- e) Flux density with the characteristic curve.
- f) Maximum value of inrush current.

16.2.2 Drawings for:

- a) Outline general arrangement Drawing giving complete details of the transformer
- b) Arrangement of the core, winding and magnetic path
- c) Magnetizing characteristic of CRGO sheet steel.

16.3 The successful bidder/manufacturer shall submit to the Engineer for approval the following detailed dimensioned Drawings as per Indian Railways standard in sizes of 210 mm x 297 mm or any integral multiples thereof:

- a) Outline general arrangement of the transformer indicating plan, front elevation, side elevation, with all parts, fittings and accessories, electrical clearances as well as salient guaranteed particulars.
- b) Internal arrangement of the transformer indicating line and neutral bushing lead connections core to core-clamp earthing, core-clamp to tank earthing, core-clamp

to Core-base bolting, and the locking arrangement of the core & coil assembly with the tank.

- c) Cross sectional view of the core and winding with material specifications and makes.
- d) Details of the pressure screws/ oil, dash-pot/ coil clamping bolts or other devices and their location with materials specification.
- e) Schematic view of the valves used on the transformer and the antitheft device so as to prevent theft of oil.
- f) Transport outline dimensional diagram.
- g) General arrangement of marshaling box indicating protection and control equipment.
- h) Wiring diagram of marshaling box.
- i) Schematic diagram of protection and control circuits in marshaling box with cable schedule.
- j) Legend plate showing protection and control circuits for fitment in the marshaling box.
- k) OIP condenser bushing for line terminal including cross-sectional view, shed profile and salient electrical and mechanical characteristics.
- l) Oil-filled porcelain bushing for neutral terminal including cross-sectional view shed profile and salient. Electrical and mechanical characteristics
- m) Dimensional Drawing, V-I characteristics and rating plate for bushing type current transformers.
- n) Rigid type terminal connector for line bushing terminal.
- o) Rigid type terminal connector for neutral bushing terminal.
- p) Rating plate with diagram of connections both in English and Hindi versions.
- q) Details of radiator
- r) Details of breather.
- s) External cables run with cable schedule.
- t) Any other Drawings considered necessary by the successful bidder/ manufacturer and / or Employer.

16.3.1 After approval, six copies of each of the approved Drawings along with two sets of reproducible prints for each Drawing shall be supplied.

16.3.2 Two copies of the "Operations and Maintenance manual" shall be supplied.

17 CAPITALISATION OF TRANSFORMER LOSSES (Not applicable)

17.1 (Deleted).

18 SPARES

The contractor shall supply 2 sets of the following:

- a) One line bushing complete with parts, fittings and bushing type current transformer.

- b) One neutral bushing complete with parts, fittings and bushing type current transformer.
- c) One complete set of gaskets of all sizes required for use in the transformer.
- d) One piece of radiator.
- e) One terminal connector each for line and neutral side bushing terminals.
- f) One set valves.
- g) One pressure relief device.

19 ERRECTION TESTING AND COMMISSIONING

19.1 The transformer shall be erected and commissioned by the Contractor. The successful bidder shall invariably make available at site the services of qualified personnel to ensure, by his continued presence, that the process of erection, testing and commissioning of the transformer is in accordance with established recommended practices. For this purpose prior intimation regarding the dates/period and locations at which the transformers are to be erected and testing/commissioning done shall be given by the Engineer to the successful bidder. No charges shall be payable by the employer to the successful bidder/manufacturer for the services of his engineer in this regard.

20 SCHEDULE OF GUARANTEED PERFORMANCE, TECHNICAL AND OTHER PARTICULARS (GUARANTEED PARTICULARS ARE TO BE ESTABLISHED BY ACTUAL TESTS/ TEST REPORTS)

SN	DESCRIPTION	UNIT OF MEASUREMENT	VALUE/ INFORMATION
1	2	3	4
A	<u>RATINGS/PARTICULARS</u>		
1.	Name of the Manufacturer		
2.	Country of manufacture		
3.	Reference to specification based on which performance data is prescribed		
4.	Rated power	MVA	
5.	Primary current at:		
	a) Rated load	A	
	b) 150% rated load for 15 min	A	
	c) 200% rated load for 5 min	A	
6.	Secondary current at:		
	a) Rated load	A	
	b) 150% rated load for 15 min	A	
	c) 200% rated load for 5 min	A	
7.	Rated voltage :		
	a) Primary	kV	
	b) Secondary (at no-load)	kV	
8.	Rated frequency	Hz	

9.		Temperature rise above ambient temperature of 50 °C :		
	(i).	Oil :		
		a) At rated load	°C	
		b) At 150% rated load for 15 min	°C	
		c) At 200% rated load for 5 min	°C	
	(ii)	Winding :		
		a) At rated load	°C	
		b) At 150% rated load for 15 min.	°C	
		c) At 200% rated load for 5 min	°C	
10		Hot-spot temperature of winding over ambient temperature of 50° C	°C	
		a) At rated load	°C	
		b) At 150% rated load for 15 min.	°C	
		c) At 200% rated load for 5 min	°C	
		Interval of time between two successive overloads after continuous working at full load, at maximum ambient temperature of 50°C:		
		a) Between two consecutive over loads of 50% for 15 min	min.	
		b) Between two consecutive min overloads of which one is of 50% for 15 min and the other of 100% for 5 min.	min.	
11		No-load current referred to primary side at rated frequency and at:		
		a) 90% rated voltage A		
		b) Rated voltage A		
		c) 110% rated voltage A		
12		Power factor of no-load current at rated voltage and rated frequency		
13		Value of the inrush current at rated voltage on primary side, the secondary side being open circuited		
14		Losses:		
	(i)	No-load loss at rated frequency and at:		
		a) 90% rated voltage	kW	
		b) rated voltage.	kW	
		c) 110% rated voltage.	kW	
	(ii)	Load loss (at 75 °C) at rated current and frequency	kW	
	(iii)	Total losses at rated current and frequency		
15		Resistance voltage (at 75 °C) at rated current	%	
16		Reactance voltage (at 75 °C) at rated current and frequency	%	
17		Impedance voltage (at 75 °C) at rated current and frequency	%	
18		Resistance (at 75 °C) of primary winding	Ohm	
19		Resistance (at 75 °C) of secondary winding	Ohm	

20		Reactance of winding :	H	
	i)	Primary	H	
	ii)	Secondary at	H	
21		Regulation (at 75 °C) with rated current and at power factor of:		
		a) Unity	%	
		b) 0.8 lagging	%	
22		Efficiencies:		
	(i).	Efficiency (at 75 °C) at unity power factor at:		
		a). 100% load	%	
		b). 75% load	%	
		c). 50% load	%	
		d). 25% load	%	
	(ii).	Efficiency (at 75 °C) at 0.8 power factor lagging at:		
		a). 100% load	%	
		b). 75% load	%	
		c). 50% load	%	
		d). 25% load	%	
	(iii)	Percentage of rated load at which maximum efficiency occurs.	%	
23		Ability to withstand short-circuit:		
		a). Thermal	S	
		b). Dynamic	S	
24		Thermal time constant (calculated):		
	(i)	for winding with respect to oil at:		
		a). rated current	Min	
		b). 150% rated current	Min	
		c). 200% rated current	Min	
	(ii)	Complete transformer at rated current	Min	
25		Temperature gradient between oil and winding at:		
		a). Rated current	°C	
		b). 150% rated current for 15 min	°C	
		c). 200% rated current for 5 min.	°C	
26		Temperature rise of oil:		
	(i).	Calculated average temperature rise of oil at:		
		a). Rated current	°C	
		b). 150% rated current for 15 min	°C	
		c). 200% rated current for 5 min	°C	
	(ii)	Estimated temperature rise of top oil at:		
		a). Rated current °C		
		b). 150% rated current for 15 min °C		
		c). 200% rated current for 5 min °C		

27		Details of core:		
	(i)	Type of core		
	(ii)	Flux density at rated voltage and frequency	Tesla	
	(iii)	Flux density at 110% rated voltage and frequency	Tesla	
	(iv)	Thickness of steel stampings	Mm	
	(v)	Grade of core material and conforming specification		
	(vi)	Exciting VA/kg for core stampings at:		
		a) Flux density of 1.55 tesla	VA/kg	
		b) Flux density at rated voltage	VA/kg	
		c) Flux density at 110% rated voltage	VA/kg	
	(vii)	Exciting VA/kg for assembled core at:		
		a) Flux density of 1.55 tesla	VA/kg	
		b) Flux density at rated voltage	VA/kg	
		c) Flux density at 110% rated voltage	Va/kg	
	(viii)	Type of Insulation between core laminations.		
	(ix)	Type of joint between the core limbs and yoke.	kV	
	(x)	Core bolt Insulation withstand voltage	kV	
	(xi)	Core bolt Insulation flashover voltage	kV	
28		Details of windings:		
	(i)	Type of winding		
		(a) Primary		
		(b) Secondary		
		(c) Number of turns of primary winding		
		(d) Number of turns of secondary winding		
		(e) Number of parallel paths in primary winding		
		(f) Number of parallel paths in secondary winding.		
		(g) Is interleaving/inter shielding of the winding adopted to ensure better impulse voltage distribution?	Yes/N o	
		(i) Primary		
		(ii) Secondary		
		(h) Is the Insulation of end turns of winding reinforced?	Yes/N o	
		(i) Primary		
		(ii) Secondary		
		(i) Type of coil		
	(ii)	Mode of connection (i.e. in series or in parallel) of the portions of the windings on the two limbs of the core, if applicable.		
	(iii)	Dimensions of the copper conductor used in the winding:		
		a) Primary	mm x mm	
		b) Secondary	mm x mm	
		c) Tapped winding.	mm x mm	
	(iv)	Current density at rated current.		

	a) Primary	A/mm ²	
	b) Secondary	A/mm ²	
(v)	Insulation used over the conductor (details of material and specification there for)		
(vi)	Type of joints, if any, in the windings		
(vii)	Dielectric strength of windings:		
	a) Full wave lightning impulse withstand voltage:		
	i) Primary winding	kV peak	
	ii) Secondary winding.	kV peak	
	(b) Lightning Impulse chopped on the tail withstand voltage:	kV	
	(i) Primary winding		
	(ii) Secondary winding		
	(c) Separate source power frequency withstand voltage	kV	
	(i) Primary		
	(ii) Secondary		
	(d) Induced over voltage withstand value		
(viii)	Minimum flashover distance to earth in oil of :		
	a) Secondary winding to core		
	b) Primary winding to yoke		
	c) Primary winding to tank		
(ix)	Material used for coil clamping rings and specification there for		
(x)	Magnitude of axial pre-compressive force on the winding		
	(a) Primary	kV peak	
	(b) Secondary	kV peak	
(xi)	Calculated maximum axial thrust in the winding due to dead short circuit at the terminals		
	(a) Primary		
	(b) Secondary		
(xii)	Calculated short circuit forces:		
	a) Hoop stress in primary winding	kgf/cm ₂	
	b) Hoop stress in secondary winding	kgf/cm ₂	
	c) Compressive pressure in the radial spacers		
	d) Internal axial compressive force	kgf/cm	
	e) Axial imbalance force		
	f) Resistance to college	Kgf	
	g) Bending stress on clamping	kgf/cm	

			2	
		h) Radial bursting force		
	(xiii)	Arrangement to maintain constant pressure on the windings		
	(xiv)	Maximum permissible torque on pressure screws for coil clamping at the time of tightening, if any.	N.m	
	(xv)	Can either end of each secondary winding (25 kV) be connected directly to earth?	Yes/No.	
29		Bushings:		
	(i).	Primary side:		
		a) Name of the manufacturer		
		b) Country of origin		
		c) Governing specification		
		d) Type designation (specify as to whether it is OIP condenser bushing)		
		e) Voltage class	kV	
		f) Rated current	A	
		g) Visible power frequency discharge voltage	kV	
		h) Wet one minute power frequency withstand voltage	kV peak	
		i) Lightning impulse withstand voltage	mm	
		j) Creepage distance		
		k) Weight of assembled bushing	Kg	
	(ii)	Secondary side		
		a) Name of the manufacturer		
		b) Country of origin		
		c) Governing specification		
		d) Type designation		
		e) Voltage class	kV	
		f) Rated current	A	
		g) Visible power frequency discharge voltage	kV	
		h) Wet one minute power frequency withstand voltage	kV	
		i) Lightning impulse withstand voltage	kV peak	
		j) Creepage distance	mm	
		k) Weight of assembled bushing	kgf	
30		Bushing type current transformers:		
	(i).	Primary side:		
		a) Name of the manufacturer		
		b) Governing specification		
		c) Transformation ratio		
		d) Accuracy class and rated accuracy limit factor		
		e) Rated current	A	
		f) Rated output	VA	

		g) Exciting current at the rated knee point emf	mA	
		h) Rated knee point emf	V	
		i) Secondary winding resistance corrected to 75°C	ohm	
		j) Short time thermal current and duration.	kA, s	
	(ii)	Secondary side:		
		a) Name of the manufacturer		
		b) Governing specification		
		c) Transformation ration		
		d) Accuracy class		
		e) Rated current	A	
		f) Rated output	VA	
		g) Exciting current at the rated knee point emf	mA	
		h) Rated knee point emf	V	
		i) Secondary winding resistance corrected to 75°C.	ohm	
		j) Short time thermal current and duration	kA, s	
31		Insulating oil :		
		a) Governing specification		
		b) Grade of oil		
		c) Source of supply		
		d) Specific resistance at:		
		i) 27 °C	ohm- cm	
		ii) 90 °C	ohm- cm	
		e) Dielectric, dissipation factor (tan-delta) at 90 °C-		
		f) Dielectric strength	kV	
		g) Water content	ppm	
		h) Interfacial tension	N/m	
		i) Neutralisation value	mg KOH/g m	
		j) Flash point	°C	
32		Type of transformer tank		
33		Details of radiators:		
		a) Make and type		
		b) Type of mounting		
		c) Overall dimensions (LxWxH)	mmx mm x mm	
34		Details of Buchholz relay:		
		a) Make and type		
		b) Governing specification		
		c) Provision of shut-off valves on either side of the relay	Yes/N o	
		d) Provision of alarm contact	Yes/N	

			o	
		e) Provision of trip contact	Yes/N	
			o	
		f) Rated current of contacts	A	
35		Details of winding temperature		
		Indicator.		
		a) Make and type		
		b) Governing specification		
		c) Number of contacts provided		
		d) Rated current of contacts	A	
		e) Dielectric withstand value of contacts	kV	
36		Details of oil temperature indicator		
		a) make and type		
		b) Governing specification		
		c) Number of contacts provided		
		d) Rated current of contacts	A	
		e) Dielectric withstand value of contacts	kV	
37		Details of Magnetic oil level gauge:		
		a) Make and type		
		b) Governing specification		
		c) Diameter of dial mm		
		d) Number of contacts provided		
		e) Rated current of contact	A	
		f) Dielectric withstand value of contacts	kV	
38		Details of pressure relief device:		
		a) Make and type		
		b) Governing specification		
		c) Does it reset itself	Yes/N	
			o	
39		Bimetallic terminal connectors:		
	(i)	Primary side:		
		a) Source of supply		
		b) Governing specification		
		c) Type		
		d) Rated current	A	
		e) Temperature rise over an ambient temperature of 45°C while carrying rated current.	°C	
		f) Short time current and duration	kA, s	
	(ii)	Secondary side:		
		a) Source of supply		
		b) Governing specification		
		c) Type		
		d) Rated current	A	

	e) Temperature rise over an ambient temperature of 45 ⁰ C while current rated current	°C	
	f) Short time current and duration	kA, s	
40	Acoustic sound level at a distance dB of 1 m, when energised at rated voltage and rated frequency without load.		
41	Partial discharge value at 1.5Um/ 3 kV r.m.s.	pC	
42	Weights and dimensions:		
	(i) Net weight of core		
	(ii) Net weight of cooper:		
	a) Primary winding	kg	
	b) Secondary winding	kg	
	(iii) Net untanking weight of core frame and coils	kg	
	(iv) Net weight of insulating oil	kg	
	(v) Volume of insulating oil	l	
	(vi) Total weight of cooling equipment	t	
	(vii) Total weight of transformer without oil	t	
	(viii) Total shipping weight of complete transformer including all detachable parts, fittings and assemblies	t	
	(ix) Shipping weight of largest package	t	
	(x) Crane lift (excluding slings) for un-tanking core and coils	mm	
	(xi) Crane lift (excluding slings) for removal of primary side bushings.	mm	
	(xii) Dimensions of the complete transformer including all parts, fitting and accessories:		
	a) Overall length	mm	
	b) Overall breadth	mm	
	c) From rail level to the topmost point	mm	
	(xiii) Minimum thickness of steel plate/ sheet used:		
	a) Bell tank mm		
	b) Tank bottom mm		
	c) Conservator mm		
	d) Radiator mm		
	e) Marshalling box. mm		
	(xiv) Overall shipping dimensions of the largest package (Length x width x height)	mm x mm x mm	
	(xv) Mode of transportation of transformer unit (filled with oil/nitrogen gas.)		
	Other particulars		
43	Is the transformer tank fitted with lifting pads? If yes, what is the number of pads	Yes/ No	
44	What is the number of inspection covers provided?		
45	Are comfits/ trays provided for cable run?	Yes/ No	

46	Is the core electrically connected with the tank?	Yes/No o
47	Will the gaskets to be used in the transformer give trouble free service for at least 7 years? If not, indicate the life.	Yes/No o
48	Is the core construction without core bolts?	Yes/No o
49	Are the core bolts grounded, and if so, how?	Yes/No
50	What is the number of radial spacers used in the winding?	
51	What is the number of joints provided in the winding?	
52	Are the spacers/blocks/angle rings of pre-compressed press boards? If no, indicate the material with specification.	
53	Are arrangements made for ensuring automatic constant pressure on the coils? If no. give the reasons.	Yes/No
54	Are closed slots provided on outer most winding for locking the vertical strips? If no, give the reason.	Yes/No
55	What is the periodicity for tightening of coil clamping arrangement?	Years
56	What are the designed values of short-circuit current for:	
	a) Symmetrical :	
	i) Primary winding A	
	ii) Secondary winding A	
	b) A symmetrical:	
	i) Primary winding A	
	ii) Secondary winding A	
57	What is the over flux withstand capability of the transformer (Maximum permissible limit of flux density)?	Tesla
58	Are windings pre-shrunk?	Yes/No o
59	Have the details of drying cycles of the coils/coil assembly including final tightening values of pressure, temperature and degree of vacuum at various stages of drying been furnished?	Yes/No
60	Are arcing horns provided for line and neutral bushings?	Yes/No
61	Is a test tap provided in the line bushing?	Yes/No
62	Is the porcelain housing of the bushings of single piece construction?	Yes/No
63	Is the shed profile of porcelain housing of the bushing free from under-ribs but has a lip?	Yes/No
64	Is the bushing type current transformer of low reactance type?	Yes/No

65		Is Clause by Clause "Statement of compliance" attached?	Yes/ No	
69		Are fasteners of 12 mm diameter and less exposed to atmosphere of stainless steel to Grade 04Cr17 Ni12Mo to IS 1570 Part-V?	Yes/ No	
70		Are the fasteners of more than 12 mm diameter exposed to atmosphere of stainless steel or MS hot dip galvanized?	Yes/ No	
71		Are test certificates for tests as per Clause 15.0 attached?	Yes/ No	
72		Are all the calculations required as per clause 16 enclosed.	Yes/ No	
73		Are all the Drawings required as per clause 16.3.2 attached?	Yes/ No	
74		(a) Are all the parts, fittings and accessories from Employer's approved manufacturers?	Yes/ No	
		(b) If not, list the items which are to be type tested in the presence of Employer's Personnel.	Yes/N o	
75		Is adequate space provided in the marshaling box for housing the wiring and components?	Yes/ No	

Appendix-10

JOINT DEED OF UNDERTAKING BY THE QUALIFIED EQUIPMENT MANUFACTURER ALONGWITH THE CONTRACTOR AND INDIAN EQUIPMENT MANUFACTURER/INDIAN PARTNER

THIS DEED OF UNDERTAKING executed this day of

Two Thousand and by

M/s., a Company incorporated under the laws of and having its
Registered Office at (hereinafter called the "*Qualified Equipment
Manufacturer*", which expression shall include its successors, executors and permitted assigns),

And

M/s., a Company incorporated under the Indian Companies Act of 1956 and
having its Registered Office at (hereinafter called the "*Indian Equipment
Manufacturer/Indian Partner*", which expression shall include its successors, executors and permitted
assigns),

Through

M/s., a Company incorporated under the laws of and having
its Registered Office at (hereinafter called the "*Contractor*", which
expression shall include its successors, executors and permitted assigns),

in favor of M/s Dedicated Freight Corridor Corporation of India Limited (DFCCIL), a Company
incorporated under the Indian Companies Act of 1956 and having its registered office at Room No.
101/A, Rail Bhavan, Raisina Road, New Delhi – 110001, India (hereinafter called the "*Employer*"
which expression shall include its successors, executors and permitted assigns).

WHEREAS:

1. The "*Employer*" has invited a bid as per its Tender Specification No.
for the execution of (*Insert name of the package along with project name*).
2. The "*Contractor*" at the time of bidding has submitted its bid to the "*Employer*" vide proposal
No.dated.....for the said package and accepted by the "*Employer*", resulting
into a contract (hereinafter called the "*Contract*").

3. The “Contractor” has selected “Qualified Equipment Manufacturer” along with its “Indian Equipment Manufacturer/Indian Partner”, for the supply of Equipment, who is the qualified manufacturer of transformers in line with the Clause No....., Section, of Volume..... forming part of the contract.
4. Under the provisions of the contract for the supply of the Equipment, the “Qualified Equipment Manufacturer” will supply _____ Nos. of Equipment “Indian Partner” will supply _____ Nos. of equipment.

NOW THEREFORE THIS UNDERTAKING WITNESSETH as under:

- 1.0 Without in any way affecting the generality and total responsibility in terms of this Deed of Undertaking, the Contractor, Indian Equipment Manufacturer/Indian Partner and the Qualified Equipment Manufacturer to ensure:
 - (i) Design of the Equipment manufactured in India shall be identical to the design of equipment to be manufactured and supplied by the Qualified Equipment Manufacturer.
 - (ii) Adequate up gradation of the facilities including quality systems at Indian works.
 - (iii) Training to staff of Indian Equipment Manufacturer/Indian Partner and certification to its trained personnel to carry out each activity.
 - (iv) Active involvement of Qualified Equipment Manufacturer expert in various stages of manufacturing such as for transformer winding manufacturing, core assembly, complete assembly, quality assurance and testing for the first unit of the Equipment at Indian Partner's works.
 - (v) MQP of Indian Equipment Manufacturer/ Indian Partner shall be same as that of Qualified Equipment Manufacturer.
 - (vi) Specification of raw material / major bought out components shall be same as that of Qualified Equipment Manufacturer.
 - (vii) Timely supply of the said equipment. In the event, the development takes time and does not meet the time schedule, Qualified Equipment Manufacturer shall supply all the equipment from their works to meet the completion schedule without any additional liability to the Employer.
 - (viii) If necessary the Qualified Equipment Manufacturer shall advise the Indian equipment manufacturer/Indian Partner and/or Contractor suitable modifications of designs and implement necessary corrective measures to discharge the obligations under the Contract.
 - (ix) The prototype tests shall be conducted for the equipment manufactured at the works of both i.e. Qualified Equipment Manufacturer as well as Indian equipment manufacturer/Indian Partner.
- 2.0 This Deed of Undertaking shall be construed and interpreted in accordance with the laws of India and the Courts in Delhi shall have exclusive jurisdiction in all matters arising under the Undertaking.

3.0 We, the Qualified Equipment Manufacturer/Contractor and/or The Indian Equipment Manufacturer/Indian Partner agree that this Undertaking shall be irrevocable and shall form an integral part of the Contract and further agree that this Undertaking shall continue to be enforceable till the Employer discharges it.

IN WITNESS WHEREOF the Qualified Equipment Manufacturer, The Indian Equipment Manufacturer/Indian Partner and/or the Contractor have through their Authorized Representatives executed these presents and affixed Common seals of their respective Companies, on the day, month and year first above mentioned.

WITNESS	(For Qualified Equipment Manufacturer)
Signature	(Signature of the authorized representative)
Name	Name
Office Address	Common Seal of Company

WITNESS	(For Indian Equipment Manufacturer/ Indian Partner)
Signature	(Signature of the authorized representative)
Name	Name
Office Address	Common Seal of Company

WITNESS	(For Contractor)
Signature	(Signature of the authorized representative)
Name	Name
Office Address	Common Seal of Company

Note:

1. The non-judicial stamp papers of appropriate value shall be purchased in the name of executants parties and the date of purchase should not be later than six months of date of execution of the Undertaking.
2. The Undertaking shall be signed on all the pages by the authorized representatives of each of the partners and should invariably be witnessed.

3. In the event the Contractor is an Indian transformer Manufacturer/Indian Partner and the Collaboration is between Qualified Transformer Manufacturer and the Contractor, then the Joint deed of undertaking shall be modified accordingly.

(End of Chapter 19)



**BID DOCUMENT
FOR
DESIGN, SUPPLY, CONSTRUCTION, INSTALLATION, TESTING AND
COMMISSIONING OF 2X25KV AC ELECTRIFICATION, SIGNALLING &
TELECOMMUNICATION, E&M AND ASSOCIATED WORKS ON
DESIGN-BUILD LUMP SUM BASIS FOR DADRI-KHURJA SECTION
(APPROXIMATELY 47 ROUTE KM OF DOUBLE LINE) OF EASTERN
DEDICATED FREIGHT CORRIDOR**

SYSTEMS WORKS CONTRACT PACKAGE 105

Issued on: 14.06.2017

ICB No.: HQ/SYS/EC/D-B/Dadri- Khurja

EMPLOYER'S REQUIREMENTS

Part-2, Section-VI

VOLUME 3: PARTICULAR SPECIFICATIONS - SIGNALLING WORKS

**EMPLOYER: DEDICATED FREIGHT CORRIDOR CORPORATION OF INDIA LTD
(A GOVERNMENT OF INDIA ENTERPRISE)**

MINISTRY OF RAILWAYS

COUNTRY: INDIA

TABLE OF CONTENTS

PART 1 – Bidding Procedures

- Section I. Instructions to Bidders
- Section II. Bid Data Sheet
- Section III. Evaluation and Qualification Criteria (Following Prequalification)
- Section IV. Bidding Forms
- Section V. Eligible countries

PART 2 – Employer's Requirements

- Section VI. Employer's Requirements
- Volume 1: General Specifications
- Volume 2: Particular Specifications – 2x25 kV, AC Traction Electrification and Associated Works
- Volume 3: Particular Specifications – Signalling Works**
- Volume 4: Particular Specifications – Telecommunication Works
- Volume 5: Particular Specifications – E&M and Associated Works

PART 3 – Conditions of Contract and Contract Forms

- Section VII. General Conditions (GC) As per FIDIC Yellow Book 1999-Edition
- Section VIII. Particular Conditions
 - *Appendix to Tender*
- Section IX. Contract Forms

PART 4 – Reference Documents

1. Alignment Plans, Yard Plans and Building Plans
2. Power Supply, Distribution, OHE and SCADA system Schemes & layouts and S&T Drawings
3. DFCC-Environmental Assessment Report for Khurja - Dadri Section
4. Environmental Management Framework(EMF) for EDFC
5. DFCC– Resettlement Action Plan for Khurja- Dadri Section
6. DFCC-SHE Manual
7. Specification for 12000hp locomotive and Tractive effort Curve
8. IR's Transmission line Network and DFCCIL's Traction Sub Station (TSS) Connectivity

VOLUME-3: PARTICULAR SPECIFICATIONS: SIGNALLING WORKS

TABLE OF CONTENTS

CHAPTER 1: INTRODUCTION	4
1.1 INTRODUCTION	4
1.2 OBJECTIVE	4
1.3 SIGNALLING OVERVIEW.....	5
1.4 SCOPE OF WORKS.....	6
1.5 RELEVANT DOCUMENTS.....	8
CHAPTER 2: DEFINITIONS AND ABBREVIATIONS	9
2.1 DEFINITIONS.....	9
2.2 LIST OF ABBREVIATIONS.....	10
CHAPTER 3: SYSTEM REQUIREMENTS.....	13
3.1 INTRODUCTION	13
3.2 SIGNALLING SYSTEM REQUIREMENTS	14
CHAPTER 4: PERFORMANCE REQUIREMENTS.....	34
4.1 SYSTEM PERFORMANCE	34
4.2 RELIABILITY, AVAILABILITY, MAINTAINABILITY (RAM)	34
4.3 RELIABILITY MODELLING.....	35
4.4 FAILURE DEFINITIONS.....	35
4.5 RELIABILITY REQUIREMENTS	36
4.6 AVAILABILITY.....	36
4.7 PERTURBATION ANALYSIS.....	37
4.8 MAINTAINABILITY	37
4.9 LOWEST REPLACEABLE UNIT (LRU)	38
4.10 SAFETY ENGINEERING.....	38
4.11 SYSTEM SAFETY PLAN	38
4.12 RAM DEMONSTRATION	46
4.13 ENVIRONMENT	48
4.14 EMC/EMI REQUIREMENTS.....	48
CHAPTER 5: GENERAL REQUIREMENTS.....	51
5.1 PROJECT DESIGN STANDARDS.....	51
5.2 PROCUREMENT.....	55
CHAPTER 6: CONSTRUCTION REQUIREMENTS.....	56
6.1 GENERAL.....	56
6.2 INSTALLATION	56
6.3 SIGNALLING CABLE LAYING, TERMINATION AND TESTING.....	59

6.4	EARTHING AND BONDING	71
	CHAPTER 7: TESTING AND COMMISSIONING	77
7.1	GENERAL	77
7.2	TYPE TESTS	77
7.3	FACTORY ACCEPTANCE TESTS	77
7.4	INSTALLATION TESTS	78
7.5	SYSTEM ACCEPTANCE TEST	80
7.6	INTEGRATED TESTING AND COMMISSIONING	81
7.7	TRIAL RUNS	82
7.8	STATUTORY CLEARANCES	83
	CHAPTER 8: DOCUMENTATION	84
8.1	GENERAL	84
8.2	LIST OF DOCUMENTS	84
	CHAPTER 9: TRAINING	87
9.1	GENERAL	87
9.2	OBJECTIVES OF TRAINING	87
9.3	TRAINING COURSES	87
	CHAPTER 10: SPARES, SPECIAL TOOLS AND TEST EQUIPMENT	91
10.1	GENERAL	91
10.2	SUPPLY OF SPARES	91
10.3	SPECIAL TOOLS AND TEST & MEASURING EQUIPMENT	94
	CHAPTER 11: INTERFACE REQUIREMENTS	97
11.1	GENERAL	97
11.2	INTERFACE WITH CST CONTRACTOR (CP 302)	97
11.3	INTERFACE WITH SYSTEM CONTRACTOR (CP 104)	100
11.4	INTERFACE WITH INDIAN RAILWAYS	101
11.5	INTERFACE WITH WDFC CONTRACTOR (CTP 14)	101
	Appendix 1	102
	Appendix 2	117
	Appendix 3	125
	Appendix 4	139
	Appendix 5	140
	Appendix 6	143
	Appendix 7	144

CHAPTER 1: INTRODUCTION

1.1 INTRODUCTION

- 1.1.1 Eastern Dedicated Freight Corridor (EDFC) Railway project will run from Ludhiana to Dankuni. Phase - 1 of the EDFC project involves construction of the stretch from Bhaupur to Khurja to Dadri. The details of the section are given in Para 1.3 of General Specifications, Vol.1 Part 2 Section VI.
- 1.1.2 Dadri- Khurja section (EDFC Phase 1) will be double line railway track with one Junction Station, New Boraki.
- 1.1.3 New Boraki Junction Station will be connected to New Dadri WDFC Station through twin single lines taking off from Common Loop 1 & 2 of New Boraki Station. There will be an Up line & bi-directional line connection to IR Dadri ICD yard and a bi-directional line connection to IR Dadri Third line, from Up and Down Lines of New Boraki Junction Station.
- 1.1.4 There are at present 13 level crossing gates in this section which are planned to be replaced with RUBs by DFCCIL/IR.
- 1.1.5 To provide integrated maintenance facilities for all functions – Civil, Electrical, S&T at a centralized location, an Integrated Maintenance Sub Depot (IMSD) has been planned to be constructed at New Boraki.
- 1.1.6 The EDFC Centralized Operational Control Centre, being provided at Allahabad under another contract CP - 104, will be used to house the Train Management system (TMS) and Traction Power SCADA system of EDFC. The details of OCC are covered in Para 1.3.6 of General specification Vol.1 Part 2.
- 1.1.7 The Civil Structures and Track works in Dadri - Khurja section are being executed under another contract, CP 302. The present work is for construction of Railway Electrification, Signalling and Telecommunication system on Dadri – Khurja section of EDFC Phase 1. This specification details the technical requirements for the Signalling system to be implemented on this section.
- 1.1.8 The Contractor shall consider the Project Objectives and scope of works contained in this chapter and then using the requirements given in this document, develop an appropriate Signalling system that meets the System requirements for design, implementation and support.

1.2 OBJECTIVE

- 1.2.1 The objective is to design, build, install and test a safe and reliable Signalling system for the Dadri – Khurja section of EDFC Phase -1.
- 1.2.2 Safety is of primary concern. The aim is to minimize accidents and incidents during the implementation phase of the project, as well as to reduce operational accidents and incidents when the new Signalling system is brought into use.
- 1.2.3 It is an objective to install a system that will be designed to have a prolonged life cycle. As such, any of its sub-system installed should be capable of mid-life upgrade with minimal disruption to traffic operations. The Equipment is expected to remain operational during wide environmental conditions found along the proposed route.

- 1.2.4 The maintenance cost of the system should be kept to the minimum. The Signalling system should therefore be designed to require minimal maintenance and a suitable maintenance strategy shall be agreed with the Employer. The strategy shall incorporate the use of diagnostic data acquisition and storage to support the system maintenance authority.
- 1.2.5 It is an objective to install all equipment in the minimum time available commensurate with the project aims. To achieve this, the Signalling system is to be designed on a modular basis such that a generic design exists at all stations as far as possible, with variations to meet the local requirements. The contractor is encouraged to design the Signalling system in such a way that it can be pre-fabricated and tested at a central place away from the site and then delivered to site and installed. Commissioning and bringing into service of the Signalling may be achieved in sections in the most effective operational manner as agreed with the Engineer.
- 1.2.6 It is an objective to ensure that the environmental impact associated with the Signalling works is minimized.
- 1.2.7 It is an objective to minimize the energy cost. The Signalling system shall be designed for minimum energy consumption.
- 1.2.8 It is an objective to encourage innovation and innovative solutions that allow for a rapid implementation of the Signalling system. The contractors are encouraged to offer innovative, modular solutions to meet the system requirements.

1.3 SIGNALLING OVERVIEW

- 1.3.1 The section from Khurja to New Boraki will be provided with Automatic Block Signalling (ABS). The automatic/ semi-automatic signals en route will be set for a through and uninterrupted run in normal conditions.
- 1.3.2 The sections from New Boraki to Dadri (IR) and New Boraki to New Dadri (WDFC) shall work on Absolute Block/Slot Working.
- 1.3.3 The Signals, Points, Track-vacancy detection systems and other Signalling equipment at the station and in the block sections will be controlled/monitored by Electronic Interlocking (EI) located at Station and at Auto Location Huts along the route. The Electronic Interlocking architecture including their size, numbers, locations and bandwidth requirement for the system shall be determined by the contractor's design. The OFC system required for communication between the EIs shall be provided under PS - Telecommunication works, Vol 4, Part 2.
- 1.3.4 It is a requirement that Digital Axle counter technology is used to provide primary track vacancy detection function at the Station and in the Block Sections. The Track vacancy detection system architecture including size, numbers and locations shall be determined by the contractor's design. The OFC, if used for communication between the Evaluator and Track Devices will be provided under PS – Telecommunication Works, Vol 4, Part 2.
- 1.3.5 Power supply for the Signalling System shall be provided using Integrated Power Supply (IPS)/Uninterrupted Power Supply (UPS). The Power supply scheme including rating, quantity and locations of Power supply systems, shall be determined by the contractor's design.
- 1.3.6 The Train Management System (TMS) shall be housed in OCC at Allahabad. The TMS will collect real time data of important Signalling functions of the Station and Block Sections and display it in the OCC. For this purpose, the OFC system required for

communication shall be provided under PS – Telecommunication works, Vol 4, Part 2. The Traffic Controllers at the OCC shall be provided with an overview of the movement of trains on a Video Wall, sufficient to supervise and monitor train movements across the whole section and will control train operations by verbal communication over Telephone system provided under PS – Telecommunication works, Vol 4, Part 2.

- 1.3.7 While the Traffic controllers at OCC will manage overall train operations, the operations at local level will be managed by Station Master located at the station along the route. Station Master will require an appropriate display and sufficient control to support its activity under both normal and abnormal train operations. The Station Master will receive train service and management information from the Traffic Controller located at the OCC.
- 1.3.8 The 'Traction Power SCADA Control system' is being provided under Particular Specifications – 2x25 kV AC Traction Electrification and Associated Works, Vol. 2, Part 2. The Video wall for display of SCADA system as well as the SCADA Channels shall, however be provided by the Signalling system under this specification.
- 1.3.9 The Power supply scheme for Signalling system shall be based on 230V 50 Hz AC supply, the details of which are covered under PS – E & M and Associated Works Vol 5, Part 2.
- 1.3.10 The Signalling equipment shall be housed in Signal Equipment Rooms (SER). While SER at Station will be constructed as part of Station building under Contract Package 302, the Signal Equipment rooms and Power Supply Equipment rooms for housing Signalling equipment at Auto Location Huts in the Block sections and Relay Huts, if any at Stations/Block sections, shall be built by the Contractor. The number, size and location of such Signalling Equipment rooms and Power Supply Equipment rooms in Block sections and Stations shall be determined by the Contractor's design.
- 1.3.11 The Signal Maintenance bases will be located in IMSD. The building for IMSD is being constructed under Contract Package CP - 302.
- 1.3.12 An Overview of Signalling system architecture and its Interface is placed at Appendix 6.

1.4 SCOPE OF WORKS

- 1.4.1 The Signalling system scope is comprised of the following:
- (1) Design and Implementation of the Signalling works using Electronic interlocking and MSDAC, including power supply system at New Boraki Junction station. This shall include all the Signalling works, using Electronic interlocking and MSDAC including power supply system on a continuous stretch of Up and Down Lines extending up to and including Point Zone controlling movement to/from Indian Railway's Dadri (ICD) yard – Dadri area.
 - (2) Design and Implementation of Automatic Signalling using Electronic interlocking and MSDAC, including power supply system on DFCCIL Main lines from New Khurja to New Boraki. This shall include facility for introduction of Modified Semi-automatic working during abnormal conditions such as Fog, bad weather, poor visibility etc. This shall also include all necessary alterations in Signalling and power supply works at New Khurja Station provided under another contract, CP-104, required to implement the system. The OFC system required for implementation of the system shall be provided under PS- Telecommunication works, Vol 4, Part 2.

- (3) Design and Implementation of Absolute Block/ Slot Working on twin single lines connecting New Boraki Junction Station (EDFC) to WDFC. This would include carrying out all Signalling Works including track detection system in EDFC portion up to Km 1412.660 (corresponding WDFC Km 142/111.680) on twin single lines. The Signalling works for implementation of Absolute Block/ Slot Working on twin single lines between New Boraki Station (EDFC) and WDFC will be done by the respective EDFC and WDFC contractors in their area of jurisdiction. The Contractor would, however be responsible for coordinating with the WDFC contractor for exchange of Signalling information (Signals aspects, track detection etc.) required for implementation of Absolute Block/ Slot Working, at a suitable interface point between EDFC and WDFC.
- (4) Design and Implementation of Absolute Block/ Slot Working on lines connecting New Boraki Junction Station/Area (EDFC) to Indian Railway's Dadri (ICD) yard – Dadri area. This shall include carrying out all Signalling Works including track detection system on EDFC line connections (one Up line and one bidirectional line) to Dadri ICD yard up to and including Home Signal and Advance Starter at IR end, and EDFC bidirectional line connection to Dadri Third line. This shall also include complete Signalling work, including cabling and power supply arrangement in the New Boraki Junction station/area of EDFC and Dadri (ICD yard) – Dadri area of IR, as required for implementation and operation of Block/Slot working between EDFC Station Master seated at New Boraki Junction Station and IR Station Master seated at Dadri Junction Station. . Any alterations to existing signalling on IR Dadri (ICD) yard –Dadri area shall be carried out by IR.
- (5) "Design and Implementation of a Train Management System with associated power supply and its seamless integration with the Train Management System (TMS) being provided under Contract Package CP-104 for supervision, management and monitoring of train traffic and its power supply system. This shall include provision of Video Wall Display at OCC for Signalling and SCADA system of Khurja-Dadri section. This shall also include undertaking all modifications/augmentation in TMS and associated power supply being provided under CP 104.
- (6) Design and implementation of Service & Diagnostic (S&D) system with associated power supply, and its seamless integration with S&D system being provided under Contract Package CP-104, for monitoring and supervision of health of Signalling equipment. This shall include undertaking all modifications/augmentation in S&D system and associated power supply being provided under CP - 104.
- (7) "Design and implementation" means all activities associated with designing a Signalling system to meet the Employer's requirements, manufacture & supply, storage, Installation/Construction, testing and commissioning, training, supply of spares and documentation, removal of temporary works, handover of the system to the Employer and support during Defect Notification period as per provisions of Employers Requirements.
- (8) All associated works required for satisfactory completion of works as defined in these Particular specifications

1.5 RELEVANT DOCUMENTS

- 1.5.1 This Particular Specification (PS) shall be read in conjunction with the Conditions of Contract, the General Specification (GS), and any other document forming part of the Contract.
- 1.5.2 In the event of a conflict between the GS and PS - Signalling Works, the requirements of PS-Signalling Works shall prevail.
- 1.5.3 In the event of a conflict between this document and others, the following precedence shall apply:
- (1) Employer's Requirements - Particular Specifications-Signalling Works
 - (2) Employer's Requirements - General Specifications.
 - (3) Indian Standards referenced herein.
 - (4) International Standards referenced herein.
 - (5) Other International Standards.
 - (6) Other National Standards.
- 1.5.4 Notwithstanding the precedence specified above, the Contractor shall seek clarification from the Engineer in the event of conflict among above specifications and decision of the Engineer shall be final and binding.

(End of Chapter 1)

CHAPTER 2: DEFINITIONS AND ABBREVIATIONS

2.1 DEFINITIONS

- 2.1.1 **Availability:** The probability that an item will be in a state to perform a required function under given conditions at a given instant of time or over a given time interval assuming that the required external resources are provided.
- 2.1.2 **Control Terminal:** An Industrial grade computer complete with hard disc, VDU display monitor, key board and mouse, provided with SM.
- 2.1.3 **Design life:** The design life is the period of time during which the system is expected to work satisfactorily within its specified parameters.
- 2.1.4 **Failure:** A failure is an event which causes loss of function or performance within any part of the Signalling & Train Control System and requires a maintenance intervention to restore full functionality and performance.
- 2.1.5 **Flank Protection:** Protection of a train running on route set for it from trains or vehicles on neighbouring lines through setting & locking of concerned points in required position.
- 2.1.6 **Fouling Point:** The position at the convergence of two tracks where the kinematic envelopes, one on each line, would come into contact.
- 2.1.7 **Graceful Degradation:** The transfer in quality or performance from the initial level to a lower operable level.
- 2.1.8 **Headway:** Minimum time interval between successive trains at any point on the line such that the speed of a train is not reduced by presence of any other train ahead.
- 2.1.9 **Independence:** The isolation between the investigating technician undertaking the work and a second person for example, responsible for checking or approving the work.
- 2.1.10 **Level Crossing:** Is the rail – road surface crossing.
- 2.1.11 **Man Machine Interface (MMI):** The visual interface between the controller and the control system. MMI consists of computer screens, displayed objects, icons, and equipment as well as the facilities by which the Controller executes control.
- 2.1.12 **Maintainability:** A characteristic of design and installation, expressed as the probability that an item will be retained in or restored to a specified condition within a given period of time, when the maintenance is performed in accordance with prescribed procedures and resources.
- 2.1.13 **Mean Time Between Failures (MTBF):** The average time between failures causing service delays for a piece of equipment, a system or a subsystem.
- 2.1.14 **Mean Time to Repair/ Restore (MTTR):** The average time being required to repair a piece of equipment, system or subsystem to restore to its proper working conditions.
- 2.1.15 **Reliability:** The probability that an item/equipment/system can perform a required function under given conditions for a given time interval.
- 2.1.16 **Running Lines:** The DFCCIL Running lines between Khurja – Dadri stations.
- 2.1.17 **Safety:** Freedom from unacceptable risk.
- 2.1.18 **Subsidiary signals:** Signals which control the movement of trains within the station section viz. Shunt signals – Independent or below Main signals, Calling-on signals.
- 2.1.19 **Supervisory Track Section:** A Section of track between two DPs completely covering

more than one track sections. Supervisory Track Section is used to automatically reset Track Sections under its jurisdiction.

- 2.1.20 **TMS terminal:** A terminal having MMI device with video display unit (VDU), Keyboard and mouse.
- 2.1.21 **Traffic Controller:** The person deputed to control and regulate working of traffic on specified section of the railway provided with a system of speech communication.
- 2.1.22 **Track Section:** A Section of track between two DPs used for controlling the signal depending upon its clearance or otherwise
- 2.1.23 **Video wall:** A graphical representation of the railway and its global operating status.
- 2.1.24 **Vital Relay:** The Relays used for Vital equipment such as Signal, Point, Track detection etc. whose correct operation is essential to the integrity of the Signalling system.
- 2.1.25 **Wrong side Failure:** A failure of a safety-critical system or subsystem which directly leads to a situation with the potential to cause harm, human injury, damage to property, plant or equipment, damage to the environment, or economic loss.

2.2 LIST OF ABBREVIATIONS

ABS	Automatic Block Signalling
AC	Alternating Current
ACO	Automatic Change over
ACTM	Alternating Current Traction Manual
ALH	Auto Location Hut
AT	Auxiliary Transformers/ Auto Transformer
CB	Circuit Breaker
CD	Compact Disc
CENELEC	European Committee for Electro Technical Standards (Comité Européen de Normalisation Electro technique).
CIU	Central Interlocking Unit
CMS	Crew Management System
CST	Civil, Structures and Track
CTC	Centralized Traffic Control
CTR	Cable Termination Rack
DAC	Digital Axle Counter
DG	Diesel Generator
DN	Down Direction
DP	Detection Point
DNP	Defect Notification Period
DLP	Defect Liability Period
ELD	Earth Leakage Detector
EI	Electronic Interlocking
ELB	Electric Lifting Barriers
EMC	Electro Magnetic Compatibility

EMI	Electro Magnetic Interference
EN	Euro Norm
FIU	Field Interface Unit
FMECA	Failure Mode Effects and Criticality Analysis
FRACAS	Failure Reporting and Corrective Action System
G&SR	General and Subsidiary Rules
GCC	General Conditions of contract
GPS	Global Positioning System
HDD	Hard Disc Drive/ Horizontal Directional Drilling
HDPE	High Density Poly Ethylene
Hz	Hertz
I/O	Input / Output
ICD	Interface Coordination Document
IEC	International Electro–Technical Commission
IEEE	Institute of Electrical and Electronics Engineers
IMD	Integrated Maintenance Depot
IMP	Interface Management Plan
IMSD	Integrated Maintenance Sub Depot
IPS	Integrated Power Supply
IRPWM	Indian Railway Permanent Way Manual
IRSEM	Indian Railway Signal Engineering Manual
ISA	Independent Safety Assessor
ISO	International Standards Organization
Km / KM	Kilo Meter
KVA	Kilo Volt Ampere
LAN	Local Area Network
LED	Light Emitting Diode
LC	Level Crossing
LRU	Lowest Replaceable Unit
LV	Line Verification
LVR	Line Verification Relay
MACLS	Multiple Aspect Colour Light Signal
MIS	Management Information System
MCB	Miniature Circuit Breaker
MMI	Man Machine Interface
MSDAC	Multi Section Digital Axle Counter
MTBF	Mean Time Between Failure
MTTR	Mean Time To Restore
MTBSAF	Mean Time Between Service Affecting Failure
NMS	Network Management System

NDA	Non-Descript Alarm
OCC	Operations Control Centre
OEM	Original Equipment Manufacturer
OFC	Optic Fibre Communication
OHE	Over Head Equipment
PC	Personal Computer
RAM	Random Access Memory
RAMS	Reliability, Availability, Maintainability and Safety
RE	Railway Electrification
RH	Relay Hut
RSTR	Reset Relay
SAT	System Acceptance Test
SCADA	Supervisory Control and Data Acquisition
S&D	Service and Diagnostic
SOD	Schedule of Dimension
SER	Signal Equipment Room
SP	Sectioning Point
SPAD	Signal Passed at Danger
SSDAC	Single Section Digital Axle Counter
TDS	Train Describer System
TMS	Train Management System
TPC	Traction Power Controller
UPS	Uninterruptible Power Supply
UFSBI	Universal Fail Safe Block Interface
UP	Up Direction
VDU	Video Display Unit
VRLA	Valve Regulated Lead Acid
WDFC	Western Dedicated Freight Corridor

(End of Chapter 2)

CHAPTER 3: SYSTEM REQUIREMENTS

3.1 INTRODUCTION

- 3.1.1 A new Signalling system is required for the New Khurja – New Boraki – Dadri (ICD) - Dadri area & New Boraki – WDFC section. The main components of the system shall be Electronic Interlocking, Track vacancy detection using Digital Axle Counters, Line Side Signals, Point Machines, Service and diagnostic system and Train Management System.
- 3.1.2 The Signalling system shall be engineered for a minimum Service Life of 20 years, based on continuous operation of the system. The life of individual Signalling equipment, shall not be less than that stipulated in the Finance Code of Indian Railways with latest amendment.
- 3.1.3 For reasons of operational availability, a distributed control capability is required with an interlocking used within station area of control to ensure points and signals do not conflict and that the train is protected from point movement during its passage.
- 3.1.4 It is anticipated that Centralized Traffic Control (CTC) and Train Protection Warning System (TPWS) may be required in the future. Therefore, system provided under this contract shall be designed as demonstrable to be “future proofed” for the same.
- 3.1.5 The System shall be designed in such a manner that the failure of a single item of equipment shall not cause loss of overall system functionality. The use of redundancy, hot standby and cold standby shall be considered in accordance with meeting the system objectives.
- 3.1.6 The system shall remain fully functional with no degradation across the range of published climatic conditions found in the region covered under Para 2.17 of GS Vol. 1 Part 2 Section VI.
- 3.1.7 The system shall be designed to be repaired without loss of overall functionality.
- 3.1.8 The system shall be designed to operate correctly and safely within a 2x 25 KV AC AT feeding system environment of DFCCIL and 25 KV AC feeding system environment of IR, and shall present no hazards to personnel.
- 3.1.9 The system design shall be modular and amenable to assembly and testing away from the final installation site.
- 3.1.10 The system shall be designed keeping energy usage as a key feature of design philosophy and making it part of the review of the system design.
- 3.1.11 The system shall be designed and installed in such a manner that theft and vandalism are discouraged. Line side units shall feature locks and similar deterrent features preventing plug coupled cables and modules from being removed and larger structures shall feature anti vandalism measures to the satisfaction of the Engineer.
- 3.1.12 The system shall be designed to incorporate a Service and Diagnostic system to be used to support railway maintenance activities.
- 3.1.13 The System shall be designed to interface and integrate seamlessly with Signalling systems on adjacent sections of EDFC, WDFC and those of connecting IR station.

3.2 SIGNALLING SYSTEM REQUIREMENTS

3.2.1 General

- (1) Automatic Signalling shall be provided on Main lines in a continuous stretch from New Khurja – New Boraki with 4 Aspect Colour Light Signals (MACLS) at a nominal spacing of 2 Km.
- (2) Facility shall also be provided for introduction of Modified Automatic Working during abnormal conditions such as Fog, bad weather, poor visibility etc. This is to be achieved by modifying a mid-section Automatic Signal in each direction and in each block section into Modified Semi-Automatic stop signal and suitably interlocking it with Home Signal of station ahead and Advance Starter of station in rear in accordance with Indian Railway (Open line) General rules 1976 sub rule (1) clause (ba) of rule 3.12 & sub rule (3) of rule 9.01.
- (3) Absolute block working on lines connections in New Boraki – Dadri (IR) and New Boraki – WDFC yard sections shall be provided using Solid State Block proving by Axle Counter as per RDSO spec. RDSO/SPN/175/2005 or Block proving by Axle Counter using UFSBI as per RDSO spec. IRS: S105/2012. Wherever provision of Absolute Block working, as described above, is not feasible provision of Slot working with all necessary safety features and counters be considered.
- (4) Station area shall be designed for maximum flexibility and shall be fully signalled in accordance with current IR practices.
- (5) Interlocking of Stations and Block sections shall be provided using Electronic Interlocking.
- (6) Track Vacancy Detection System shall primarily use Digital Axle Counters (DAC).

3.2.2 Signals

(1) System Requirements

- (a) All Signals and Subsidiary signals should be designed and implemented in accordance with Indian railways General rules and Signal engineering Manual and other requirements of this specification.
- (b) The design of the proposed Automatic Block Signalling system shall, as far as possible avoid positioning of signals at following locations, where they can display a red 'STOP' aspect:
 - (i) Where trains may stop inside a tunnel;
 - (ii) Where trains may stop on top of a viaduct;
 - (iii) Where trains may stop across a junction or a point of conflict with another train;
 - (iv) Where trains may stop over a level crossing;
 - (v) Where trains may stop inside or too close to an OHE Neutral Section;
 - (vi) Where trains may stop at steep up/down gradient;
 - (vii) Where trains may stop in a position that is considered dangerous.
- (c) All Main line signals shall be 4 aspect Colour light automatic/semi-automatic line side signals. The signals on the loop lines shall be 3 aspect or 2 aspect Manual signals, as decided by the Engineer

- (d) All the automatic/ semi-automatic signals shall be fitted with A marker disc, G marker disc, illuminated 'A' marker and illuminated 'AG' marker in accordance with provisions of IR General Rules and Signal Engineering Manual.
- (e) A CSL board shall be provided on the Starter signals indicating Clear Standing Length of the line.
- (f) Position light type Shunt signals shall be provided below all Starter and Intermediate Starter signals.
- (g) Independent Position light type Shunt signals shall be provided for exit from sidings and shunt back from Advanced Starter. Sufficient number of such Shunt signals shall be provided so as to allow maximum flexibility in shunting movements in the yard.
- (h) Calling-ON signal shall be provided below Home signals and Intermediate Starter signals on extended loops of Junction station.
- (i) The Signals leading to more than one route shall be provided with Junction type Route indicators.
- (j) All the Signals - Main and Auxiliary, shall be equipped with LED signal lighting units.

(2) Technical requirements

The Colour light tubular signal posts, outside dia. 140mm, length 3.6/4.6/5.6 meters (as per requirement) complete with surface base, anchor bolts, ladder with platform guard rail etc. shall be provided as per spec No. IRS-S-6/81 and relevant RDSO drawings.

- (a) The Main running signals shall be Multi unit Colour Light Signals as per RDSO spec. No. IRS: S26-64 and relevant RDSO drawings.
- (b) All signals, main or subsidiary shall use Light Emitting Diode Signal lighting unit as per RDSO specification No. RDSO/SPN/153/2011. LED Signal lighting unit shall work on 110V 50 Hz AC. ECRs as per RDSO specification STS/E/Relays/AC Lit LED Signal/09-2002 shall only be used with LED Signal lighting units.
- (c) Directions type (Junction Type) route Indicators (5 lamp unit arm) using LED signal light, complete with all the fittings shall be supplied as per IRS: S-66/1984 and relevant RDSO drawings.
- (d) Installation of Signals
 - (i) Signals shall be installed clear of the structure gauge as per the provisions of IRSEM and SOD of EDFC.
 - (ii) The Signal shall be so located that a clear view is available to the driver of an approaching train and is as close to the track as permissible. The actual visibility of signal shall be checked by a Sighting committee and action to improve the visibility as per recommendation of the committee shall be taken before commissioning any new signal. The Signal sighting committee shall be nominated by the Engineer.
 - (iii) Location of signals shall be worked out as per the requirement of chapter XXII of IRSEM (Special Requirement of Signalling in 25 KV

AC electrified area), 2x 25 KV AC AT feed system of DFC, 25 KV AC traction system of nearby IR and DFC Schedule of dimensions for Eastern Corridor. The Signal shall be located beyond electrical clearances. Suitable iron screening shall be provided if electrical clearances are not achieved.

- (iv) All mountings on signal post viz. Shunt signal, 'Calling ON' signals, 'A' and 'AG' marker lights of Semi-Automatic signals shall be done using separate brackets of suitable size for each of them.
- (v) Signals on posts shall be equipped with a ladder enabling access to the LED Signal lighting units as well as Shunt signal, Calling 'ON' signal and 'A' marker, 'AG' marker lights mounted on the post.
- (vi) Emergency sockets shall be installed on the Signal posts under PS - Telecommunications Works, Vol. 4, Part 2.
- (vii) In case Signal units are required to be mounted on gantry, the Contractor shall submit a suitable gantry design clear of SOD of DFCC Eastern Corridor & electrical clearances and amenable to maintenance for the approval of the engineer. Working instructions for maintenance of gantry mounted signals shall be suitably incorporated in the maintenance plan. Special tools, test equipment including access ladders and protective gear needed for maintenance of these gantry mounted signals shall also be supplied.
- (viii) Suitable Earthing arrangements shall be provided for all signals.

(3) Foundations for Signals

- (a) All Signals shall have concrete foundations having a minimum grade of M20.
- (b) The foundations must be dimensioned sufficiently for Main signals on posts, and independent shunt signals.
- (c) The height of the foundations must be adjusted to the geographical situation (slope, etc.) and to the location of the signals.
- (d) The height of independent Position Light Shunt signal shall not exceed a maximum limit that may infringe the SOD of IR and Eastern Corridor of DFCC.
- (e) The foundation drawings of Main signal and Position Light Shunt Signals (Independent) shall be proposed by the Contractor and approved by the Engineer.
- (f) Suitable pre-fabricated assembly units of reinforced concrete may be used with the approval of the Engineer. In this case, the foundation must have one or several eyebolts for transport purposes. They must be closed after final mounting.

3.2.3 Interlocking

(1) General

The principles of interlocking as per IRSEM shall be followed while designing the Signalling system.

(2) System requirements

- (a) Each Station control area including adjacent block sections shall have a high integrity electronic interlocking suited to work with a Control terminal for Signalling control.
- (b) The Electronic Interlocking equipment shall be housed in Signal Equipment Rooms (SER) at the Stations and in the Block Sections. The number and size of Electronic Interlocking and their locations shall be determined by the Contractor's design.
- (c) Wherever interlocking equipment (Central Interlocking Unit or Object Controller) is located, a display shall be available showing the state of the railway under control by that interlocking and up to the neighboring control area on both sides. The display shall be provided in all the Signalling Equipment Rooms at Stations and in Block section Auto location Huts where Interlocking Equipment (Central Interlocking Unit or Object Controller) is located. Whereas the display at all interlocking Equipment (Central Interlocking Unit or Object Controller) will cover only area under control of that interlocking, the display at Station interlocking shall cover complete block section stretches up to the next (adjacent) station on both sides.
- (d) The Interlocking shall be provided with a data recording system allowing all interlocking states to be time stamped and recorded. The recorded data shall be available to the user for analysis through a suitable PC interface.

(3) Technical requirements

- (a) The Electronic Interlocking (EI) shall be as per RDSO specification RDSO/SPN/192/2005 or RDSO/SPN/203/2011 and procured as per Para 5.2 of this Particular Specifications for Signalling Works.
- (b) Separate I/O Cards shall be used for UP & DN lines for improved functionality.
- (c) It shall be capable of interfacing with TMS and TPWS systems using serial/Ethernet/OFC ports.
- (d) The System design shall ensure that required integrity of safety related vital information is maintained during communication between EI and EI/Object Controllers and between EI and TMS at OCC. In this regard, the requirements for transmission of vital safety information, as laid down in RDSO/SPN/144/2006 and EN 50159 shall be followed.
- (e) The EI Processor shall have sufficient capacity to handle, without any degradation, the load of additional I/O when added in future utilizing available spare provisions as indicated at Para 3.2.3(4)(f).
- (f) Interlocking input and output circuits and associated interface cabling shall be suitable for use within 2x25 KV AC AT system environment and shall be suitably protected against transient and high voltage discharge interference.
- (g) All the Electronic Interlocking shall be connected through duplicated self-healing fail safe OFC rings for transfer of vital data among EI systems. The connection shall be such that full network protection against single Fibre failure is available with seamless switchover between the redundant OFCs. The Contractor shall use dark fibres, exclusive for Signalling use.

(4) Interlocking Design

- (a) The Alignment Plans and Yard plans have been provided under Part 4 – Reference documents. These shall be reviewed and revalidated by the Contractor from Signalling & Interlocking point of view.
- (b) Based on the approved Yard plans, the Contractor shall prepare the Signal Interlocking plans (SIP) and the Control Tables for the Stations and Block sections. The SIP and Control Tables shall be prepared in accordance with Interlocking principles provided for in the IRSEM.
- (c) The approved SIP and the Tables of Control shall form the basis for the design of Signalling system.
- (d) The interlocking shall be designed with a hot standby capability.
- (e) EI system shall ensure the compliance of provisions of IRSEM, including the following:
 - Route Locking after Route setting;
 - Route holding when train passes through the route set;
 - Approach locking after route cancellation when train approached the set route (including gate signals); and
 - On all legitimate routes, the conditions and the signal aspects shall be laid down in the Interlocking Table/chart.
- (f) The system shall have provision for accommodating additional 25% of the I/O used, as minimum spare provision, including corresponding processor capacity for future use.

(5) Mid-Section Semi-automatic Signal

Mid-section modified semi-automatic signal in each direction in New Khurja - New Boraki block section shall be provided as per Indian railways General Rules referred at Para 3.2.1(2) above. The mid-section semi-automatic stop signal SPT (Signal Post Telephone) design, as approved by the Engineer, shall only be provided by the Contractor. The following system of working shall be implemented:

- (i) the mid-section modified semi-automatic stop signal so provided shall be interlocked with the signals of the station ahead through axle counters and shall be controlled by the Station Master of the station ahead, the relevant indications whether the signal is in normal automatic mode or modified semi-automatic mode shall be available to the Station Masters at both the ends;
- (ii) Advanced starter signal of the station in rear shall be interlocked with the mid-section modified semi-automatic stop signal in such a way that when working with 'A Marker extinguished, the Advanced starter shall assume 'off' aspect or be taken 'off' only when the line is clear upto an adequate distance beyond the mid-section modified semi-automatic stop signal; similarly the mid-section modified semi-automatic stop signal shall assume 'off' aspect automatically or be taken 'off' only when the line is clear upto an adequate distance beyond the Home signal of the station ahead;
- (iii) During abnormal conditions like fog, bad weather impairing visibility, the mid-section modified semi-automatic stop signal may be worked by

extinguishing 'A' marker in the manner prescribed under special instructions and this action shall also ensure that the 'A' marker of the Advanced starter signal of the station in rear and Home signal of the station in advance shall also be extinguished;

- (iv) During normal conditions, mid-section modified semi-automatic stop signal shall work as normal automatic stop signal;
- (v) When the Loco Pilot finds mid-section modified semi-automatic stop signal with 'A' marker extinguished in 'on' position, he shall stop his train in the rear of the signal and inform this fact to the Station Master of the station ahead on approved means of communication as prescribed under special instructions; and
- (vi) The Station Master of the station ahead may authorise the Loco Pilot to pass the mid-section modified semi-automatic stop signal working with 'A' marker extinguished in 'on' position through approved means of communication after ensuring conditions and procedure prescribed under special instruction.

3.2.4 Control system

(1) System requirements

- (a) For reasons of operational availability, a distributed control capability is required on the section.
- (b) There shall be a Control terminal in Hot Standby mode provided at Station with the Station Master. There shall be no Control terminal in the Block section. The Control terminal provided with the Station Master at the Station shall be used to control the Station yard and block section (part or complete), under control of the said Station Master. The display on the Control terminal shall however, include not only the current state of railway under control of the Station Master, but shall also include further display for the complete block sections up to the adjacent stations on both sides. The complete display shall be available on the Control Terminal without scrolling. Multiple terminals shall be used, as required for proper display.
- (c) The Control terminal shall have hard SM key/ smart card or login facility to authenticate the operator for operation and transfer from one Control terminal to another.
- (d) Diagnostic functions shall not be operative from the Station Master's Control Terminal.
- (e) Signalling control shall be available on only one Control Terminal (Main or Standby) at a time, to avoid conflicting control commands.
- (f) Route Locking, route holding and all locking of signals as well as points and crossings shall not be affected if there is a transfer of control from one Control terminal to another.
- (g) The SM shall have facility to put back any signal (including automatic signals) under his control to ON position.
- (h) Certain operations are regarded as safety critical and shall require two stage commands, such as, latched key, simultaneous operation with more than two (02) switches or buttons, or co-operated operation by two persons or suitable commands through Control Terminal. Following are some

examples of safety critical operations:

- Route Cancellation.
 - Point machine Crank handle release.
 - Point operation under Track section failure.
 - Resetting of Axle Counter.
- (i) The contractor shall prepare and submit list of such safety critical operations derived from an analysis of the system, along with the proposed two stage command protocol for the Engineer's review and acceptance.

(2) Technical requirements

- (a) The Control terminal shall be provided with full redundancy (1+1) in hot standby mode. When changeover takes place, it should be ensured that requirement of 3.2.4(1)(e) & (f) continue to be met.
- (b) The Control terminal shall have a latest industrial grade embedded fan less PC with no external drive, colour VDU monitor with minimum size of 32".
- (c) The Software of Control terminal shall be validated to SIL-2. All safety critical functions shall be compliant to SIL4.
- (d) The Control terminal shall be connected to EI on duplicate cables, preferably OFC laid through diverse routes.
- (e) The Control terminal shall work on 230V \pm 10%, 50 Hz AC power supply. It shall be provided with power back up of 4 hours either through UPS/IPS of the Station Signalling system or by providing a separate UPS system.

3.2.5 Track Vacancy Detection System

(1) System requirements

- (a) Track-vacancy detection shall be continuous, provided in the Block sections and at the Station, on all the lines, including berthing portions of sidings at the station.
- (b) The track vacancy detection technique shall use Digital Axle Counter technology as a primary means of train detection. Where required, a secondary means of track vacancy detection can be used to supplement the primary means with the approval of the Engineer.
- (c) The presence of trains and vehicles shall be positively detected, under all modes of system operation. However, Light vehicles like push trolley, dip lorry and the rail dolly etc. which are being used on Indian Railways, shall not affect the functioning of the DAC.
- (d) The tolerance of detection accuracy for detecting the position of the vehicle/ train shall be such that safety is maintained, operational requirements are fulfilled and fouling marks are not infringed, under worst-case conditions.
- (e) The location of the Evaluator, vital relays & other MSDAC equipment and their cabling & power supply requirement shall be determined by contractor's choice of equipment and design.
- (f) The contractor should comprehensively detail the impact of system failure on train detection and the impact on train detection once the failure is restored.

- (g) At the boundary with adjacent section of EDFC, the track vacancy detection system provided shall achieve no loss of continuous detection at any point of time.

(2) Technical requirements

- (a) The Track-vacancy detection system, including Main and Supervisory system shall be designed to meet the requirements of SIL 4 as defined in IEC 61508.
- (b) Track-vacancy detection at the station and in the block sections shall be Multi Section Digital Axle Counters (MSDAC) as per RDSO specification no. RDSO/SPN/176/2013 and procured as per Para 5.2 of this Particular Specifications for Signalling Works.
- (c) Single Section Digital Axle Counter (SSDAC) as per RDSO specification no. RDSO/SPN/177/2012 and procured as per Para 5.2 of this Particular Specifications for Signalling Works shall be provided on lines that are provided with Absolute block working.
- (d) The detection system shall be suitable for use with UIC 60 Kg. rail.
- (e) When the Signalling system starts after long duration power failure, all track sections shall show occupied until reset by the Station master(s).
- (f) Track devices on crossovers /points shall be provided considering Flank Protection.
- (g) The track-vacancy detection system in New Khurja – New Boraki block section and Up and Down lines connecting New Boraki Junction Station to Point zone controlling movement to/from Dadri ICD yard-Dadri area shall have Main system and Supervisory system. The Main and Supervisory systems shall be provided on different rails. The Supervisory system shall have a track section for every two Main system track sections. The purpose of providing the Supervisory system is to enable smooth operation by avoiding manual resetting during failure of a track section. In case the track section(s) of the Main system fail(s) with its corresponding track section of the Supervisory system showing clear or vice versa, it will automatically reset the failed track section(s). A typical scheme for Track vacancy detection system using MSDAC in Automatic Block Section is placed at Appendix 4.
- (h) The track-vacancy detection system at New Boraki Junction Station shall have only Main system with no Supervisory system.

(i) Detection Points and Track sections

- (i) In order to minimize the number of track sections in Automatic Block Section, no separate track section shall be provided for overlap portion. A single track section shall include the route as well as the overlap of the signal. Thus, one track section will overlap the adjacent track section in the signal overlap portion. This shall be applicable for Main system as well as Supervisory system, where used.
- (ii) The Supervisory system, where used shall be provided on different rails from the Main system and shall not have any common DP with the Main system. Each supervisory track section shall cover not more than two track sections.

- (iii) At the boundary with adjacent section of EDFC, the DP of the last track section shall be so located that the track section overlaps with the track section of the track vacancy detection system of the adjacent section. The distance between the two adjacent DPs shall be sufficient not to cause any interference between the two systems.
- (iv) The detection points attached to the rail must be protected by means of deflectors against mechanical damage that can be caused by parts of running trains.

(j) Evaluators

- (i) Separate Evaluators shall be provided for UP and DOWN lines.
- (ii) The Supervisory system, where used, shall have a separate Evaluator from the Main system.
- (iii) Spare sets of CPU card(s) fully programmed and configured shall be provided for each Evaluator and kept ready for replacement. This shall be over and above the 'Contract Spares' provided under Para 10.2.7 of this specification.

(k) Communication

- (i) The transmission between Central Evaluator and Field units of UP and DN systems shall be in separate cables, preferably of different kinds, say OFC and quad.
- (ii) The transmission between Central Evaluator and Field units of Main and Supervisory systems shall be in separate cables, preferably of different kinds, say OFC and quad.

(l) Resetting Arrangement

(i) Manual Resetting

- a. A suitable resetting scheme shall be designed by the contractor for manual resetting of axle counter track sections at station and block sections. This shall be achieved through a mix of system design and the operating procedures. The scheme should avoid, to the extent possible physical verification of track at site, without affecting safety.
- b. The scheme, as far as possible, shall make use of Station Master's Control terminal for resetting operations.
- c. Provision shall be made to record every operation of resetting by non-resettable counter. The counter shall count, every time the resetting is done and shall not reset back on failure of control terminal /power supply.
- d. Preparatory reset of a track section shall not disturb other track sections in any way.

(ii) Automatic Resetting in Automatic Block section

When any track section of the Main system fails with its Supervisory track section showing clear, then the failed track section should get automatically reset. Similarly, when the Supervisory track section fails with both track sections of the Main system supervised by it showing

clear, then the failed Supervisory track section will get automatically reset. This shall considerably reduce the occasions for resorting to manual resetting & will help smooth train operation.

(3) Installation and Entry into Service

- (a) The trackside equipment shall be installed on that side of the track, which is less dangerous for maintenance staff. It should not be installed between the main line tracks.
- (b) The requirement of track maintenance machines (mechanized) shall be taken into account while installing outdoor equipment. Trackside Equipment installations shall be agreed with the Engineer prior to installation to avoid conflict with track maintenance machines.
- (c) Where feasible, the trackside equipment shall be housed in sturdy lockable location boxes as an anti-theft measure. Additional anti-theft measures shall be proposed by the Contractor and approved by the Engineer at the time of installation.

3.2.6 Points and Points machine

(1) System requirements

- (a) On the EDFC system, modern turnouts and derailing switches are programmed to be used. The turnouts will be on 60 Kg rail, with thick web switches and weldable CMS crossings suitable for 25 tonne axle load and Speed potential of 100 Kmph on Main lines.
- (b) The points laid in the various yards of the DFCCIL by the CST contractor shall meet all the requirements set out in paragraph 12.40 of Chapter XII of the IR Signal Engineering Manual for which the contractor shall interface with the CST contractor.
- (c) The indicative list of items for which the contractor shall be required to maintain Interface with the CST contractor of CP 302, is given in Chapter 11 of this Particular Specifications.
- (d) All the points shall be worked with Electric Point machines.
- (e) It shall be possible to operate trains through all points and crossings in all directions of travel. Loss of electrical power shall not cause a change of physical point status and the points shall remain locked in the last operated position.
- (f) The Point machines and the ground connections supplied by the Contractor shall be compatible with turnouts and derailing switches provided by the CST contractor. The contractor shall interface with the CST contractor for the same.
- (g) Point machines supplied shall be simple in operation and shall require minimum maintenance. They shall be small compact units, readily accessible and interchangeable.

(2) Technical requirements

- (a) Non trailable Electric Point machines shall be as per specification IRS S 24-2002 and procured as per Para 5.2 of this Particular Specifications for Signalling Works. The Point machines shall be provided with external Clamp locking arrangement.

- (b) Provision shall be made for individual manual operation of each point. Electrical Power shall get disconnected from the point drive under manual (crank handle) operation. Crank handles used for manual operation of point shall be interlocked such that removal of crank handle shall prevent setting of relevant routes. The number of crank handles shall be minimized by suitable grouping such that the impact on operations is minimal when the key is taken out.
- (c) Point detection shall be provided to detect that each switch is positioned with sufficient accuracy to ensure safe travel through the point before authorizing a train movement over the point. The limits of Obstruction Test shall be as per the requirement of IRSEM.
- (d) Where the points form a crossover, independent detection shall be provided for the points at each end of the crossover. The two independent detections can however, be proved together and read into EI as a single input.
- (e) The relative position between the point machine and the stock rail shall be fixed such that independent movement is prevented.
- (f) The super imposed detection is not permitted.
- (g) Locking detection shall be provided to detect that the point lock is in the respective locked position before authorizing a train movement over the point.
- (h) Provision shall be made for emergency operation of points during track section failure. Each such operation shall be recorded by a suitable counter.
- (i) All point operating equipment and point operation & detection circuits shall be totally immune from traction current effects or other EMI sources.
- (j) Point machine wires shall be protected to prevent short-circuiting and monitored continuously for earth leakage.

(3) Point machine Installation

- (a) Point machines installed shall present a minimum hazard to people walking along the track.
- (b) Point machines shall be installed beside the close switch leading to high speed movement clear of all infringements.
- (c) No point machines shall be installed in between the main line tracks.
- (d) The point machine cover shall be provided with secured locking mechanism.
- (e) The point machine shall be installed as per RDSO/OEM checklist.

3.2.7 Relays

- (1) The various types of relays used in interlocking systems shall comply with IRS specification no. S34 and the requirements of IRS, BS or BRS specifications or any other specifications as approved by the Engineer.
- (2) Time element relays electronic type conforming to IRS/BS/BRS or of the specification approved by the Engineer shall be used. When electronic time element relays are used these shall be two in number and their contacts should be in series with each other.

- (3) The relays shall be preferably of the plug-in type. The Contractor shall seek the advice of the Engineer in case other than plug-in-type relays are proposed to be used.
- (4) All plug-in Relays and relay groups shall be fitted with non-interchangeable Relay Bases to prevent the wrong relays/relay group being accidentally plugged in during replacements.
- (5) Removal or replacement of plug-in relays/relay groups during operation shall not cause any unsafe conditions in the circuits.
- (6) All relays shall, to the extent possible be housed in the Signalling Equipment room.
- (7) All relays shall have minimum 10% of working contacts as spare subject to a minimum of one front and one back contact.
- (8) The use of relays within the signalling sub system shall, however be minimised by design.

3.2.8 Power Supply

- (1) The Contractor shall be responsible for providing the power supply for all the Signalling and Telecommunication equipment provided under the contract.
- (2) The power supply scheme for Signalling and Telecommunication System should be based on 230V 50Hz AC supply.
- (3) This 230V supply will be provided by the Contractor under Particular Specifications - 2x25 kV AC Traction Electrification and Associated Works, at all places except OCC. At OCC, the 230V supply will be provided under CP - 104. At OCC, the Contractor of CP - 104 will provide a LT panel in which he will make available the 230V power supply for the Signalling and Telecommunication system. The Contractor shall make arrangements to draw the 230V power supply required for Signalling and Telecommunication equipment provided by him under the contract.
- (4) The Contractor of CP 104 will also provide a UPS as per specification at Appendix 1 for Signalling and Telecommunication Equipment provided in OCC under CP 104. The responsibility for providing Power supply for additional equipment being provided under the Contract in OCC, lies with the Contractor. The Contractor can meet its contractual obligation by either providing new power supply or by suitable addition/augmentation of the Power supply provided under CP 104. The Contractor shall coordinate with the Contractor of CP - 104 for the same.

At locations other than OCC, the Auto Change over Switch (ACO) shall be provided by the Contractor under Particular Specifications-2x25 kV AC Traction Electrification and Associated Works, near/inside the S&T Power Supply Equipment room on which the power supplies from various sources viz. UP AT, DN AT, Local supply, DG set (as applicable) will be terminated. The Contractor shall take the Power supply from ACO to the main AC distribution panel/box common for Signalling and Telecommunication system on two independent power cables laid through diverse routes.

- (5) The Contractor is required to create MCB protected 230 V, 50 Hz supply for the Signalling and Telecommunication system with sufficient capacity plus an additional 30% spare capacity for future expansion to meet the system design requirements.
- (6) The Power Supply for Signalling system shall be drawn from Main AC Distribution Panels/Boxes and terminated on Signalling AC Distribution Panel/Box from where

it shall be distributed to all Signalling Equipment/Signalling Power Supply Equipment operating at 230 V AC.

- (7) The Contractor shall carry out a detailed power supply calculation for total Signalling load (including load of battery charging in boost mode) of every Station/ Auto Location etc. and depending on the load requirement at each location, an Integrated Power Supply (IPS)/Uninterrupted power Supply (UPS) system of appropriate capacity shall be provided.
- (8) All design loadings and calculations are subject to acceptance and approval by the Engineer before installation commences.
- (9) The IPS provided shall be as per specification RDSO/SPN/165/2012 and procured as per Para 5.2 of this Particular Specifications for Signalling Works. The supply to different Signalling equipment say Electronic Interlocking, Digital Axle Counter, Relays Internal, Relays External, Point Machine, Data Logger, VDU, Block Panel etc. shall be separate, provided using separate set of additional power supply equipment with minimum N+1 redundancy. The additional power supply equipment shall be in accordance with IRS/RDSO specification (if any)/ relevant international standards.
- (10) The battery backup shall be provided with VRLA maintenance free cells as per specification IRS: S 93/96(A) of suitable capacity and procured as per Para 5.2 of this Particular Specifications for Signalling Works. Battery bank shall have adequate capacity to provide a backup time of minimum 4 hours with maximum depth of discharge of the battery as 70%. The batteries shall be installed on battery racks.
- (11) Four numbers of 2V Cells and a spare Cell charger for charging up to 6 cells at 10% of battery AH capacity shall be provided as spare at each power supply location with the main supply.
- (12) Restoration of the primary supply shall cause a seamless changeover from the IPS/UPS back to the primary supply.
- (13) The Contractor shall sectionalize the power feeds to logical groups of equipment to allow for ease of maintenance and to enable maintenance to be carried out without disturbing the operation of other equipment groups.
- (14) All Signalling equipment local supplies shall use redundancy techniques (ring circuit) to provide appropriate availability. The design of the distribution shall ensure that a technician can isolate the power feed to an item of equipment without affecting the operation of other equipment/items connected to the ring.
- (15) An external bypass facility shall be incorporated in all IPS/UPS battery power supplies to cater for maintenance and failure requirements.
- (16) Automatic monitoring of battery condition and charge state shall be provided as per Para 3.2.9 of this specification.
- (17) All feeding voltages shall be monitored continuously by voltage sensors. In addition all non-earthed output supplies shall be monitored by earth leakage detectors. The said monitoring shall be possible from Service & Diagnostic (S&D) terminal at the station and OCC for which necessary sensors and interfaces shall be provided.
- (18) Any failure of power supply equipment shall be recorded and displayed on the Control terminal at the Station and S&D terminal at the Station and in the OCC.

- (19) Notwithstanding anything contained in this specification, the contractor shall be fully responsible for proper working of Signalling power supply system.

3.2.9 Service and Diagnostic (S&D) System

(1) General

- (a) A Service and Diagnostic (S&D) system shall be provided for monitoring and supervision of health of signalling equipment to be provided under the contract, to enable carrying out preventive maintenance of signalling equipment with optimum resources and reduce the MTTR of the equipment.
- (b) The S&D system for the adjacent section - Bhaupur-Khurja, meeting the System and Technical requirements as specified at Para 3.2.9 (2) & 3.2.9(3) is being provided, under contract, CP 104.
- (c) The S&D system for Signalling equipment of Dadri-Khurja section to be provided under the contract shall be of similar specification and shall seamlessly integrate with the S&D system of Bhaupur-Khurja section.

(2) System Requirements

- (a) The S&D system shall be able to predict failure of the equipment, where practicable, based on the deterioration of the parameters being monitored, thereby avoiding a potential future failure of signalling system.
- (b) The S&D terminals shall be provided with the Signal Maintainer at the stations and with Signal fault locator at the OCC. Each Signal Maintainer's S&D terminal shall monitor health of signalling equipment under his area of control.
- (c) The S&D computers shall be able to provide status, fault, and event indications of the signalling assets. With the help of such analysis and the specific fault conditions, the S&D computer shall identify the displayed faults. These faults shall be stored in a data-base. Eliminated faults shall be stored for statistical evaluation at a later stage.
- (d) It shall also be possible to send the alarms in the form of SMS to technicians in the field to facilitate reduced MTTR.
- (e) An electronic maintenance manual shall be accessible via the S&D work station which shall aid maintenance staff in fault diagnostics and rectification. The complete section 'As Made Drawings' shall be loaded in the server in OCC for being accessed by the signal fault controller at OCC.
- (f) All signalling drawings of concerned station and adjoining block section shall be loaded in the S&D work-station of the station in pdf format. In case, such a data is stored at central location, software for easy access shall be provided in the S&D system.
- (g) The S&D system shall immediately report, but not limited to, the following functions:
- Identification of failure of point throwing or detection.
 - Identification of signal defects.
 - Power supply defects including IPS /UPS defects and earth faults.
 - Untimely or out-of-sequence operation of equipment.
 - Unauthorised or potential unsafe train movement.

- (h) Following Typical alarms, but not limited to, shall be generated by the system:
 - (i) Point Machine:
 - (a) Point obstructed.
 - (b) Point machine motor drawing more than normal current.
 - (c) Operating voltage low/high.
 - (ii) Axle Counter:
 - (a) Evaluator Operating voltage low.
 - (b) State of reset.
 - (c) PCB failure.
 - (d) Abnormal movement.
 - (iii) Power Supply System:
 - (a) Presence of Input from AT1 & AT2 on ACO
 - (b) Presence of Output from ACO
 - (c) Input mains voltage beyond limits.
 - (d) Output voltage beyond limits.
 - (e) Working on standby system after main system failure.
 - (iv) Earth Leakage Detector (ELD) for Cable Health Monitoring:
 - (a) Supply leakage occurred time.
 - (b) Supply leakage disappeared time.
 - (c) Linking the events of supply application and withdrawal to cable conductors with ELD alarm.
 - (v) Signalling Equipment Room (SER) Door Monitoring:
 - (a) SER Door opening and closing events.
 - (vi) Block Instrument:
 - (a) State of block section relating with block instrument.
 - (b) Wrong sequencing of block operations.
 - (vii) Battery Monitoring Unit:
 - (a) Cell voltage beyond limits.
 - (b) Battery charging and load currents beyond limits.
 - (c) Each cell temperature beyond limits.
 - (d) State of charge of battery bank lower than the limit set.
 - (viii) Colour light LED Signal:
 - (a) Current drawn beyond range.
 - (b) Signal lamp lit due to faulty voltage.
 - (ix) Surge Protection Devices:
 - (a) Health Status.

(3) Technical Requirements

- (a) The S&D system shall collect the data on the health of signalling equipment – Signal, Point, DAC, Power supply, Battery, air-conditioner etc. using HMUs, general purpose Data loggers and Data Concentrators etc. at Stations, Auto Locations huts, IMD/IMSD etc. Parameters of each signalling equipment /system shall be monitored by monitoring the voltages, currents, potential-free contacts etc., using a general purpose data logger. In processor-based equipment like Axle Counters, Electronic Interlocking etc., the data logger shall collect the diagnostic data through a port from the equipment in soft form. Scanning interval for digital inputs to data logger shall be less than 20 sec and analogue input not more than 1 sec.
- (b) The Service and Diagnostics (S&D) data network shall be established by networking all data loggers using copper quad cable or OFC channels or dark fibre, as appropriate and data of all stations and block sections shall be brought to Signal Fault Controller on OCC on the OFC system provided under PS – Telecommunication works, Vol 4, Part 2. The communication path between data loggers and the OCC shall be provided with redundancy.
- (c) The S&D data network in the OCC shall be built with redundancy of equipment like Front End Processors, Centralized Monitoring Units, LAN Switches, servers etc.
- (d) The S&D terminals shall be provided at various locations viz. Stations, IMD/IMSD, OCC etc., as required to monitor health of all Signalling equipment provided under the contract. The S&D terminals shall be industrial grade PC with a low noise logging printer of the latest technology provided at all stations and at OCC. The size of VDU for S&D terminal shall be of 32 inch.
- (e) The events log shall be automatically backed up by the system with 60 days archive back up. The active storage period is a rolling 30 days period.

(4) Scope under the contract

- (a) Provision of health monitoring system – HMUs for Signals, Points, DAC, Power supply, Battery, air-conditioner etc., Data Loggers, Data concentrators, as required to monitor health of signalling equipment provided under the contract at Stations, Auto Locations huts, Relay Huts, IMSD, IR, WDFC locations etc.
- (b) The S&D terminals shall be provided in the field, as required, to monitor health of all the signalling equipment provided under the contract at locations such as Signal Maintainer at New Boraki station, Signal Maintainer's location in IR's Dadri (ICD)-Dadri area, Signal Maintainer's location in WDFC, Signal Supervisor(s) room in the IMSD. An S&D terminal has been provided with the Signal Fault Controller in the OCC under the contract, CP 104 to monitor health of the Signalling equipment provided under CP 104 contract. The Contractor shall make suitable modifications/additions as required in the OCC S&D system hardware/software provided under CP 104, to enable him use the same S&D terminal as provided in CP 104 to monitor health of complete Signalling system of CP 104 & CP 105 from the OCC.
- (c) Provision of communication infrastructure for carrying the Signalling system health monitoring data in Dadri-Khurja section is covered under PS – Telecommunication works, Vol 4, Part 2. The health monitoring data beyond Khurja to OCC, shall be taken in communication infrastructure being provided by another contractor, CP 104. The Contractor shall, however be required to undertake suitable

modifications/additions to CP 104 communication infrastructure to achieve the same.

- (d) The Data processing and analysing system at OCC for Bhaupur-Khurja section is being provided under CP 104 as per Para 3.2.9 (3) above. The contractor shall use the same system to process and analyse data of health monitoring system of Dadri-Khurja section provided under the contract. The Contractor shall undertake suitable modifications/additions to the system provided under CP 104 to achieve an integrated S&D system for Bhaupur-Khurja-Dadri section.
- (e) The Contractor is responsible for arranging power supply for S&D system being provided under the contract. The Power supply shall be provided as per Para 3.2.8 of this Particular Specifications for Signalling works.

3.2.10 Train Management System

- (1) An Operations Control Centre (OCC) is being constructed at Allahabad under another Contract, CP-104. The OCC shall house the Train Management System (TMS) and Traction Power SCADA for the entire Eastern Dedicated Freight Corridor, including for the section Dadri-Khurja to be provided under the present contract (Contract Package CP-105).
- (2) The Train Management System of CP-105 shall be provided by extending the Train Management System (TMS) of adjacent section, Bhaupur-Khurja Section of EDFC -1, being provided under Contract Package CP-104. The design of TMS system of CP- 105 shall be fully compatible with the TMS system being provided for Bhaupur-Khurja section of Contract Package CP-104 in all respects.
- (3) The Contract for Signalling Works, including the TMS for Bhaupur-Khurja section (CP-104), has been awarded and the work is in progress. The Technical specifications for the TMS system to be provided in Bhaupur- Khurja section is detailed in Appendix 7.
- (4) The TMS of Bhaupur – Khurja section will be a computer based information storage cum retrieval system located in the Operational Control Centre (OCC) at Allahabad. The system shall be suitably extended/upgraded by the Contractor to collect and display signalling information of the CP 105 sections, New Khurja – New Boraki – Dadri (ICD) - Dadri area & New Boraki – WDFC on real time basis.
- (5) In the TMS, no control over the signalling system shall be implemented from the OCC. All functions viz. route setting, point control, signal clearance etc. shall be performed at the Station Master level. However, The TMS provided shall have all capability built in to be upgraded at a later stage for use as Centralized Traffic Control (CTC) with minimum changes and add-on equipment.
- (6) The TMS system in OCC shall provide functions such as Remote indication of signalling equipment status, Train Describer System, Monitoring the health of the signalling system, Event Log and Storage and compilation of statistics etc.
- (7) The Wayside Communication Equipment with redundancy shall be provided at Electronic Interlocking of CP 105, for meeting communication requirements between Wayside Electronic Interlocking and Servers at OCC. 20 % of the slots used for fixing I/O and peripheral cards in these Wayside units shall be kept spare for future expansion. These Wayside communication equipment shall be fully compatible with the TMS system of CP-104. The communication system for transmission of TMS data from station to OCC and IMSD shall be provided under PS-Telecommunication works, Vol. 4, Part 2.

- (8) A Video Wall display Panel in the form of a large wall display is being provided in OCC for CP-104 with track diagrams of all stations/yards and block sections of CP-104 displaying status of track section, points, aspect of signals, route set indication etc. in real time to provide controllers with an overview of the complete system. A Video Wall display Panel for SCADA of CP-104 is also be provided by CP-104 contractor.
- (9) The Contractor shall extend the TMS display of CP 104 to include sections of CP-105, by providing new Video Wall Display Panels, of similar specification as provided in CP 104. The detailed specifications for Video Wall Display being provided in CP 104 can be seen in Appendix 7. The Contractor may provide the Display on the new Video panels either by providing new hardware-software or by modification/upgradation of hardware, software being provided in CP – 104, the details for which are given in Appendix 7.
- (10) The Video Wall Display System for SCADA System shall also be provided by the Contractor. It shall take the inputs for real time indications from the SCADA System being provided under Particular Specifications – 2x25 kV AC Traction Electrification and Associated Works. The Contractor shall suitably interface with OHE SCADA to achieve following information exchanges between TMS & SCADA.
 - (a) TMS will take OHE shut down reports from OHE SCADA system.
 - (b) TMS will take details of the various power block granted and their duration from SCADA system.
 - (c) TMS will take details of OHE failures and tripping details of FP, SP, and SSP.
 - (d) SCADA will pick up train ID details from Train Describer system of TMS.
 - (e) SCADA will pick up failure of AT supply details from TMS to organize restoration of failed AT supply.
 - (f) Any other information considered necessary by the Engineer.
- (11) The Contractor is responsible for arranging power supply for TMS system being provided under the contract. The Power supply shall be provided as per Para 3.2.8 of this Particular Specifications for Signalling works.
- (12) The TMS Servers provided at the OCC for CP–104 has the following software which needs to be suitably upgraded to cover the sections of CP–105:
 - (a) Management Information System (MIS).
 - (b) Plotting & Display of Train Graph.
 - (c) Training & Simulation System.
 - (d) Crew Management System.
 - (e) Time Table Planning and Management (off line).
 - (f) Event Log and alarm system with replay facility.
 - (g) Train Describer System.
 - (h) Data base Management.
 - (i) Fault Diagnostic and Display system and

- (j) User's system Management.
- (13) The Timetable Management system and Crew Management system being provided under CP 104 is also to be used by TMS of other sections of EDFC. The data of these systems provided on the Central Servers of TMS provided under CP 104 shall be suitably upgraded to include the information pertaining to new section CP 105.
- (14) The basic application data input to the TMS System of CP-105 shall be same as that for CP-104, the details of which are given in Appendix 7.
- (15) All cables of the TMS and associated accessories to be provided under CP 105 shall be the same as for CP104, the details of which are given in Appendix 7.
- (16) The Man-Machine interface provided under the contract shall be similar to the one provided under CP 104, in all respects.
- (17) The requirement of system administration, shock and vibration and electromagnetic compatibility shall be same as for CP104, the details for which are given in Appendix 7.
- (18) The Contractor shall make suitable arrangements to earth all additional equipment at all locations including OCC, station, lobbies etc. for EMC/EMI protection. The Earthing design shall be got approved by Engineer. The Earthing shall be maintenance free. The Earthing value shall not exceed 1 ohm.
- (19) The Functional requirements of the TMS of CP-104 are detailed in Appendix 7. The TMS extended/upgraded to include sections of Contract CP-105 should continue to meet all the functional requirements.
- (20) The Technical requirements of the TMS of CP-104 are detailed in Appendix 7. The Hardware and Software used to extend/upgrade the TMS of CP 104 to include sections of present contract (CP 105) should continue to meet all the Technical requirements.
- (21) The System architecture, expandability, component grade, design life, flexibility, standard systems, EMI/EMC immunity, fault tolerance, man machine interface, system clock etc. features shall be strictly in accordance with the system requirements of TMS of CP-104 as detailed in Appendix 7.
- (22) The Performance requirements of the TMS as detailed in Appendix 7 will be applicable.
- (23) The manufacturer shall supply the following sets of documents. Guidelines contained in GS and PS on documentation shall be followed.
- (a) User manual: This Manual is meant for users of TMS explaining basic operation of data entry, data recording, generation of reports etc.
- (b) Operator manual: This manual is meant for System operator, who manages the system, controls individual operators, generates authorization, and supervises the functioning of system.
- (c) Programming manual: This manual is meant for Technical staff and will be used for programming the changes in display, incorporating changes in name of station, yard layout change, adding and deletion of new station, addition and deletion of new controllers etc.

- (d) Service/trouble shooting Manual: This manual is meant for technical staff and will be used to attend the various failures and troubleshoot the fault. The manual shall guide step by step to arrive at the exact fault.
- (e) Maintenance cum Technical manual: This manual is meant for technical staff and guides step by step for carrying out the various periodical & preventive maintenance checks and backups to be taken to prevent loss of data/software.
- (f) Schematic installation drawings: These drawings indicate the various arrangements of TMS like various controller terminals, its layout, inter connections of the terminals, arrangement of LAN, configuration of equipment, the equipment installed at various locations etc.
- (g) Installation, operation & maintenance manuals: These shall be supplied as per details given in GS/PS.

(End of Chapter 3)

CHAPTER 4: PERFORMANCE REQUIREMENTS

4.1 SYSTEM PERFORMANCE

- 4.1.1 The Signalling system shall be designed as per provisions of Employer's requirements, for a speed potential of 100 KMPH on the main line, keeping 10% safety margins.
- 4.1.2 The Contractor shall carry out to the satisfaction of the Engineer, the Simulation and other Performance tests to demonstrate the System Safety and Operational performance, including available 'Headway.'
- 4.1.3 The Reliability, Availability, Maintainability, Safety (RAMS) activities during the apportionment of system requirements, design and implementation, manufacture, integration, system validation, system acceptance and operation and maintenance during defect notification phases shall meet the requirements of CENELEC standards EN50126, EN50128 and EN50129 with latest amendments. The system phase related tasks to be carried out by the Contractor for these phases are highlighted as under:

4.2 RELIABILITY, AVAILABILITY, MAINTAINABILITY (RAM)

- 4.2.1 The Signalling system shall achieve all RAM requirements specified in GS and this PS.
- 4.2.2 The Employer attaches great importance to the attainment of the highest possible reliability during service of all the equipment and systems supplied and installed under this contract. The design, manufacture, installation and commissioning of the equipment and also the training of the operating and maintenance staff shall be such as to ensure near Zero Failure performance in the initial stages and that the few defects and deficiencies that may be exposed during the Service Trial are totally eliminated.
- 4.2.3 All the sub-systems and equipment to be used for this system shall be of proven design, in use on other similar railway projects and reliability in accordance with RAMS standards.
- 4.2.4 The sub-systems and equipment shall be engineered to maximize system availability during traffic hours in accordance with RAMS standards, to minimize the amount of maintenance required and to ensure that any maintenance can be easily and quickly carried out in minimum time.
- 4.2.5 Fault Tolerance & Graceful Degradation: The system shall be designed such that service can be maintained in the presence of faults. Subsystems and components whose failure can significantly impact on RAM performance shall be backed up by simpler sub-systems or components that permit continuous operation.
- 4.2.6 Recovery: Provision shall be made to recover from any credible fault while minimizing disruption to service.
- 4.2.7 Condition Monitoring & Diagnostics: Diagnostic systems shall be used to detect, or where practicable, anticipate faults. Such systems shall be used to reduce requirements for preventive inspection and maintenance, to reduce overall costs, and improve reliability.
- 4.2.8 The Contractor shall submit system Reliability, Availability and Maintainability (RAM) Plan for review and approval of the Engineer.

4.3 RELIABILITY MODELLING

- 4.3.1 The Contractor shall perform Reliability and Maintainability analysis of each system, up to the point of interface with other systems.
- 4.3.2 The Contractor shall develop an evolving Reliability model consisting of Reliability Block Diagrams (RBD) and probability of success equations. This model shall show the relationships required for system and equipment to operate successfully. The RBD shall include multiple Electronic Interlocking and Track Vacancy Detection Systems that will be implemented for this project. The RBD shall also include all elements essential to the successful performance of the system and the interrelationships and interface of these elements. The model shall not reflect the degraded mode of operation. The Contractor shall revise the RBD model to keep current with design iterations.
- 4.3.3 The reliability model consisting of reliability block diagrams and probability of success equations shall be developed and submitted to the Engineer for acceptance.
- 4.3.4 Reliability apportionment and prediction analysis shall be in accordance with established techniques or standards, or properly documented and verifiable field failure data for identical or similar equipment. The standards used or the source of field data shall be identified.
- 4.3.5 The Reliability apportionment and prediction analysis shall be carried out in parallel with the design of the system. The relevant apportionment and prediction figures shall be part of the design submission documents for the individual equipment, sub-system and system.

4.4 FAILURE DEFINITIONS

- 4.4.1 The inability to perform a required function, the occurrence of unexpected action by the equipment, or the degradation of performance to below the required specifications shall constitute a failure.
- 4.4.2 Relevant Failure: A relevant failure of an item is an independent failure which results in a loss of function of that item caused by any of the following:
- (a) A fault in an equipment or sub-system while operating within its design and environmental specification limits;
 - (b) Improper operation, maintenance, or testing of the item as a result of the Contractor supplied documentation.
 - (c) Failures of transient nature including those with post investigation status as 'No fault found', shall be considered as relevant failure if in the opinion of the Engineer these are attributable to Signalling System.
- 4.4.3 Non-relevant Failure: Any failure of an item not included in the definition of relevant failure, such as the following:
- (a) A failure caused by malfunction of other equipment or sub-system that are not supplied by the Contractor.
 - (b) A failure caused by human error, except as noted in Relevant Failure above;
 - (c) A failure caused by accidents not associated with the normal operation of the item.
 - (d) A failure caused by operating the equipment or sub-system outside of design or environmental specification limits.

4.4.4 Service Failure: Any relevant failure or combination of relevant failures during revenue service operations to determine availability for revenue service, which results in one of the following:

- (a) Delay to train service;
- (b) Fault preventing a train from entering service at its scheduled time.

4.4.5 Pattern Failure: The repeated occurrences of 3 or more relevant failures of the same replaceable part, item or equipment in same manner in identical or equivalent applications when they occur at a rate which is inconsistent with the predicted failure rate of the part, item or equipment will be termed as pattern failure.

4.5 RELIABILITY REQUIREMENTS

4.5.1 Reliability requirements and goals shall be developed in terms of Mean Time Between Service Affecting Failures (MTBSAF)/Mean Time Between Failure (MTBF).

4.5.2 The reliability requirement is subsidiary to the Availability and Maintainability requirements as specified in this PS. If higher figures are required to achieve the Availability requirements then these higher figures shall become the reliability requirements for Signalling system.

4.5.3 The Signalling System shall be fault tolerant such that if failure of any sub-system is likely to adversely affect the train operation, redundancy shall be provided in the system.

4.5.4 Redundant sub-system shall change over seamlessly when active system fails. If changeover has a finite time, contractor shall show that its system shall not obstruct the train operation.

4.5.5 The System shall be designed to generally recover from power supply disturbances without manual intervention. The failed axle counter track sections would require resetting as per Para 3.2.5 (2) (l) of this specification.

4.5.6 The Contractor shall minimize the risk of common mode faults in design of the subsystems providing redundancy.

4.5.7 The MTBF/MTBSAF of Interlocking, Track vacancy detection system, Power supply and other Signalling sub-systems shall be at least, as specified in the relevant RDSO specifications. Wherever failure of any sub-system/equipment is likely to adversely affect the train operation and Availability, redundancy shall be provided in the system.

4.6 AVAILABILITY

4.6.1 The Contractor shall be responsible for providing a system design, maintenance procedures, and defining the recommended spares holdings to ensure that the Availability requirements of the Signalling System are fully achieved.

4.6.2 The Contractor shall submit calculations with reliability block diagrams for each sub-system till LRU level to demonstrate the compliance with specified availability figures. The availability calculation shall take all possible failure modes (barring Non relevant failures, as per Para 4.4.3 above) into consideration that cause gap in service operation of system, subsystem, equipment or part thereof. The calculation shall be based on the Contractor's submitted equipment MTBSAF and MTTR data and the configuration of each sub-system.

4.6.3 Equipment duplication, hot-standby protection, parallel-run, path diversity, etc. shall be adopted whenever necessary and appropriate to meet the required availability.

4.6.4 Signalling System shall have Availability better than the targets specified here below:

System/Sub-System	Availability	Remarks
Electronic Interlocking System (including power supply, wiring, etc.)	99.98%	Availability per system
Track Vacancy Detection System (MSDAC/SSDAC, power supply, etc.)	99.99%	Availability per system
Train Management System	99.98%	Availability per system

4.6.5 Degraded performance or loss of any software or hardware dependent function of any end equipment shall be taken as unavailability.

4.7 PERTURBATION ANALYSIS

4.7.1 A detailed system perturbation analysis shall be performed stating the types of failures that could cause service interruptions and the failure management actions required to mitigate the effect of these failures.

4.7.2 The service interruption analysis shall document all failure modes capable of causing service interruptions.

4.7.3 The Contractor shall design the system to reduce the perturbations to the minimum. Operational actions, System design features or maintenance strategies that can reduce the impact of potential service interruptions shall be submitted to the Engineer for review.

4.8 MAINTAINABILITY

4.8.1 Maintainability requirements and goals shall be developed in terms of Mean Time to Restore (MTTR). The required MTTR shall be achieved for the whole System.

4.8.2 The system shall be designed such that the MTTR shall be less than one hour.

4.8.3 The MTTR shall include the diagnostic time, active repair / replacement time and adjustment / testing time, including software re-boot, up to the point the system is restored to full functionality. In the event that the failure cannot be rectified, the measurement shall include the time necessary to remove the failed piece of equipment from the System and replace it with a functional module.

4.8.4 The MTTR does not include the time taken for designated personnel to arrive on site (access time) to begin local diagnostic activities or the time taken for the replacement parts to be delivered at site.

4.8.5 The Contractor shall analyze each and every failure/defect of components of various equipment to determine the cause of failure and to propose preventive/corrective measures in the FMECA analysis.

4.8.6 The System shall be designed to minimize the need for frequent preventive maintenance.

4.8.7 Redundancy shall be used to enable any necessary preventative maintenance to be carried out on off-line systems during Traffic Hours.

4.8.8 Built-in self-diagnostics, power-up self-test and sufficient test points shall be provided in the System to minimize the time required to locate a fault.

4.8.9 As far as the technology permit, all vital plug-in modules shall permit hot swapping so as not to affect the normal or emergency operation of the system

4.8.10 The Contractor shall provide Service Life support as specified at Para 14.10 of the GS Vol 1 Part 2.

4.9 LOWEST REPLACEABLE UNIT (LRU)

4.9.1 All LRUs shall have weight that can be easily handled manually without posing any significant risk. The System shall allow the removal and reinstallation of LRUs without having to remove other LRUs, disconnect cables to other LRUs or disturb or power down other equipment.

4.9.2 Incorrect installation or incorrect attachment of any LRU to be prevented through mechanical design.

4.9.3 The System shall be designed to ensure that any components which are physically interchangeable but not functionally interchangeable cannot operate in the System.

4.9.4 LRU electrical connections shall be formed by using plugin units as far as practicable.

4.9.5 The System shall be designed such that Electronic racks are removable. The System shall be designed such that access panels can be removed without the use of special tools.

4.9.6 The System shall maximize the use of remote means to conduct maintenance, fault finding and fault rectification activities and to access maintenance information.

4.9.7 The Signalling System shall display all detected failures on the S&D terminal at the Station and in the OCC.

4.9.8 Fault indications should clearly indicate which LRU is affected and the degree of the failure and loss of functionality.

4.9.9 Where the System architecture is such that Signalling control systems are distributed across the section and where all maintenance testing and diagnostics cannot be conducted entirely remotely from the OCC, the local Control and Indication means shall be provided at these locations for maintenance purposes.

4.10 SAFETY ENGINEERING

Safety is defined as freedom from those conditions that can cause death, injury, occupational illness, or damage to or loss of equipment or property, or withdraw the train from service. All circumstances susceptible to cause injuries or death of a person (public, operation staff, maintenance staff), and by extension all events leading to a partial or total destruction of costly equipment are considered as a risk.

4.11 SYSTEM SAFETY PLAN

The Contractor shall develop System Safety Plan in accordance with EN 50126 and submit the same for review and approval of the Engineer.

4.11.1 Safety Principle

- (1) All equipment and sub-systems, including software, affecting safety and identified as being "vital", shall be designed according to the following principles:
 - (a) Only components having a high reliability and predictable failure mode shall be used.
 - (b) Components must be utilized in such a manner that ensures that a restrictive, rather than a permissive condition will result from hardware,

- software or any part of the equipment failure.
- (c) Circuits shall be designed such that when a normally energized electric circuit is interrupted or de-energized, it will cause the controlled function to assume its most restrictive condition.
 - (d) System safety equipment design shall be such that any single independent component or subsystem failure results in a restrictive condition. Failures that are not independent, those failures which, in turn, always cause others, must be considered in combination as a single failure and must not cause a permissive condition.
- (2) The Signalling system shall fully conform to the interlocking principles as specified in the Indian Railway Signal Engineering Manual
 - (3) During consideration of precedence in the control of system hazards, the Contractor shall take actions to satisfy requirements in the following order of precedence:
 - (a) Incorporation of fail-safe on vital features which would allow the system to transfer from a high loss or risk mode to a lower loss or risk mode upon the occurrence of a critical failure; and,
 - (b) Reduction of the probability of occurrence of a failure by increased component reliability or by provision of supervised redundant components.

4.11.2 Safety Requirements

- (1) The contractor shall be fully responsible for the system safety within his domain through the application of engineering and management principles, criteria and techniques to optimize all aspects of safety throughout all phases of the System life cycle.
- (2) The safety level of Electronic Interlocking (EI) and Track Vacancy Detection Systems realized with software shall satisfy the SIL4 safety level. The software design process of TMS shall conform to SIL 2 level.
- (3) Component failure shall be self-detecting by way of causing a signal to display a most restrictive aspect as far as practicable. Failure of components which are not self-detecting shall not cause any unsafe failure of the equipment.
- (4) The design of the equipment shall cater for detection and restoration of system to a safer state in case of following faults if these are likely to result in unsafe condition:
 - (a) Variation in power supply beyond its tolerance limits.
 - (b) Spikes in the power supply system.
 - (c) Insertion of PCBs in wrong card slots.
 - (d) Earthing of any component or wire or a combination of such earthing faults.
 - (e) Broken wires, damaged or dirty contacts, failure of a component to energize, loss of power supply or blown fuses etc.
- (5) During each stage in the design and development process, the Contractor shall take cognizance of any hazard that arise as a result of the design or operation of the proposed equipment and take immediate steps to change the design or operation principles of the proposed equipment to mitigate the hazard.

- (6) Occurrence of any failure or error of operation in the axle counter components must not lead to any hazard but should rather transit to a safe state.
- (7) The Contractor shall use safety devices to reduce the magnitude of the loss or risk once a hazardous mode has been entered; and ensure that the safety device does not introduce an additional hazard or system malfunction.
- (8) The Contractor shall use warning devices and systems which are audio/visual portion of a vital system in which the human is the responder. The Contractor shall recommend special equipment operating procedures to reduce the probability of a hazardous event.
- (9) A Hazard Log shall be established as a basis for on-going risk management. The hazard Log shall be updated with each event identified and mitigated. Residual Risk shall be carried forward and rules and procedures proposed to the Engineer for the Management of such Residual Risk.
- (10) During the Design Review process, the Contractor shall submit analysis for Engineer's review, which demonstrates compliance with these safety principles. These analyses shall address the following issues:
 - (a) Circuit design;
 - (b) Hardware design (Failure Modes, Effect and Criticality Analysis);
 - (c) Electrical interference;
 - (d) Software errors; and
 - (e) System failures.
- (11) All metallic enclosures shall be provided with an earth terminal.
- (12) The design of the System shall minimize the risk of fire.
- (13) The design of the System shall minimize the build-up of static, as well as the effects of static discharge during maintenance.
- (14) Components or materials containing toxic chemicals or asbestos should not be used unless absolutely necessary and where they are to be used, they should be submitted to the Engineer for agreement.
- (15) The safety level of each function outlined in this specification shall be defined and demonstrated by the Contractor in accordance with the process defined in General Specifications.

4.11.3 Risk Acceptance Criteria

- (1) Risk is defined as probable rate of occurrence of a hazard causing harm and the degree of severity of the harm. Risk acceptance shall be based on the principle of "As Low as Reasonably Practicable" (ALARP) based on the guidelines set out in EN 50126.
- (2) The frequency of occurrence of hazardous event is categorized into different rankings:

Category	Description
Frequent	Likely to occur frequently. The hazard will be continually experienced.
Probable	Will occur several times. The hazard can be expected to occur often.

Category	Description
Occasional	Likely to occur several times. The hazard can be expected to occur several times.
Remote	Like to occur sometime in the system life cycle. The hazard can be reasonably expected to occur.
Improbable	Unlikely to occur but possible. It can be assumed that the hazard may exceptionally occur.
Incredible	Extremely unlikely to occur. It can be assumed that the hazard may not occur.

(3) The hazard severity is categorized into different hazard consequence levels:

Hazard Category	Consequence	Description
4	Catastrophic	Operating conditions such that personnel error, environment, design deficiencies, subsystem or component failure or procedural deficiencies may cause death or system loss.
3	Critical	Operating conditions such that personnel error, environment, design deficiencies, subsystem or component failure or procedural deficiencies may cause severe injury to personnel, severe occupational illness or major system damage.
2	Marginal	Operating conditions such that personnel error, environment, design deficiencies, subsystem or component failure or procedural deficiencies may cause minor injury to personnel, minor occupational illness or minor system damage. Acceptable with adequate control and agreement of the Employer.
1	Negligible	Operating conditions such that personnel error, environment, design deficiencies, subsystem or component failure or procedural deficiencies will not result in injury to personnel, occupational illness or damage to the system.

(4) Risk classification of hazards:

Frequency		Consequence			
		Catastrophic (Category 4)	Critical (Category3)	Marginal (Category2)	Negligible (Category1)
Frequency	Frequent	I	I	I	II
	Probable	I	I	II	III
	Occasional	I	II	III	III
	Remote	II	III	III	IV
	Improbable	III	III	IV	IV
	Incredible	IV	IV	IV	IV

(5) The Risk Classes are defined as follows:

Risk Class		Interpretation
Class I	Intolerable	Intolerable risk. Shall be eliminated
Class II	Undesirable	Undesirable risk, and tolerable only if risk reduction is impracticable or if the costs are grossly disproportionate to the improvement gained. Shall only be accepted when risk reduction is impracticable and with the agreement of the Railway Authority or the Safety Regulatory Authority, as appropriate
Class III	Tolerable	Tolerable risk if the cost of risk reduction would exceed the improvement gained. Acceptable with adequate control and with the agreement of the Railway Authority.
Class IV	Negligible	Negligible Risk. Acceptable with/without the agreement of the Railway Authority

- (6) Risk acceptance shall be based on the principles of "As Low as Reasonably Practicable" (ALARP) and as follows:
- (a) Category 4 hazards shall be not greater than one unsafe incident in one hundred years (1:100 years).
 - (b) Category 3 hazards shall not be greater than one unsafe incident in one hundred years or only be accepted when the risk reduction is impractical and with the agreement of the Employer.
 - (c) Category 2 hazards shall only be permitted if a desired benefit is demonstrated as generally acceptable within accepted levels for the international railway industry and in agreement with the Employer.
 - (d) Category 1 hazards shall only be permitted if assured that the risk will remain at that level and any residual risk shall be mitigated by Operating Rules and Procedures.

4.11.4 Hazard Analysis

- (1) The Contractor shall, as part of the safety analysis, prepare analysis to identify Hazards and ensure their satisfactory resolution. The following analysis shall be prepared and submitted by the Contractor for the Engineer's acceptance:
 - (a) Preliminary Hazard Analysis (PHA)
 - (b) Subsystem Hazard Analysis (SSHA)
 - (c) Interface Hazard Analysis (IHA)
 - (d) Operating and Support Hazard Analysis (O&SHA)
 - (e) Quantitative Fault Tree Analysis (QFTA)
 - (f) Failure Modes, Effects and Criticality Analysis (FMECA)
- (2) The Contractor shall carryout the Hazard Analysis and FMECA/FTA for key equipment / sub-systems / systems. As a result of hazard analysis, the Contractor shall:
 - (a) Identify and list the hazards

- (b) Identify and list the Safety Requirement Specifications
 - (c) Identify and list the safety related functions
 - (d) Specify for each safety related function the safety related failures
 - (e) Identify and list the safety critical and non-safety critical items.
- (3) The Hazard Review Procedure shall be submitted for the Engineer's approval. The final risk assessment, acceptance of mitigation and close out of hazards shall conform to the approved safety and risk acceptance criteria.
 - (4) The following targets/norms shall be employed for the Fault Tree Analysis. These norms are subject to review by the Engineer during the detailed design stage, and mutually agreed upon:
 - (a) No single point failure shall lead to fatality.
 - (b) No combination of undetected failure and double point failures shall result in fatality.
 - (c) No combination of undetected failure and single point failure shall result in major injury.
 - (5) The Hazard Log shall be substantially complete prior to commencement of Trial Running and shall be handed over to the Employer complete in all respects prior to the commencement of Revenue Service.
 - (6) The Contractor shall fully develop a Safety Critical Items List (SCIL) which shall be updated as required and carried forward throughout implementation until final resolution of identified hazards is achieved.
 - (7) Further, the information presented by the Contractor shall be supported by the history of tests conducted and by approved test certificates from accredited laboratories which attest to the engineering program characteristics and behaviour.
 - (8) The procedures for Operation, Maintenance, Training and the Contractor Quality Assurance manuals shall incorporate resolution of hazards so identified from this Hazard Analysis. Proper cross-referencing to the hazards and resolution measures shall be provided in all these aforementioned documents.

4.11.5 Design/Systems Safety Studies and Report

- (1) The Hazard analysis process shall identify the need for Design Safety Studies and the Hazard Log shall record the results of each of these Design Safety Studies.
- (2) Design Safety Studies shall be undertaken for system and subsystem elements that are considered to be safety critical and that require hazard analysis to a greater level of detail than that applied at an overall system wide level.
- (3) Design Safety Studies shall specifically refer to hazards arising from:
 - (a) normal operations including maintenance;
 - (b) degraded modes of operation;
 - (c) emergency situations; and
 - (d) the effectiveness of mitigation proposed for natural catastrophes.
- (4) The Design Safety Studies shall take account of:
 - (a) methods of operation;

- (b) RAM considerations;
 - (c) anticipated likely maintenance regimes and their sustainability in Commercial Operation;
 - (d) anticipated competence levels of personnel in Commercial Operation;
 - (e) software security (disabling of unauthorized access to operating systems, protection against intrusive attacks, loss of password integrity, etc.); and
 - (f) Other human factors including but not limited to those identified in ergonomic studies.
- (5) Design/Systems Safety Studies and the Report shall demonstrate, as a minimum, the following requirements:-
- (a) That the overall risk criteria for the Works have been addressed satisfactorily at the Detailed Design stage and that the Detailed Design proposals are mutually compatible with such risk criteria.
 - (b) That all Safety Critical systems have been identified at the Detailed Design stage and the apportionment of risk factors between the major systems and sub-systems support the overall safety criteria approved in the "System Safety Plan".
 - (c) That the results of the Design Safety Studies have been incorporated into the design, and shall be carried forward into the Final Design, manufacturing and installation processes.
 - (d) That where management by operating and/or maintenance procedure or other management control measures have been identified during the "Design Safety Studies", auditable methods by which such measures shall be introduced into operating/maintenance provisions have been established.
 - (e) That robust processes have been implemented to validate the Safety Critical aspects of software design.
 - (f) That processes for assessing the potential safety impact of design changes exist.
- (6) The Design/Systems Safety Studies and a Report shall be submitted at the completion of the Detailed Design period to confirm that all safety related aspects of design have been properly addressed and comprehensively validated.

4.11.6 Engineering Safety Validation Plan and Report

- (1) The contractor shall submit Engineering Safety Validation Plan that will outline the safety related tests to be conducted during the on-site testing and integrated system testing phase. The document will include the validation of the safety requirements for the system such as output voltage of DC-DC converter or an inverter shall not exceed pre-set value. Throughout this document details test cases carried out in order to validate the system, the relationship of the effects found in these tests and the validation of the same in subsequent tests will ensure that the system comply with the safety requirements.
- (2) An Engineering Safety Validation Report will be submitted after the completion of this testing.

4.11.7 Safety Case

The contractor shall submit the Safety Case which will be a documented demonstration that the product complies with the specified safety requirements. The Contractor may be required to issue updated Safety Case conforming to EN50129 after Trial Run. The Safety Case forms part of the overall documentary evidence to be submitted to the relevant safety authority in order to obtain safety approval for the system.

4.11.8 Independent Safety Assessor

- (1) The Employer may appoint an Independent Safety Assessor (ISA) for Independent third party assessment of safety of the Signalling system and Safety assessment of non RDSO approved Generic Product - Electronic Interlocking and Digital Axle counter, if imported in accordance with Para 5.2.4 of this specification. .
- (2) The ISA will carry out Independent Safety Assessments and Independent Safety Audits covering all Safety critical (SIL 3 and 4) and Safety related (SIL 1 & 2) systems as required and functions for the Signalling System. The ISA Safety activities will closely follow every stage of the Project development process i.e. detailed Hardware and Software design, V&V, Installation and Testing stages, Trial runs etc.
- (3) The ISA will carry out the Safety Assessment based on review of the Contractors' documentation pertaining to quality/safety aspects throughout the various stages of development of the Signalling System and Inspections and Safety Audits within the Contractor's entities and on site.
- (4) The Safety assessment of the Generic Product – Electronic Interlocking and Digital Axle Counter will be carried out by the ISA as per DFCCIL 'Cross acceptance/approval policy' at Appendix 2.
- (5) The Contractor shall ensure that ISA is provided with full assistance in performance of his duties. The Contractor shall provide ISA with all the documents, as requisitioned by him from time to time. The Contractor shall facilitate all arrangements for ISA's Safety audits within the Contractor's entities and on site. The Safety assessment of the Generic Product(s) would also require Tests and Trials, for which the Contractor must make all the arrangements.
- (6) The ISA will prepare a report after each audit/assessment and share it with the Contactor for comments. The ISA will finalize the report giving due consideration to the Contractor's comments.
- (7) The ISA's findings shall be recorded through Observations. For each Observation identified during an Independent Safety Assessment or Audit, a classification will be assigned to facilitate management action. These shall be as follows:

Category I	Issue is sufficiently important to require immediate resolution prior to recommending any related deliverable to be moved to next stage of development lifecycle.
Category II	Issue is sufficiently important to require resolution within 3-6 months, but the related deliverable can be moved to next stage of development lifecycle (possibly with a protective control measure).
Category III	Issue is highlighted for minor error or as recommendation for improvement. Follow up action is not a must.

- (8) The ISA will prepare and maintain a log of ISA observations. This log will describe each observation, the category and status of each observation, the Contractor's responses to each observation and ISA's evaluation of these responses and in the event of closure of an observation, the reasons for closure.
- (9) The ISA log will be regularly shared with the Contractor. The Contractor shall address the issues flagged by the ISA within the prescribed time frame.
- (10) It is the Contractor's responsibility to ensure that the ISA in his Final Assessment report confirms that the Signalling system provided by the Contractor adheres to applicable SIL 4 level process from Design to Testing and commissioning stages, including application data of Vital equipment for the Signalling system; and that the Safety risks for each safety related and safety critical sub-system are correctly identified and reduced to an acceptable level; and the Signalling System is capable of being operated and maintained to an adequate level of safety.
- (11) Except for ISA Experts' remuneration, allowances, travel and stay, rest all the costs associated with ISA's Safety assessment such as providing documentation, making arrangements for ISA Safety audits and inspections, cost of corrective actions for ISA observations, Tests and Trials etc. shall be borne by the Contractor.

4.11.9 Relational Database Management System

- (1) All hazard resolution by procedural control shall be cross-referenced from the safety critical and non-safety critical Items List to the appropriate manuals. The results of the Hazard Analysis shall be recorded and maintained by the Contractor in a Hazard Log in the form of a relational database that can be used to track progress in the implementation of mitigating actions and control measures, and provide an easily accessible reference for the future Operator of all actions taken with respect to any hazard of any type in an any location for any area of activity. Proper cross-referencing to the hazards and resolution measures shall be provided in all these afore mentioned documents.
- (2) The fully functional soft copy of the relational database management system shall include together with all passwords, supporting software and instructions on its use and further development during Revenue Service.

4.12 RAM DEMONSTRATION

4.12.1 RAM Demonstration Plan

- (1) The Contractor shall submit RAM Demonstration Plan to the Engineer for approval before the final design review to demonstrate that all RAM predictions and specifications are met.
- (2) The requirements relating to Maintainability shall be demonstrated before the commencement of Trial Running and may begin as soon as the necessary systems or elements of systems have been tested and commissioned.
- (3) The requirements relating to Reliability and Availability shall be demonstrated throughout Trial Running Period and the Defects Liability Period.

4.12.2 Failure Reporting and Corrective Action System (FRACAS)

- (1) The Contractor shall be required to establish a computer based Failure Reporting and Corrective Action System (FRACAS) during the RAM Demonstration phase.

The FRACAS proposed by the contractor shall need the approval of the Engineer.

- (2) The FRACAS shall:
 - (a) Provide a process for reporting, classifying, analysing failures, and planning corrective actions in response to those failures.
 - (b) Collect data, record and analyse system failures.
 - (c) Produce a history of failure and corrective actions.

4.12.3 Reliability Demonstration

- (1) During the RAM demonstration phase, the Contractor shall collect and maintain data on every failure of the system provided by him along with the data indicating the probable failure. MTBSAF shall be calculated throughout the monitoring period. The Contractor shall submit monthly Reliability Demonstration Reports.
- (2) In case the Contractor is not able to achieve specified/predicted reliability target, the Contractor shall take necessary corrective measures either by way of change of design and/or replacement of the relevant equipment / component, at no additional cost to the Employer.
- (3) The Contractor shall analyze each and every failure/ defect of components of various equipment to determine the cause of failure and propose corrective measures, which would be reviewed by the Engineer.

4.12.4 Maintainability Demonstration

- (1) The Contractor shall carry out tests on all the system provided by him to demonstrate that all maintainability predictions provided are met.
- (2) The maintainability demonstration shall consist of simulated failures and repair activities, the duration of which shall be measured to determine the MTTR. As an alternative, data from actual maintenance actions for relevant independent failures occurring during the testing period may be used in lieu of simulation.
- (3) A minimum of 50 maintenance actions shall be included for this demonstration.
- (4) The maintenance actions shall be distributed among the equipment of each test group in proportion to their expected failure occurrence and in accordance with the MTBSAF.
- (5) In the event that any maintainability target is not achieved, the Contractor shall at his own expense take whatever action is deemed necessary to meet the maintainability targets.
- (6) The Contractor shall ensure that all the required information including the related Maintenance Work Instructions (MWI) etc. are available to enable him to demonstrate the maintainability targets.

4.12.5 Availability Demonstration

- (1) The Contractor shall demonstrate the specified Availability during Service Trials and during the DLP. The Availability Demonstration Testing (ADT) shall be conducted on all Systems, subsystems and their interfaces.
- (2) The demonstration test measure for Availability shall consider the performance of the Contractor's installed equipment, and the effectiveness of maintenance procedures recommended by the Contractor.

- (3) The availability shall be worked out on the basis of the formula given during the preceding six months. In the event that the availability target as specified is not achieved, the Contractor shall,
 - (a) The determination of availability achievement in the preceding six month period shall be continued at monthly intervals until the target is achieved.
 - (b) The contractor at his own expense will take action deemed necessary to meet the availability requirement.

4.13 ENVIRONMENT

4.13.1 Details of climatic conditions generally prevalent in Khurja-Dadri section are given in Para 2.17 of GS Vol.1 Part 2 Section VI.

4.13.2 The Signal Equipment rooms and Power Supply Equipment rooms in the OCC and at the Stations as part of Station Building, are being built by Other contractor(s). These rooms have the following Environment classifications:

- (1) Signalling Equipment Room(s) in OCC: Class A.
- (2) Signalling Equipment Room(s) at Station: Class B1.
- (3) Power Supply Equipment Room (s) in OCC and at Stations: Class B2.

4.13.3 The Signalling Equipment Rooms and Signalling Power Supply Equipment Rooms at Auto Location Huts in the Block section and at the Relay Huts in Station/Block section, to be built by the Contractor shall normally have Class B2 type Environment classifications.

The Contractor shall provide in the above rooms, RDSO type ventilation system with redundancy (1+1) to regulate temperature and maintain air circulation within limits. The Contractor may, however provide Air-conditioning of these rooms/equipment racks, wherever necessary for environment control or for improvement of reliability of specific Signalling equipment or its power supply.

4.14 EMC/EMI REQUIREMENTS

4.14.1 The Signalling system provided should be electromagnetically compatible with other systems viz. Electrification, Telecommunication and Rolling Stock as per relevant national and international standards specified at Para 5.1.2 of this specification.

4.14.2 The Contractor shall conduct the EMI Hazard analysis at the preliminary design stage to identify sources of EMI likely to affect the Signalling system, its consequences and EMC protective measures, all of which should be detailed in the EMI Hazard analysis report. The EMI Hazard analysis report shall be submitted to the Engineer for review and acceptance.

4.14.3 EMC Control Plan

- (1) The contractor shall prepare an EMC control plan and submit it to Engineer for review and acceptance.
- (2) The plan shall analyse EMI/EMC impacts on the design of the Signalling System including trackside equipment as well as the general environment.
- (3) The Plan shall specify measures to increase immunity of the Signalling system.
- (4) The Plan shall include measures to reduce conducted, induced and radiated emissions to acceptable levels as specified by the relevant national and

international standards.

- (5) The plan shall specify basic protective measures proposed for all electrical and electronic subsystems and components and specific measures to be adopted for the selected subsystems and components.

4.14.4 Intra system EMI

The Contractor shall ensure that any intra system EMI is mitigated through proper design and other special measures. All major subsystems shall be tested for emissions and immunities in accordance with the appropriate international standards for equipment operating in Railway or similar industrial environment as listed under para 5.1.2.

4.14.5 Inter system EMI

- (1) The Contractor shall ensure that the Signalling System is designed and manufactured in accordance with the latest issues or versions of internationally recognized EMC standards, including but not limited to EN50081, EN50082, EN50121, EN50123, IEC571, EN50155, and IEC61000 to ensure proper functioning.
- (2) The contractor shall identify all likely sources of EMI that are prevalent in the environment. Adequate measures may be taken to ensure correct operation of the Signalling system in its intended operating environment.

4.14.6 EMC Tests

- (1) The contractor shall not be required to conduct EMC tests if it can be demonstrated that the same have been done at the design stage of his equipment. However, if EMC tests were not done or if no test reports are submitted, the tests have to be conducted in accordance with, but not limited to satisfying following standards for overall compliance:
 - (a) EN50121-1
 - (b) EN50121-2
 - (c) EN50121-4
 - (d) EN50121-5
- (2) In all cases where tests are not conducted, waiver for the same may be applied along with justification for approval of the Engineer.
- (3) For any standard off-the-shelf products, their EMC test certificates shall be submitted to the Engineer for review.

4.14.7 Safety related Systems Interference (Hardware/Software interfaces & protocols)

- (1) Special attention shall be given to the interference with safety related operations and equipment such as communication systems. Adequate safety margins must be ensured between the immunity levels of these safety related systems and emission levels of the Signalling and Control System specified by prevailing international standards.
- (2) If considered necessary, following measures shall be taken to improve the immunity of the signalling system. These measures shall include, but not limited to the following actions:
 - (a) Proper grounding to reduce ground-loop coupling.
 - (b) Proper cable shielding to reduce common-mode coupling.

- (c) Proper use of twisted-pair cable to reduce differential mode coupling.
- (d) Proper magnetic shield to reduce low-frequency magnetic field interference from the traction system.
- (e) Use steel cable supports (trunkings, trays, etc.) instead of aluminium.
- (f) All cable supports shall be grounded.
- (g) Correct choice of operating frequency.
- (h) Use of filter to reject out-of-band noise.
- (i) Proper use of surge arrestor.
- (j) Use of high-level modulation technique to improve the immunity of the system.
- (k) Use of redundancy codes/check sum etc. to improve the immunity of the system.
- (l) Use of parallel-check technique to improve the immunity of the signalling system.
- (m) The probabilities of various conditions which could lead to an unsafe operation shall be determined and action to resolve the same shall be taken.
- (n) An appropriate technical construction file suitable for safety audit shall be submitted or if not available developed to demonstrate EMC compliance.

4.14.8 Installation mitigation guidelines for Cabling

- (1) The cables used in the signalling system shall be adequately protected against external interference.
- (2) Additional protective measures, including but not limited to the use of metallic conduit, armour, ferrite choke and EMI filters shall be used to reduce such external interference wherever required. Covered conduit is preferred.
- (3) The cables shall also be installed at a safe separation from potential interfering sources, including power cables etc.
- (4) A cable routing plan shall be designed so that there is least likelihood of coupling between the signalling cables and the extraneous potential sources. For example, long parallel run of signalling cable and power cable shall be avoided unless they are enclosed within separate conduits/covered troughs.
- (5) The Contractor should refer to guidelines recommended by IEC61000-5-2, wherever possible for signal trunking /conduit separation.
- (6) For protection against electrostatic capacitance coupling, direct electrical connection between ducts of power cables and signal cables shall be avoided.

4.14.9 The latest versions of IEC61000-5 and other relevant standards shall be complied with wherever applicable.

(End of Chapter 4)

CHAPTER 5: GENERAL REQUIREMENTS

5.1 PROJECT DESIGN STANDARDS

5.1.1 High Level Standards

- (1) The project requires contractors to work within the framework of the international standard for Quality Management ISO 9000.
- (2) Working within IEC61508, Functional Safety of Electrical/Electronic/Programmable Electronic Safety-related System, the suppliers/contractor should demonstrate how compliance will be achieved for this project.
- (3) Where systems and products have been designed and are approved against Design standards as specified at Para 5.1.2 below, full details of approval shall be given. Where systems and products have been approved within other markets, for example against US FRA standards, then a gap analysis between the design and approving standard and the appropriate design standard specified at Para 5.1.2 below shall be required before products are approved for use on the project. The contractor will be required to give detail of how the gap analysis will be conducted.

5.1.2 Design Standards

- (1) The generic standards or other equivalent standards which are specified as under shall be applied for Signalling system.
 - (a) RDSO: Research, Design and Standards Organization, Ministry of Railways, India.
 - (b) IEC: International Electro-technical Commission.
 - (c) EN: European Standards Organizations CEN, CENELEC or ETSI.
 - (d) ISO: International Standards Organization
- (2) Research Design and Standards Organization (RDSO), an organization of the Ministry of Railways, Government of India has standardized the technical specifications for various components of railway systems in India as Indian Railway Standard (IRS) Specifications. These are generally based on International Specifications and adopted to Indian conditions. The list of IRS/RDSO Specifications issued by RDSO is available at the website of RDSO (www.rdsogov.in). The IRS/RDSO specifications can be purchased from RDSO.
- (3) For the Signalling system, the following specified standards (with latest amendments) shall be followed:

SPECIFICATION NO.	DESCRIPTION
IRS SPECIFICATIONS	
S 6-81	Tubular Steel Signal Poles
S 21/01	Electric Key Transmitter
S 23 - 88	Electrical and Electronic based signalling and interlocking equipment. Part 1: Technology & General requirements. Part 2: General requirements for Electrical signalling & inter-locking equipment.
S 24 - 2002	Non-trailable electric point machine
S 26 - 64	Colour light signal, multi-unit type
S 34 - 68	Testing Railway Signalling relays (General)

SPECIFICATION NO.	DESCRIPTION
S 36 - 87	Route Relay interlocking systems
S 42 - 85	Axle counting equipment
S 43 - 73	Automatic signalling for unidirectional traffic
S 63 - 2014	PVC insulated armoured unscreened underground cables for Railway signalling
S 63 – 2014 IS: 1554 (Part 1)	PVC insulated armoured unscreened underground power cables
S 66 - 84	Route indicator, direction type 5 lamp unit arm (1 to 6 way)
S 75/2006	ARA terminal blocks and fuse blocks-made of PBT/Polycarbonate
S 76 -89	PVC insulated indoor cables for Railway signalling
S 77/2006	Tag blocks for Signalling Installations
S 78/92	Non deteriorating type of low voltage electric fuses for Railway Signalling
S 93 – 96(A)	Valve Regulated (Sealed) Lead Acid Stationary Battery & Charger for Railway S&T Installations
S 101 - 90	Railway Signalling symbols
S 105/2012	Block Proving by Axle Counter using UFSBI
TC-30/2005	Four / Six Quad Underground Jelly Filled Cables
TC-55-2006	24 Fibre Armoured Optic Fibre Cable
RDSO SPECIFICATIONS	
RDSO/SPN/144/2006	Safety & Reliability requirement of Electronic Signalling Equipment
RDSO/SPN/153/2011	LED Signal lighting unit
RDSO/SPN/165/2012	SMPS based Integrated Power supply system (IPS)
RDSO/SPN/175/2005	Solid State Block Proving by Axle Counter (Digital) for Double Line & Single Line
RDSO/SPN/176/2013	Multi Section Digital Axle Counter
RDSO/SPN/177/2012	Single Section Digital Axle Counter
RDSO/SPN/189/2004	Modular Terminal Blocks, Fuse terminal blocks and Miniature fuse links of international standard for Railway Signalling
RDSO/SPN/192/2005	Electronic interlocking
RDSO/SPN/197/2008	Code Practice for Earthing and Bonding system for Signalling equipment
RDSO/SPN/203/2011	Electronic Interlocking for Big Yards
RDSO/SPN/204/2011	Double Walled Corrugated HDPE ducts for signalling cables
RDSO/SPN/208/2012	Electric Lifting Barrier
RDSO/SPN/256/2002	Earth Leakage Detector
STS/E/Relays/AC Lit LED Signal/09-2002	Universal Plug-in type, tractive armature AC Lamp proving relay (metal to carbon) for 110V AC LED Signal Lamp
EUROPEAN STANDARDS	
EN 50121 1,2,3,4	Railway applications - Electromagnetic compatibility
EN 50124 - 1	Railway applications - Insulation coordination - Part 1: Basic requirements - Clearances and creepage distances for all electronic equipment

SPECIFICATION NO.	DESCRIPTION
EN 50124 - 2	Railway applications - Insulation coordination - Part 2: Over-voltages and related protection
EN 50125 - 3	Railway applications - Environmental conditions for equipment - Part 3: Equipment for signalling and communications
EN 50126	Railway applications - The specification and demonstration of Reliability, Availability, Maintainability and Safety (RAMS)
EN 50128	Railway applications - Communication, signalling and processing systems - Software for railway control and protection systems
EN 50129	Railway applications - Communication, signalling and processing systems - Safety related electronic systems for Signalling
EN 50159 - 1	Railway applications - Communication, signalling and processing systems - Part 1: Safety related Communication in closed transmission systems
EN 50159 - 2	Railway applications - Communication, signalling and processing systems - Part 1: Safety related Communication in open transmission systems.
EN 60529	Specification for degrees of protection provided by enclosures (IP Code)
EN 50081 - 2	Electromagnetic compatibility - Generic Emission Standards - Part 2: Industrial Environment
EN 50123	Railway Application-Fixed installations .D.C. Switchgear. General
EN 50082 - 2	Electromagnetic compatibility. Generic immunity standard. Industrial environment.
EN 60364	Lightning and Surge protection
EN 61643	Lightning and Surge protection
EN 62305	Lightning and Surge protection
EN 60204 - 1	Safety of machinery. Electrical equipment of machines. General requirements
IEC 61000.4.2	Electromagnetic compatibility (EMC) - Testing and measurement techniques - Electrostatic discharge immunity test and basic EMC
IEC 61000.4.4	Electromagnetic compatibility (EMC) - Testing and measurement techniques - Electrostatic fast transient/burst immunity test and basic EMC publication
IEC 61000.4.5	Electromagnetic compatibility (EMC) - Testing and measurement techniques - Surge and immunity test
IEC 62278	Railway Applications- Specifications and demonstration of Reliability, Availability, Maintainability & Safety.
IEC 62279	Railway Applications-Communications, Signalling and processing systems-software for Railway Control and Protection Systems.
IEC 62425	Railway Applications-Communications, Signalling and processing systems- Safety Related Electronics Systems for Signalling.

SPECIFICATION NO.	DESCRIPTION
IEC 62427	Railway Applications- Compatibility between Rolling Stock and Train Detection Systems
IEC 62280-1	Railway Applications-Communications, Signalling and processing systems – Safety related communication in closed transmission systems.
IEC 62280-2	Railway Applications-Communications, Signalling and processing systems - Safety related communication in open transmission systems.
IEC 62236	Railway Applications – Electromagnetic compatibility (EMC)
IEC 60571	Electronic Equipment Used on Rail Vehicles
IEC 61373	Railway Applications – Rolling stock equipment – Shock and vibration tests
IEC 62305	Protection against Lightning
IEC 61992	Railway applications – Surge arresters and low-voltage limiters for specific use in. D.C. systems
IEC 60364	Electrical Installations for Buildings
IEC 62505	Railway applications – Fixed installations – Particular requirements for A.C. switchgear
ISO/TR 16982:2002	Ergonomics of human-system interaction -- Usability methods supporting human-centred design
ISO 11064 Parts 1-7	Ergonomics Design of Control Centres

5.1.3 Following manuals and schedules shall also be referenced during the design:

- (1) Indian Railways Signal Engineering Manual (IRSEM).
- (2) General Rules (GR) of DFCCIL/IR.
- (3) AC Traction Manual (ACTM) of IR.
- (4) Indian Railways Permanent Way Manual (IRPWM).
- (5) Schedule of Dimensions (SOD) of Eastern Corridor of DFCCIL.

5.1.4 Following Indicative Typical arrangement drawings shall also be referenced during the design:

- (1) Single line diagram for 1-phase input & 1-phase output UPS system (Annexure I of Appendix 1)
- (2) Single line diagram for 3-phase input & 3-phase output UPS system (Annexure II of Appendix 1)
- (3) DFCC Cable Laying in Station Yard (Annexure II (a) of Appendix 3)
- (4) DFCC Cable Laying in Block section (Annexure II (b) of Appendix 3)
- (5) Cable trench (Annexure III of Appendix 3)
- (6) Laying of cables in rocky area (Annexure IV of Appendix 3)
- (7) Track crossing (Annexure V of Appendix 3)
- (8) Road crossing (Annexure VI of Appendix 3)
- (9) Cable laying on culverts with low flood level (Annexure VII of Appendix 3)
- (10) Cable laying on culverts with high flood level (Annexure VIII of Appendix 3)

- (11) Cable laying on metallic bridges (Annexure IX of Appendix 3)
- (12) Cable Trough for metallic bridges (Annexure X of Appendix 3)
- (13) Typical Scheme of Track vacancy detection system using MSDAC in Automatic Block section.(Appendix 4)
- (14) Typical Earthing and Bonding arrangement for Indoor Signalling equipment. (Annexure I of Appendix 5).
- (15) Typical Earthing, Bonding and Surge Protection arrangement for Location box having Electronic equipment. (Annexure II of Appendix 5).
- (16) Signalling System Architecture (Appendix 6)

5.2 PROCUREMENT

- 5.2.1 The contractor can procure items/equipment either locally (from India) or from the international market.
- 5.2.2 RDSO maintains an approved list of suppliers/vendors for various equipment/items/components to be used on railway systems in India. The list of suppliers/vendors approved for various items are available at the website of RDSO (www.rdso.gov.in). The list of applicable RDSO specifications is given in Para 5.1.2 of this Specification.
- 5.2.3 Equipment appearing in this list of applicable RDSO specifications at Para 5.1.2 and having RDSO approved vendor, if procured locally shall be from RDSO's "Approved list of firms for manufacture and supply" and as per relevant specification.
- 5.2.4 If any equipment appearing in this list of applicable RDSO specifications at Para 5.1.2 is imported, then the firm supplying the equipment shall be got approved from RDSO for manufacture and supply of the said equipment as per latest "Procedure Order for Cross Acceptance/Approval of Software Embedded Electronics Systems and New/Imported Technology Products for Railway Signalling" dated 08.07.2015, available at Signal Directorate, RDSO's website www.rdso.indianrailways.gov.in. However, in respect of Generic Products - Electronic Interlocking and Digital Axle Counters, the said Cross acceptance/ approval can also be obtained as per "Procedure Order for Cross Acceptance/Approval of Software Embedded Electronics Systems and New/Imported Technology Products for DFCCIL" placed at Appendix 2. But this Cross Approval of the Generic Product(s) will be entirely at Contractors' risk. The final approval to designs involving the Product and approval for manufacture/supply of the Product shall be given only after successful acceptance of Safety case assessment and Type tests, if any by RDSO/DFCCIL. In case of delay in acceptance of Safety case assessment and Type tests, if any beyond one year of award of contract, the Employer may at its discretion direct the Contractor to procure the Product from one of the RDSO approved vendors.
- 5.2.5 If any equipment/item other than covered at Para 5.2.3 and 5.2.4 above is proposed to be procured, then the same must be proven being in regular use as per 'Provenness criteria' laid down in Para 5 of "Procedure Order for Cross Acceptance/Approval of Software Embedded Electronics Systems and New/Imported Technology Products for DFCCIL", placed at Appendix 2. Such items/equipment shall be based on well-known National/International Standards. Details of the same should be submitted well in advance for review without objection by the Engineer.

(End of Chapter 5)

CHAPTER 6: CONSTRUCTION REQUIREMENTS

6.1 GENERAL

- 6.1.1 The construction requirements establish the overall procedures for the Contractor to follow for the Works that is related to the components manufactured off-site and supplied for installation, assembling and wiring of the Permanent Works. These requirements relate to their Manufacturing and installation in the system and associated activities.
- 6.1.2 The requirement of Construction/Installation Plan, Method Statement, Manufacturing/Procurement, Delivery, Storage and Installation at site are covered in detail in GS Vol. 1 Part 2. The requirement given here are specific requirements to be read in conjunction with the general requirements given in the GS.
- 6.1.3 The Contractor shall be required to demonstrate that the construction/installation system/procedure he has adopted would enable installation of equipment in the minimum time available commensurate with the project aims. The contractor shall identify and undertake the construction activities that are possible to be carried out away from the site and include them in his Construction/Installation Plan and Programme.

6.2 INSTALLATION

All the important Signalling equipment viz. EI, MSDAC, LED signals, IPS/UPS, Data loggers, point machines etc. shall be installed in accordance with RDSO/OEM's installation checklist. A certificate shall also be required to be issued by the OEM that the installation has been done in accordance with the Installation checklist and earthing and surge protection arrangements are adequate for satisfactory performance of the equipment. The equipment shall not be commissioned unless such a certificate has been issued by the OEM.

6.2.1 Indoor Installation

- (1) All items of Signalling system comprising active electrical and electronic components shall, as far as possible be located in the Signalling equipment rooms.
- (2) All wall-mounted equipment shall be installed at appropriate height to avoid any hazards to the person passing by. The Contractor shall ensure the fixture is of sufficient strength to hold the wall-mounted equipment in a secure and safe manner. Sufficient space shall be provided to allow for front maintenance access of the wall mounted equipment.
- (3) All floor mounted equipment cabinets in the equipment room shall be securely bolted to ground, properly aligned and levelled. Racks/cabinets shall be suitably protected against entry of rodents, lizards etc. and also from effects of vibrations generated from train movements. All cable entries shall be sealed using suitable cable sealing system. The floor mounted equipment cabinets shall be arranged in a way to allow sufficient space at the front and rear side of the cabinets for maintenance access.
- (4) The Equipment layout within the equipment room shall be designed to:
 - (a) Allow sufficient clearance for escape out of the equipment rooms in case of emergency.
 - (b) Allow sufficient space at the front and at the back of the equipment for the maintainer to attend to the equipment freely without obstruction.

- (c) Allow required space around the equipment as mandated by the OEM/RDSO specification.
- (d) Allow required space for future expansion of signalling system.
- (5) The Contractor shall submit the following to the Engineer for review at least three months before the commencement of the installation inside the equipment room:
 - (a) Drawings showing the equipment layouts and positions of the racks, cabinets and enclosures.
 - (b) Racks, cabinets, layout drawings showing the arrangement of individual module.
 - (c) Specifications, sample of all the mounting brackets and accessories.
 - (d) Equipment mounting and installation methods.
 - (e) Schematic diagrams and wiring diagrams of the System.
 - (f) Electrical distribution schematics within the room including the earthing details and
 - (g) Cable route diagrams for cables within the room.
- (6) Installation work inside the room shall be carried only after these submissions have been reviewed without objection by the Engineer.

6.2.2 Signalling Structures

- (1) For housing the Signalling Indoor equipment, at least the following structures shall be provided at each location.
 - (a) One Signal equipment room (SER) for housing Signalling equipment.
 - (b) One Power Supply Equipment room for housing Signalling Power supply equipment including batteries.
- (2) The size/layout of SER will depend on the number of Indoor equipment units, their size and installation as per contractor's design and equipment layout approved by the Engineer. The size of the SER shall be determined keeping provision of a 19" rack for future provision for TPWS and further space for a 19" rack for any future expansion/modification requirement.
- (3) The Station Buildings consisting of Signal Equipment rooms and Power supply equipment rooms for housing Signalling Equipment are being built under CP 302 as part of Station building. The Contractor shall coordinate with the contractor of CP 302 for construction of the same. The Station Building Plans are given in Part 4 - Reference documents. The air-conditioning of SER at Stations shall be provided by the contractor under Particular Specifications - 2x25 kV AC Traction Electrification and Associated Works, Vol. 2, Part 2. The additional building (Relay Hut) as required for housing Signalling Equipment at the Station/Block section and at IR Dadri ICD yard-Dadri area shall be built by the Contractor. The air-conditioning of this additional building, as required shall also be done by the contractor.
- (4) The building of Signal Equipment rooms and Power supply equipment rooms in the block section is within the scope of present contract and their number and location will be determined by Signalling design. These Signalling structures shall be located, to the extent possible, in busy habitats approachable by road, preferably near the Railway Level Crossings and adjacent to the

Telecommunication structures. The Signalling power supply equipment rooms can be combined with the Telecommunication power supply rooms where they are co-located. The contractor shall provide the ventilation and air-conditioning of these rooms in accordance with relevant provisions of this specification.

- (5) Opening/closure of Signal Equipment rooms at the station and in the block sections shall be indicated on the SM's Control Terminal and Signal maintainer's S&D workstation at the Station, and at the OCC.
- (6) Arrangement for remote monitoring of the air-conditioning system, temperature-regulator equipment and air-circulation equipment of Signal Equipment Rooms, Telecom Equipment Rooms and Signalling and Telecom Power supply Equipment rooms from OCC shall be provided, as part of S&D system.
- (7) Portable Fire Extinguishers shall be provided in all the Signal equipment rooms and Power supply equipment rooms at the Auto Location Huts in the block section and Relay Huts in the Station/Block section. Portable fire extinguishers shall be compliant to NFPA 10 standard and suited for electrical equipment fires.
- (8) Smoke and Fire detection system will be provided in all Signalling Equipment rooms and Signalling Power supply equipment rooms with facility of alarm generation at station and OCC, under Particular Specifications – 2x25 kV AC Traction Electrification and Associated Works, Vol. 2, Part 2. The Contractor shall do the necessary coordination for implementation of the same.

6.2.3 Outdoor Installation

- (1) All the ducts/ troughs/pipes for laying cables will be provided by the contractor, except the following, which will be provided under Contract Package CP 302:
 - (a) At Junction Stations/Yards
 - (i) 3X200mm dia RCC pipes across the Formation near the centre line of the station yard.
 - (ii) 2X200mm RCC pipe at both ends of the station yard near the facing points for the loop lines.
 - (iii) 1X200mm RCC pipe at both ends of the station yard near the outermost cross overs.
 - (b) At Yards of IR, as required
- (2) All the mounting brackets and accessories shall be corrosion resistant, aesthetically designed to match with all architectural finishes and of sufficient strength to mount the equipment securely.
- (3) If the equipment is installed at locations exposed to direct sunlight, the equipment, mounting brackets, cables and accessories shall be made of materials which are resistant to ultra violet rays.
- (4) All trackside equipment and the mounting method shall be designed in a way to minimize frequency of preventive maintenance and theft and vandalism.
- (5) The Contractor shall submit the following to the Engineer for review at least three months before the commencement of the outdoor installation activities:
 - (i) Specifications, sample of all the mounting brackets and accessories.
 - (ii) Equipment mounting and installation methods and

- (iii) Schematic diagrams and wiring diagrams of the System.

6.2.4 Equipment Cabinets and Enclosures

- (1) The Indoor Equipment Cabinets/ Enclosures housing Signalling Equipment shall conform to IP 54 with Glass doors and Outdoor Equipment Cabinets/ Enclosures / Location boxes shall conform to IP 65.
- (2) The Equipment Cabinets/ Enclosures shall have sufficient EMI/ EMC shielding as required by Signalling equipment inside to remain EMI/EMC compliant. The Cabinets/Enclosures housing Processor based Signalling equipment shall be EMI complaint as per IEC 61587-3.
- (3) The Indoor Cabinets/Enclosures housing Signalling equipment shall be provided with appropriate Ventilation/Cooling arrangement based on Heat Load calculation. The Contractor should get the Ventilation/Cooling arrangement approved by Engineer before supplying the Cabinets/Enclosures for Signalling equipment.”

6.3 SIGNALLING CABLE LAYING, TERMINATION AND TESTING

6.3.1 Signalling Cables

- (1) The Cables for carrying outdoor signalling circuits shall be PVC insulated, PVC sheathed and armoured unscreened cable conforming to IRS specification IRS: S-63/2014. The cable conductor shall be of annealed copper having minimum cross sectional area of 1.5 sq. mm.
- (2) The Cables for carrying Signalling power supplies outdoor shall be PVC – insulated armoured, unscreened, underground power cable as per specification IRS: S-63/2014 & IS: 1554 (Part-1). The size of conductor shall be so selected as to suit the electrical load.
- (3) The Quad cable used for Axle Counter circuit shall be 4/6 quad Telecom underground Jelly filled cable as per IRS specification TC-30/2005.
- (4) The Optic Fibres/channels, as appropriate for the Signalling system shall be provided under PS - Telecommunications Works, Vol. 4, Part 2. The Signalling system shall interface with the Telecommunication system for the same.
- (5) Indoor cable/wire used shall be single/multi core, plain annealed high conductivity copper conductor, PVC insulated unarmoured as per IRS S-76/89. All electronic equipment shall however, be wired as per the requirement of the relevant RDSO specification of the equipment and /or as specified by the OEM. The contractor shall take prior approval of Engineer if indoor cable/wire other than RDSO approved are proposed to be used.
- (6) All cables shall be adequately rated for their current carrying capacity. All power cables shall be able to withstand full load current for peak operation. The Contractor shall comply with the latest edition of IEE Wiring Regulations.
- (7) A labelling scheme shall be applied for all cables installed. Each cable shall be uniquely identified. Labels shall be tied at both ends, at entry and exit points of cable trays, ducts and trenches and at appropriate locations where necessary. Labels shall be provided at about 100 m spacing on complete length of all sizes of cables. Type of labels to be used shall be got approved from the Engineer.
- (8) The DWC-HDPE pipe/duct used for protection of signalling cables below the track or any other place shall be supplied to RDSO specification RDSO/SPN/204/2011.

6.3.2 Cable core allocation

- (1) A cable core distribution plan shall be prepared for each installation.
- (2) Preferably, 6/12/19/24/30 core signalling cables shall only be used to keep low the inventory requirement.
- (3) Adequate spare conductors to a minimum of 20% of the total conductors used shall be provided. All branch/tail cables shall have at least 10% spare cores or 2 cores, whichever is more. The spare conductors shall be provided in the outermost layer. All spare cores shall be made through up to the end points and terminated. Two nos. of 12 core dedicated spare signalling cable may be provided in the station area from Home signal to Home signal and terminated in all locations for instant transfer of these dedicated conductors during cable failure and cable testing.
- (4) Where a number of cables have been used, the circuits shall be so distributed that the cables can be disconnected for maintenance purpose with the least possible dislocation to traffic. Line wise and if necessary function wise cables shall be provided. Auxiliary signals shall be taken in different cables.
- (5) A separate cable shall be used for operation of each point/crossover.
- (6) All the power cables shall have redundancy with main and redundant cables laid in different trenches and forming a ring circuit. In no case, the power cable with Aluminium conductors be used for outdoor Point circuits.
- (7) UP and DN track vacancy detection systems shall be in different cables. Cables for Main and Supervisory Track vacancy detection systems shall be separate. In Block section, if both DPs of a track section are controlled from same ALH, the information between the 2 DPs of the track section and the Evaluator shall be carried in same quad cable. In Station area, the quad cable core allocation among the DPs, to the extent possible, shall be so distributed so as to cause minimum failure of track sections, thereby causing least dislocation to traffic during failure/disconnection of cables for maintenance purpose,
- (8) The Quad cable laid shall have one quad reserved for Emergency communication being provided under PS-Telecommunications Works, Vol. 4, Part 2. The quad cable used for signalling functions and emergency communication shall also have 20% (of the total conductors used) spare conductors.
- (9) The Safety Critical Signalling systems such as EI, MSDAC etc. using OFC system for communication shall use dark fibres exclusively for Signalling use.
- (10) Separate cable shall be used for location lighting. The Location lighting cable shall not carry any other signalling function.
- (11) Spare 12c and 4 quad cables shall be laid and terminated between Location boxes of UP and DN systems at regular intervals of approximately 1 Km, to facilitate use of spare cores of Up system for DN and vice-versa, for restoration during failure.

6.3.3 Cable Route Plan

- (1) After deciding the size and the number of conductors in the different types of cables to be used on a route, a foot survey along the track shall be done to determine the best route for the cable.
- (2) While planning the cable route, any future yard modification etc. shall also be kept in view.
- (3) As far as possible low lying areas, platform copings, drainages, hutments, rocky terrains, points and crossings, shall be avoided.
- (4) The cable route plan shall show the actual alignment of track, giving offsets from permanent way or permanent structures. The diagram shall indicate the various road and track crossings, crossing with power cables, water and sewage lines and other items of importance.
- (5) All cable routes shall be carefully coordinated with all the interfacing parties. The cable trenching work shall be taken in hand only when the cable route plan has been approved by the Engineer.

6.3.4 Storing & transportation of cable

- (1) Cable drums shall not be stacked on flat side. Suitable stoppers shall be placed for stability.
- (2) Cable drums shall have easy access for lifting and moving.
- (3) When rolling the cable drum either for unloading or transportation, the drum shall always be rotated in the direction of the 'arrow' which is marked on the drum.
- (4) The drums shall not be rolled over objects that could cause damage to the protective battens of the cable.
- (5) When unloading is carried out from the vehicle the drum shall not be dropped on the ground directly to avoid damage due to impact. Fork lifter or ramp shall be used.
- (6) During all stages of storage, it is essential that the ends of the cable are effectively sealed by end cap or in any other approved manner to avoid water entry into the cable.
- (7) It is desirable that cable drums are stored in covered shed to protect against direct exposure to sun/rains.

6.3.5 Paying out the cable

- (1) For paying out cables, the cable drums shall be mounted on cable wheels. It shall be ensured that no kink is formed while paying out the cable.
- (2) Cable drum shall never be kept on its side and cable uncoiled since this can result in twisting of cable conductors resulting in damage to them.
- (3) The drum on the wheel shall be brought to one end of the trench and the end of the cable freed and the cable shall be laid along the trench.
- (4) The cable drum shall be brought as close to the cable trench if possible. The cable drum shall clear the ground by 5 to 10 cm.
- (5) The wooden battens on the drums shall be carefully removed shortly prior to laying and before the drum is mounted on the jack.
- (6) A party of labourers shall move along the trench carrying cable at suitable intervals so that cable is not damaged due to dragging along the ground or bent

unduly.

- (7) The in-charge of cable laying shall ensure proper synchronization of all labourers for smooth laying.
- (8) In cases where the wheels are not available, the drum shall be mounted on an axle at one end of the trench and cable paid out and carried by labourers.
- (9) In no case, shall the drum be rolled off on to the road for laying the cable and the cable dragged on the ground for laying purposes.
- (10) Whenever mechanized equipment is used, the work shall be carried out by a trained operator under the supervision of the Engineer or its authorized representative.
- (11) Where the cable drum is in damaged condition the cable may be placed on a horizontal revolving platform and the cable paid out in the same manner as given in paras above.
- (12) Paying out of cable shall be done by rotating the cable drum and not by pulling the cable with excessive force.
- (13) Wherever flaking of cable is required, it shall be done by making a succession of loops in the form of Figure '8', these loops being disposed on top of each other to avoid tangling of cable. Figure of '8' flaking shall only be carried out under the direct supervision of an experienced official.

6.3.6 Excavation and backfilling of the trenches

- (1) Manual trenching is recommended for laying of Signalling cables in the station yards from Home to Home signal and mechanized trenching is recommended from Home signal and beyond into block/automatic section.
- (2) Digging of trench between IR track and DFC track shall be manual or mechanized as proposed by the contractor and approved by the Engineer for every Station & Block section separately.
- (3) Excavation of cable trench shall be made in all kinds of soils including clearing roots of trees, rocks, etc. During excavation, the earth of the trenches shall not be thrown on the ballast. The earth shall be thrown by the side of the trenches away from track.
- (4) Trenches shall be straight as far as possible and steep angles shall be avoided.
- (5) The width of manually made cable trenches shall be commensurate with number of cables. The minimum width shall be kept as 0.3 metres.
- (6) It is desirable that the excavation of the trenches is not done in long lengths and does not remain uncovered for long period. It is preferable that cables are laid and refilling done on the same day.
- (7) Before commencement of the laying, inspection of the trench and inspection of protection works shall be carried out by the Engineer so as to ensure their conformity with the specification.
- (8) After cable has been laid and until the whole of the cables to be laid in the trench have been covered with their protective covers, no sharp metal tool such as spades, crowbar or fencing pins shall be used in the trench or placed in such a position that they may fall into the trench.

- (9) For road/platforms/railway track crossing, trenchless horizontal directional drilling (HDD) technique shall be adopted under the supervision of competent staff for laying of GI/DWC-HDPE pipe. Both ends of GI/DWC-HDPE pipes shall be closed properly using accessories and the pits shall be properly backfilled. There shall be no damage to the road/platform/tracks or any such structures etc. enrouted during or after the HDD operations.
- (10) Backfilling of the trenches shall be done properly. The earth excavated shall be put back on the trench rammed and consolidated.

6.3.7 Cable Laying underground

- (1) The cables may be laid underground, either in the trench, in ducts, in cement troughs, in pipes or in any other approved manner.
- (2) The cables shall generally be laid keeping in view all the relevant provisions of Signal Engineering Manual of IR and the Joint Procedure order for undertaking digging work in the vicinity of S&T underground cables (Annexure-I of Appendix 3).
- (3) Before commencing work on any part of the site, the Contractor shall ascertain that the Engineer and also, where applicable, the local and statutory authorities or other bodies/persons concerned have reviewed the cable route. The Contractor shall further ensure that all necessary permits in such cases have been obtained and notices served.
- (4) Every precaution shall be taken to ensure that cables and equipment are not installed in a manner or under conditions likely to cause electrolytic or other corrosive action or damage to, or be detrimental to, the performance of the cables and equipment during operation.
- (5) Signalling cables shall not run with cables carrying high voltages or heavy currents and shall conform to the requirements specified in BS 7671.
- (6) Signalling tail cables shall be mechanically protected to avoid being damaged from track side maintenance activities and shall be immune to any malfunction from electromagnetic interference.
- (7) All cables shall be laid along the track preferably one metre inside the EDFC boundary. If it is necessary to lay the cable outside the EDFC boundary, permission shall be obtained before starting the trenching.
- (8) The cable laid parallel to the track shall be buried at a depth of minimum 1.0 metre (top most cable) from ground level. However, in case of rocky soil, the depth may be reduced suitably. When it concerns the laying of tail cables which serve the track apparatus etc., the depth shall not be less than 0.50 metres.
- (9) No sharp object like stone chips, iron pieces etc. shall ever come in contact with laid cables irrespective of the method of laying the same. The bottom of the cable trench shall be levelled and got rid of any sharp materials. In the soft ground, the cable shall be laid at the bottom of the trench previously levelled. In both the above cases, the cable shall be covered with a layer of sand or sifted earth of 0.10 metre thickness and thereafter a protective cover of trough or a layer of bricks shall be placed.
- (10) A typical arrangement of Cable Trench is shown in sketch no. SDO/CABLE LAYING/003 at Annexure-III of Appendix 3.

- (11) A typical arrangement of position of trenches for cable laying in Station area and Block Section has been shown in sketch No. GGM/Signal/Indicative drawing No. 1 and GGM/Signal/Indicative drawing No. 2 placed at Annexure-II (a) of Appendix 3 and Annexure-II (b) of Appendix 3 respectively
- (12) The cables used for providing redundancy/ring circuit in signalling circuits shall be laid in different trenches/ducts, separated by DFCCIL/IR track(s). In case, if site conditions necessitate that the trenches/ducts are to be made on the same side of DFCCIL track (not separated by DFCCIL/IR track(s)), then it should be done with the prior approval of the Engineer with two trenches made with separation of at least 4 metres, and trench/duct farther from the DFCCIL track having depth of 1.7metres. Wherever 4 meters separation is not available/achievable, the cable laying shall be done as proposed by the Contractor and approved by the Engineer.
- (13) At each end of the main cable an extra loop length of 6 to 8 metre shall be kept.
- (14) Before starting cabling work, location boxes shall first be erected so that cable after laying is directly taken inside location box and its multiple handling/damage by re-digging and taking inside location box/Relay Room is eliminated.

6.3.8 Cable Laying in Electrified area

- (1) The cable shall be laid at not less than one meter from the nearest edge of the mast supporting the catenary or any other live conductor, provided the depth of the cable does not exceed 0.5 meters. When the cable is laid at a depth greater than 0.5 metres, a minimum distance of 3 metres between the cable and the nearest edge of the O.H.E. structure shall be maintained. If it is difficult to maintain these distances, the cable shall be laid in concrete/heavy duty HDPE/Ducts or any other approved means for a distance of 3 metres on either side of the Mast. When so laid, the distance between the cable and mast may be reduced to 0.5 meters. The precautions are necessary to avoid damage to the cable in the event of the failure of an overhead insulator.
- (2) In the vicinity of traction sub stations and feeding posts, the cable shall be laid at least one metre away from any metallic part of the O.H.E. and other equipment at substation, which is fixed on the ground, and at least one metre away from the substation earthing. In addition, the cable shall be laid in concrete or heavy duty HDPE pipes/or other approved means for a length of 300 metres on either side of the feeding point. As far as possible, the cable shall be laid on the side of the track opposite to the feeding post.
- (3) In the vicinity of the switching stations, the cable shall be laid at least one metre away from any metallic body of the station, which is fixed in the ground, and at least 5 metres away from the station earthing. The distance of 5 metres can be reduced to one metre provided the cables are laid in concrete pipes/heavy-duty HDPE pipes/ducts or any other approved means.
- (4) Where an independent Earth is provided for an OHE structure, i.e. where the mast is connected to a separate Earth instead of being connected to the rail, the cables shall be laid at least one metre away from the Earth.
- (5) Where there are O.H.E. structures along the cable route, the cable trenches shall as far as possible, be dug not less than 5.5 metres away from the centre of the Track.

6.3.9 Laying of different type of cable in same trench

- (1) The OFC cable shall be laid in HDPE pipe as per Telecom manual. The cables other than OFC shall be laid directly in the trench (both Signalling & Telecom cables).
- (2) Where several cables of different categories have to be laid in the same trench, they shall be placed as far as possible in the following order starting from the main track side, so that in the event of failures, the maintenance staff may easily recognize the damaged cables:-
 - (i) Telecommunication cable
 - (ii) Signalling cable
 - (iii) Power cable
- (3) A distance of approximately 10 cm must be maintained between telecommunication cable and signalling cables. The signalling cables must be separated from power cables by a row of bricks between them.

6.3.10 Cable laying in ducts

- (1) When cables are laid in rocky area, it is desirable to protect them with split RCC ducts of suitable design.
- (2) Cables for longer distances shall be laid on bottom layer. Duct shall be filled with sand after cable is laid to avoid entry of rodents.
- (3) The ducts shall be of such design as to prevent collecting the water in the duct.
- (4) Cables in any conduits, trunkings or ducts shall not occupy cross-sectional space in excess of 50%.
- (5) When cables are laid in trunking, care shall be taken to see that no ballast or stones have been dropped inside the trunking. The trunking shall be cleared of all ballast and stones before the cover are secured. When the ends of covers are joined together with cement plaster, a piece of paper or wood shall be placed under the joint to prevent the cement plaster from falling on the cable.
- (6) After placing the trunking in the trench the ducts have to be aligned using 8 mm rod. For this purpose, a hole is left in the trunking for insertion of rods. Wherever there is a diversion proper care shall be taken to cover the cables, either by smoothly forming a curve with duct or a masonry structure can be constructed to protect the cables. After laying of cables the ducts shall be covered with RCC slab and shall be continuously plastered at the end with trunking.
- (7) Where it is necessary to take the cables between the tracks, it shall be carried in trunking kept sufficiently below the ballast level.

6.3.11 Cable Laying in Solid & Rocky soil

- (1) In case of rocky soil, the depth may be reduced suitably.
- (2) Sharp edges on the sides must be smoothed out and bottom of the chase shall be levelled. In the rocky ground the cable shall be laid normally on layer of sifted earth of 0.05 metres thickness previously deposited at the bottom of the trench. Cable shall be covered with the layer of sand or sifted earth of 100 mm thickness.
- (3) In case sharp edge of rocky ground cannot be protected with sifted earth, concrete/GI/CI/PVC/DWC-HDPE pipe shall be used if numbers of cables are small. If number of cables is large, RCC duct shall be used. In isolated cases, it can be given smooth surface by using either masonry bricks or cement concrete.

- (4) A row of bricks shall then be placed lengthwise on the top and jointed with cement mortar and a layer of concrete with cement plaster shall be provided on the top of the same.
- (5) A sketch No. SDO/CABLE LAYING/008 showing laying of cables in rocky area is placed at Annexure-IV of Appendix 3.

6.3.12 Laying in special soil condition

Cable shall not be run through abnormally high acidic or alkaline soil or through sewages. If this is unavoidable special measures shall be taken to prevent corrosion. Cable may be laid in the concrete/GI/CI/PVC/DWC-HDPE pipes properly jointed to prevent ingress of moisture.

6.3.13 Cable laying in residential area

When laying the cable in residential area, the cable shall be specially protected on both sides up to a distance of about 300 metres beyond the building line. In such cases, the cable shall be protected by means of concreting of 50 mm as proposed for rocky soil. This is better than using bricks as in a residential area bricks are usually found while digging and its special significance of cable protection may be overlooked.

6.3.14 Track crossing

- (1) As far as possible, the cable shall be crossed from one side of the yard to the other, at minimum number of locations.
- (2) Track crossing shall be through trenchless method. The following precaution shall be taken:
 - (a) The cable crosses the track at right angles.
 - (b) The cable does not cross the track under points and crossings.
 - (c) The cable is laid in concrete/GI/CI/PVC/DWC-HDPE pipes or suitable ducts or in any other approved manner while crossing the track.
 - (d) Cable laid across the track must be 1.0 metre (minimum) below the ground level.
 - (e) No digging shall be done below the sleepers.
 - (f) A sketch No. SDO/CABLE LAYING/009 showing track crossing is placed at Annexure-V of Appendix 3.

6.3.15 Road crossing

- (1) Road crossing shall be done through trenchless method. The cable shall be laid in concrete/GI/CI/PVC/DWC-HDPE pipes or in any other approved manner while crossing the road at the depth of 1 metre from the ground level. It shall extend 1 metre (minimum) on each side of the road keeping in view the future increase of width of the road.
- (2) When crossing roads, it is necessary to lay the cables in such a manner as to avoid the necessity of bending the cable sharply and minimize the excavation of road surface as far as possible.
- (3) The crossing of main roads often involves difficulties, especially if traffic is heavy. Precautions to avoid accidents to workmen, pedestrians and vehicles shall be taken. On minor roads, which can be temporarily closed to traffic it is possible to open up across the entire width of the road, pipes shall be installed quickly in the

cutting, which is then filled in there by reducing to a minimum the time for which the road is closed.

- (4) Some roads, which are broad, may be opened for half their width allowing the other half for use of traffic, pipes are laid, trench filled in the first half and the other half opened up after the first half is opened half is linked with those laid in the first half.
- (5) Whenever a cable is laid across an important road, particularly one with a special surface, space for future expansion may be provided. Either of the following methods may be adopted:-
 - (a) The size of the pipe shall be so chosen that provision for laying of additional cables in future is kept. Pipes having diameters ranging from 100 to 200 mm are suggested, or
 - (b) A spare pipe may be laid, through which a cable can be drawn when required. It will be advantageous to leave a lead wire of G.I wire in the pipe for drawing the cable in future.
- (6) A separate pipe of suitable diameter shall be used for telecommunication cable.
- (7) A sketch No. SDO/CABLE LAYING/010 showing road crossing is placed at Annexure-VI of Appendix 3.

6.3.16 Cable laying on bridges/culverts

- (1) Wherever practicable, the cable may be taken underground across the drain bed at a suitable depth for crossing small culverts with low flood level. A sketch No. SDO/CABLE LAYING/011 showing cable laying on culverts with low flood level is placed at Annexure-VII of Appendix 3. Wherever cable may not be taken underground across the drain bed, cable shall be taken on the culvert through GI/DWC-HDPE pipe of suitable sizes. A sketch No. SDO/CABLE LAYING/012 showing cable laying on culverts with high flood level is placed at Annexure-VIII of Appendix 3. The CST contractor (CP - 302) is to provide ducts on the concrete bridges and culverts. The same may be used by the contractor for laying of S&T cables.
- (2) When cables have to cross a metallic bridge, they shall be placed inside a metallic trough which may be filled, as an anti-theft measure, with sealing compound. The cable shall be supported across the bridge in a manner which would involve minimum vibrations to the cable and which will facilitate maintenance work. Adequate cable length to the extent 2 to 3 meters shall be made available at the approaches of bridge. A sketches No. SDO/CABLE LAYING/013 & 014 showing cable laying on metallic bridges are placed at Annexure-IX & Annexure-X of Appendix 3.
- (3) In case of arch bridges, cable shall be taken through GI/DWC-HDPE pipes on top of the arch adjoining the parapet wall. The pipe shall be covered with ballast.
- (4) Concreting of 50 mm shall be done throughout from entry/exit end of cable up to diversion point including slope on either side. The entry and exit ends of the cable from the pipe to the diversion point of the cable shall be concreted for 1 metre (minimum).
- (5) As the laying involves movement of a large number of staff over the bridge the line shall be blocked and flagman posted on other side. On a double line only the line near which cable is being laid shall be blocked but care shall be taken to see that

staff is aware of this and measures taken to prevent staff from straying on to the unblocked line.

- (6) Damage to cable is likely to occur if care is not taken in laying cable where the bed changes from solid support such as a foundation, pier of bridge to soft support such as soft soil. The cable must not press against the edge of the solid support. The soft soil near the edge must be tamped and the cable raised slightly.
- (7) In order to prevent theft and miscreant activities on approach of cable to bridge/culvert where it is not possible to ensure adequate depth, concrete protection is proposed.

6.3.17 Cable Laying in monsoon season

- (1) Cable laying in monsoon when the precipitation is heavy shall be avoided. The trenches will be inundated and visual inspection of the bedding of the trench will be rendered difficult. Threading the cable in pipes will also be more difficult.
- (2) When cable laying is necessary during the rainy season, the cable ends shall be inserted in a pipe sealed at one end and the pipe buried. Termination work shall be started only when there is likelihood of a clear weather for three to four days.

6.3.18 Laying of cable above ground

- (1) Signalling cables for outdoor circuits shall not normally be laid above ground. In exceptional cases where it becomes unavoidable, the following precautions shall be taken:
 - (a) The cable shall be suspended in wooden cleats, from cable hangers or in any other approved manner so that no mechanical damage occurs to the cable even under exposed condition.
 - (b) The cable supports shall be so spaced as to avoid sag.
- (2) Indoor signalling cable shall normally be laid on ladders, channels or in any other approved manner. The cables shall be neatly tied/ laced.
- (3) In AC electrified areas cables shall be laid underground only. For laying cables in RE area instructions laid down in Chapter XXII of SEM shall also be followed.
- (4) All cables in OCC being provided in false floor shall be neatly secured on cable channels

6.3.19 Cable markers

Underground Cable Route shall be identified by Electronic Cable Markers directly buried inside the trench at 30-40 m interval and at diversion points with the approval of Engineer. Electronic cable marker should be robust, non-rusting & water proof. It shall be possible to trace their location with the help of a cable marker tracing unit up to a depth of 1.5 meters.

6.3.20 Entry of cable at cabin, relay room, location boxes etc.

- (1) All cable entry points in the Equipment room, battery room, SM's room, location boxes, junction boxes etc. shall be sealed using modular based cable and pipe sealing system based on multi-diameter technology as per RDSO specification circulated vide letter no. STT/OFC/Misc/263/Vol. XIV dated 03.01.2008. The modules shall be made of low smoke index, halogen free cross linkable rubber compound based on EPDM (Ethylene-Propylene Diene Ter-Polymer). A multi-diameter sealing module shall consist of two halves with removable layers and a

centre core. One single module shall be able to seal cables of different diameters by peeling off layers. The sealing system must have built-in spare capacity i.e. option for adding more cables into the same system. All cable entries from/to adjacent rooms through overhead duct/ladder shall also be sealed.

- (2) All cable entrance ducts must be closed with suitable masonry works, sand covered and plastering to prevent entry of rats etc. RCC slab shall be provided on the cable pit of the Signalling equipment rooms at the Station and auto location huts.
- (3) Cable shall be protected on both sides up to a distance of 10 metre beyond building line of Signalling equipment rooms and battery room SM's room. In case of location/junction boxes, etc. cable may be protected for 1 metre on each side.
- (4) Damage to cable is likely to occur if care is not taken in laying cable where the bed changes from solid support such as a foundation/masonry to soft support such as soft soil. The cable must not press against the edge of the solid support. The soft soil near the edge must be tamped and the cable raised slightly.

6.3.21 Termination of cables

- (1) No jointing of cables is permitted. All cables shall be terminated.
- (2) The cable termination of signalling cables shall be undertaken on approved type terminations on CT racks/ location boxes/junction boxes.
- (3) All wire and cable conductors shall be clearly identified and numbered at each end using durable shrink on or tag type labels. A description of the terminating function shall be included. Each core so terminated shall be provided with identification marking on cable and on conductors/terminals and ferrules with letters or/numbers embossed on them as per requirement of circuitry. This will enable easy identification of conductors in case of any failures or cable disconnections or cable cut by outsider/miscreants. A proper marking and termination practice ensures quick and easy restoration during failures.
- (4) Unused cable cores/pairs of multi-core/pair cables shall also be terminated and marked so.
- (5) Crimping or other standard industry practice shall be used for terminating all conductors. Solder terminations shall only be used with the approval of the Engineer.
- (6) Wherever practical, multiple pin plugs and sockets shall be used to connect multi-core cables and wiring loops to all items of equipment. These shall have some form of keying to prevent incorrect equipment modules from being installed.
- (7) The cable terminations shall be secured enough to withstand vibration level that is likely to be experienced in the DFCCIL environment.

6.3.22 Cable Termination Rack (CTR) and Location Box

- (1) Cable Termination Rack (CTR) with 20% extra capacity for future expansion shall be provided.
- (2) Only screw less terminals with isolation facility shall be used for cable terminations. The terminals and fuses used shall meet the requirements of RDSO specification No RDSO/SPN/189/2004. If any alternative terminal type is proposed for use, it should be got approved by Engineer.

- (3) All external power/ signalling / data lines susceptible to lightning or high induced voltage shall be provided with Stage 3 surge protection devices as per Para 6.4.5(4)(c) of this specification.
- (4) The Cable Termination Rack (CTR) shall be equipped with copper earth bar to which all cable shields shall be connected and soldered. The copper earth bar shall be connected to the earth.
- (5) The Outdoor cables shall be terminated in Location Boxes.
- (6) Location boxes shall be rugged and free from ingress of rodents, insects, dust, moisture and water.
- (7) Location boxes shall be able to withstand vibration level, likely to be experienced alongside the track.
- (8) Location boxes shall be theft and vandal proof as far as possible and shall be able to withstand the climate of the region.
- (9) Cable entry points in the location boxes shall be filled with sand and plastered with cement.
- (10) Separate Location boxes shall be used for UP and DN line cables.
- (11) Where too many location boxes (say more than 10) are in close proximity between Starter and Home signal, location huts may be provided instead of location boxes for security, proper protection and ease of maintenance.
- (12) All location boxes shall be provided with 110 V AC lighting arrangement with ON/OFF switch to assist maintenance/repair work undertaken during night. The cable for Location Lighting shall be separate, and carry no other signalling function.
- (13) The foundation of Location boxes shall not be done on loose earth. It should be installed on concrete foundation. The foundation drawing shall be proposed by the Contractor and approved by the Engineer.

6.3.23 Testing of cable

- (1) Before the cable is laid in the trench, a visual inspection of cable shall be made to see that there is no damage to the cable. It shall be tested for insulation and continuity of the cores. Thereafter, the cable shall be laid into the trench. Record of insulation and loop resistant must be maintained.
- (2) Testing of all main and tail cables after laying of the cable in trenches and also after termination in apparatus cases, in boxes and relay room shall be done.
- (3) If any defect is noticed during the testing after laying the cable the same shall be replaced.
- (4) The insulation resistance tests shall be made when conductors, cables and insulated parts are clean and dry. A 500V insulation tester shall be used for insulation testing. Any metallic sheath or metal work of any rack or apparatus case shall be bonded to earth during test.
- (5) Insulation Resistance so measured shall not be less than 5 mega ohms per km at buried temperature. If the insulation resistance is found to be lower than 5 mega ohms, the cause shall be investigated and immediate steps taken to repair or replace the cable to prevent any malfunctioning of the equipment and circuits.

6.3.24 Supervision of cable laying

The work shall be supervised personally by an official authorized by the Engineer. The cable trench shall be inspected by the authorized person and jointly signed by him and the Contractor's authorized person before cable laying is undertaken. The record of joint inspection of the trench shall be maintained.

6.3.25 Earth Leakage Detector (ELD)

- (1) ELD shall be provided to detect earth faults in the Signalling cables and circuits.
- (2) ELD and alarms shall be provided at all the Signalling equipment rooms at the stations, block sections and at the OCC.
- (3) ELD provided should cover all the Signalling cables and power cables.

6.4 EARTHING AND BONDING

6.4.1 General

- (1) Earthing shall be provided for all Indoor & Outdoor Signalling installations to achieve the following objectives:
 - (a) Efficiently dissipate heavy fault currents and electrical surges, both in magnitude and duration, to protect equipment from being damaged so as to minimize down time, service interruption and replacement cost.
 - (b) Provide a stable reference for electrical and RF circuits at the installation to minimize noise during normal operation.
 - (c) Protection of personnel who work within the area from dangerous electric shock caused due to "step potential" or "touch potential".
- (2) To achieve the primary goal of assuring personnel safety and damage control, a low impedance path shall be made available to the current generated due to lightning or power system fault. The potential differences between any two points shall be as low as possible. Safety considerations also require the equipment chassis or enclosure to be earthed to minimize shock hazards to system staff.
- (3) To achieve the secondary goal of providing protection for sensitive and interconnected electronic and electrical systems, earthing shall be designed to minimize the noise voltage generated by currents from two or more circuits flowing through common earth impedance and to avoid creating earth loops susceptible to magnetic fields and differences in earth potential.
- (4) The Earthing and Bonding system shall meet or exceed the requirements of IEEE 1100, NFPA 780, IEC 62561-7 and IEC 62305.
- (5) To minimize the effect of circulating earth loops and to provide equipotential bonding, "star type" bonding connection shall only be provided as required.
- (6) The contractor shall submit the design for Earthing and Bonding of Signalling and Telecommunication systems for review and approval by the Engineer. OEM's original data sheets of the proposed devices shall also be submitted along with the protection methods adopted in their design.

6.4.2 Indoor Signalling installation

- (1) The Equipment rooms housing Indoor Signalling equipment and their Power supply shall be provided with suitable Earthing and Bonding system. A typical Earthing and bonding arrangement for Indoor signalling installation is placed at

Annexure-I of Appendix 5.

- (2) There shall be one equi-potential earth busbar for each of the equipment rooms viz. Signal equipment room, Power supply equipment room etc. The equi-potential earth bus bars located in individual rooms shall be termed as Sub equi-potential busbars (SEEB). The equi-potential earth bus bar located in the Power supply equipment room directly connected to Class 'B' SPD and the main earth pit shall be termed as Main equi-potential earth busbar (MEEB).
- (3) The EEB shall have pre-drilled holes of suitable size for termination of bonding conductors. The EEB shall be insulated from the building walls using low voltage fire resistant insulators. All terminations on the EEBs shall be using copper lugs with spring washers.
- (4) All the equipment/racks in the Equipment room shall be directly connected to its SEEB. Each of Sub-equipotential earth busbar (SEEB) installed in the rooms shall be directly connected to Main equipotential earth busbar (MEEB) using bonding conductors.
- (5) The routing of bonding conductors from equipment/racks to SEEB and from SEEB to MEEB shall be as short as possible and direct with minimum bends and separated from other wiring. The connection from SPD to MEEB shall be as short as possible and preferably without any bend.
- (6) The connection between any two moving parts, like doors with Bonding Ring Conductor, etc. shall be connected by 316L Stainless Steel Flexible braids, which are UL listed, RoHS compliant and meeting IEC 60439.1 & IEC 61439.1.
- (7) All bonding connections, whether it is from equipment or SPD to respective lugs on bus bars or of the Main earth bond with the Main Earth electrode, shall be with stainless steel nuts and bolts and exothermic welding while keeping in mind the conditions of UL listing, IEEE 837 & tamper proof weld metals.
- (8) The Earthing system shall use maintenance free loop earth as per specification RDSO/SPN/197/2008 and shall be designed to give an earth resistance of less than 1 ohm. The design should be based on calculation methods as per IEEE 80 which require the parameters like target ohmic resistance value, soil resistivity, electrode length, electrode diameter etc.
- (9) The earth electrode shall be made of high tensile low carbon steel circular rods, molecular bonded with copper on outer surface to meet the requirements of UL 467. The Ground Enhancement material should meet the requirement of IEEE 80's Clause 14.5 (d) and should be tested as per IEC 62561-7 standard. All the earth electrodes shall be bonded together using Galvanized Steel tapes or Copper Bonded Steel Conductors of suitable size in continuous length of max. up to 100 metre to achieve equipotential bonding.
- (10) Despite the provision of earthing, as specified above, if failures of Solid state electronic equipment occur on account of finite earth resistance, particularly due to high voltage transients and lightning, further protection as necessary shall be provided.

6.4.3 Outdoor Signalling installation

- (1) All the Outdoor Signalling equipment viz. Signals, Location boxes, Lifting barriers, track devices etc. shall be provided with suitable Earthing arrangement.
- (2) The target earth resistance value for outdoor Signalling equipment shall be in

accordance with the requirement specified for the equipment by the OEM/RDSO specification.

- (3) The Signalling equipment having Solid State components and the enclosures housing them shall be provided with maintenance free earth using copper bonded steel electrode, earth enhancement compound and bonding connection through exothermic welding as per specification RDSO/SPN/197/2008.
- (4) In order to arrive at the required target resistance value, the number of earth electrodes should be decided based on the calculations involving soil resistivity as per the standards above, all interconnected in parametric ring form or in parallel manner.
- (5) Where the equipment to be earthed are in close vicinity they should be connected to a common earth in star configuration.
- (6) For outdoor signalling items installed in Location boxes, one earth busbar of suitable size shall be provided in each location box and earth point of all equipment and cable armour etc. shall be terminated on this busbar.
- (7) GI wire as earthing bond shall not be used.
- (8) A typical Earthing, Bonding and Surge protection arrangement for location boxes housing Electronic equipment is placed at Annexure-II of Appendix 5.

6.4.4 Lightning Protection

- (1) All the structures housing Signalling and Telecom equipment viz. SER, TER and S&T Power supply Equipment rooms, shall be provided with lightning protection arrangements and protection against lightning surges travelling through conductors into equipment by using appropriate devices.
- (2) The external Lightning protection arrangement shall have an air termination system, down conductors and Earthing system complete with accessories.
- (3) The Lightning Air Terminal should be installed at a height at least 3m more than the top most projection of the building. In case there is a VHF antennae installed on the building, the lightning protection should be so designed to safely overcome the competing features of the antennae as well as any other higher projections on the building.
- (4) The air termination system shall be connected to the earth electrode of earthing system using down conductor of Copper Bonded Steel Conductor or any other suitable material as approved by the Engineer. The Down conductors shall be installed straight and vertical such that they provide the shortest and the most direct path to the earth.

6.4.5 Surge Protection

- (1) The Surge protective devices shall be provided at the input and output power supplies to protect the Power supply equipment and the load equipment against any power surge due to lightning, switching, etc. The Surge arrestors shall also be provided for protection on external power/signalling/data lines.
- (2) All surge protection equipment shall be grouped together in close proximity to the main earth bus bar and be physically and electrically isolated from other signalling equipment.
- (3) The Surge Protection System provided to withstand the surge voltages shall be complying with IEC standards 62305, 61643, 60364.

- (4) Surge Protection for Indoor Signalling equipment shall be provided as under:
- (a) **Stage 1 Protection (at the input 230V AC supply in the power supply equipment room)**
- (i) The Stage 1 protection shall consist of coordinated Class I/ B & II/ C type SPDs at the entry point of input 230V AC supply in Power supply Equipment room in TT configuration in a separate wall mountable box. The Class I/B SPD shall be provided between Line to Neutral & Neutral to Earth. There shall be a voltage switching device and tested as per IEC 61643 with the following characteristics and features:

SN	Parameters	Limits	
		Between Line & Neutral	Between Neutral & Earth
1	Nominal Voltage (U_0)	230V	230V
2	Maximum continuous operating voltage (U_c)	$\geq 255V$	$\geq 255V$
3	Lightning Impulse current 10/350 μs (I_{mp})	$\geq 25KA$	$\geq 50KA$
4	Response time (T_r)	$\leq 100 \text{ ns}$	$\leq 100 \text{ ns}$
5	Voltage protection level (U_p)	$\leq 2.5KV$	$\leq 2.5KV$
6	Short circuit withstand and follow up current extinguishing capacity without back up fuse (I_{sc} & I_{fl})	$\geq 3KA$	$\geq 100A$
7	Temporary Over Voltage (U_T)	334Vmin. for 05 secs.	1200V min. for 200ms
8	Operating temperature / RH	- 25°C to + 80°C/ 95%	- 25°C to + 80°C/ 95%
9	Mounted on	din rail	din rail
10	Indication	Mandatory	Optional
11	Pluggability	Optional	Optional
12	Potential free contact for remote monitoring	Optional	Optional
13	Encapsulation	Encapsulated	Encapsulated
14	Degree of protection	IP20	IP20
15	Housing	Fire retardant as per UL 94	Fire retardant as per UL 94

- (ii) The Class I/ B SPD will be followed by Class II/ C SPD adjacent to it and connected between Line & Neutral. The device shall be a single compact varistor of proper rating and in no case a number of varistors shall be provided in parallel. It shall be voltage clamping device, thermal disconnecting type and shall be tested as per IEC 61643 with the following characteristics and features: -

SN	Parameters	Limits (between Line & neutral)
1	Nominal Voltage (U_0)	230V
2	Maximum continuous operating voltage (U_c)	$\geq 300V$
3	Nominal discharge current 8/20 μs (I_n)	$\geq 10KA$
4	Maximum discharge current 8/20 μs (I_{max})	$\geq 40KA$

SN	Parameters	Limits (between Line & neutral)
5	Response time (Tr)	≤ 25 ns
6	Voltage protection level (Up)	≤ 1.5 KV
7	Operating temperature / RH	- 25°C to + 80°C/ 95%
8	Mounted on	Din rail
9	Indication	Mandatory
10	Pluggability	Mandatory
11	Potential free contact for remote monitoring	Mandatory
12	Degree of protection	IP20
13	Housing	Fire retardant as per UL 94

- (iii) Class I/B and Class II/C SPDs of Stage I shall be so coordinated that the voltage protection level of the coordinated devices is ≤ 1.5 KV. As such, these devices shall be from the same manufacturer and necessary test certificate in this regard shall be submitted by the manufacturer/ supplier.

(b) Stage 2 Protection (Power line protection at Equipment level)

The Stage 2 protection shall consist of provision of Class II/ C type SPDs on 24V-110V AC/DC supplies at Equipment input level for protection against low voltage surges. The Class II/C type SPD shall be provided between Line to Neutral & Neutral to Earth. The device between Line to Neutral shall be a single compact Varistor of proper rating and in no case a number of Varistors shall be provided in parallel. It shall be voltage clamping device and thermal disconnecting type. The device between Neutral to Earth shall be a voltage switching device of proper rating. They shall be tested as per IEC 61643 with the following characteristics and features-

SN	Parameters	Limits	
		Between Line & Neutral	Between Neutral & Earth
1	Nominal Voltage (U _o)	230V	230V
2	Maximum continuous operating voltage (U _c)	≥ 300V	≥ 255V
3	Nominal discharge current 8/20μs (I _n)	≥ 10KA	≥ 10KA
4	Maximum discharge current 8/20μs (I _{max})	≥ 40KA	≥ 40KA
5	Response time (Tr)	≤ 25 ns	≤ 100 ns
6	Voltage protection level (Up)	≤ 1.5 KV	≤ 1.5 KV
7	Operating temperature / RH	- 10°C to + 60°C/95%	- 10°C to + 60°C/95%
8	Mounted on	DIN rail	DIN rail
9	Indication	Mandatory	Optional
10	Pluggability	Mandatory	Mandatory
11	Potential free contact for remote monitoring	Mandatory	Optional

12	Degree of protection	IP20	IP20
13	Housing	Fire retardant as per UL 94	Fire retardant as per UL 94

(c) Stage 3 protection (Protection for Power/ Signalling/ Data lines)

- (i) All external Power/Signalling/Data lines shall be protected using preferably pluggable Stage 3 surge protection devices, consisting of a combination of Varistors/Suppressor diodes and GD tubes with voltage and current limiting facilities.
- (ii) These devices shall preferably have an indication function to indicate the prospective life and failure mode to facilitate the replacement of failed SPDs. If the device has any component which comes in series with data/signalling lines, the module shall have make before break feature so that taking out pluggable module does not disconnect the line. This protection shall be in compliance to IEC 61643-21 & VDE 0845 Pt. 3 with the following characteristics:

Nominal Voltage (U_0)	5 V	12 V	24 V	48 V
Arrestor Rated voltage (U_c)	6 V	13 V	28 V	50 V
Rated Load current (I_L)	≥ 250 mA	≥ 250 mA	≥ 250 mA	≥ 250 mA
Total discharge current 8/20 μ s (I_n)	≥ 20 kA	≥ 20 kA	≥ 20 kA	≥ 20 kA
Lightning test current 10/350 μ s	≥ 2.5 kA	≥ 2.5 kA	≥ 2.5 kA	≥ 2.5 kA
Voltage protection level (U_p)	≤ 10 V	≤ 18 V	≤ 30 V	≤ 70 V

- (iii) If the Power supply/Data/Signalling lines (AC/DC) are carried through overhead wires or cables above ground to any building or any location outside the equipment room, additional protection of Stage 2 (Class II/C) type shall be used at such locations for power supply lines and Stage 3 protection for Signal/data lines.

(End of Chapter 6)

CHAPTER 7: TESTING AND COMMISSIONING

7.1 GENERAL

7.1.1 The general details of Testing and Commissioning Philosophy, Strategy, Program, Plan and procedures is covered in General Specifications, Volume 1 Part 2. The specific requirements of Testing and Commissioning covered here shall be read in conjunction with the general requirements covered in the GS.

7.1.2 All costs associated with Testing shall be borne by the Contractor. This shall include the Testing/Inspection charges to be paid to RDSO/RITES/Test Laboratories. The Contractor shall bear any expense incurred due to resetting/retesting caused by defects of material or failure of equipment to meet the requirements of contract in first instance. The costs incurred by Engineer and/or Employer's Personnel against hotel and travel expenses for witnessing of testing shall not be borne by the Contractor.

7.1.3 Sequence of Tests

The sequence of tests shall generally comprise of the following:

- (1) Type Tests, as and when required;
- (2) Factory Acceptance Tests (FAT);
- (3) Installation Tests;
- (4) System / Sub-system Acceptance Tests (SAT);
- (5) Integrated Testing & Commissioning; and
- (6) Trial Run.

7.2 TYPE TESTS

7.2.1 Type tests are performed on sample of Equipment prior to full production. Type tests are used to confirm that the proposed equipment is fit for purpose in the environmental conditions specified and meets the requirements of the specification including the EMC.

7.2.2 Type tests are not required to be conducted on Equipment procured as per Para 5.2.3 of this specification.

7.2.3 Type tests may be performed on Equipment procured as per Para 5.2.4 and 5.2.5 of this specification. However, the Type tests may be exempted if the Contractor is able to produce the Environmental and EMC test results earlier conducted on the Equipment and RDSO/DFCCIL are satisfied that the Equipment meets the required specification.

7.2.4 Type tests on equipment for which RDSO specification exists, if required shall be done as per applicable RDSO specification.

7.3 FACTORY ACCEPTANCE TESTS

7.3.1 The FAT is carried out to demonstrate that each equipment/sub-system meets its functional specifications.

7.3.2 The FAT shall be carried out on all material, components, sub-assemblies, unit assemblies (including software, cables and wiring). No equipment or software shall be delivered to the Site until the Contractor has demonstrated, to the satisfaction of the Engineer that the equipment or software conforms to the specifications by carrying out

the FAT. If any item/equipment whether as per IRS/RDSO specification or otherwise is proposed to be procured without FAT, the same should be done only with the prior approval of the Engineer.

7.3.3 FAT procedure shall be submitted for review by the Engineer Twenty Eight (28) days in advance of carrying out any Test.

7.3.4 The FAT shall be witnessed by Engineer/Employer's representative.

7.3.5 Where processor based equipment is to be used, the FAT shall also include verification of application software.

7.3.6 Factory acceptance tests shall include but not limited to:

- (1) Physical inspection;
- (2) Layout and equipment profile;
- (3) Dimension check;
- (4) Electrical check;
- (5) Calibration;
- (6) Output check;
- (7) Operational performance;
- (8) Insulation test;
- (9) Soak test; and
- (10) Interface tests with other equipment.

7.3.7 The EI application logic/software for every station and auto section will have to be tested completely for all tests including Control Table, Hot standby tests etc. as part of FAT. The controls/logic that are not possible to test at the FAT stage shall be identified and tagged for testing at SAT stage, in consultation with the Engineer.

7.4 INSTALLATION TESTS

7.4.1 Prerequisites for Installation:

- (1) Prior to installation, the Contractor shall ensure that equipment delivered to Site has not been damaged in transit and ensure for their dimensional accuracy.
- (2) The Installation designs and drawings have been reviewed and approved by the Engineer.

7.4.2 Post Installation tests and Inspection:

- (1) Post installation tests shall be carried out by the Contractor for each sub system following installation but before functional tests to demonstrate that the installation has been carried out correctly.
- (2) The Contractor shall carry out installation tests for each sub-system following Installation but before SAT to demonstrate that the installation has been carried out correctly and equipment is properly housed and fixed.
- (3) The Installation shall be inspected by the Contractor and witnessed by the Engineer. The Contractor shall submit a Post installation Inspection and testing Plan for Engineer's approval, prior to commencement of Post Installation inspection and testing.

- (4) During the inspection, it shall be verified that
 - (a) The equipment has been installed as per the procedures and designs and drawings that have been reviewed by the Engineer and that equipment is correctly located and labelled.
 - (b) Any false feed, temporary wiring and redundant items have been removed and that equipment is correctly protected against interference, damage and deterioration.
- (5) The Contractor shall submit Installation Checklist of individual items/equipment/subsystems based on the designs and submit it for Engineer's review at least 28 days before commencement of Installation.
- (6) There shall be separate checklist for TMS, EI, MSDAC, IPS/UPS, Data loggers, Signals, Points machines, Cables, Location Boxes, earthing and Bonding etc. Installation checklist issued by RDSO/OEM, where available shall be followed. The installation check list shall include Structure gauge checks to ensure the installations are carried out to the Schedule of Dimensions requirements;
- (7) The Installation shall be inspected and witnessed by the Engineer/Employer's representative as per the Installation checklists and records maintained. The defects noticed during inspection shall be appended to/recorded on the Inspection checklists. Once the Contractor has rectified the defects, the same shall be verified by the Engineer and recorded. The Installation inspection records and Installation checklists shall form part of Installation test records.
- (8) These tests shall culminate in SAT to verify the correct operation of all apparatus and where appropriate, correct response to the respective control commands or monitored function.
- (9) Installation Tests
 - (c) After installation of the equipment, Visual inspection on un-energized equipment shall be carried out to check the following:
 - (i) Cleanliness;
 - (ii) Workmanship;
 - (iii) Confirmation of items conforming to ratings specified;
 - (iv) Water and dust proofing;
 - (v) Levelling, mounting and positioning;
 - (vi) Joints and connections tightness;
 - (vii) Cables – dressing, bending radii, jointing and finish at terminals;
 - (viii) Clearances and dimensions in conformity with drawings and SOD;
 - (ix) Earthing and bonding;
 - (x) Layout and Equipment profile check.
 - (xi) Protection devices;
 - (d) The Visual inspection shall be followed by (but not limited to) further Installation tests as under:
 - (i) Voltage measurements;
 - (ii) Continuity test as per wiring diagram;

- (iii) Cable Insulation testing;
- (iv) Power cubicle function test;
- (v) Wire continuity tests;
- (vi) Earth value measurements;
- (vii) Wire count tests;
- (viii) Software is correctly installed with the correct version and checksum;
- (ix) Circuit board is of correct version and is correctly installed;
- (x) Strap and Function tests;
- (xi) Through circuit function test of the equipment;
- (xii) Signal Sighting tests;
- (xiii) Functioning of circuit breakers, isolating switches and their interlocks;
- (xiv) Interface tests with other equipment.

7.5 SYSTEM ACCEPTANCE TEST

7.5.1 Once the Installation tests on individual items/equipment/subsystems are complete and they are interconnected and configured to form a complete system, the System Acceptance Test is carried out to ascertain that all the equipment supplied under this Contract satisfy the functional and specified performance requirements in all respects.

7.5.2 System Acceptance Tests shall comprise of comprehensive testing of the completely assembled installation to ensure that every item has been installed and adjusted and that all systems operate in every respect in accordance with the requirements of the specification and are ready for integrated testing and commissioning

7.5.3 The Contractor shall prepare and organize a comprehensive Program of Tests to demonstrate to the Engineer that all systems, sub-systems and apparatus defined under the Contract, when installed, connected and configured as a complete system meet the specified performance requirements in all respects.

7.5.4 Prerequisites for commencement of the System Acceptance Tests (SAT):

- (1) All documentation for the System Safety report have been submitted to the Engineer for review;
- (2) All Installation Tests have been completed and test records submitted to the Engineer for review;
- (3) Facilities for the maintenance of the system are in place; and
- (4) The SAT Plan has been submitted to the Engineer for review at least one hundred and sixteen (116) days before the commencement of the SAT.

7.5.5 Verification and Validation of Application logic

- (1) The FAT tested Application logic shall be loaded in the installed EI and verified to see that it meets the requirement of the Control table.
- (2) Tests shall be carried out on each signalling function to ensure that all the controls specified in the Control tables are present and effective.
- (3) It is permissible for the application logic to be verified by use of simulation

systems. The extent of verification testing by simulation shall be defined in the Test plan.

- (4) Where a control is required to be in the Application logic but is not possible to test, this shall be stated in the test specification, together with any alternative testing to be performed to mitigate any reasonably foreseeable hazard.
- (5) Functions commonly requiring to be tested include, but are not limited to:
 - (a) EI Hot standby tests;
 - (b) Point interlocking;
 - (c) Route interlocking;
 - (d) Sectional and sequential route releasing;
 - (e) Route initiation and setting;
 - (f) Approach locking;
 - (g) Train operated route release;
 - (h) Block controls;
 - (i) Level crossing controls; (deleted)
 - (j) Emergency cancellations;
 - (k) Crank handle interlocking;
 - (l) Aspect sequence.
- (6) Verification shall demonstrate that correct correspondence exists between all commands, controls, status detecting mechanisms and their indications, both within the integrated system and to any external interfaces.
- (7) Validation of Application logic involves testing of the Application logic in accordance with the requirements of the relevant safety case and product application requirements. The validation activities shall be defined in the test specification.

7.6 INTEGRATED TESTING AND COMMISSIONING

- 7.6.1 Integrated Testing on Completion shall include the Work of other contractor(s). The Contractor shall, following satisfactory completion of tests on his works, equipment, sub-systems or system, perform, at the direction of the Engineer, Program of tests to verify and confirm the compatibility and complete performance of his works, equipment, sub-systems or system with the works, equipment, sub-systems or system provided by others.
- 7.6.2 The Contractor shall submit to the Engineer the requirements and procedures in respect of the Contractor's scope of work for Integrated System Tests in conjunction with the other contractors to demonstrate that the complete system provided under the Contract is fully operational and meets the specified performance criteria.
- 7.6.3 Integrated Testing and Commissioning refers to those tests undertaken in order to demonstrate that the various components of the railway systems operate satisfactorily between one another and meet all specified requirements for design, operability, safety, and integration with other works and systems.

- 7.6.4 Integrated Testing and Commissioning shall include the integration of the section New Khurja - New Boraki – IR Dadri (ICD) yard – Dadri area, New Boraki – WDFC with the adjacent sections of EDFC, IR and WDFC, including respective OCC's, without disturbing the safety and revenue operation of the earlier sections.
- 7.6.5 Conducting of these Integrated Tests by the Contractor and the other contractors shall include a period of Trial Run.
- 7.6.6 The Contractor along with others Contractor(s) shall carry out all statutory tests and trials under the supervision of the Engineer, necessary for obtaining sanction of the competent authority, if required, for opening the Railway System.
- 7.6.7 The results of the Integrated Testing and Commissioning shall be documented.
- 7.6.8 If any Signalling equipment/sub system fails to pass Integrated Testing and Commissioning, the Contractor shall carry out at his own cost the necessary adjustment or modification to the equipment/sub system required to satisfy the requirements of Integrated Testing and Commissioning within such time as the Engineer may deem fit.

7.7 TRIAL RUNS

- 7.7.1 On completion of Integrated testing and commissioning to the satisfaction of the Engineer and System acceptance test, the Contractor shall confirm in writing to the Engineer that the works provided by him under the contract is ready for the Trial runs.
- 7.7.2 During the Trial run, the Employer will run the actual trains. The objective is to check that the functions and operations of the various systems are satisfactorily integrated and to allow all technical systems to settle and operating staff to become conversant with the working procedures.
- 7.7.3 The Trial run shall be made use for ensuring the following:
- (1) Signal and indicators Sighting – approach sighting, focus, alignment, relationship with other signals, and interference from other sources of light (e.g. street lamps);
 - (2) Track Vacancy detection system operates correctly, reliably and continuously during presence/absence of a train; and
 - (3) Dynamic interfaces – Integrity of operation and indications across boundaries between different types of track vacancy detection equipment and between different interlocking;
 - (4) Checking for timing issues with level crossings;
 - (5) Confirmation that train describer stepping, and associated systems, works correctly, especially across boundaries;
 - (6) Specific types signalling equipment could require a test train, especially where evidence of the correct operation of train / signalling equipment interfaces is required; and
 - (7) Verify the layout to the Signalling plan, as far as practicable.
- 7.7.4 The Engineer may issue instructions to the Contractor for particular works or actions required of him during this period. In addition, the contractor shall make good all defects and complete all outstanding works within the Trial period so as to permit the commencement of revenue operations.
- 7.7.5 The Contractor's personnel shall be available throughout the period of Trial run.

7.7.6 After the successful Trial Run and after obtaining statutory clearances / approvals from CRS and or other relevant authorities, the Works shall be commissioned with the consent of the Engineer.

7.8 STATUTORY CLEARANCES

The Contractor shall obtain all the mandatory clearances required for commissioning of Signalling work. In such case, the Employer shall extend all the requisite help and assistance to enable inspection, tests, verification of test records and trial run by CRS.

The CRS sanction, if required will be applied for by the Employer. The Contractor will, however be responsible for preparation of all supporting documents required for CRS sanction.

(End of Chapter 7)

CHAPTER 8: DOCUMENTATION

8.1 GENERAL

- 8.1.1 Requirements of Documentation in general are covered in Chapter 5 and 6 of General Specifications Vol.1, Part 2. This chapter mentions particular requirements of Documentation for Signalling System.

8.2 LIST OF DOCUMENTS

The documents to be supplied by the Contractor shall be, but not limited to, the following:

8.2.1 Management Plans

As per Chapter 3, General Specifications Vol. 1 Part 2 Section VI

8.2.2 Preliminary Design Submissions

- (1) Design manual.
- (2) System requirement specification
- (3) Specifications of systems/ subsystems/equipment
- (4) Identification of design codes and standards
- (5) System Simulation Report
- (6) Design Templates for Signal Interlocking Plan, Route Control Table, Detailed Design sheets etc.
- (7) Preliminary System design
- (8) Block diagrams showing information flow from site to station to OCC bringing out clearly the redundancies provided
- (9) Equipment proposal for Station & ALH
- (10) Equipment sizing for Station & ALH
- (11) Equipment layout Plan for Station & ALH
- (12) Preliminary Power Supply diagram for TMS
- (13) Power Supply diagram for Station & Auto location Hut
- (14) Preliminary Power supply load calculation for Junction Station and Auto Location hut
- (15) Preliminary climate management calculations. (Station/Auto location hut)
- (16) Survey Reports
- (17) Earthing, Lightning & Surge protection plan
- (18) Typical Axle counter Plans showing both Main and supervisory sections
- (19) Typical Cable termination details for track side devices such as axle counters, points, signals etc.
- (20) Location Box Foundation drawings
- (21) Signal Foundation drawings

8.2.3 Detailed Design submissions

- (1) Signal Interlocking Plans of Station and Block sections.
- (2) Route Control tables.
- (3) VDU diagram.
- (4) System configuration showing EI connectivity.
- (5) Equipment Layout Plans – OCC, Signal Equipment Room, Power Supply room, Auto Location Hut, Location/Junction Boxes, SM office.
- (6) Cable Core Allocation - Station, Block section.
- (7) Cable Route Plan - Station, Block section.
- (8) Power supply Load Calculation for Station
- (9) Power supply Load Calculation for Auto Location huts
- (10) Circuit Diagrams/Wiring diagrams.
- (11) Application Logic of Station and Block sections.
- (12) Equipment Rack details.
- (13) Cable Termination Rack Diagrams.
- (14) Fuse Details.
- (15) Relay Contact analysis.
- (16) Configuration data, parameters and settings.
- (17) Interconnection details for all equipment in SER.
- (18) Track devices termination details.
- (19) Cable termination details of locations/Junction boxes.
- (20) Station Working Rule Diagrams.
- (21) Detailed Signalling Power supply distribution arrangement at OCC, Station, Auto Location Hut.

8.2.4 System assurance submissions

- (1) System Assurance Plan including
 - (a) System RAM Plan and
 - (b) System Safety Plan
- (2) Safety policy
- (3) Hazard Analysis and Hazard Log
- (4) Design/System Safety Studies and Report
- (5) RAM Analysis and Prediction Report
- (6) FMECA
- (7) RAM Demonstration plan.
- (8) Engineering Safety Validation Report
- (9) Operational Safety case

8.2.5 Operation and Maintenance Manuals

Please refer to Chapter 14, General Specifications Vol. 1 Part 2 Section VI

8.2.6 Documents for CRS Sanction

CRS sanction supporting documents, including Station Working Rules (SWR) etc.

(End of Chapter 8)

CHAPTER 9: TRAINING

9.1 GENERAL

- 9.1.1 Requirements of Training in general are covered in Chapter 13 of General Specifications Vol.1, Part 2. The provisions here cover the particular requirements of Training for the Signalling System.
- 9.1.2 The Training shall be imparted both at the manufacturer's premises as well as at the site. The Training at manufacturer's premises shall include at least 50 trainee man-days, covering all equipment and be held in India and abroad depending on where the manufacturing facility is located. The training at site shall be for a minimum of 80 Instructor man-days.
- 9.1.3 The Contractor shall bear all the training costs except for allowances for Boarding & Lodging and travel expenses of the Employer's trainees.
- 9.1.4 The Contractor shall provide full-time management, co-ordination and supervision of the entire training to ensure continuity of classes and proper distribution of training materials and be responsible for interfacing with the instructors.
- 9.1.5 Throughout the Training, the Engineer shall have free access to all training sessions to monitor the progress of the trainees and the Contractor's training instructors.
- 9.1.6 If required by the Engineer, any one or more of training courses may be repeated during currency of the contract to train additional batches of staff.

9.2 OBJECTIVES OF TRAINING

Objectives of Training are:

- (1) To enable the Employer's maintenance personnel to maintain the commissioned Signalling and Telecommunication systems;
- (2) To enable the Employer's Operating personnel to become competent in operating the various systems/sub-systems at work site; and
- (3) To enable the Employer's Key Instructors to become competent to deliver future courses to other employees of the Employer;

9.3 TRAINING COURSES

- 9.3.1 Each Training Course shall be specific and shall consist of classroom, hands-on and/or field training as necessary to accomplish the Course Objectives specified in the Training Program Plan. The Contractor shall develop detailed training modules based on information in the Operating and Maintenance manuals.
- 9.3.2 The Training courses shall be programmed in phases with the progress of manufacture and installation to ensure that trainees are present during all stages of the manufacture, installation and commissioning of the equipment which is the subject of the training.
- 9.3.3 The Employer's Key Instructors shall attend all types of training courses so that they shall be able to subsequently train the Employer's staff in future in all aspects of operation and maintenance of the System.

9.3.4 Training Courses for Operating Staff

The Training courses for Operating personnel on Signalling and Telecommunication systems/sub-systems shall be developed to provide all necessary knowledge and skills

that enable them to operate the system under normal and emergency situations and recovery from minor or simple faults. In particular, the Training course shall include the following as minimum:

- (1) Overview of the system/sub-system;
- (2) Brief description the operational principles of the system/sub-systems;
- (3) Operational features and functions;
- (4) Familiarisation and use of all man-machine interfaces involved;
- (5) Reading and interpretation of system status and alarm messages or indications;
- (6) Normal operating procedures;
- (7) Operating procedures under emergency situations; and
- (8) Procedures for recovery from minor or simple faults.
- (9) A comprehensive list of Dos and Don'ts shall be prepared and explained to the Operating personnel and also shall be prominently displayed at the stations.

9.3.5 Training Courses for Signalling Maintenance Staff

The Training courses for maintenance staff at site shall, as a minimum, impart the following techniques to maintenance staff of Employer of the appropriate grades:

- (1) Planned maintenance and overhaul of all the railway systems/subsystems supplied, installed or modified under the Contract;
- (2) Fault diagnosis and rectification techniques for the systems/subsystems including equipment supplied, installed or modified under the Contract. These shall be developed from the Contractor's previous experience with similar equipment and also from the fault tree analysis and other analysis carried out as part of the reliability engineering studies undertaken by the Contractor;
- (3) Normal and degraded modes of operation of the S&T systems/subsystems including equipment supplied, installed or modified under the Contract;
- (4) All rules, regulations, practices and procedures necessary for the safe and efficient operation of the S&T systems/subsystems supplied, installed or modified under the Contract; and
- (5) All contingency plans necessary to recover speedily and safely from any mishaps or emergencies that may arise with the S&T systems/subsystems supplied, installed or modified under the Contract.

9.3.6 The Training in Operation and Maintenance shall enable trainees to obtain competence, including obtaining Competency Certificate from the competent authority.

9.3.7 The Training courses for system engineers at manufacturing facilities shall be developed to provide all necessary knowledge and skills to perform system engineering management including system parameter configuration, enhancement, expansion and provision of new circuits.

9.3.8 The Contractor shall determine the content of the system engineering courses, however the courses shall include the following as minimum:

- (1) Overview of the S&T systems/subsystems;
- (2) Brief description of the operation principles of the Subsystems and background theory;

- (3) System/ operational features and functions;
- (4) Description of system components and equipment down to card or module level;
- (5) Test and commissioning procedures;
- (6) Use of test equipment and special tools;
- (7) Reading and interpretation of alarm indications, messages and print-outs;
- (8) Preventive maintenance procedures;
- (9) Fault diagnosis, troubleshooting and corrective maintenance procedures;
- (10) Equipment settings and parameters configuration;
- (11) Use of Equipment manuals, Operation and Maintenance manuals, circuit diagrams and wiring schematics;
- (12) Methods and procedures to provide new circuits, system expansion and enhancement;
- (13) Data, software backup and loading;
- (14) Use of software such as peripheral control and configuration, utility, database structure, generation and modification;
- (15) Periodical Maintenance schedules and impacts;
- (16) Familiarisation and use of all man-machine interfaces involved;
- (17) Normal operating procedures;
- (18) Operating procedures under emergency situations; and
- (19) Procedures for recovery from faults

9.3.9 Training Courses for Signalling Sub Systems

The Contractor shall provide training courses for each of the Signalling sub-systems including but not limited to:

- (1) Electronic Interlocking (EI).
- (2) Power Supply System (Auto changeover, IPS/UPS, Batteries etc.)
- (3) Multi Section Digital Axle Counters (MSDAC) and Single section Digital Axle Counters (SSDAC).
- (4) Train Management System (TMS).
- (5) Point machines.
- (6) Earthing and Surge Protection Systems.
- (7) Electric Lifting Barriers

9.4 TRAINING MATERIAL AND EQUIPMENT

9.4.1 The Contractor shall arrange all training material including but not limited to tables, chairs, white boards, and so on. If available, the Contractor may however, use the training rooms of the Employer.

9.4.2 At the commencement of the training course, the Contractor shall, distribute two sets of Trainer's guides and one set of Training manual for each trainee and two sets of Trainer's guides and three additional sets of Training manual to the Engineer

- 9.4.3 Training course notes shall be compatible and where appropriate, cross-referenced to the Manuals supplied by the Contractor as part of the Operation and Maintenance documentation.
- 9.4.4 The Training course notes and Trainer's guides shall be submitted to the Engineer for review six (06) months prior to the commencement of the first training session of the course. Course notes and Trainer's guides shall be in a standard format as decided by the Engineer and in a form that allows for easy reproduction. At least two months before the commencement of the training course, the Contractor shall submit all the training materials including the trainer's guides, training manual for trainees, training aids and presentation materials to the Engineer for review. The training materials shall be prepared in a form allow easy future reproduction.

(End of Chapter 9)

CHAPTER 10: SPARES, SPECIAL TOOLS AND TEST EQUIPMENT

10.1 GENERAL

- 10.1.1 The requirements covered here shall be read in conjunction with Chapter 14 of GS, Vol 1, Part 2.
- 10.1.2 The Contractor shall provide Spare parts generally in accordance with the principles as given below. All Spare parts for which the Contractor has been authorized to provide through a written instruction by the Engineer shall be provided six weeks before commencement of train operations.

10.2 SUPPLY OF SPARES

10.2.1 The Spare Parts to be supplied by the Contractor shall consist of:

- (1) Commissioning Spares (as hereinafter defined);
- (2) Defects Liability Spares (as hereinafter defined); and
- (3) Contract Spares (as hereinafter defined).

10.2.2 Commissioning Spares

- (1) The Contractor shall keep on the Site throughout the installation, erection and commissioning periods, sufficient stocks of Spare Parts ("Commissioning Spares") to enable immediate replacement of any item in the Permanent Works found to be defective or in any way in non-conformance with the Specification during the installation, erection and commissioning period.
- (2) The Contractor shall submit the list of 'Commissioning Spares', with the types and quantities of Spares the Contractor intends to hold, at least three (3) months before the commencement of the installation activity, to the Engineer for review.
- (3) The Contractor shall ensure availability of 'Commissioning Spares' on or before the commencement of any System Acceptance Tests (SAT).

10.2.3 Defects Liability Spares

- (1) The Contractor shall keep sufficient stocks of Spare Parts in an off-site location in their site office throughout the Defects Notification Period to enable rapid replacement of any item in the Permanent Works found to require replacement as part of the Contractor's obligations during the Defects Liability Period ("Defects Liability Spares").
- (2) The Contractor shall submit the list of 'Defects Liability Spares', with the types and quantities of Spares the Contractor intends to hold, at least six (6) months before the commencement of the DNP, to the Engineer for review.
- (3) The Contractor shall ensure availability of 'Defects Liability Spares' on or before the commencement of the DNP.

10.2.4 When the Contractor submits the list of 'Commissioning Spares' and 'Defects Liability Spares' for Engineer's review, the Contractor shall provide calculation to support the proposed types and quantities taking into account the following:

- (1) The expected failure rate of the parts.

- (2) Population of the parts in the system.
- (3) Criticality of the parts in the system.
- (4) Availability and MTBF figures of the system.
- (5) Spare delivery lead time.
- (6) Workshop repair turnaround time.

10.2.5 The Contractor shall keep and maintain sufficient stock of his own 'Commissioning Spares' and 'Defects Liability Spares'. The Contractor will not be allowed to use the 'Contract Spares' for his Installation & Commissioning and Defects Liability needs.

10.2.6 The Contractor shall include details of the stock of 'Commissioning Spares' and 'Defects liability Spares' it holds, in the Monthly Progress Report. The Stocks shall include status of the Spares in the stores and under workshop repair.

10.2.7 Contract Spares

- (1) The Contractor's supply of 'Contract Spares' shall be for Employer's operation and maintenance need.
- (2) Following 'Contract Spares' shall be supplied:

SN	Item	Unit	Quantity
1	Underground cable	km	5% of the total cable laid subject to a minimum of 1 km of each type.
2	All other Cable & wires, other than Underground cables	m	5% of the total cable/ wire used / laid subject to a minimum of 100 meter of each type.
3	Power supply – cards, modules, equipment complete with interconnecting cables and connectors and all other associated accessories	Nos.	20% of each type installed subject to minimum of one of each.
4	Electronic Interlocking & Object Controllers (if any) – Control Terminal, cards, modules complete with interconnecting cables and connectors and all other associated accessories.	Nos.	20 % of each type installed subject to minimum of one of each.
5	Digital axle counter – cards, modules complete with interconnecting cables and connectors and all other associated accessories.	Nos.	20 % of each type installed. Subject to minimum of one of each.
6	All rail mounted equipment complete with interconnecting cables and connectors and all other associated accessories.	Nos.	30% of each type installed. Subject to minimum of one of each.
7	VRLA batteries	Nos.	15% of each type installed. Subject to minimum of one set.
8	Signals complete including Signal posts, CLS units etc. Signal Lighting Units etc.	Nos.	5% of each type installed. Subject to minimum of one set.

SN	Item	Unit	Quantity
9	LED Signal Lighting Units complete with current regulator, interconnecting cables and connectors and all other associated accessories.	Nos.	20% of each type installed. Subject to minimum of one set.
10	Point machines including ground connections	Nos.	15% of each type installed. Subject to minimum of one set.
11	Train Management system including networking equipment (except Server) and Video Walls at OCC, TMS terminals, FIU along with interconnecting cables and connectors and all other associated accessories.	Nos.	15% of each type installed. Subject to minimum of one set.
12	Service & Diagnostic system including, Data loggers, data concentrators, HMU, CMU, FEP, LAN switch & other networking equipment (except Server) with interconnecting cables and connectors and all other associated accessories.	Nos.	15% of each type installed subject to minimum of one set.
13	MCB, surge protection device, fuses & terminals	Nos.	15% of each type installed. Subject to minimum of one of each.
14	All other interconnecting cables/ connectors not included above	Nos.	10% of each type installed. Subject to minimum of one of each.
15	Other items/equipment/ material.	Nos.	15% of each type installed. Subject to minimum 2 Nos.

- (3) The Contractor shall submit list and quantities of each type of 'Contract Spares' at least 6 months before start of 'Defect Notification Period', based on approved tentative BOQ which shall be adjusted on approval of As-Built BOQ. All spares quantities shall be rounded up to the nearest deliverable unit.
- (4) The List shall include information on make, model, serial number, rating, description, part number, drawing number, shelf life etc. of each item of 'Contract Spares'. The Contractor shall also identify the lead times for all the Spare parts. Parts with long lead times shall be specially identified in the Spares list. In the event that any of the spares identified have a particular shelf life or storage requirement, this shall be made known to the Engineer with the submission of the Spares list, including the necessary action for disposal or storage.
- (5) The Spare Parts shall be manufactured at the same time as the Permanent Works. All Spare Parts shall be works tested and inspected in accordance with the relevant quality system, suitably packed and labelled and delivered in accordance with GS, Vol. 1, Part 2. Test certificates for each piece or set of equipment shall be submitted to the Engineer.
- (6) Before the Spare Parts are delivered, the Contractor shall submit to the Engineer a shipment advice notifying details of shipment such as date of dispatch, vessel name, etc. as well as a packing list indicating the contract number, order number, the lot size, quantity and weight. The Spare Parts shall be consigned and

delivered in accordance with the Engineer's instructions.

- (7) The Contractor shall complete supply of the 'Contract Spares' on or before start of Defects Notification Period.
- (8) The Contractor shall indicate the sources of supply of all 'Spares' and shall guarantee their availability during the design life of the project.
- (9) Spare Parts shall be fully interchangeable with their corresponding part. All Spare Parts shall be configured to the latest revision during the Defects Notification Period.

10.3 SPECIAL TOOLS AND TEST & MEASURING EQUIPMENT

- (1) Following Tools & Test equipment shall be supplied:

SN	Item	Unit	Quantity
1	General purpose Signalling tool kit consisting of screw drivers of various sizes; flat pliers, nose pliers, cutting pliers, etc. of various sizes; 500 gm. hammer; cable knife, flat chisel of various sizes; brass brush; nylon brush; steel measuring tape,; adjustable screw wrench of various sizes; soldering iron 220V, 60 W; solder wire; tin cutter; flat spanner/ box spanner/ ring/ flat spanner of various sizes; continuity buzzer; AC/DC analog multimeter 2 nos. of Philips or similar make; AC/DC digital multimeter Fluke or similar make; Megger one each for 100 V & 500V. All the tools shall be from reputed manufacturers and shall be supplied in a suitable carrying case.	Nos.	5
2	Megger 500/ 1000 V AC 0 to 200 M ohms with earth tester, electronic push button type of Philips or any other reputed make	Nos.	5
3	Portable digital auto range multimeter, Philips/ Fluke or similar make capable to measure from 0.1 mV / 0.01 mA AC/DC up to 10 Amp. AC/DC, 600 V AC/DC and resistance from 0.1 Ohms to 40 M Ohms complete.	Nos.	5
4	Supply of heavy duty electric drill machine of size 31 mm 230V AC with hammering action complete capable of working on metal/ wood/ concrete complete with chuck and drill bits of various sizes for all three surfaces in a suitable carrying case from reputed manufacturers.	Nos.	5
5	Supply of electric drill machine of size 6 mm and other description as per 4 above.	Nos.	2
6	Digital earth tester, 4 terminal, range 0-10/ 100 ohms with rechargeable battery complete with	Nos.	2

SN	Item	Unit	Quantity
	other required accessories in a suitable carrying case.		
7	Laptop based mobile maintenance terminal	Nos.	5
8	Complete tool kit for maintenance of EI as per the recommendations of the manufacturer in a suitable carrying case.	Nos.	1 at each EI
9	Complete tool kit for maintenance of DAC as per the recommendations of the manufacturer in a suitable carrying case.	Nos.	1 for each Evaluator of MSDAC.
10	Complete tool kit for maintenance of IPS as per the recommendations of the manufacturer in a suitable carrying case.	Nos.	1 for each IPS.
11	Special tools, test equipment including access ladders and protective gear for maintenance of gantry mounted signals if installed.	Set	1 set
12	Computer based test set up with required software for automatic testing like 'Functional Testing' etc.	Nos.	Min. 1 Nos.

- (2) These Special Tools & Test equipment are for use by the Employer during normal operation & maintenance after taking over of the installations. None of the Special Tools and Test equipment provided for the Employer shall be used by the Contractor on site prior to delivery. The Contractor shall make his own arrangement of Special Tools and Test equipment for use during Installation and Defects Notification Period.
- (3) The Contractor shall submit list and quantities of each type of 'Specials Tools and test Equipment' at least 6 months before start of 'Defect Notification Period', based on approved tentative BOQ which shall be adjusted on approval of As-Built BOQ.
- (4) The List shall include information on make, model, serial number, rating, description, part number, drawing number, details of calibration etc. of each item of 'Special Tools and Test equipment'.
- (5) All Special Tools and Test Equipment shall be accompanied with drawings, schematics, assembly and connection drawings, circuit diagrams/descriptions, calibration instructions and Operation and Maintenance Manuals to enable them to be used by suitably skilled (but not necessarily specially trained) personnel in a non-hazardous manner and to achieve the desired result in terms of accuracy and quality.
- (6) The Contractor shall provide the means and instructions which describe the parameters of each item of Special Tools and Test Equipment that are critical to their proper methods of use and which enable the Employer's staff using the Special Tools and Test Equipment to achieve the proper performance and operation. Such means and instructions shall include, but not be limited to, any routine checking or re-calibration needs for the Special Tool and Test Equipment

itself.

- (7) The Special Tools and Test Equipment (together with the relevant calibration certificates) required to carry out all the functions described in the Operation and Maintenance Manual shall be suitably packed and identified in accordance with Part 2, Section VI, Volume 1, General Specifications, consigned and delivered in accordance with the Engineer instructions. The extent of supply shall include protective carrying cases as may be appropriate for the storage and use of each item. The supply of all 'Special Tools and Test equipment' shall be completed by the start of DNP.
- (8) The Contractor shall indicate the sources of supply of all 'Special Tools and Test equipment' and shall guarantee their availability during the design life of the project.

10.3.1 The Contractor shall set up an off-line Testing platform at a suitable place provided by the Employer. The Test platform shall consist of all sub systems of Signalling in minimum configuration, inter connected together. The Testing platform shall have the capability to test signalling equipment/components/sub systems of EI, MSDAC, TMS, IPS/UPS etc. The testing platform shall be commissioned before revenue operations.

10.3.2 At any stage if the Employer feels that the 'Contract Spares' and 'Special Tools and Test equipment' being procured are less, then it reserves the right to order additional quantities before expiry of Defects Notification Period, as a Variation to the Contract Price at an agreed Price. Computer based inventory management plan for 'Spares' and 'Special Tools & Test equipment' shall be established by the Contractor for use of the Employer.

(End of Chapter 10)

CHAPTER 11: INTERFACE REQUIREMENTS

11.1 GENERAL

- 11.1.1 The Contractor shall coordinate with other contractors working in the section viz. CST Contractor(s) for Buildings & Structures and Track and any other contractor engaged by Employer for Dadri-Khurja section. The Contractor shall also coordinate with other contractors working in the adjoining sections of EDFC & WDFC as well as with Indian Railways officials, government departments etc., as required, for timely completion of the Work.
- 11.1.2 The Contractor shall ensure that the issues/information pertaining to him that have been included in the IMP and the ICD, are timely exchanged/resolved and have no bearing on the Works Programme.
- 11.1.3 It would be the responsibility of the Contractor to settle all disagreements with the Other Contractor(s). If such disagreement cannot be resolved by the Contractor, despite having made all reasonable efforts, then the decision of the Engineer shall be final and binding on the Contractor.

11.2 INTERFACE WITH CST CONTRACTOR (CP 302)

- 11.2.1 For successful execution of the work, interaction will be required between the Contractor & CST Contractor (CP 302) on the following issues. It will be incumbent on the contractor to interact with the CST contractor on these issues.
- (1) Regarding track alignment, cant, versine, track geometry, rail levels, gradient, curve details, track center along with transition curve details.
 - (2) Right of Way and Access free of encumbrances to sites on Main Line and at Stations.
 - (3) HDPE/GI Pipes below tracks of requisite size for track-crossing of Signalling Cables.
 - (4) The Signalling requirement of Track, Track Alignment, Points & Crossings, Service Buildings, Yard Layouts etc., including the access dates and various milestone dates so as to co-ordinate the Signalling Works under this Contract.
 - (5) All the information regarding Signalling design and execution, which may be reasonably needed by CST Contractor(s) to design and execute their works under their Contract.
 - (6) Contractor's Interface with CST Contractor shall be done for the following, but shall not be limited to the following:

S. No.	Interface Subject	Contractor	CST Contractor (CP 302)	Document
1	Design and Construction of Signalling Equipment Room (SER) and Signalling Power Supply Equipment Room(s) as part of Station Building at Stations.	<ol style="list-style-type: none"> 1. Shall review the size of Signalling Equipment Room (SER) and Signalling Power Supply Equipment Room(s) and advise change in size, as required to the CST contractor. 2. Shall provide the requirement of ventilation and flooring. 3. Shall provide the requirement of cable ducts in the floor & cable-entry locations in the rooms. 4. Shall advise the size and location of cable pits being constructed at cable inlet points. 	<ol style="list-style-type: none"> 1. Shall design and construct the rooms. 	
2	Design and Construction of additional Signalling structures in Station area	Shall decide the size & location and construct any additional Signaling structures in Station area in coordination with the CST contractor.	Shall provide consent for location for construction of any additional Signalling structures in Station area	Approved Site Plans for the SER/Power Supply Rooms.
3	Signalling Equipment Room (SER) and Signalling Power Supply Equipment Room(s) in Block Sections and at Interfacing IR Stations	Shall decide the space (Site Plans & Construct SER and Power Supply Equipment Rooms in coordination with the CST Contractor)	Shall provide consent for space for construction of SER and Power Supply Equipment rooms	Approved Site Plans for the SER/ Power Supply Rooms.
4	Trenching for trackside cable laying.	Shall decide the route for cable trenching and carry out trenching work in coordination with the CST contractor.	<ol style="list-style-type: none"> 1. Shall provide consent for space for trenches as required by Contractor for their cable laying. 2. Shall provide drawings for any underground services provided by him. 	Cable Route Plan

5	Track Alignment and Yard Plans	Shall advise modifications to yard plans, if required, from Signalling point of view duly approved by Engineer.	Shall modify the yard plans as per Signalling requirement, and provide the same, duly approved by the Engineer.	CST Contractor shall incorporate modifications in yard plans and shall process for their validation.
6	Cable passage requirement on bridges/culverts	Shall draw out sketches and provide to CST Contractor for requirement of cable laying on bridges/Culverts	Shall provide consent for space for laying GI pipes/ troughs on bridges, and shall provide Cable Ducts on Culverts.	System Contractor shall provide drawings showing requirements for cable running on bridges/culverts.
7	Point Machines installation	Shall coordinate with CST contractor and install point machine fittings as required for point operation.	Shall provide Points as required by Signalling for point machine installation and commissioning.	Indian Railways Signal Engineering Manual
8	Testing of Points	Shall jointly test Points with CST Contractor during integrated testing & commissioning and rectify all Signalling defects as required during testing.	Shall jointly test the Points with S&T Contractor and rectify any track-related defects identified during testing	
9	Electrical Parameters of track/ turn-out related assemblies	Shall furnish the requirements of electrical parameters of track assembly for track circuit (if provided)	Shall provide the track parameters including, but not limited to, ballast resistance, sleeper insulation etc., as required by signalling works.	
10	Glued joints for Track Circuits (if provided)	Shall furnish requirement and locations of Glued Joints/Insulated Joints, if any.	Shall provide Glued Joints /Insulated Joints at locations specified by the Contractor, if any.	
11	Track/Road/Platform crossing of cables.	Shall provide Track/Road/Platform crossing at locations required for S&T work, in coordination with the CST contractor.	<ol style="list-style-type: none"> 1. Shall provide consent for space for Track/Road/Platform crossings of S&T Cables, as per their requirement. 2. Shall advise location of RCC pipes as laid by them for S&T cable crossings. 	
12	Marking centre-line of track and locations of stock joints.	Line-side installations shall be carried out in coordination with the CST Contractor.	Shall provide the centre-line and Stock-Joint locations to the Contractor.	

11.3 INTERFACE WITH SYSTEM CONTRACTOR (CP 104)

The Contractor shall interface with the System Contractor of EDFC 1 (CP 104) for seamless integration of S&T system being provided under the contract, on the following issues, but not limited to:

S. No.	Interface Subject	Contractor	System Contractor (CP 104)	Document
1	Train Management System	Shall identify and collect all information on TMS of EDFC 1, as required to commission TMS of CP 105, as per provisions of the contract.	Shall provide all information of TMS system of EDFC 1, as required by the Contractor.	Design & Documentation of TMS of EDFC 1
2	Service & Diagnostic System	Shall identify and collect all information on S&D system of EDFC 1, as required to commission S&D system of CP 105, as per provisions of the contract.	Shall provide all information of S&D system of EDFC 1, as required by the Contractor.	Design & Documentation of S&D system of EDFC 1
3	Power supply at OCC	Shall collect all information about the Power supply system – LT Panel, UPS etc. provided in EDFC 1, as required for augmentation of same to meet the requirements of CP 105.	1. Shall provide all information about the Power supply system – LT Panel, UPS etc. provided at OCC.	Design & Documentation of Power supply system of EDFC 1
4	Modifications at Khurja Station	Shall identify and collect the S&T design documents of Khurja station as required to commission Khurja – New Boraki automatic section.	Shall provide the S&T designs of Khurja Station, as required by the Contractor.	Design & Documentation of Khurja station of EDFC 1

11.4 INTERFACE WITH INDIAN RAILWAYS

The Contractor shall liaison with designated authorities in Indian Railway to design Signalling and Telecom Arrangement for/at boundaries with Indian Railways. The design so finalised shall be submitted to Engineer for review. The contractor shall execute the so reviewed Signalling & Telecommunication arrangement for/at boundaries with Indian Railways.

11.5 INTERFACE WITH WDFC CONTRACTOR (CTP 14)

The Contractor shall interface with the CTP 14 contractor of WDFC, for seamless integration of Signalling and Telecommunication system provided on the twin single lines connection to WDFC.

(End of Chapter 11)

Appendix 1

Uninterruptible Power Supply System - Technical Specifications

1. GENERAL

- (1) The UPS and battery backup equipment shall conform to latest versions of following international standards covering Safety, construction, electromagnetic interference and operation. In case of any conflict, more stringent requirement shall apply

RFI Suppression	EN 55022A or VDE 0878
Boost cum float charger	IEC 60146, DIN-41772
General & Safety requirement	IEC 62040-1-1
EMC requirements	EN 50091-2, EN 50091-3
Protection class	IEC- 60950
Compliance to Quality Standards	ISO 9001-2008 & ISO 14001
Automatic Transfer Switches	IEC 60947-6-1, UL 1008 Listed
VRLA Batteries	IRS: S 93-96, IEEE485 Sizing
Protection against Lightning	IEC 62305
Railway applications – Surge arresters and low-voltage limiters for specific	IEC 61992
Transient Voltage Surge Suppressors	IEEE C62.41 Sizing, UL1449-3 Listed
Overall UPS System	IEC 62040-3, IEC60146

- (2) The design shall take into consideration the voltage drop between the power supply source and the Signal & Telecommunication systems load (as the case may be), individually at each location (Auto location/ station etc.).
- (3) Provision of suitable earth leakage detection and alarms shall be made individually at each location (Auto Location/station etc.).
- (4) Conceptual design of the UPS and the battery backup for Signalling and Telecommunication Systems is as per attached Single Line Diagrams. (Annexure I & II of Appendix 1). The contractor shall submit detailed design separately for Stations, Auto Locations and OCC for review by the Engineer.
- (5) OCC UPS System shall have Load Bus Synchronization (LBS) Panel to ensure same parameters like frequency and voltage etc. in both buses. Supply to single source critical load shall be through free standing independent external static switch which will be connected from both Buses for its input sources as shown in Single Line Diagram (Annexure II of Appendix 1). External Static Switch shall be as per specifications mentioned in Para no -12 of this document.

2. SYSTEM OPERATION

The UPS system shall be designed to operate in the following modes:

(1) Normal

The incoming power supply reaching the UPS Modules through an Input Isolation Transformer shall be rectified into regulated DC voltage for charging the battery and powering the inverter to supply the loads.

(2) Emergency

Upon failure or fluctuation of the incoming supply beyond acceptable limits an Automatic Transfer Switch shall detect and transfer/switch to the other incoming source so that supply to the UPSs and Stabilizer is maintained. In case of absence / failure or fluctuation of both the Input Supply sources, the battery banks of the UPS shall, without interruption, supply DC power to the UPS inverters to supply the loads. When incoming mains supply is restored or returned to the specified limits, the rectifier shall resume normal operation automatically without disturbance to the loads. During this transition of the DC Supply to Inverter, from Rectifier to Battery and vice versa, there should not be any switching delay since the Battery bank will be directly connected to the Rectifier-Inverter DC Bus and Floating on the DC Bus. Inverter shall not be connected to its input DC Bus through any switching devices or reverse blocking diodes

(3) Automatic Transfer Switch shall be a self-powered equipment having complete overlapping neutral, in-phase monitor and operated by a single solenoid, with microprocessor based controller suitable for 230 V / 415V, 50 Hz supply. The ATS shall be conforming to UL-1008 and shall be 3rd party tested with a circuit breaker back up for withstand and close on rating (WCR). The ATS shall be tested for AC-33iA/AC-33A utilization category and shall have inbuilt voltage, frequency and single phasing protection.

(4) Parallel Redundant Operation

Normally, both the 100% rated Inverters will be supplying to the Load sharing it on 50:50 basis. In the event of internal failure/tripping of any one Inverter, there shall be no transfer of load, rather the faulty Inverter shall isolate itself giving adequate alarm indication and the healthy Inverter, which was already sharing 50% of the load, shall continue to work unaffected, taking-up the full 100% load.

(5) Automatic in-built Static Bypass

In the event of the inverter output fault or fault leading to tripping of both the 100% rated Inverters, the in-built Static Switches of Inverter Output and Static Bypass Line shall automatically transfer the loads to the stabilized bypass without any power discontinuity / interruption provided the frequency of the mains input source is within the acceptable band (it is assumed that the bypass source being stabilized, its voltage will always be within the tolerance of the loads). When the inverter output recovers to a suitable level, the switch shall automatically restore the load from the stabilized bypass source to the inverter output.

(6) In-Built Manual Bypass

Each UPS Module will contain 100% rated manual bypass path to allow a no-interruption (i.e., make-before-break) transfer of the loads to the stabilized bypass source for safely carrying out simultaneous online checks/maintenance of the two

UPS Modules. Adequate interlock shall be provided to prevent operation of the manual bypass switch when both the Inverters are healthy and supplying to the loads.

(7) External Super-Bypass

A manual external Super-bypass system shall be provided to allow the UPS modules to be completely isolated for maintenance/repair requiring de-energization of UPS Output terminals or physical relocation/movement of UPS's. Warning labels and adequate interlocks shall be provided to prevent the bypass supply being connected to UPS output terminals while the UPS is healthy and running.

3. EQUIPMENT DESIGN OF UPS

- (1) The audible noise level at 1.5 m radii of the panel, over a load range 10% to 100% full load shall not exceed 56 dBA for UPS Systems rated 30 KVA or below, 65 dB A for UPS Systems between 30-60 KVA and 70dBA for UPS Systems rated between 60-120 KVA.
- (2) The UPS system provided by the Contractor shall be sized to power its full connected load of the Signal & Telecommunication systems working in parallel redundant configuration with at least 20% spare capacity. The back-up shall be for a total period of four hours (2 hours for each UPS Module at full load).
- (3) Each Parallel redundant UPS System shall include adequately rated Automatic Transfer Switch and Input Isolation Transformer, 2x100% rated Rectifier-cum-charger, 2x50% rated battery banks, 2x100% rated IGBT PWM inverters, 2x100% rated output isolation transformers, 1x100% rated Servo Controlled Voltage Stabilizer, 2x100% rated Static Bypass Lines (i.e. 4x100% rated Static Switches), 2x100% rated Manual Bypass lines Switches, 1x100% rated Super-Bypass Line and all associated control circuitry to make the system complete. Failure of any single component shall not cause failure of the total UPS.
- (4) The UPS shall be self-contained floor mounted, bottom entry, metal-clad type with front access. UPS shall be supported on a base frame of at least 150mm height.
- (5) Power supply for the Signal & Telecommunication systems shall have the UPS back-up. The UPS system shall be designed with 100% parallel redundancy with four hour battery backup (each UPS Module should have separate individual battery bank rated 50% i.e., to deliver backup to full load for 2 hours). The two separate 50% Battery Banks will normally work as independent battery banks connected to their respective UPS Modules and shall have provision of their interconnection / paralleling in order to achieve full 100% capacity (i.e. 4 hour backup) in case of simultaneous failures of any one Inverter and all the Input AC Supplies.
- (6) The UPS shall be designed such that failure of or restoration of the 230V AC 1 phase / 415 V AC 3 phase input supply sources shall not have any change or effect and the UPS Inverters will continue to supply to the loads without interruption. Galvanic Isolations both at the Input as well as at the inverter Outputs shall ensure that at no point of time any part of the input supply is electrically connected to the UPS Output bus. Upon restoration of the Input Supply, the UPSs and Stabilizer shall be transferred to it only after a delay and verification that there are no spikes and that the voltage has stabilized.

- (7) Two independent redundant 1-Phase / 3-phase primary power supply will be made available by 'Other Contractor' on the LT Panel provided by him in the OCC. The Contractor shall coordinate with the 'Other Contractor' and carry out all works required to draw the primary power supply from the LT Panel to the UPS.
- (8) **Ripple content in intermediate DC**
- With Battery : < 1%
 - Without Battery : < 2%

4. PARAMETERS APPLICABLE TO UPS

(1) System Input Characteristics

The primary power for the rectifier shall be provided from the switchboards with the following characteristics :

Voltage	415 V, +10%, -20% (for 3-Phase Input Systems) 230 V, +10%, -20% (for 1-Phase Input Systems)
Frequency	50 Hz, +/- 1%
Power Factor	Not less than 0.8 lagging when the system is operating at full load and nominal voltage.

(2) System Output Characteristics

(a) UPS ratings shall be subject to approval by the Engineer based on Load sizing calculations submitted by contractor during detailed engineering.

(b) Output Voltage Requirements

Voltage	400V, 3-Phase, four wires (for 3-Phase UPS Systems). 230V, 1-phase, two wires (for 1-Phase UPS Systems).
Frequency	50 Hz nominal, +/-1% regulation (free running)
Voltage regulation	Static: Better than +/- 1 % Dynamic: Better than +/- 5% (0-100-0% Load Step)
Distortion factor	For linear load: < +/- 1%, For 100% nonlinear load having Crest Factor of 3:1): < +/- 5%.
Crest factor (sustainable by UPS without de-rating)	3:1

(c) Output Voltage Stability

The steady state output voltage shall not deviate by more than +/- 1% from no-load to full-load. The allowable transient output voltage variation is +/-5% and the system output voltage shall return to +/- 1% within 20ms.

(d) Output Frequency Regulation, Stability and Slew Rate

The UPS shall be capable of providing the nominal output frequency within 50 Hz +/- 1% when the UPS inverter is not synchronized to the incoming

mains. When the UPS Inverters are synchronized to Main Frequency, the frequency variation range will be limited to the synchronizing window of 50 Hz +/- 2 Hz. UPS should have facility to set the synchronizing window between +/-1 Hz, +/- 2 Hz, +/-3Hz. The rate of tracking with Mains Frequency (Slew Rate) shall be 1 Hz per sec.

(3) System Overload

Overload capacity (better than) : 150% >60 seconds
: 125% >10 minutes
: 110% >60 minutes

The short circuit current limit shall be set at 155% of the rated output current.

(4) Output Voltage Harmonic content

The total harmonic distortion (THD) of Inverter Output Voltage waveform as generated by the UPS Modules shall be less than 1% for Linear Loads and less than 5% for 100% non-Linear Loads having crest factor of 3:1. Harmonic Distortion for any single harmonic shall be maximum 3%.

(5) Efficiency (AC-AC)

The UPS System including the Isolation Transformers shall have an AC-AC efficiency of 85% minimum at full load. The AC-DC Efficiency of each Rectifier-Cum-Charger / Inverter at full Load and while catering full Charging current to Battery, shall be 98%.

(6) Electromagnetic Interference

Filters shall form an integral part of the UPS to prevent any form of electrical noise or radio frequency interference being generated that may affect the critical load.

(7) Current Limiting

The rectifier/charger shall have input current limiting at 115% so as to disallow any current other than the maximum requirement due to Load Current through Inverter/s and Battery Charging Currents.

(8) Input Power Walk-In

When the mains are restored following an outage, the power and current drawn by UPS modules shall be initially minimum and slowly shall rise to required level in 10-15 sec. to drive the critical load and the additional pre-set power to recharge the batteries as described above.

5. BATTERY BANKS & SIZING

- (1) The battery bank shall consist of two nos. of 50% rated banks of high quality heavy duty maintenance free valve regulated lead-acid (VRLA) 2V Cells having 20 Year designed Float Life, each bank connected to its individual UPS Module, capable of maintaining supply to its inverter at full load for not less than 2 Hours in the event of failure of mains supply or rectifier.
- (2) The two Battery Banks will be normally, separately connected with their respective UPS Modules and give 4 hour backup during normal operation of the two Inverters in Parallel Redundant configuration where each Inverter is loaded 50%. Further, there will be provision of Interconnection/Paralleling between the two Battery

Banks to achieve 100% rating (4 hour backup) in the event of Input Supply failure during single UPS Module operation (other Module Inverter faulty or not in circuit).

- (3) It shall be possible to Isolate individual battery bank and work on it and still have 50% (2 Hours) Backup Power availability from the UPS System to the Loads.
- (4) The battery racks shall have anti acid painting and adequate insulations. The battery racks shall be properly insulated and earthed.
- (5) The battery shall be adequately designed to reduce all possible voltage drop between cells and battery plates and battery plates to conductors bars.
- (6) The life of the battery bank shall not be less than 7 years. The Contractor shall submit documents to verify the life of batteries.
- (7) Separate, externally wall-mounted independent, adequately rated battery circuit breakers for protection shall be provided between the battery bank and the individual UPS modules thereby, isolating the battery bank from the rest of system. The Battery Circuit Breakers (2 Nos. in each set of 2x100% rated UPS) shall have thermal, magnetic as well as under voltage remote tripping mechanism so that they can be remotely tripped from the UPS front panel.
- (8) The battery shall be sized for float voltage of 2.25 Volts per Cell and nominal voltage of 2 Volts per cell suitable for the satisfactory operation of the system and total autonomy of 4 hours. The Contractor shall submit detailed battery capacity calculations to the Engineer for review and approval as per the following minimum requirements:-
 - (a) Full KW rating of Inverter Output at 0.8 lagging P.F.
 - (b) Inverter Efficiency at 50% Load (maximum value to be considered for Battery Sizing shall not exceed 90% for 6 KVA, 93% for 30 KVA , 93.5% for 60 KVA and 94% for 120 KVA UPS's)
 - (c) Minimum End Cell voltage of 1.75 VPC
- (9) Four no. of 2V Cells as per manufacturer and a Spare Cell Charger for charging up to 6 cells at 10% of Battery AH Capacity shall be supplied as Spares with the main supply.

6. RECTIFIER-CUM-CHARGER & SIZING

- (1) The power rectifiers shall be 1-Phase / 3 Phase, Full-wave, Fully-controlled, SCR Bridge Type/IGBT. A separate adjustable DC current limit circuit shall be provided for battery charging current. Subsequent to a discharge cycle when battery is connected to rectifier, the battery current shall be monitored, controlled and limited to set value automatically irrespective of value of inverter input current.
- (2) Rectifier shall be designed to ensure that the total harmonic distortion in the input current to rectifiers as seen by the supply source Bus, is in line with the IEEE std. 519-1992 recommendations.
- (3) The Rectifiers shall be sized based on the maximum inverter load and the nominal rated capacity of the battery. The DC load imposed by inverters shall be considered under the worst case where only one rectifier is feeding both inverters.
- (4) The rectifiers shall be designed to completely charge their individual battery to 90% capacity within maximum 10 hours after complete discharge. Facilities shall

be provided to initiate battery boost charge operation by manual and automatic means as and when the Battery may require.

- (5) The DC regulator shall sense the battery charging current and shall adjust the DC bus voltage to ensure constant current charging.
- (6) Rectifier-cum-Charger should have temperature compensated dynamic Charging wherein, sensing higher ambient around the battery banks, the charging voltage should get automatically regulated at the rate of minus 2 - 3 milli-volt per Deg. C above the desired 27 Degree C. For this, vendor should supply temperature sensors to be fixed at the Battery Bank.
- (7) UPS System should have Online Battery Testing feature from UPS front Panel.
- (8) In line with DIN 41772 I-U Characteristics the Rectifier-Cum-Charger should automatically shift from Float to Boost Mode and vice-versa based on current demand sensing and have an over-riding Boost charge timer settable in 1-15 Hour range.
- (9) Each Rectifier should have adequate rating to simultaneously cater full Battery Charging current and Inverter Current at full load considering that One Rectifier may have to cater charging current to both the 50% rated Battery Banks plus Inverter on full Load. The contractor shall submit detailed rectifier sizing calculations for review of the Engineer as per the following minimum conditions :-
 - (a) Total Rectifier Current = Inverter Input DC Current at full load + 2x10% of Battery AH Duty.
 - (b) Total Rectifier Power Rating (in W) = Rectifier Float level (at 2.25VPC) x Total rectifier current

7. STATIC BYPASS TRANSFER SWITCH

- (1) A static bypass transfer switch Module shall be provided as an integral part of the UPS. This will consist of two sets of 100% rated Static Switches – one for Inverter Output and the other for Static Bypass Line. The control unit shall contain an automatic transfer circuit that senses the status of the inverter logic signals and alarm conditions to provide an uninterrupted transfer of the load to the stabilized bypass source without exceeding the transient limits specified herein when a malfunction occurs in both the UPS Inverters or an external overload condition occurs.
- (2) The static bypass transfer switch shall be a fully Solid State static switch having anti-parallel SCR's that has a maximum transfer time of less than 4 millisecond in Synchronised condition and less than 20 millisecond in Unsynchronised condition. The static switch shall be capable of supplying 125% rated current for 10 minutes, 150% for 60 seconds and 1000 % for one cycle.
- (3) A transfer of load to the bypass supply shall take place in any of the following abnormal conditions:
 - (a) Inverter overload capability exceeded.
 - (b) Inverter output voltage exceeds the overvoltage trip level of 110% or under voltage trip level of 90%.
 - (c) D.C. over voltage.
 - (d) D.C. under voltage.

- (e) UPS fault and
 - (f) UPS over temperature.
- (4) Whenever the load is on the static bypass line, the control panel shall provide an indication of this status. The audible alarm shall sound appropriately. If the transfer was due to a momentary overload and was automatically restored to the UPS module after the overload was removed, the alarm and indicator shall automatically reset.
- (5) The Voltage stability of the Stabilized Bypass source (Servo Controlled Voltage Stabilizer) providing supply to the Static Bypass, Manual Bypass, and Super-Bypass lines should not exceed 230V / 415 Vac +/- 2% in steady state conditions.

8. ENCLOSURES

Following requirements for enclosures shall be met:

- (1) Minimum degree of protection as per EN 60529:
 - IP31: for Stations & OCC
 - IP42: for Auto Location Huts.
- (2) Material and construction: Welded mild steel. Assemble to prevent distortion when the complete enclosure is lifted or transported.
- (3) Finish as provided by OEM.
- (4) Lockable access doors.
- (5) Cable entry with removable gland plates: For bottom entry cables.
- (6) Forced ventilation fans: Required.
- (7) Internal and External interlocking, padlocking, earthing, insulation, screening of enclosures.
- (8) Protection against natural corrosion and galvanic corrosion of dissimilar metals.

9. UPS MONITOR, CONTROL AND INFORMATION SYSTEM

- (1) The UPS system shall be equipped with a status panel to provide monitoring and control of the complete system. Basically, the system shall be able to display the following Alarms and Alerts on the System Front Panel LCD Screen upon their occurrence. If more than one Alarm occurs, they will be displayed in the Screen in continuous cyclic order:
- (a) Output overvoltage
 - (b) Output switch open
 - (c) Rectifier switch open
 - (d) Battery C.B. open
 - (e) Manual bypass closed
 - (f) Bypass: absent
 - (g) Bypass: overvoltage
 - (h) Bypass: under voltage

- (i) Bypass: frequency error
- (j) Bypass: phase rotation error
- (k) Bypass: off
- (l) Load on bypass
- (m) Rectifier: off
- (n) Rectifier: blocked
- (o) Rectifier failure
- (p) Inverter: off
- (q) Inverter: blocked
- (r) Inverter: over temperature
- (s) Inverter: unsynchronized
- (t) Inverter: overvoltage
- (u) Inverter: under voltage
- (v) Output: under voltage
- (w) Battery: under test
- (x) Battery: test failed
- (y) Battery: on load
- (z) Battery: end discharge
- (aa) Battery: boost time expired
- (bb) DC bus: fast overvoltage
- (cc) DC bus: under voltage
- (dd) Overload shutdown
- (ee) Over temperature shutdown
- (ff) Emergency stop
- (gg) Overload
- (hh) Battery earth fault
- (ii) Inverter: failure
- (jj) Inverter: parallel error
- (kk) Over-temperature failure.

(2) System Metering

A single or multiple LCD Panel Metering shall be provided with the capability of monitoring of the following system parameters using a selector switch:

- (a) Output voltage (line-line)
- (b) Output voltage (line-neutral)
- (c) Output current (line)
- (d) Output real power (line)

- (e) Bypass frequency
- (f) Inverter frequency
- (g) Bypass voltage (line-line)
- (h) Battery voltage
- (i) Battery current
- (j) Output apparent power (line)
- (k) Temperature (battery room) - optional
- (l) % line load
- (m) % battery charge.

(3) System Controls

The following minimum user controls shall be provided on Front panel of each UPS Module:

- (a) Alarm reset push-button.
- (b) Inverter ON/OFF or Transfer to Static Bypass membrane switch.
- (c) Emergency shutdown button with protective cover.

(4) System Mimic Diagram

A system mimic diagram using light emitting diodes (LEDs) shall be provided on the equipment as part of the system status panel. The mimic shall depict a complete single line diagram of the UPS and the following functions shall be lit with LED indicators.

- (a) A.C. input power on;
- (b) UPS on battery;
- (c) Inverter ON;
- (d) Static Bypass ON and healthy;
- (e) Load supplied from Inverter and
- (f) Load supplied from Static Bypass UPS.

(5) Potential Free Contacts

Normally open and/or normally closed dry contacts shall be provided for the following minimal conditions :

- (a) Low Battery (pre alarm)
- (b) Load on Inverter
- (c) Load on Bypass
- (d) Load on Manual Bypass
- (e) Bypass failure.

(6) Local Monitoring of UPS

RS485 / Modbus connection should be available from each UPS for local monitoring. The contractor shall submit detailed list of Alarms/Parameters to be locally monitored for review and approval by the engineer.

(7) Comprehensive Remote Monitoring

- (a) UPS System (i.e. individual UPS Modules and ATS) should be connectible to the TCP/IP based LAN Network through 3 Nos. dedicated LAN Ports in each UPS room and 1 No. dedicated LAN Port in the OCC. The detailed status/alarms should be available in the OCC and other terminals as per details given in TMS Technical Specification. Further, all necessary Software shall be provided and installed so as to see comprehensive data from all the Stations, Interlocking structures, OCC etc.
- (b) Further, the contractor shall submit comprehensive remote monitoring philosophy for approval of the Engineer.

10. ENVIRONMENT

The UPS shall be designed for smooth continuous operation in the environment where it is installed. Alternatively, suitable Environment control measures shall be provided to maintain the environment within the design parameters.

11. SURGE SUPPRESSION

- (1) Critical and expensive electronic equipment should be protected from transient over-voltages by Transient Voltage Surge Suppressor. TVSS shall be put at the Input of each UPS and Bypass Stabilizer
- (2) The TVSS shall meet following primary requirements.

Surge Current Capacity :	25kA for 6 KVA UPS System, 50kA for 30 KVA UPS System, 100kA for 60 KVA UPS System, 160kA for 120 KVA UPS
Fault Current Capability :	> 12KA I/C
Connection Type :	Parallel
Fusing :	Individual Fusing of MOV's including N-G
Enclosure :	NEMA Tested
Mounting :	Wall Mounting or within Panel itself.

(3) TVSS - Detailed Specifications

- (a) TVSS shall be provided at the Input of each UPS and bypass Stabilizer and electrically located at the respective outgoing feeders in the Input Transformer Cubicle. Further TVSS shall be provided at each Outgoing Feeder of the UPS Output AC Distribution Panel. The ratings of the TVSS will be subject to approval.
- (b) The TVSS shall be constructed of Metal Oxide Varistor (MOV) technology and internal surge capacitors.
- (c) The surge protective devices shall be sized as per IEEE Std C62.41-1991 and IEEE Std C62.45-1992.

- (d) Surge protective devices used for three-phase, four-wire circuits shall be connected in all combinations of line-to-line, line-to-neutral, line-to-ground, and neutral-to-ground. (L-L, L-N, L-G, N-G). Devices used for single-phase, three-wire circuits shall be connected in all combinations of line-to-neutral and neutral-to-ground.(L-N, N-G).
- (e) The TVSS shall have a UL 1listing and labelled 1449-3 suppressed voltage rating of 800V peak.
- (f) The unit shall have a maximum continuous operating voltage (MCOV) rating of minimum 320VRMS.
- (g) The Response time of TVSS shall be ≤ 0.5 nanoseconds.
- (h) The TVSS shall provide up to 40dB for RFI & EMI noise attenuation.
- (i) TVSS monitoring shall consist of indicator lamps and form C dry contacts.
- (j) Monitoring of all modes, including N-E is required.

12. EXTERNAL STATIC TRANSFER SWITCH

- (1) This intelligent static transfer switch shall ensure instantaneous transfer of load between the two power sources (Buses). A static bypass transfer switch Module shall be provided as free standing cabinet. This will consist of two sets of 100% rated Static Switches – one for Source -1 and the other for Source -2.
- (2) The control unit shall contain an automatic transfer circuit that senses the status of both sources and alarm conditions to provide an uninterrupted transfer of the load without exceeding the transient limits specified herein. The smart control shall enable user to select the priority of source. Transfer time shall be adjustable with sensitivity control.
- (3) The static bypass transfer switch shall be a fully Solid State static switch having anti-parallel SCR's that has a maximum transfer time of less than 4 millisecond in Synchronised condition and less than 20 Millisecond in Unsynchronised condition. The static switch shall be capable of supplying 110% rated current for 60 minutes, 150% for 60 seconds and 1,000 % for 10 M.Sc.
- (4) The control panel shall Display status of incoming power source and the condition of static switch. Static Transfer Switch status shall be monitored through remote monitoring using RS 485 / MODBUS protocol. Minimum rating of 3 – phase switch shall be of 60 Amp.

13. SYSTEM EXPANSION

The UPS and Battery Backup system shall be designed and equipped with all necessary hardware, software and capacity for future 20% additional load.

14. TESTING AND INSPECTION

The UPS Systems shall be offered for Factory Acceptance Tests as specified in GS/PS. During Inspection, following Tests, but not limited to, will be witnessed:-

- (1) 8 Hour Heat Run Test of UPS Module at full load and normal temperature.
- (2) Regulation Test.

- (3) Test of Parallel Operation & current sharing of UPS Systems.
- (4) Transfer and retransfer Checks.
- (5) Synchronization test.
- (6) Overload capability test.
- (7) Short circuit capability test.
- (8) UPS efficiency Tests.
- (9) Tests for performance of operating parameters and controls.
- (10) Tests for various Alarm levels.
- (11) Battery Capacity/Backup Test (at Battery manufacturer's works).
- (12) Review of test reports for SCVS, Input Isolation Transformer and ACDB and
- (13) Review of UL 1449-3 Listing Certificate for the TVSS selected.
- (14) The battery discharge test shall be performed at a current corresponding to the inverter input current when the inverter is delivering its rated output full KW rating (i.e, KVA x0.8 p.f.).
- (15) The complete test schedule shall be as in standard formats of the vendor duly approved by the Engineer.
- (16) Vendor shall submit and get approval of the required drawings before call for inspection is given.

Annexure I of Appendix 1

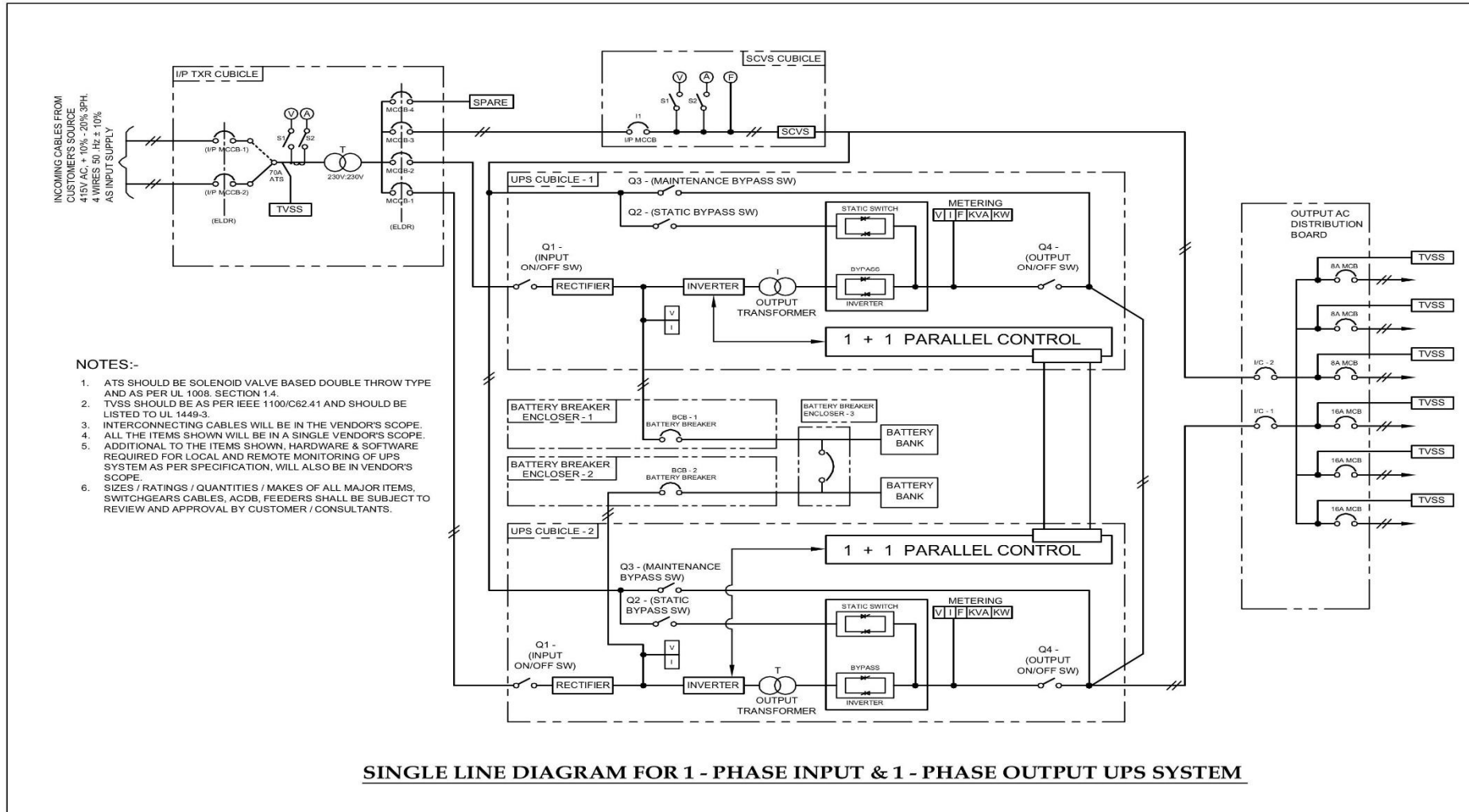

Annexure II of Appendix 2

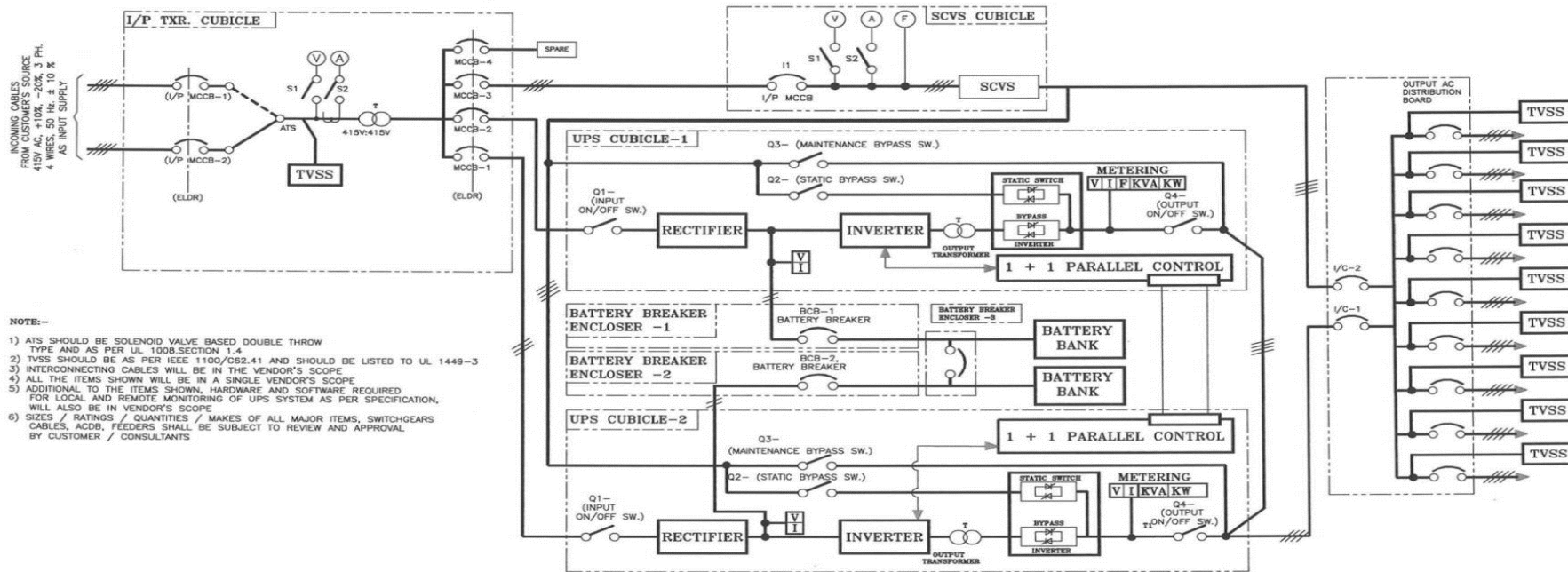

- NOTE:-
- 1) ATS SHOULD BE SOLENOID VALVE BASED DOUBLE THROW TYPE AND AS PER UL 1008, SECTION 1.4
 - 2) TVSS SHOULD BE AS PER IEEE 1100/C62.41 AND SHOULD BE LISTED TO UL 1449-3
 - 3) INTERCONNECTING CABLES WILL BE IN THE VENDOR'S SCOPE
 - 4) ALL THE ITEMS SHOWN WILL BE IN A SINGLE VENDOR'S SCOPE
 - 5) ADDITIONAL TO THE ITEMS SHOWN, HARDWARE AND SOFTWARE REQUIRED FOR LOCAL AND REMOTE MONITORING OF UPS SYSTEM AS PER SPECIFICATION, WILL ALSO BE IN VENDOR'S SCOPE
 - 6) SIZES / RATINGS / QUANTITIES / MAKES OF ALL MAJOR ITEMS, SWITCHGEARS CABLES, ACDB, FEEDERS SHALL BE SUBJECT TO REVIEW AND APPROVAL BY CUSTOMER / CONSULTANTS

SINGALE LINE DIGRAM FOR 3-PHASE INPUT & 3-PHASE OUTPUT UPS SYSTEM

(End of Appendix 1)

Appendix 2

Procedure Order For Cross Acceptance/Approval of Software Embedded Electronics Systems and New/Imported Technology Products for Railway Signalling for DFCCIL

(NOTE: These are general guidelines for DFCCIL. As there are no STEP items to be supplied in this work, the guidelines are applicable, if required, only for supply of Electronic Interlocking and Digital Axle counters)

1. PREFACE

- (a) These guidelines are meant for evaluating software embedded electronic systems and new/imported technology products for Railway signalling, which are already in use on a passenger carrying service anywhere in the world at speed more than 100KMPH, for adoption on DFCCIL using the concept of cross acceptance/cross approval. The procedure outlined in relevant CENELEC or any other equivalent standards to define and verify the safety requirements form the basis of these guidelines.
- (b) These guidelines are applicable for evaluation of equipment against valid Contract Agreement with DFCCIL. These guidelines are to be applied as per requirement of respective Contract Agreement.
- (c) These guidelines do not absolve the Contractor of his overall responsibility towards the relevant contract(s) in any manner whatsoever.

2. OBJECT

The object of these guidelines is to outline the process, activities, responsibilities and documentation necessary to carry out the Cross Acceptance / Cross Approval exercise by DFCCIL.

3. RESPONSIBILITY OF SAFETY ASSURANCE

- (a) Safety clearance shall be given adopting the guidelines pertaining to Cross Acceptance/Cross Approval for adoption on DFC. This will include the System Hardware & Software Platform, Application software for implementing Safety Functions, Communication Interfaces, Input/output modules, Power Supply (vital) Systems & other related equipment.
- (b) This approval for a particular product/system will be requested by the manufacturer of the system, through the Contractor. The manufacturer will be responsible for submission & authenticity of the documentation. The documentation should be as per procedure laid down.

4. APPLICATIONS

These guidelines shall be applied for evaluation & acceptance of all Software Embedded Electronic Safely Systems and New/Imported Technology Products for Railway Signalling for provision on DFC.

The Electronic systems/products are as under:

- (a) Electronic interlocking, Digital Axle Counters and Train Protection and Warning System
- (b) STEP items to be supplied on account of STEP loan conditions.

5. PROCEDURE

- (a) DFCCIL shall appoint an ISA for safety assessment of the equipment.
- (b) Contractor of the project shall ensure that manufacturer extends complete cooperation to DFCCIL/ISA/PMC.
- (c) Manufacturer shall depute his technical personnel for technical clarifications when required by DFCCIL/ISA/PMC.
- (d) The manufacturer/firm shall submit a Safety Plan to DFCCIL/ISA/PMC for evaluation of the System/equipment for Cross Acceptance/Approval. All documents shall be prepared in English language, checked & verified & marked appropriately indicating their version number, no. of alterations, etc.
 - (i) Safety plan shall be prepared and submitted. This will include:-
 - (1) System description which includes the system architecture/ configuration, system design & safety principle adopted for hardware & software.
 - (2) Safety Integrity Level of the system
 - (3) Safety case
 - (ii) Manufacturer shall check and verify that the system being offered meets the requirement of safety integrity laid down in the specifications.
 - (iii) Safety Case is documentary evidence that the safety system is conforming to and complies with the laid down safety requirements for it. Safety Case will have to be prepared in accordance with relevant CENELEC or equivalent standards & submitted to DFCCIL/ISA/PMC as the case may be for assessment. Safety case shall consist of the following documents:
 - (1) Details of approval given by an authority responsible for clearing safety system for use on a passenger carrying service at speed of more than 100 KMPH anywhere in the world.
 - (2) Standards to which the equipment have been developed and proposed to be supplied, i.e., CENELEC standard or any other equivalent standard adopted by that passenger-carrying Railway.
 - (3) Details of agencies, which have done software/hardware validations.
 - (4) Criteria adopted and assumption made.
 - (5) Documentation of these approvals, including trials, tests & measurements and simulation carried out.
 - (6) Restrictions, precautions, conditions or limitations imposed while giving clearance and thereafter action taken by the manufacturer.
 - (7) Calculations of Hazard rate or rate of unsafe side failure.
 - (8) Details/documents related to installation, functional operation,

- maintenance & modifications. Part list, wiring diagram, cable requirement, and list of tools and measuring equipment along with specification shall be given.
- (9) Performance feedback duly authenticated and certified by various user Railways.
 - (10) Name, Designation, Phone & FAX Nos. and address of the official certifying the performance feedback should be clearly available. This will include Mean Time Between Failures (MTBF) and Mean Time Between Wrong Side Failures (MTBWSF) and Mean Time To Repair (MTTR) figures as per format given in Annexure 'A'.
 - (11) Software & related instructions to configure the system initially as well as later due to changes in yard layout.
 - (12) Complete history of development of the equipment shall be given. Modifications carried out in the system, if any, during last five years shall be listed. Date of each modification with brief reasons for undertaking modification and whether modification has got approval of original validation/approving agency. Version No. allotted after each modification shall be mentioned.
 - (13) Type test (if required), Routine tests (which must be carried out on each equipment by the manufacturer) and acceptance tests (which are to be carried out on the equipment in the firm's premises before delivery) formats with test procedures and its significance for safety/reliability assessment of equipment. Sample routine test report/type test report/ factory acceptance test reports shall be submitted
 - (14) Details of climatic/EMI (Electro Magnetic Interference)/EMC (Electro Magnetic Compatibility) tests undergone by the equipment. Test reports of an accredited test laboratory (third party) shall be submitted. (The equipment shall also be subjected to environmental tests as per specification if not already done by some other reputed agency to the specified severity).
 - (15) Clause wise compliance statement to the specification and
 - (16) Statement whether system is suitable for DFC application or will require modifications. Updated history of application has to be submitted in the format as per Annexure 'B' for use in passenger carrying service at speeds of more than 100 kmph.
- (e) The Safety Integrity Requirement/Level for all vital applications for LC gates, station & Block Signalling & Interlocking systems / equipment / Track Circuits to be used on DFC, shall be SIL-4. In case, any system is required to have a SIL other than Safety Integrity Level-4 (SIL-4), DFCCIL approval shall be obtained before evaluating the system for Cross Acceptance.
 - (f) The evaluation for Cross Acceptance shall normally be in compliance to the relevant specifications.
 - (g) Provenness criteria of equipment usage of same Type/Make & Model/Version shall be as under: -

S No.	Category of Equipment/System	Minimum number of Equipment	Equipment Hours in use
1.	Digital Axle Counter	50	4,32,000
2.	TPWS (i) On Board Equipment (ii) Track Equipment Balise	25 100	2,16,000 8,64,000
3.	Electronic Interlocking	25	2,16,000
4.	Other items	100	8,64,000

Note 1: For all the above items: At least 20% of the equipment/system, with a minimum of 10, should be in continuous operation for a minimum period of 720 days.

Note 2: If the offered equipment has undergone minor hardware/software upgradation to improve functionality/safety of the equipment in recent past, then the equipment utilisation of the earlier version (prior to minor modifications) can be considered for the provenness. This decision of considering the earlier version for provenness shall be taken by DFCCIL. However, in such cases, a minimum of 10 (Ten) upgraded equipment should be in continuous operation for a minimum period of 180 days. Field trial of the equipment shall be conducted as detailed at Annexure C.

Note 3: STEP items to be supplied, as part of tied Japanese loan, if not deployed for commercial service anywhere shall be subjected to type test and field trial as detailed at Annexure 'C'.

- (a) The manufacturer shall have adequate skilled and trained manpower with good expertise in relevant fields of manufacturing, installation, training, maintenance support etc. Details of these personnel with name, educational qualification, training undergone & experience shall be furnished at the time of approval.
- (b) Manufacturer seeking approval shall guarantee for supply of spares during life of the equipment & extend maintenance support.
- (c) The firm shall provide all necessary test facilities to DFCCIL representative in their premises in India and abroad as prescribed by their principals at the time of approval.
- (d) DFCCIL/ISA/PMC shall assess the safety case & prepare the assessment report clearly recommending whether the system/equipment is permitted for:-
 - (i) Type test and trials
 - (ii) Field trials
 - (iii) Use on DFC
- (e) The type tests and field trials, as required, shall be conducted as per Annexure "C". After DFCCIL/ISA/PMC is satisfied with the documents submitted by the firm; results of the type test and field trial, if any; approval for the particular contract shall be given.
- (f) If any document of safety case is withdrawn or if any problem with the product arises, the supplier shall inform DFCCIL immediately. In such or any similar case DFCCIL may modify/withdraw the approval, as required.

Annexure 'A' of Appendix-2

1. Name of System/Equipment :
2. Make :
3. Model/Version No. :
4. User Railway & Section :
5. Maximum Sectional Speed :
6. Arrange number of Trains per day :
7. Application of System/Equipment :
8. Problems faced and solutions evolved :
9. Failure data may be submitted as per format given below :

Location	No. of System / Eqpt.	Date of commissioning	Total hours in use	No. of safe side failures	No. of unsafe failures	MTBF	MTBWSF	MTTR
Total								

Annexure 'B' of Appendix-2

Format for History of Application

SI NO	Hardware version No.	Software version No.	Model No.	User Rly.	Station/ Section	No. of Eqpts. In use	In use from date

Annexure 'C' of Appendix-2

Type test for signalling items

In case DFCCIL is fully satisfied with the consolidated report of the assessment, approval shall be given for type testing of prototype sample.

1. The type testing of prototype sample shall be undertaken to the satisfaction of DFCCIL.
2. Type tests shall be carried out on specific items to ensure that they perform their intended functions when subjected to all permutations and combinations of external environment and other factors.
3. The following tests shall constitute type tests :
 - (i) Visual inspection tests
 - (ii) Insulation resistance tests
 - (iii) Card level functional and fail safety tests
 - (iv) System level functional and fail safety tests
 - (v) Computerized testing
 - (vi) EMI/EMC tests
 - (vii) Environmental / Climatic Tests
 - (viii) System Diagnostic Tests
 - (ix) System Software Test
 - (x) Any other test deemed necessary
4. Manufacturer shall submit a comprehensive type test plan including procedure, type test format and expected results. The type test plan shall be finalized in consultation with DFCCIL / ISA / PMC.
5. Type tests shall be carried out at manufacturer's premises. Necessary testing equipment and competent man power shall be made available by the manufacturer.
6. Type test shall be carried out by DFCCIL representative / ISA.
7. Tests which cannot be carried out in house may be referred to independent test house of repute.
8. EMC / EMI tests may not be required if previous independent witness tests have been successfully carried out and reported by document.

Field trials for signalling items

1. The field trials shall be conducted to the satisfaction of the DFCCIL.
2. The field trials shall be held on Indian Railways / DFC as decided by DFCCIL. DFCCIL shall coordinate with IR for this purpose.
3. The Contractor / Manufacturer shall make all arrangements for conducting field trials. This shall include; but not limited to; supply, installation, commissioning and monitoring of the equipment.
4. The trials shall be monitored in the following manner –

S N	Name of Division / Railway / Section	Name of station	Model and version no.	Date of installation	No. of failures*	Remarks

* Analysis of cause of failures to be attached.

Duration of field trial

SN	Item / Equipment	Initial trial	
		Number of equipment	Duration
1.	EI	01	180 days in parallel and/or standalone mode or a combination thereof as decided by DFCCIL
2.	DAC	01	180 days in parallel and/or standalone mode or a combination thereof as decided by DFCCIL
3.	TPWS	One (01) set of on Board equipment and ten (10) sets of track side system shall be installed and detailed trials shall be conducted for 180 days for compliance to specifications and performance monitoring.	

NOTE:

1. The number of equipment and duration can be suitably revised, as required, by DFCCIL.
2. DFCCIL shall decide if field trials and type test can proceed simultaneously or not.

(End of Appendix 2)

Appendix 3

Drawings for Cable Laying

S. No.	Description	Drawing No.	Annexure No. of Appendix 3
1.	Joint Procedure Order for undertaking digging work in the vicinity of underground signalling, electrical and telecommunication cables		Annexure - I
2.	DFCC Cable laying in Station yard	GGM/Signal/Indicative Drawing No.:1	Annexure – II(a)
3.	DFCC Cable laying in Block Section	GGM/Signal/Indicative Drawing No.:2	Annexure – II(b)
4.	Cable trench	SDO/CABLE LAYING/003	Annexure - III
5.	Laying of cables in rocky area	SDO/CABLE LAYING/008	Annexure - IV
6.	Track crossing	SDO/CABLE LAYING/009	Annexure - V
7.	Road crossing	SDO/CABLE LAYING/010	Annexure - VI
8.	Cable laying on culverts with low flood level	SDO/CABLE LAYING/011	Annexure - VII
9.	Cable laying on culverts with high flood level	SDO/CABLE LAYING/012	Annexure - VIII
10.	Cable laying on metallic bridges	SDO/CABLE LAYING/013	Annexure - IX
11.	Cable Trough for metallic bridges	SDO/CABLE LAYING/014	Annexure - X

Note: The sketches' given are indicative. The detailed drawings shall be proposed by the Contractor and approved by the Engineer.

Annexure-I of Appendix 3

JPO No. 1/SG/2004

(Issued under CRB's letter No. 2004/Sig/G/7 dated 17.12.2004)

JOINT PROCEDURE ORDER FOR UNDERTAKING DIGGING WORK IN THE VICINITY OF UNDERGROUND SIGNALLING, ELECTRICAL AND TELECOMMUNICATION CABLES

- A. A number of Engineering works in connection with gauge conversion/doubling/third line are in progress on various railways, which require extensive digging work near the running track, in close vicinity of the working S&T cables carrying vital safety circuits as well as electrical cables feeding the power supply to Cabins, ASM room, RRI Cabin, Intermediate Block Huts (IBH) etc. Similarly, S&T organization under open line or construction units under CAO/C are executing various signalling and telecommunication works requiring digging of earth for laying of cables or casting of foundations of the erection of signal posts etc. RailTel are also executing the work of laying of quad cable and OFC on various Railways as a part of sanctioned works for exclusive use of Railways for carrying voice and data i.e. administrative and control communication, PRS, FOIS etc. or shared by RailTel Corporation of India Ltd. On certain sections digging is also required for laying of electrical cable and casting of foundation for erection of OHE masts by Electrical Deptt. Generally, these works are executed by contractors employed by these organizations.
- B. However, while carrying out these works in the vicinity of working signalling, telecommunication and electrical cables, at times, cable cuts take place due to JCB machines working along the track or during the digging work being done by Contractors carrying out the Civil Engineering Works. Similarly, such cable cuts are also resulting due to works undertaken by S&T or Electrical Depts. Such Cable faults results in the failure of vital signalling and telecommunication circuits.
- C. Henceforth, the following joint procedure shall be followed by Engineering, Electrical and S&T (and RailTel Organization, wherever such works are being done by them) Officers of the respective divisions and by the Construction Organization, while carrying out any digging work near to existing signalling & telecommunication and electrical cables, so that the instances of cable cut due to execution of works can be controlled and minimized.
- (1) S&T Department (and RailTel, where they have laid the cables) & Electrical Depts. shall provide a detailed cable route plan showing exact location of cable at an interval of 200m or wherever there is change in alignment so that the same is located easily by the engineering official/contractor. This cable route plans shall be made available to the DSE/DEN or Dy. CE/C as the case may be by Sr. DSTE/DSTE or Sr. DEE/DEE of the divisions or Dy. CSTE/C or Dy. CEE/C within a reasonable time in duplicate. DSE/DEN or Dy. CE/C will send copies to their field unit i.e. AEN/SE/P. Way & works.
 - (2) Before taking up any digging activity on a particular work by any agency, Sr. DSTE/DSTE or Sr. DEE/DEE of the section shall be approached in writing by the concerned Engg. or S&T or Electrical officer for permitting to undertake the work. After ensuring that the concerned executing agencies including the contractor have fully understood the S&T and Electrical cable route plan shall permit the work in writing.
 - (3) After getting the permission from S&T or Electrical Deptt. as the case may be, the relevant portion of the cable route plan shall be attached to the letter through

which permission is issued to the contractor by concerned Engg. official for commencement of work and ensuring that the contractors have fully understood the cable route plan and precautions to be taken to prevent damage to the underground cables. The contractor shall be asked to study the cable plan and follow it meticulously to ensure that the safety of the cables not endangered. Such a provision, including any penalty for default, should form part of agreement also. It is advisable that a suitable post of SE (Sig) or SE (Tele) or SE (Elect) shall be created chargeable to the execution of the work. However basic responsibility will be of the Department executing the work and the Contractor.

- (4) The SE (P.Way) or SE (Works) shall pass on the information to the concerned SE (Sig) or SE (Tele) or SE (Elect) about the works being taken up by the contractors in their sections at least 3 days in advance of the day of the work. In addition Engineering control shall also be informed by SE (P.Way) or SE (Works), which in turn shall pass on the information to the Test Room/Network Operation Centre of RailTel/TPC/Electrical Control.
- (5) On receiving the above information, SE (Sig) or SE (Tele) or SE (Elect) shall visit the site on or before the date of taking up the work and issue permission to the contractor to commence the work after checking that adequate precautions have been taken to avoid the damage to the cables. The permission shall be granted within 3 days of submission of such requests.
- (6) The name of the contractor, his contract telephone number, the nature of the work shall be notified in the Engineering Control as soon as the concerned Engg. official issued the letter authorizing commencement of work to the contractor. Test Room be given a copy and Test Room shall collect any further details from the Engineering Control and shall pass it on to S&T/RailTel & Elect. officials regularly.
- (7) In case of works being taken up by the State Government, National Highway Authority etc., the details of the permission given i.e. the nature of work, kilometer etc. be given to the Engineering Control including the contact person's number so that the work can be done in a planned manner. The permission letter shall indicate the contact numbers of Test Room/Network Operations Centre of RailTel/TPE/Elect. Control.
- (8) Where the nature of the work taken by the Engineering department is such that the OFC or other S&T cables or Electrical cables is to be shifted and relocated, notice of minimum one week shall be given so that the Division/RailTel/Construction can plan the works properly for shifting. Such shifting works shall, in addition, for security and integrity of the cables, be supervised by S&T Supervisors/RailTel Supervisors/Electrical Supervisors.
- (9) The concerned SE(P.Way)/SE(Works)/SE(Sig)/SE(Tele)/SE(Elect.) or RailTel supervisors, supervising the work of the contractor shall ensure that the existing emergency sockets are not damaged in view of their importance in providing communication during accident/emergency.
- (10) In case of minor nature of works where shifting of cable is not required, in order to prevent damage to the cable, the Engineering Contractor shall take out the S&T or optical Fiber cable or Electrical cable carefully from the trench and place it properly alongside at a safe location before starting the earthwork under the supervision of SE (Sig) or SE (Tele) or SE (Electrical). The cable shall be reburied soon after completion of excavation with proper care including placement of the brick over

the cable by the concerned S&T Supervisors or Electrical Supervisors. However, the work will be charged to the concerned engineering work.

- (11) In all the sections where major project are to be taken up/going on RailTel/S&T Dept. shall deploy their official to take preventive/corrective action at site of work.
- (12) No new OFC/Quad cable shall be laid close to existing track. It shall be laid close to Railway boundary as per extant instructions i.e. 1.0 m from the Railway boundary to the extent possible to avoid any interference with future works (doubling etc.). It shall be ensured in the new works of cable laying that the cable route is properly identified with electronic or Concrete markers. Henceforth, wherever cable laying is planned and before undertaking the laying work, the cable route plan of the same shall be got approved from the concerned Sr. DEN or Dy. CE/ Con. to avoid possible damages in future. Such approvals shall be granted within 7 days of submission of the requests.
- (13) The works of excavating the trench and laying of the cable should proceed in quick succession, leaving a minimum time between the two activities.
- (14) Any damage caused to OFC/Quad cable or Electrical cable during execution of the work, necessary debit shall be raised on Engineering Department who shall bear the cost of the corrective action.
- (15) All types of bonds i.e. rail bond, cross bond and structure bond shall be restored by the Contractor with a view to keep the rail voltage low to ensure safety of personnel.
- (16) Above joint circular shall be applicable for construction as well as open line organization of Engineering, S&T & Electrical.
- (17) The S&T cable and Electrical cable route plan should be got approved from the concerned Sr. DSTE/DSTE & Sr. DEE/DEE respectively, before undertaking the work and completion cable route plan should be finalized Block section by Block section as soon as the work completed.

NOTE: Various designations mentioned in the above Joint Procedure Order are for Railways. In the DFCCIL work, all approvals/inspections will be by the Engineer rather than the designated officials mentioned in the above Joint Procedure Order.

Annexure-II (a) of Appendix 3

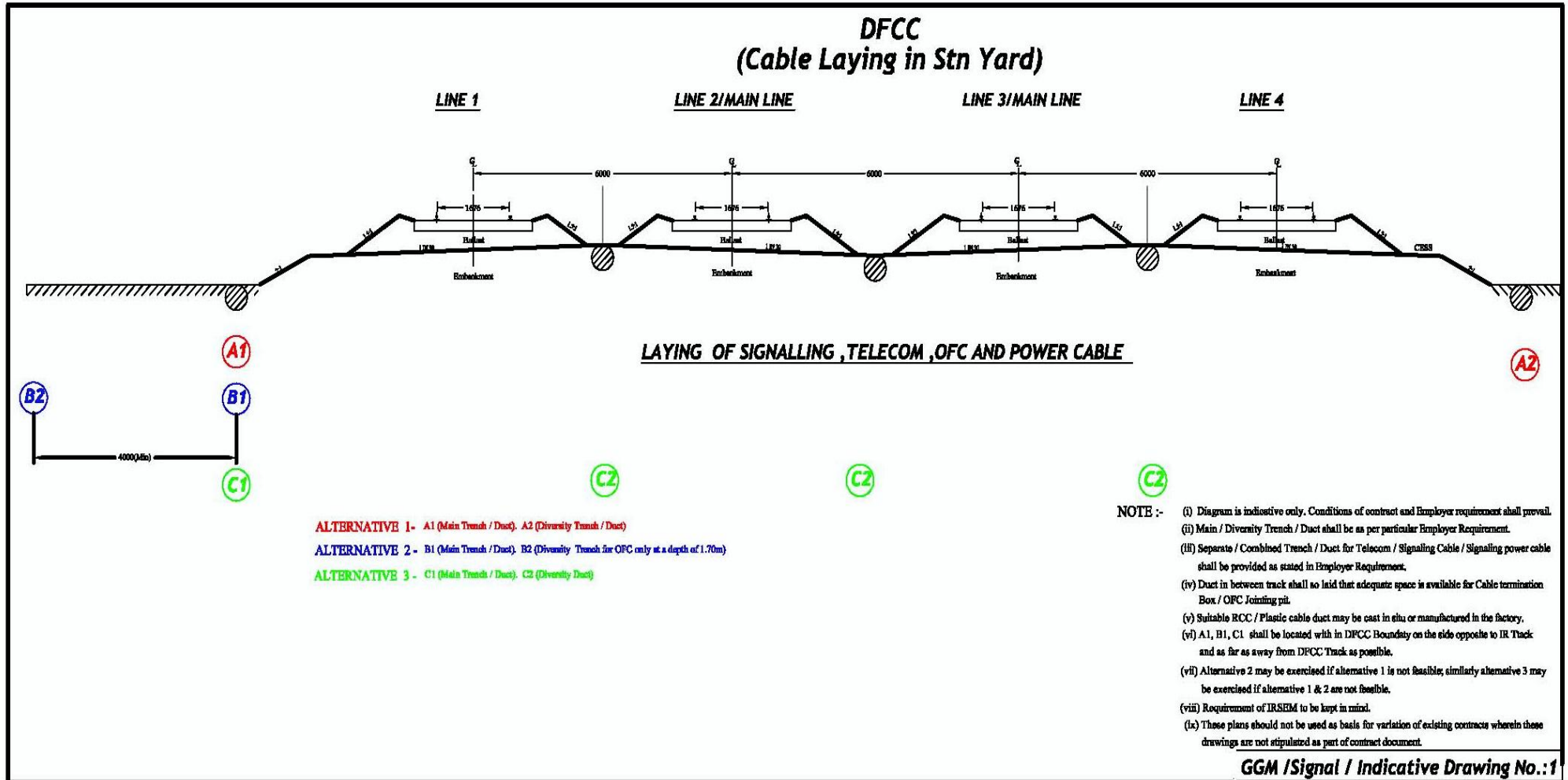

Annexure-II (b) of Appendix 3

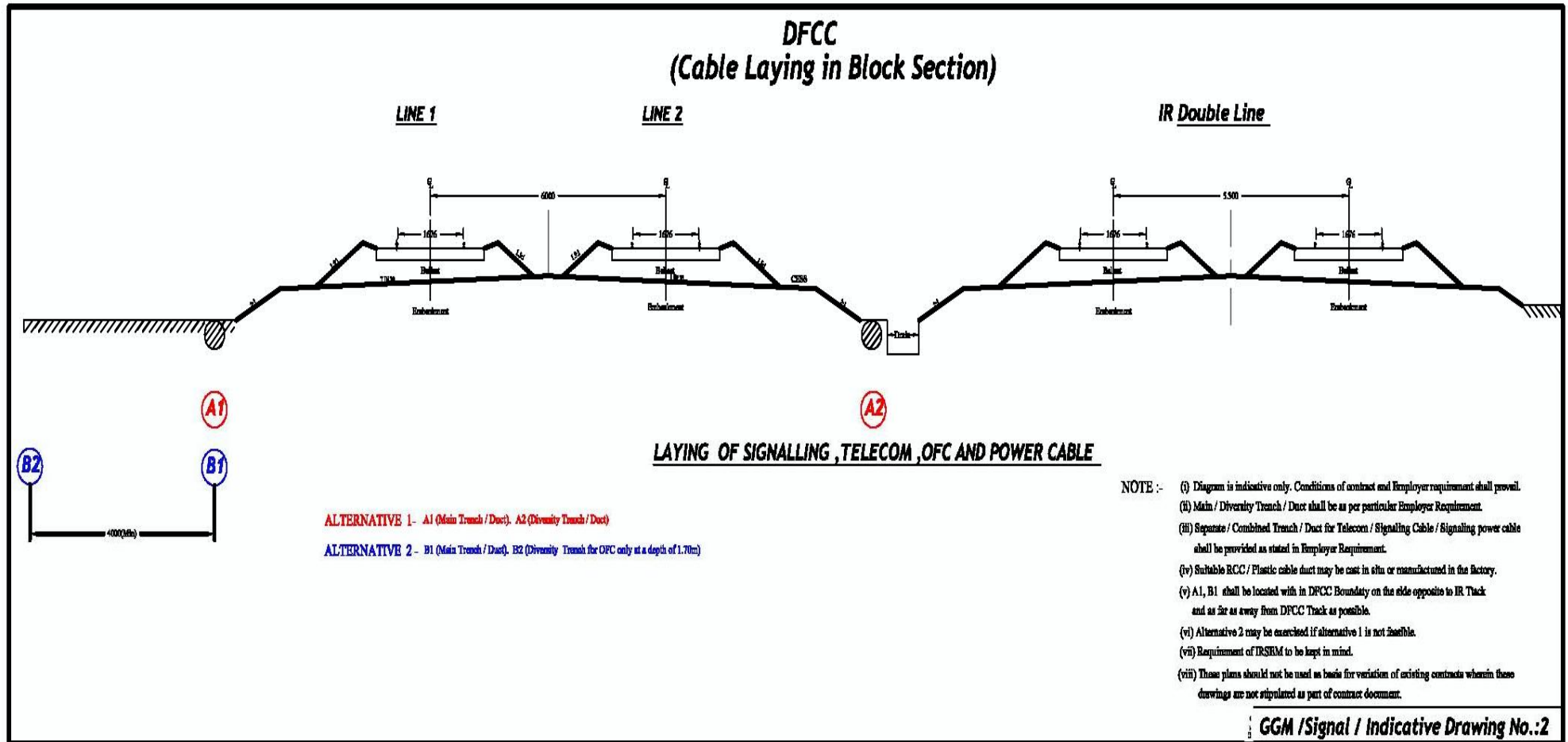

Annexure III of Appendix 3

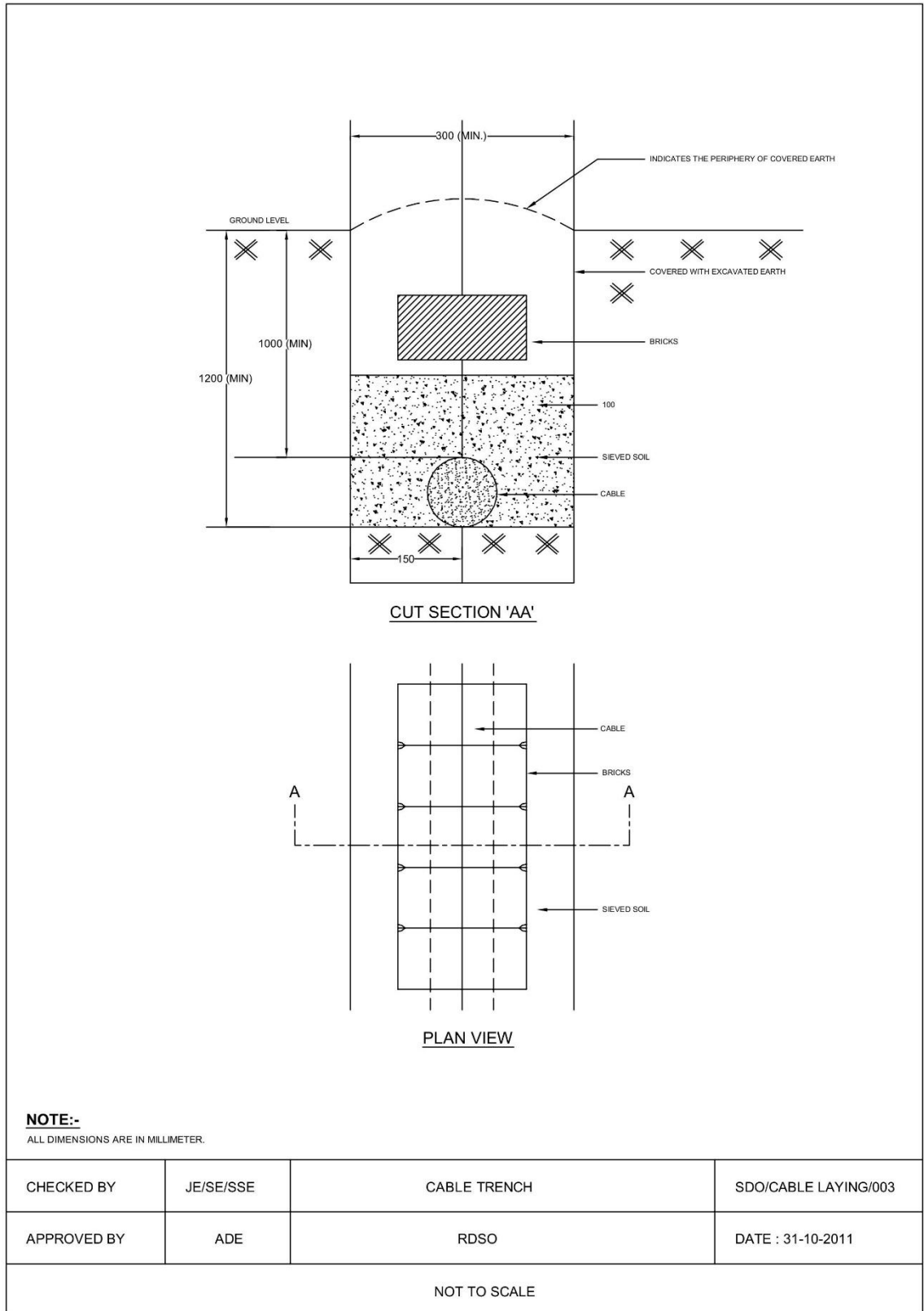

Annexure-IV of Appendix 3

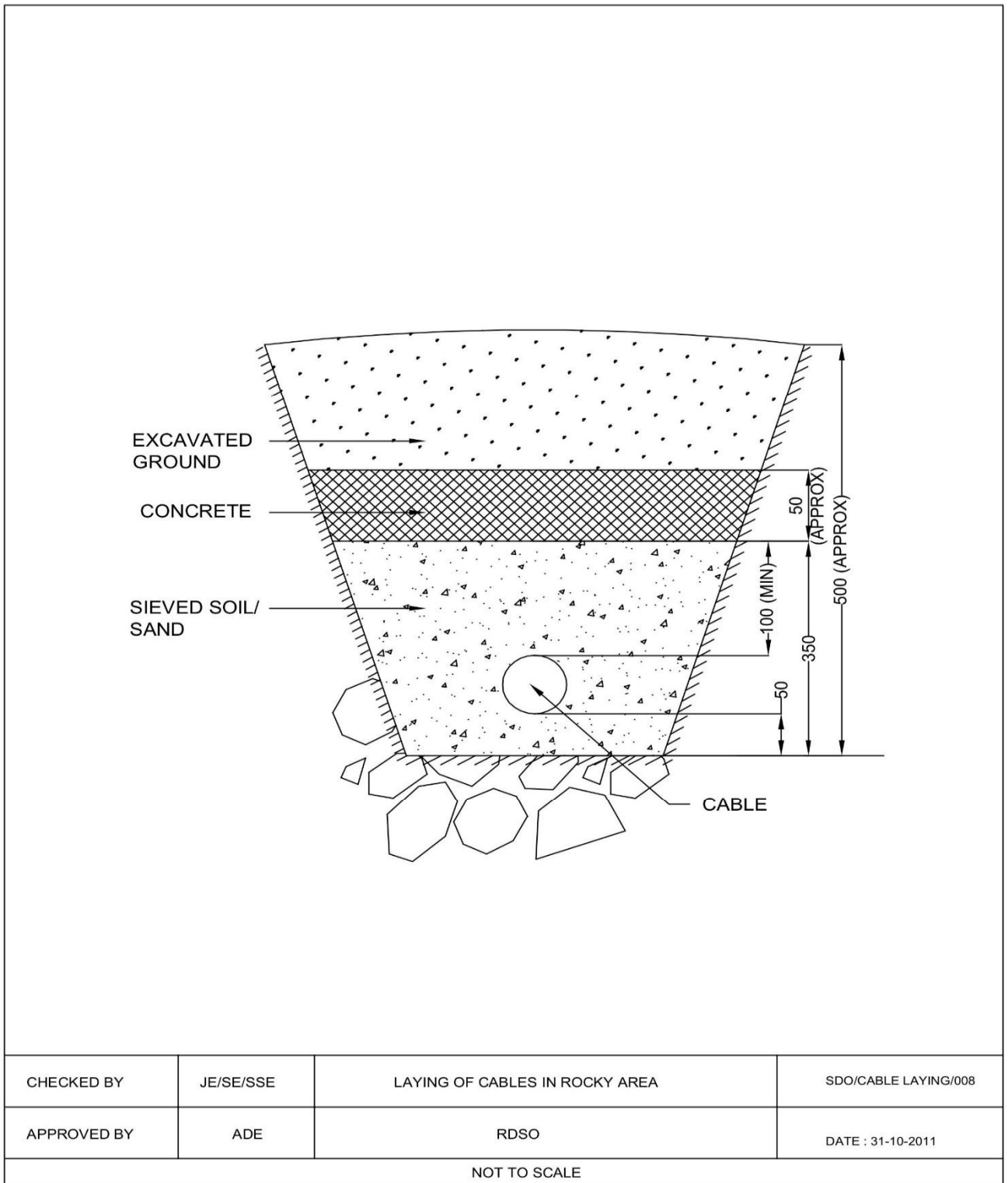

Annexure-V of Appendix 3

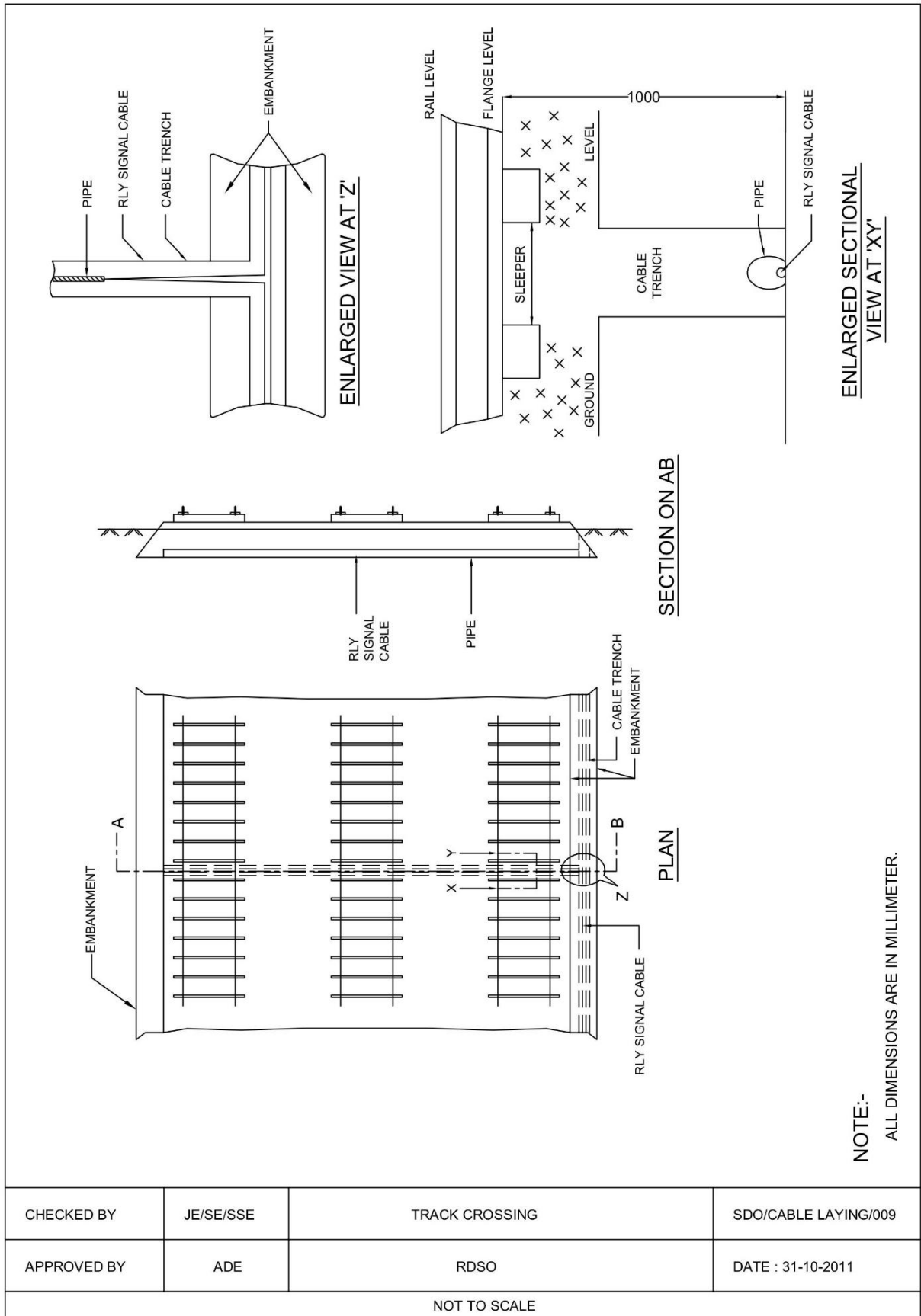

Annexure-VI of Appendix 3

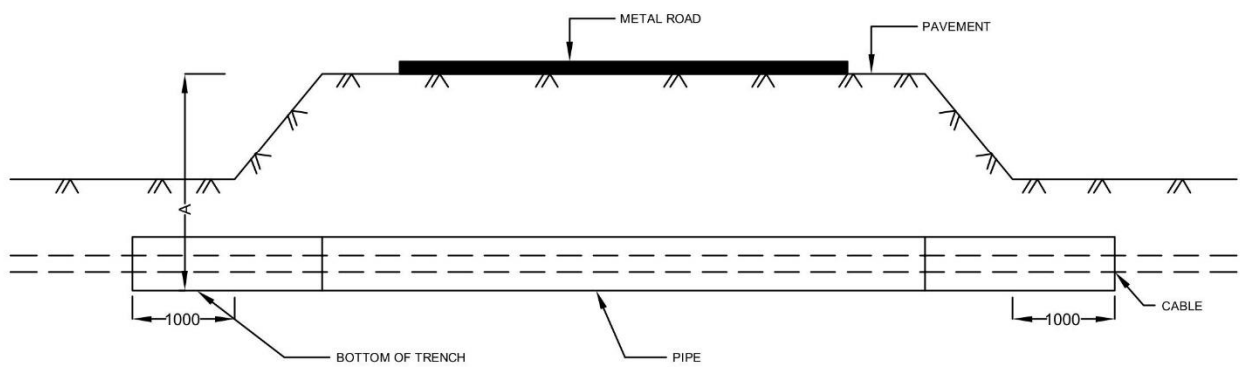

ALL DIMENSIONS ARE IN MILLIMETER.

CHECKED BY	JE/SE/SSE	ROAD CROSSING	SDO/CABLE LAYING/010
APPROVED BY	ADE	RDSO	DATE : 31-10-2011
NOT TO SCALE			

Annexure-VII of Appendix 3

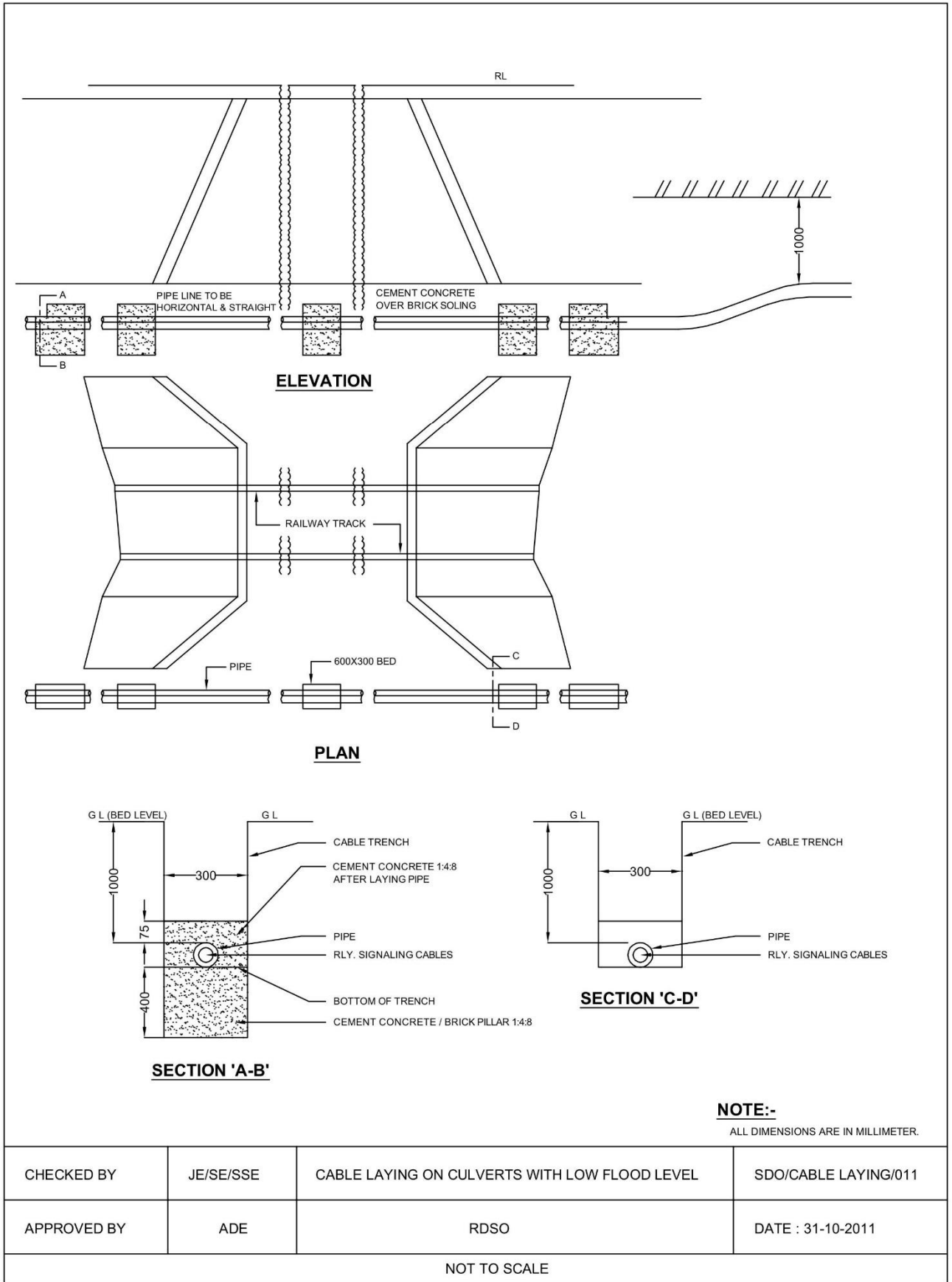

Annexure-VIII of Appendix 3

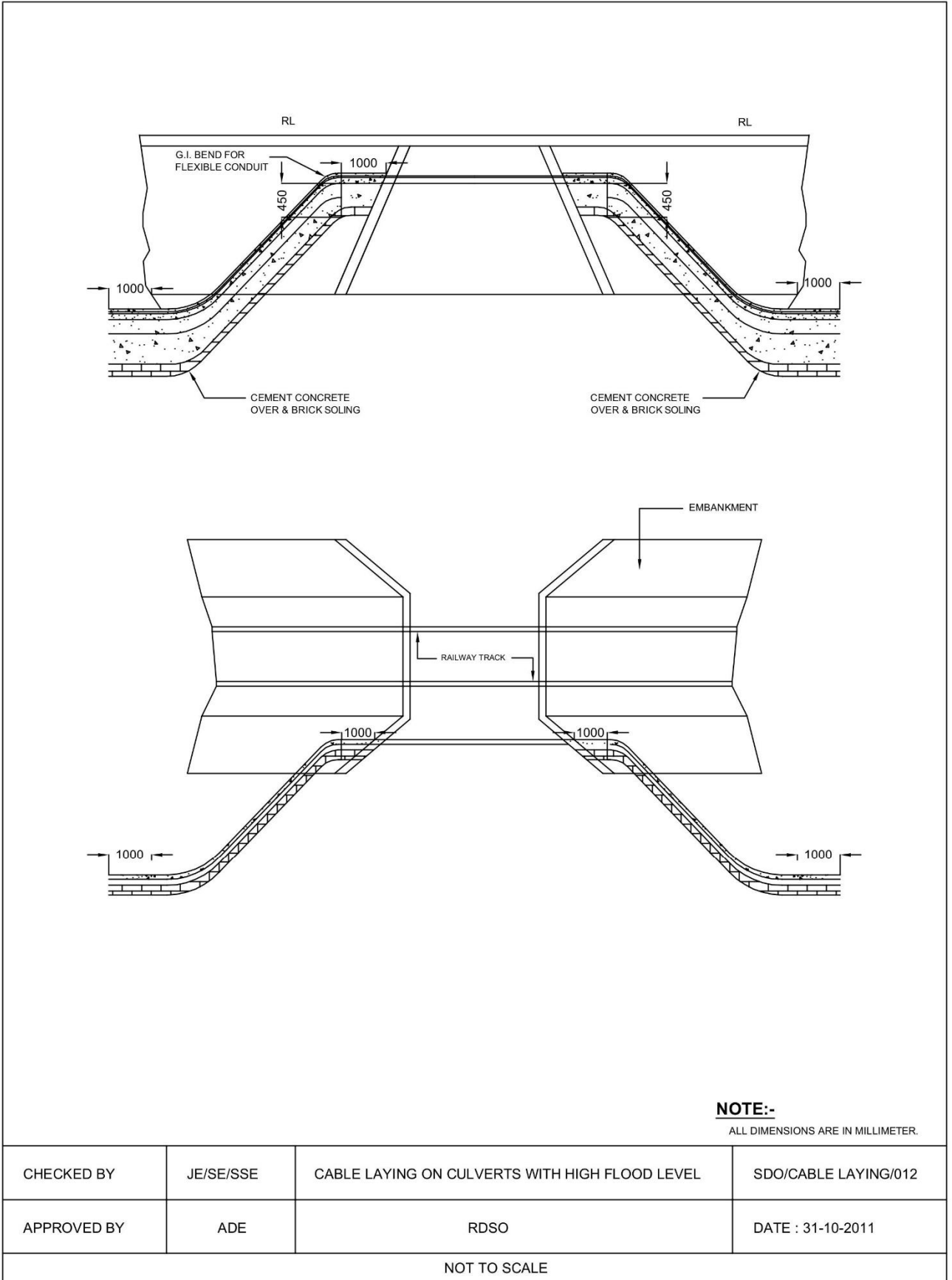

Annexure-IX of Appendix 3

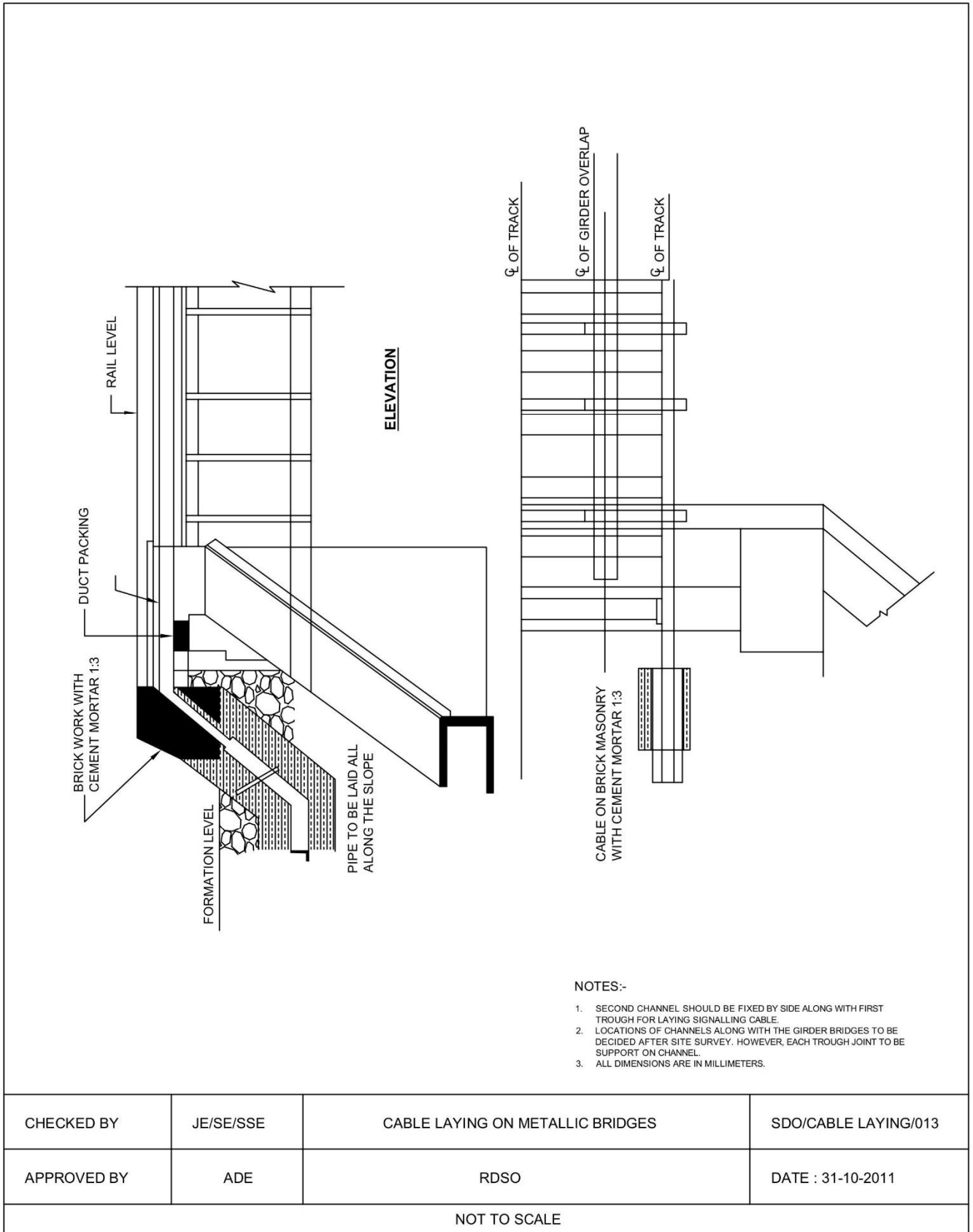

Annexure-X of Appendix 3

Sl. No.	DESCRIPTION	No. REQD.
1	TROUGH	2.23 METERS LONG
2	COVER	2.0 METERS LONG
3	STRAP	
4	BOLT HEAD (8mm DIA X 32mm)	
5	NUT FOR ABOVE	
6	LOCK NUT FOR SL	
7	SPRING WASHER FOR SL	
8	PLAIN WASHER FOR SL	

NOTE:-

- AFTER TIGHTENING NUTS FOR FIXING STRAP, THE THREAD OF THE BOLT MAY BE BURIED TO PREVENT THEFT.
- CABLE THROUGH TO BE FITTED TELESCOPICALLY.
- NO WELDING SHALL BE DONE ON ANY COMPONENT FOR FABRICATIONS.
- THROUGH TO BE FABRICATED OUT OF GALVANIZED STEEL SHEET TO IS:277-1985 WITH FOLLOWING STIPULATIONS THICKNESS MINIMUM 1.6mm. GRADE OF ZINC COATING 200.
- ALL DIMENSIONS ARE IN MILLIMETER.

CHECKED BY	JE/SE/SSE	CABLE TROUGH FOR METALLIC BRIDGES	SDO/CABLE LAYING/014
APPROVED BY	ADE	RDSO	DATE : 31-10-2011

NOT TO SCALE

(End of Appendix 3)

Appendix 4

Typical Scheme of Track Vacancy Detection System Using MSDAC in Automatic Block Section

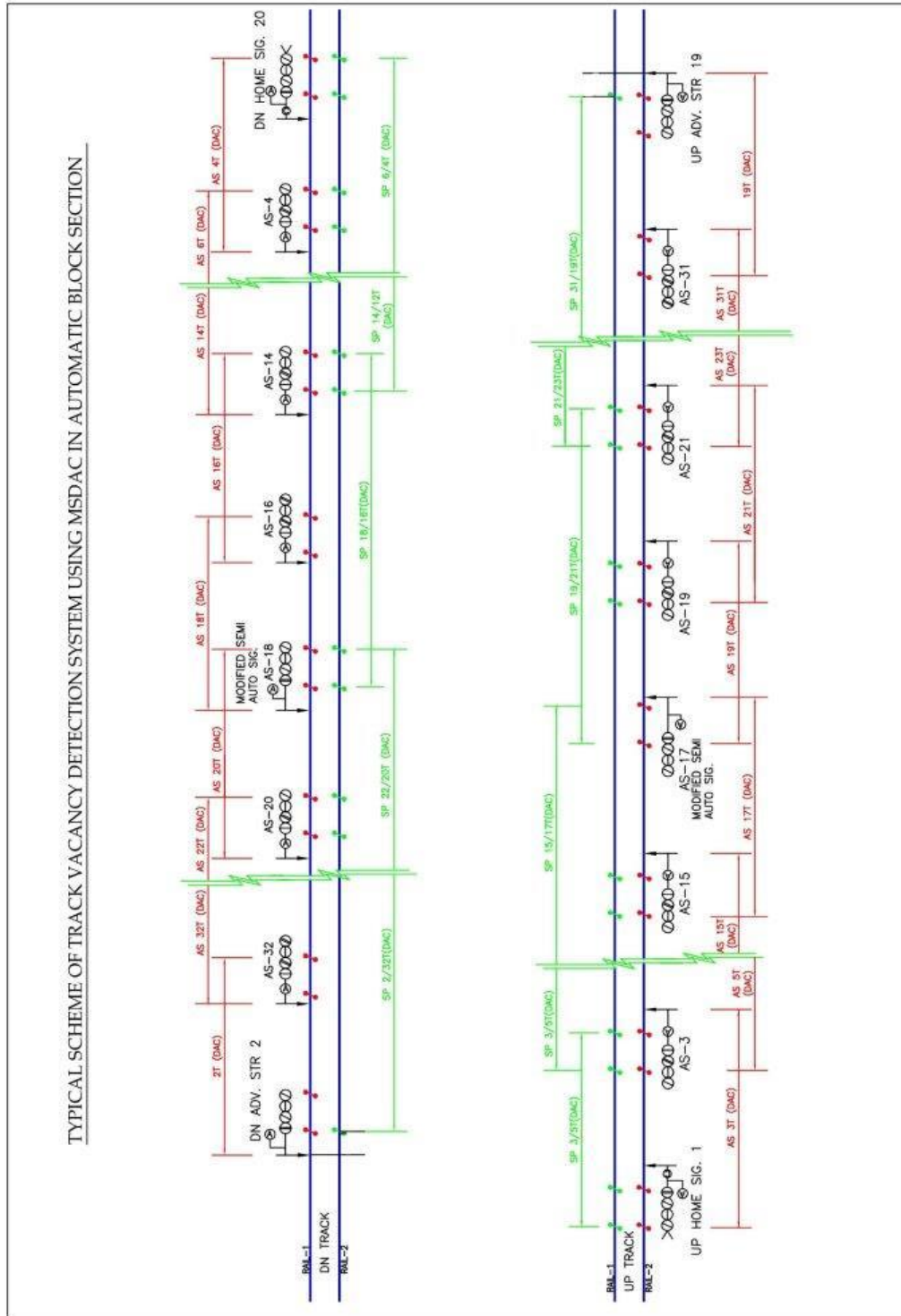

(End of Appendix 4)

Appendix 5

Earthing & Bonding Connections

Earthing & Bonding connections Drawing for:

- (1) Typical Earthing and Bonding arrangement for Indoor Signalling equipment - Annexure-I of Appendix 5
- (2) Typical Earthing, Bonding and Surge Protection arrangement for Location Box having Electronic Equipment – Annexure-II of Appendix 5.

Note: The sketches' given are indicative. The detailed drawings shall be proposed by the Contractor and approved by the Engineer.

Annexure-I of Appendix 5

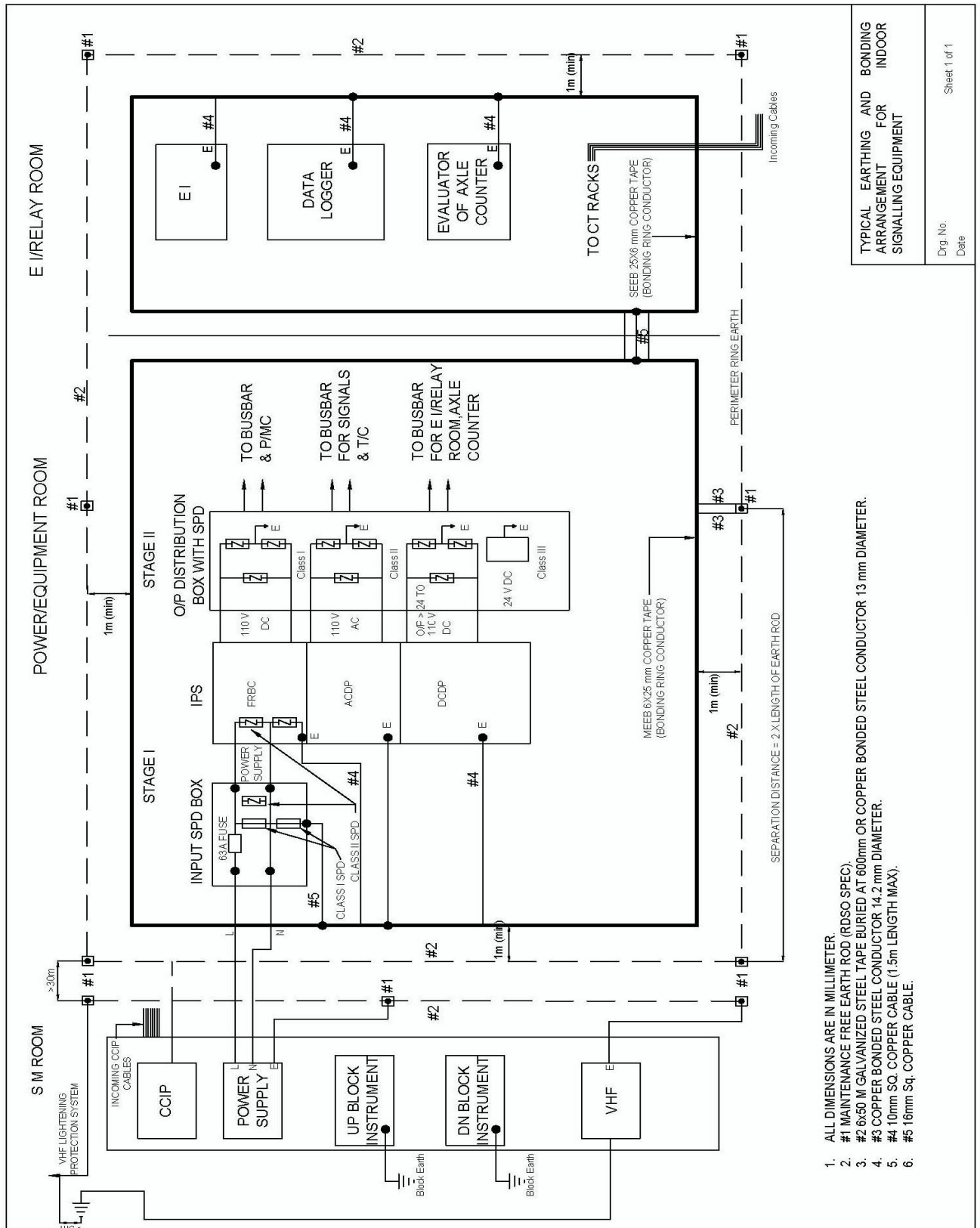

1. ALL DIMENSIONS ARE IN MILLIMETER.
2. #1 MAINTENANCE FREE EARTH ROD (RDSO SPEC).
3. #2 6x50 M GALVANIZED STEEL TAPE BURIED AT 600mm OR COPPER BONDED STEEL CONDUCTOR 13 mm DIAMETER.
4. #3 COPPER BONDED STEEL CONDUCTOR 14.2 mm DIAMETER.
5. #4 10mm SQ. COPPER CABLE (1.5m LENGTH MAX).
6. #5 16mm Sq. COPPER CABLE.

TYPICAL EARTHING AND BONDING ARRANGEMENT FOR INDOOR SIGNALLING EQUIPMENT

Dwg. No. _____
 Date _____
 Sheet 1 of 1

Annexure-II of Appendix 5

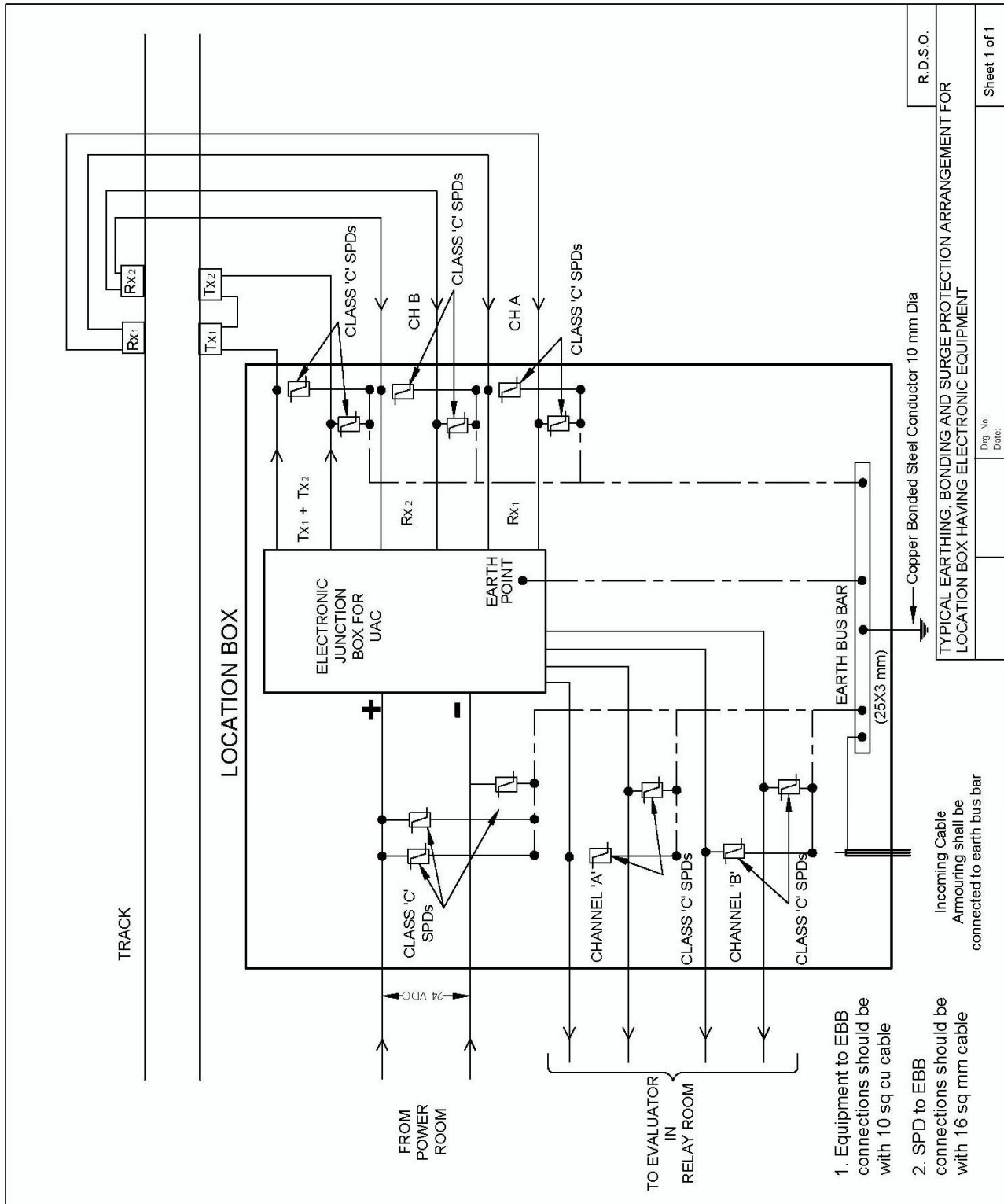

(End of Appendix 5)

Appendix 6

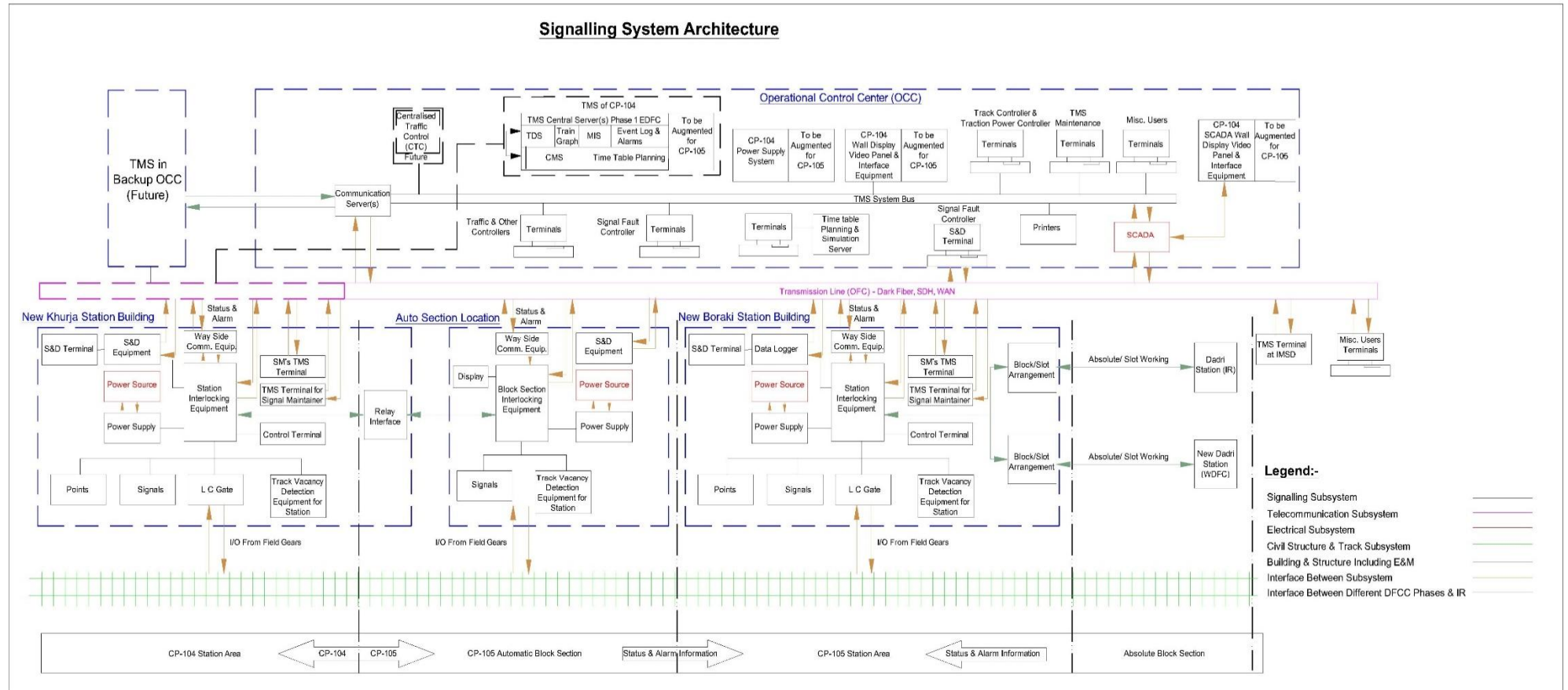

Appendix 7

Train Management System being provided in Bhaupur - Khurja Section (EDFC-1)

1. INTRODUCTION

- (1) The Train Management System (TMS) shall be computer based information storage cum retrieval system located in the Operational Control Centre (OCC). The system shall collect signalling information from various Station and Block section interlocking on real time basis. It shall also collect the train identification information from the train originating stations normally retrieved from Time Table or keyed in by concerned Traffic Controller/SM.
- (2) The TMS shall enable supervision of the traffic operation from a single control point (OCC). It shall automatically perform routine data logging and recordings to assist the operations.

2. SCOPE

- (1) The Train Management System shall, broadly comprise of, but not limited to, the following:
 - (a) Central Server at OCC.
 - (b) Simulation Server at OCC.
 - (c) Communication Server and Communication network at OCC.
 - (d) Video Wall Display System at OCC.
 - (e) TMS Terminals for Controllers at OCC.
 - (f) Terminals for Simulation, Time Table Planning and Maintenance at OCC.
 - (g) TMS Terminals for Station Master at Stations.
 - (h) TMS Terminals for Maintenance at Station, IMD & IMSD.
 - (i) TMS Terminals for Crew Management.
 - (j) Miscellaneous User terminals.
 - (k) Communication Network & Way Side Communication Equipment at Wayside EI.
 - (l) TMS System Software.
 - (m) Interfacing with Traction Power SCADA.
 - (n) Interfacing with Master Clock System.
 - (o) Printers, Plotter, Cable, Connector and other accessories.
- (2) The Central Server, Simulation Server and Communication Server at (a), (b), (c) above should be such as to guarantee the performance requirements specified in Para 3(12) & 3(13), Para 3(32) and Para 4 (3)(a) of this Appendix.

3. SYSTEM REQUIREMENTS

- (1) The Train Management System shall include Video Wall Display System at OCC Theatre for real-time geographical representation of the complete Signalling System of Bhaupur-Khurja section, including Single Line Tracks connecting DFCCIL Junction Stations to IR Stations. Video Wall Display System shall include Video Wall Display Panel, Display Wall controller, Servers, Firmware/Software, Local Communication Network etc.
- (2) The Video Wall Display System for SCADA System shall also be provided under this PS (Signalling Works). It shall take the inputs for real time indications from the SCADA System being provided under Particular Specifications – 2x25 kV AC Traction Electrification and Associated Works. Workstations with Traction Power Controllers for SCADA System will be provided under Particular Specifications – 2x25 kV AC Traction Electrification and Associated Works.
- (3) The Train Management System shall include TMS Terminals at desk of Controllers at OCC for display of real time status of complete Signalling System. TMS Terminals at OCC shall be provided for Chief Controller, Dy Chief Controller, Traffic Controller(s), Assistant Controller, Track Controller, Traction Power Controller and Signal Fault Controller. One Terminal each shall also be provided at OCC as Maintenance Terminal and Training Terminal.
- (4) The Train Management System shall include TMS Terminals at desk of Station Master in every Junction/Crossing Stations for display of real time status of Signalling System. One Terminal each shall also be provided at Junction Stations, Crossing Stations, IMD and IMSD. The Train Management System shall include Miscellaneous User terminals at important office/ locations such as IR Junction stations, IR Divisional and Zonal offices, DFCCIL Regional and Corporate offices etc.
- (5) For providing overview of complete Signalling System, fixed Geographical Data(Stations Yard Layout, Block Sections Layout, Single Line Tracks Layout between DFCCIL Junction Stations to IR Stations, LC Gates, Points, Signals, Axle Counter Track Sections, Routes, Wayside EI Locations etc.), Working Time Table etc. shall be available in Central Database of Train Management System. Further for providing real time status of complete Signalling System, Train Management System on real time basis shall automatically acquire data pertaining to status of Signalling Functions/Equipment (Signal aspects, Points position, Signal Failure, Points Failure, Route Set/Release status, Axle Counter Track Section Clear/Occupied/Error, LC Gate Open/Close/fail, Vital relay Picked-Up/Dropped, Mismatch between EI Output & Corresponding Relay, IPS/UPS, ELD, Alarms, Signalling Equipment Rooms Opening/Closing etc.) from Electronic Interlocking provided at Stations and in Block Sections (if any).
- (6) The Train Management System shall include Train Describer System to associate a train with an alpha-numeric ID. This Train Describer System shall enable identification of all trains as they move, and display real time information of their position and movements. The train Id shall automatically move and advance as the train moves/advances.
- (7) The Train Management System shall also include Train Graph Function for plotting and display of Train Graph. These Train Graph shall be available at TMS Terminals provided with Chief Controller, Dy Chief Controller, Traffic Controller(s) and Signal Fault Controller.

- (8) The Train Management System shall include required software for offline planning of Time Table for Train Operation. The TMS shall also include required software for generation of Management Reports pertaining to Train Operation. These Management Reports will be used to measure the operational performance of the DFCCIL.
- (9) The Train Management System shall include Time Table Planning & Simulation System to simulate and observe effect of various parameters on Train Operation.
- (10) The Train Management System shall include Crew Management System for management of crew.
- (11) The Train Management System shall include Event Log & Alarm System for logging of events related to the control and movements of trains and generating alarms.

(12) System Response Time

- (a) The system shall be so designed so as to achieve the overall objective of providing real time information related to train operation.
- (b) Following response time shall be considered in design:
 - (i) The response time between a change of state of signalling gear at a wayside station and its display at OCC shall not be greater than 2 seconds.
 - (ii) The time taken between initiation of a query relating to data /result /report and its response on terminals shall be as small as possible.

(13) TMS Capacity

- (a) The TMS system shall have adequate capacity to handle data for 300 trains per day both ways and Signalling System being provided under this Contract.
- (b) Further, additional 20% capacity shall be built in for future expansion.

(14) Video Wall Display Panel

- (a) The Signalling system and SCADA system of Bhaupur-Khurja section shall be displayed on separate Video Wall Display Panels. Black background shall be used for getting proper contrast. Other colours used shall be such as to give bright and easily distinguishable display.
- (b) The Video Wall Display Panel for Signalling system shall display all the Track sectioned lines from Bhaupur to Khurja including yard layout of the stations.
- (c) The Video Wall Display Panel unit for Signalling system shall display important indications of Station Control terminal, Signal aspects, Points, Track sections, LC gates. EIs etc. (The Engineer will decide which of the indications is to be treated as important).
- (d) The Video Wall Display Panel unit for Signalling system shall display the occupancy of various track sections along with the train description. Train ID box shall indicate different colours for different type of loads e.g. Container, Petroleum products, Food grains, coal etc. In case train number is not keyed-in, the same shall be shown as flashing unknown train identifier mark

- along with Non-Descript Alarm (NDA). Alarm will stop as soon as the train number is keyed in by the Controller /SM.
- (e) The Video Wall Display Panel for Signalling system shall also provide alarm indications of failure of points, signals, track sections etc. as the case may be.
 - (f) It shall be possible to show the temporary speed restriction fed by Traffic Controller/SM as Tag box or by any other means.
 - (g) Text in Video Wall Display Panel showing Signalling layout and status including Train ID shall be readable from seats of CHC, Dy CHC and Traffic Controller(s).
 - (h) Text in Video Wall Display Panel showing SCADA shall be readable from seats of CHC, Dy CHC and Traction Power Controller(s).
- (15) TMS Terminals for Chief Controller, Dy. Chief Controller, Traffic Controller(s) and Assistant Controller at OCC**
- (a) TMS terminals of Controllers shall have all the features available on Video Wall Display Panel and as mentioned in Para 3(14) (a) to (h) of this Appendix.
 - (b) The details of occupancy of berthing lines and sidings provided with track-vacancy detection system shall also be available on the terminal.
 - (c) TMS Terminal shall facilitate all functions of Train Describer System as mentioned in Clause 3(22) of this Appendix.
 - (d) All the Traffic related alarms described in Para 3(27) of this Appendix, shall be available on these terminals. It shall be possible to acknowledge and stop the audio alarm of failures. All displays shall be active and shall indicate Traffic Related Alarms.
 - (e) In case of unusual events and delays to trains, system will prompt the controller to enter the reason and other details in the prescribed format. This shall form part of database and shall be used for MIS reports later.
 - (f) The crew details available in the system shall also be available on these terminals, apart from being available on the TMS Terminals of Station Masters and Crew controllers.
 - (g) All user initiated functions shall be accessible using Mouse & Key Board. It shall be possible to enter commands through menus, selection in the pictures, functional keys or via text input through GUI based front end. The precise operation of objects and the content of menus must be as agreed with the Engineer.
 - (h) It shall be possible to scroll from left to right and vice versa from one station to another without flicker. In case of big yards with a number of lines, the yard shall not look congested on the screen and, therefore, predefined scrolling from top to bottom, left to right or vice versa shall be possible. In addition, it shall be possible to divide the bigger yards into suitable no. of pictures.
 - (i) There will be two monitors, of which one monitor will display the real-time status of train movement and trackside signalling while the other monitor will

display the Train Graph. There shall be full flexibility, however with regard to display of information on any of the 2 monitors.

- (j) It shall be possible to view Train Graphs be it historical, previous or current. The Train Graph shall also cover advance charting showing traffic blocks. Train Graph Lines/Train ID Box shall have tag with details of train, crew etc. These features have been further described in Para 3(23) of this Appendix.
- (k) Messages/Information of diversion/cancellation of trains issued from these Terminals will draw attention of SM by flashing audio visual indication.
- (l) It shall be possible to open many windows on each VDU. A window must be active when the cursor is moved in its frame and the operator must be able to issue commands only to those objects in active window. The display shall be dynamic even if the related window on the screen is not active.
- (m) The various input displays and reporting formats (to be decided in consultation with Engineer) shall be used for dialogue between the operator and the terminal.
- (n) The controller shall be able to enter any inputs regarding rescheduling of trains. This data shall be considered temporary and the operator shall be prompted to input the duration for which the data shall be held valid.
- (o) The temporary valid data shall be given the same status as that of permanent data and all the time tables and trains graphs shall be generated as per this data.
- (p) It shall be possible to view various MIS reports.
- (q) It shall be possible to mute the audio or change the volume. It shall be possible to alter the viewing angle of the VDU monitor in the vertical and horizontal planes.
- (r) Current time and date shall be displayed on the VDU screen conspicuously.
- (s) The controller's display format shall be finalized in consultation with the Engineer.
- (t) Operator's Authority
 - (i) Authority to log in shall be protected through a password. Only authorized persons shall be able to log in and access related database.
 - (ii) Access to the server's application software & system software shall be restricted through the gateway and proper authority check.

(16) TMS Terminal for Signal Fault Controller at OCC

- (a) The Signal Fault controller shall be provided with workstation type terminals having capability of graphic display. All the features as available on the Video Wall Indication panel shall also be available on this terminal.
- (b) Remote monitoring of Status of Signalling equipment at stations and in Block Sections, including Power supply shall be provided. This shall include logging in of events in central system, generating alarms, alerts etc.
- (c) The terminal shall be able to display complete information of yards covered by TMS with details of Track sections, Signals, Points, LC gates etc.

- (d) Vacant/ occupied status of both Main and supervisory Track Vacancy Detection Systems shall be displayed side by side. While main track layout shall show status of main detection system, status of supervisory detection system may be shown by small strips by side of main track. The proposed arrangement shall be got approved by the Engineer.
- (e) Following status of each signalling sub system shall be available on the Signal fault controller's terminal:
 - (i) Serious Failure: Repair required immediately.
 - (ii) Minor Failure: Non interrupt failure with which train operation is not affected.
 - (iii) Normal status: Information that the equipment is working normally.
- (f) Any failure alarm of signalling system at any station shall be available in audio & visual form to draw attention of the fault controller. It shall be possible to acknowledge and stop the audio alarm of failures.
- (g) Real time display of train movements shall be available on the terminal with train details such as Train No., type of load, Loco Pilot etc.
- (h) Ordinarily it shall show complete yard at a time including all Track sectioned and Non-Track sectioned lines. Big yards can be divided into many parts, with provision of selecting any one part on a screen with facility of scrolling to see the full yard on one /more screens.
- (i) All Traffic related alarms described in Para 3(27) of this chapter shall be available on these terminals.
- (j) It shall be possible to gain access to all reports as can be accessed by the Section controller
- (k) It shall be possible to access the Applications server for retrieving reports in suitable format. All the formats for the displays /reports shall be decided in consultation with the Engineer.
- (l) It shall be possible to send message to the other controllers through the terminal by video flash /audio buzzer etc.
- (m) It shall be possible to see complete yards & block sections of full Bhaupur-Khurja section of EDFC.
- (n) All displays shall be active and shall indicate signalling /traffic /operator related alarms.
- (o) Facility of viewing the train graph on the same monitor shall be provided.

(17) TMS Terminals for Track Controller and Traction Power Controller at OCC

- (a) They shall input remarks / information pertaining to various unusual occurrences e.g. failures & delays to operation etc.
- (b) It shall be possible to gain access to all reports as can be accessed by the Traffic controller.
- (c) It shall be possible to access the Applications server for retrieving reports in suitable format. All the formats for the reports shall be decided in consultation with the Engineer. System will have a provision that a report retrieved by a particular controller pertains to him only.

- (d) It shall be possible to send message to the other controllers through his terminal by video flash /audio buzzer etc.

(18) TMS Maintenance Terminal at OCC

- (a) The maintainer's terminal shall be used for supervisory functions of the network and for observing any required nodes and their configuration at any time.
- (b) It shall be used for indication of all alarms, both operator related and network related.
- (c) It shall be possible to bypass any node if so required.
- (d) It shall be possible to configure terminals from this terminal.
- (e) It shall be used to provide fault logging & diagnostics for network equipment at element level.
- (f) Displays and printouts of equipment faults, communication failure occurring anywhere in the OCC or field network shall be readily available on this terminal.
- (g) In case of faults, this terminal shall provide all assistance for rapid detection of faults.
- (h) Alarms shall be available on this terminal to be treated as Critical Alarms & are as follows:
 - (i) Power supply failure at control centre, station, block section location or any node.
 - (ii) Central control internal communication failure.
 - (iii) Communication equipment failure.
 - (iv) Field control unit failure.
 - (v) Failure of nodes.
 - (vi) System failure.
 - (vii) Interlocking interface failure (Way Side Communication Equipment).
 - (viii) Any other indication considered essential.
- (i) Alarms shall be logged on real time basis. These shall be recorded in format so as to access particular file as required at a later date. Exception report (failure report of desired elements) shall be generated. File format shall be decided in consultation with the Engineer.
- (j) This terminal shall have access to MIS reports.
- (k) Terminal will provide a pop up window to display a table to allow maintainer to correlate data communication with its associated field objects. Also, online display about the following shall be available:
 - (i) Station being polled.
 - (ii) Station transmitting.
 - (iii) Station faulty.
- (l) Element level Network Management System (NMS) module shall be available on this terminal and shall show:

- (i) The position of various nodes.
- (ii) Identification of faults and their nature.
- (iii) Current status and health of equipment and communication channels.
- (iv) Memory utilization.
- (v) Remote bypassing and changeover of faulty equipment.
- (vi) Ability to check quality of communication from any node to the other on the network including bridges and routers. This shall be done in the background without visibly downgrading the system.
- (vii) Facility to view system / network performance statistics on this terminal.
- (m) Fault Diagnostics
 - (i) Any malfunction in vital hardware subsystem/ modules in the OCC will result in audio & visual alarm at the maintenance terminal.
 - (ii) The maintenance terminal shall have diagnostic software through which it will periodically scan all elements.
 - (iii) Diagnostic routine to check hardware like TMS field equipment (excluding interlocking installation) and data communication circuits shall be available.
 - (iv) Shall have monitor programs to test connectivity.
 - (v) It shall be possible to switch the transmission lines at all stations.
 - (vi) It shall be possible to display polling status of stations.
 - (vii) It shall be possible to capture all transmission events for analysis and fault finding of data transmission.
 - (viii) It shall be possible to change the password configuration of the Controllers /SMs terminals.
 - (ix) Network Management System
- (n) NMS facility shall be provided on maintenance terminal by which work station computers, terminal servers, voice and data switching nodes and SM terminals can be monitored at element level for performance and switching to back up paths can be carried out.
- (o) It shall be possible to monitor all elements of network of OCC and field units through NMS.
- (p) SNMP or standard protocol shall be used.
- (q) It shall contain real time LAN diagnostics.
- (r) Facility for Network performance statistics, communication testing and managing internal or external node on the network shall be made available.
- (s) There will be provision of a fault logging cum diagnostic terminal along with A3 colour Laser printer in the system. Displays and printouts of equipment faults or communication failure occurring anywhere in control centre equipment shall be readily available on this terminal. In case of faults, the maintainer terminal shall be able to provide all the assistance for rapid detection of faults.

(19) TMS Terminal for Station Master at Station

- (a) One TMS Terminal for Station Master at every Station shall be provided. All user initiated functions shall be accessible using Mouse & Key Board. It shall be possible to enter commands through menus, selection in the pictures, functional keys or via text input. The precise operation of objects and the content menus must be as agreed with the Engineer.
- (b) Real time display of train movements (including description) along with layout and status of signalling will be available on workstations as available on Section controller's terminals.
- (c) In case of big yards with a number of lines, the yard shall not look congested on the screen and, therefore, predefined scrolling from top to bottom, left to right or vice versa shall be possible. It shall be possible to scroll from left to right and vice versa without flicker. In addition, it shall be possible to divide the bigger yards into suitable no. of pictures.
- (d) TMS Terminal for Station Master shall facilitate all functions of Train Describer System as mentioned in Clause 3(22) of this Appendix.
- (e) It shall be possible to open many windows on each monitor. A window must be active when the cursor is moved in its frame and the SM must be able to issue commands only to those objects in active window. The display shall be dynamic even if the related window on the screen is not active. All displays shall be active and shall indicate traffic /operator related alarms.
- (f) It shall be possible to query the system regarding details of trains, cancellation, rescheduling, delays, diversions, siding occupancy etc. either through menu driven commands or through SQL commands. It shall be possible to query the Central Server in either formal menu driven commands or with simple parameter related command. It shall be possible to get information of train position from central server. On selection of this menu, user shall be asked to select/enter the train number. The system would then display train position, crew name, Load type etc.
- (g) The details of occupancy of berthing lines and sidings shall be available. Details of loads available on sidings at concerned station shall be displayed when cursor is placed on the siding. Whenever a train leaves / enters the control area or is put out of the system by placing it in the siding it shall be automatically registered by the system. In addition to this, SM shall have facility to delete / enter such trains. Whenever a train / load leaves /enters the control area of concerned station or is put out of the system by placing it in the siding the SM shall have facility to delete / enter such trains from / into the system.
- (h) Flashing messages/instructions from the controller and information about expected arrival of next two trains on each line, cancellation and diversion of trains shall be displayed.
- (i) The various input displays and reporting formats (to be decided in consultation with the Engineer) shall be used for dialogue between the operator and the terminal.
- (j) In case of unusual events and delays of trains, system will facilitate the SM to enter the reason and other details in the prescribed formats. This shall

form part of database and shall be used for MIS reports later. Alarm shall come along with format for entering the reason.

- (k) The temporary valid data shall be given the same status as that of permanent data and all the time tables and train graphs shall be generated as per this data.
- (l) It shall be possible to view various MIS reports.
- (m) It shall be possible to mute the audio or change the volume.
- (n) It shall be possible to alter the viewing angle of the VDU monitor in the vertical and horizontal planes.
- (o) Current time and date shall be displayed on the VDU screen conspicuously.
- (p) Communication arrangements available at the station shall also be displayed symbolically. It shall be possible to test connectivity to Field Interface Units.
- (q) It shall be possible to send messages to Central server. On selection of this menu, user shall be asked to select a pre-stored message, which shall then be sent to Central server. It shall also be possible to send any message, which is not pre-stored in SM terminal. On selection of this menu, user shall be prompted to enter his message in a dialogue window, which shall then be forwarded to Central server. It shall be possible to send message from TMS controller to SM TMS terminal. The system shall keep log of all the messages received from TMS.
- (r) The system shall be able to rename a train standing on the current system.
- (s) The station SM shall be able to interrogate the Central Server for any train related / siding occupancy queries.

(20) TMS Terminal for Signal Maintenance at Station, IMD and IMSD

- (a) Real time display of train movements (including description) along with layout and status of signalling shall be available on the terminal.
- (b) The alarms for failure of vital Signalling and Power Supply Equipment in the jurisdiction of Station, IMD and IMSD shall be available on the terminal.
- (c) Alarms shall be logged on real time basis. These shall be recorded in file format so as to access particular file as required at a later date. Exception report (failure report of desired elements) shall be generated. File format to be decided in consultation with the Engineer.

(21) Miscellaneous User Terminal

The Contractor shall provide 15 Nos. of Miscellaneous User TMS Terminals at important offices/locations. The locations shall include IR Junctions stations, IR Divisional and Zonal office and DFCCIL Regional & Corporate office etc. as decided by the Engineer. These terminals will provide first-hand information about running of trains in visual form and in required format. These terminals will be connected on Telecommunication System being provided under PS (Telecommunications) Vol. 4 Part 2 or any other network made available by the Employer.

(22) Train Describer System

- (a) The Train Management System shall include Train Describer System to associate a train with a unique alpha-numeric ID called a Train ID consisting of up to 8 alphanumeric characters displayed in a text box. This Train Describer System shall enable identification of all trains with Train ID as they move, and display real time information of their position and movements in sections monitored by TMS on Video Wall Display Panel and TMS Terminals.
- (b) Train Describer System shall facilitate dispatch of Train from TMS Terminal of Station Master. Options of Scheduled Dispatch and Special Dispatch shall be available. For Scheduled Dispatch, the window shall list pre-stored Train ID to be selected along with editable Scheduled Departure Time and Destination Station from Timetable stored in Central Server. For Special Dispatch it shall be possible to enter Train ID along with other information such as Destination Station, Type of Load, Crew Details etc. The scheme for the menu driven commands shall be drawn in consultation with the Engineer.
- (c) Train Describer System will generate an audio visual alarm NDA (Non-Descript Alarm) on SM's TMS Terminal as well as Traffic Controller's TMS Terminal in OCC, if Train ID has not been selected / entered by concerned Station Master.
- (d) Generally Train ID is to be assigned only when a train enters sections monitored by TMS for the first time. Thereafter Train ID and associated information can be modified, only if required, from TMS Terminals of Traffic Controller or Station Master
- (e) The Train Describer System shall register following abnormal conditions in the Central Database:
 - (i) Change in Direction of a Train.
 - (ii) Train Parting.
 - (iii) Unidentified Trains.
 - (iv) Trains passing a signal showing a Stop aspect.
 - (v) More than one train on the same Axle Counter Track section.
- (f) Abnormal disappearing of Train ID shall generate an alarm and display it in different colour.
- (g) The Train Describer System shall be able to handle the commands for:
 - (i) Insertion of a Train ID on a track or at a signal, which shall be assigned automatically to the train occupying the track.
 - (ii) Moving a Train ID to a different location.
 - (iii) Renaming a Train ID.
 - (iv) Exchanging one Train ID with another train describer tag.
 - (v) Deleting a Train ID.

- (h) It shall be possible to find the location of trains by search command. It shall also be possible to view list of trains in the Train Describer System with following criteria:
 - (i) All trains.
 - (ii) Only operator identified (known) train.
 - (iii) Trains in a given direction.
 - (iv) Trains at or between specific station(s).
 - (v) Unidentified or delayed or cancelled trains.
- (i) The Train Describer System shall send log records of the events logged including the following information to Central Database:
 - (i) Movement of trains (Axle Counter Track Section to Axle Counter Track Section with timing).
 - (ii) Operator's commands to the Train Describer System.
 - (iii) System will display crew details from the detailed link available in crew management software on query from various terminals of controllers & lobbies.

(23) Train Graph

- (a) The Train Management System shall also include Train Graph Function for plotting and display of Train Graph. These Train Graph shall be available at TMS Terminals provided with Chief Controller, Dy. Chief Controller and Traffic Controller(s).
- (b) It shall be possible to create, modify and delete Controlled Area included in Train Graph from individual TMS Terminals.
- (c) Train Graph shall plot Time on X-Axis and Stations on Y-Axis. It shall be possible to define and modify scales of X and/or Y coordinates from individual TMS Terminals.
- (d) It shall be possible to show Schedule Time and the Actual Time in the same graph but with different colours.
- (e) It shall be possible to define and modify colour allotted for various type of Train Loads.
- (f) On clicking/selecting a particular train on Train Graph, it shall give complete information about the train viz. Train ID, Crew Details, Load Details (e.g. Container, Petroleum Products, Food Grains, Coal etc.).
- (g) Advance Charting: In case Controller defines the Maintenance Block on particular line for particular time, Train Management System shall be able to prepare Projected Train Graph showing advance/predictive movements of available trains in particular section.
- (h) It shall be possible to deduce average speed of trains between any two stations.
- (i) It shall be possible to take train frequency reports from the time table data base.

- (j) The Train Management System shall be able to plot Historical Train Graph for selected period for analysis.

(24) Crew Management System (CMS)

- (a) The Crew Management System shall be provided for the management of crew running on Bhaupur-Khurja section of EDFC. Terminals of Crew Management System shall be provided at Crew Control Lobbies/Crew Booking points. In addition some functions of Crew Management System shall be available in TMS Terminals of Chief Controller, Dy. Chief Controller, Traffic Controller and Station Master.
- (b) Crew Management System will give real time position of Train Running Crew with details of Train and Location.
- (c) The Crew Management System shall have provision of creating database of Train Running Crew. The database will have all the information related to Personnel & Safety of all Train Running Crew.
- (d) Crew Management System shall have provision to generate Link Program based on data fed for Train Running Crew. It shall be possible to change Train Running Crew booking details for next 24 hrs. as shown in generated Link Program.
- (e) Crew Management System shall have provision to enter Train Running Crew Booking Details manually at Crew Control Lobby/Crew Booking Points for next 24 hours. Deviation for the booking schedules shall be entered by Crew controller on train to train basis. It shall also be possible to change the names of Train Running Crew, when prompted to do so by Central Server.
- (f) TMS shall automatically take the Train Running Crew details from the Link Program (with suitable tag that data is from link table) or the online data fed by Crew Controllers at Crew Control Lobby/ Crew Booking Points. TMS based on this information will show online position of Train Running Crew on Train Details Query on Controller's Terminals.
- (g) Getting daily report of planned booking and actual booking of Train Running Crew shall be possible. Generation of Monthly Reports of individual Train Running Crew in terms of daily KMs & Duty Hours shall be possible based on real time data from TMS. It shall also be possible to get query based details of Train Running Crew.
- (h) Crew Management System must be closely integrated with TMS to reap the benefits as indicated in paras above.
- (i) Crew Management System Screen shall be menu driven with multiple windows. The details of screen and procedure shall be decided in consultation with Engineer.

(25) Management Information System

- (a) The system shall generate report of trains running late by prescribed reference.
- (b) Based on the events logged and the operator input, the system shall generate following (but not limited to) reports:
 - (i) Punctuality report - daily, weekly or monthly as per prescribed format.
 - (ii) Bad runner report.

- (iii) Train Composition report.
 - (iv) Analytical report of various unusual occurrences, i.e. Signal failures, OHE breakdown, Loco failure, Sick wagons etc. This can be again generated on daily, weekly or monthly basis on prescribed format.
 - (v) Analytical report of crew link/ utilization.
 - (vi) Total Maintenance Blocks granted / refused along with locations, time blocked, time cleared.
 - (vii) Sectional running time taken by trains of any ID.
 - (viii) Delay report of trains along with train nos., time delayed (at stations/mid-section) etc.
 - (ix) Difference between actual and scheduled running time in tabulated as well as in graphical form.
 - (x) Loss on account of imposition of speed restrictions.
- (c) The system shall allow user to create an unusual report, describing a failure and the trains that were affected by it.
 - (d) The system shall allow user to enter any free text tag to be associated with any train.
 - (e) The reports shall be generated in designated formats.
 - (f) Report formats shall be amenable to customization.
 - (g) It shall be possible to print generated reports for which 2 nos. of networked A3 Laser colour printers shall be provided.

(26) Time Table Planning & Simulation System

- (a) A Simulation Server identical in hardware configuration to TMS Central Server shall be provided for Time Table Planning & Simulation System at OCC. This Simulation & Time Table Planning System shall also be used for training purpose. Information of Bhaupur-Khurja Section such as Inter Signal Distances, Permitted Speed of Trains, Signal Interlocking Details, Track Section Lengths etc. required for generation of Time Table shall be provided on Simulation Server.
- (b) The Time Table Planning System shall have facilities to Create/Edit/Delete a Train Service. A Train Service shall have attributes of Train ID, Type of Train Load, Stopping Pattern, Days of Run, Running Path, Dwelling Time, Length of Train etc. It shall be possible to use Train Service Template while creating a new train.
- (c) Based on above information, Time Table Planning System Software shall generate an Offline Working Time Table. It shall also give section wise Train Graph.
- (d) It shall be possible to modify/edit the generated Time Table. Time Table Planning System Software shall also have facility to find any Headway and/or Crossover conflicts in the modified/edited Time Table.
- (e) Printer(s) for taking colour prints of A3 size Working Time Table and A0 size Train Graph shall be separately provided with Time Table Planning & Simulation System.

- (f) It shall be possible to test generated/edited Time Table on Simulation System Software.
- (g) Time Table Planning & Simulation System shall be suitably integrated with TMS Central Server for transfer of this tested Time Table. This transfer shall be possible by authorized user only.
- (h) Through Simulation System Software, it shall be possible to simulate and observe the effect of various parameters such as Maintenance Block, Speed Restrictions, Change in Yard Layouts, Addition/Deletion of Signal, Train speed, Dwelling Time etc. on Section Capacity and to produce effected Working Time Table and Train Graphs. These parameters shall be decided in consultation with the Engineer.
- (i) Simulation System Software shall facilitate simulation of train movements by occupying & releasing Axle Counter Track Sections in accordance with movement of trains.
- (j) Time Table Planning & Simulation System shall be suitably integrated with TMS Central Server and its Database for downloading a copy of Events Logs & Alarms for predefined/selected duration in its own Database.
- (k) The simulation of downloaded Events Log & Alarms for replay shall be possible. This simulation shall be possible in real time or in reduced/accelerated time scale. When replay is started, the dynamic status for infrastructure, Train ID, Alarm List as well as the pictures on the screen shall be initialized. It shall be possible to perform studies on this simulation by changing various dynamic parameters such as Speed Limit on Signals, Temporary & Permanent speed Restrictions, Braking Characteristics, Driver's Reaction time etc.
- (l) The Simulation System Software shall be capable of simulating the existing Time Table and compare it with actual running on periodic basis to create Management Information to identify any shortcomings in the System/Time Table.
- (m) Time Table Planning & Simulation System shall also be used for imparting training through terminals provided to Trainer and Trainees. Details of facilities and features available on these terminals shall be decided in consultation with Engineer.
- (n) It shall be possible to configure Trainer's terminal to work as active Traffic Controller's TMS Terminal in case of any of the Traffic Controller's TMS terminal becomes defective/out of service.

(27) Event Log and Alarm System

- (a) All important events such as command, indications, errors, system information etc. shall be logged in a database for record and analysis. The Event Log should be automatically backed up by the system with a 60 day back up and that the active storage period is a rolling 30 days period.
- (b) Following Traffic Related Alarms shall be recorded and displayed on TMS Terminals of Traffic Controller, Signal Fault Controller and concerned Station Master:
 - (i) Failure of any Signalling Equipment including Electronic Interlocking, Power Supply, Axle Counter, Signal Lamp, Point Machine etc. in the

- entire section under scope.
- (ii) Routes not released after passage of train.
 - (iii) Train passing Signal at Danger (SPAD).
 - (iv) Train Non-Descript Alarm (NDA).
 - (v) Train waiting for more than 5 minutes at a manual stop signal not taken off.
 - (vi) Train stopping at OFF signal for more than 5 minutes.
 - (vii) Any other unscheduled train stoppage.
 - (viii) Any unscheduled train detention in excess of prescribed time.
- (c) All the above Traffic Related Alarms shall be arranged in priority levels to be decided in consultation with the Engineer.
 - (d) It shall be possible to prepare Traffic Related Alarms Reports in formats to be decided in consultation with the Engineer.
 - (e) All alarms not directly related to traffic operations shall be considered to be Network related alarms. Failure of Network Communication / inability to access any of the TMS nodes, defective terminals and hardware & software failures shall initiate Network related alarms.
 - (f) These Network Related Alarms shall be displayed on the TMS Maintenance Terminal in OCC. These shall be arranged in priority levels to be decided in consultation with the Engineer.

(28) Software Features

- (a) As all data may not be available in a satisfactory format during the initial implementation of the system, it is necessary that provision exists for incorporating changes/amendments to the existing formats/presentation and for introduction of new functionality. It is also possible that additional items/objects may have to be introduced in future, hence provision should exist for incorporating them.
- (b) Menu driven Customization tools shall be made available to cater for changes in yard layout and to carry out the required changes in databases and graphic display of altered layout. To ensure that alterations /amendments are carried out as intended, the terminal operator shall confirm the amendments before inputting to system or saving on system. System shall prompt confirmation request with authority. All amendments shall be recorded with the authority.
- (c) Modification and Alteration
 - (i) It shall be possible to add minor additional functionality (to be decided in consultation with the Engineer) or even extend the system to more number of users by adding extra workstations without changing existing software.
 - (ii) Following modifications shall be possible with password authentication without recourse to the source program (code).
 - Managing the Users

- Ability to add users specifying their names, password & access level.
- Facility to delete an existing user.
- Change the priorities allocated to users.
- Stop / provide access to any of the modules.
- Change areas of jurisdiction.
- Database Management
 - Database administration.
 - Edit database to change the names of locations, stations etc.
 - Change status of stations.
 - Introduce new stations.
 - Introduce new objects and delete existing objects.
 - Change details of objects.
 - Amend / alter geographical layout at stations and in between stations.
 - Change format of reports.
 - Introduce new reports.
 - Introduce/change/delete temporary speed restrictions.
- Time Table Management
 - Cancel a train.
 - Insert an additional train.
 - Change the destination of a train.
 - Change the departure time of a train.
 - Change the timetabled dwell time at any station for one train or all trains.
 - Change timings of existing trains.
 - Change the sequences of trains.
 - Change various particulars of trains.
 - Change the loco number vis-à-vis train number.
- System Management
 - Change priorities of existing alarms.
 - Introduce new alarms with varying priorities.
 - Changing the details of any node.
 - Introduction of new nodes.
 - Changing the displays on maintainer's terminal.

- Changing the printer / plotter parameters.

(29) Interface between TMS and SCADA system

Interfacing with the OHE SCADA system shall be provided to achieve following information exchanges between TMS & SCADA:

- (a) TMS will take OHE shut down reports from OHE SCADA system.
- (b) TMS will take details of the various power block granted and their duration from SCADA system.
- (c) TMS will take details of OHE failures and tripping details of FP, SP, and SSP.
- (d) SCADA will pick up train ID details from Train Describer system of TMS.
- (e) SCADA will pick up failure of AT supply details from TMS to organize restoration of failed AT supply.
- (f) Any other information considered necessary by the Engineer.

(30) Interface with Master Clock System

The system clock shall be synchronized with Master clock provided in OCC under PS - Telecommunications Works, Vol. 4, Part 2. In case of failure of Master clock, TMS clock shall keep on working based on last synchronized time.

(31) Interface with FOIS and other applications

TMS shall provide Train Identification along with train arrival and departure time for FOIS and other applications.

(32) Interface with others TMS

- (a) The TMS provided under this contract shall be designed to interface with TMS of other vendors to be provided in other sections of EDFC and TMS to be provided in back-up OCC.
- (b) The Central Server provided under this contract shall interface with Central servers of adjacent sections for seamless exchange of information, including but not limited to the following:
 - (i) Train schedule information: Daily/seasonal Time table etc.
 - (ii) Train running information: Train identification, type, composition, crew details, dynamic location etc.
 - (iii) Train approaching the boundary of adjacent section.
 - (iv) Special events: Unusual delays, Loco fault, any unusual alarms etc.
 - (v) Any other information as required during the execution of the contract.
- (c) The format of data exchange should be non-proprietary and vendor independent/open type such as XML, CSV, text strings etc. The protocol used for interface shall be industry standard open protocol, which shall be easily configurable such as Modbus TCP, Webserver etc. It shall be possible to establish/configure logical link between server/systems of adjacent TMS. The communication protocol used for TMS-TMS interface

shall be TCP/IP based and data routing shall be possible by IP configuration.

- (d) The contractor shall prepare an Interface specification detailing the information required to be shared between the TMS provided by him and the TMS to be provided by other contractors in EDFC. The contractor shall share all the required information of his TMS, including the data formats, protocols, physical/logical connectivity and limitations related to the interface, with the Employer/Other contractors, to enable them design their interface. Similarly, the contractor shall obtain all the required information from TMS providers of other sections of EDFC and design its interface accordingly.
- (e) The Timetable and Crew Management system provided under the contract shall also be used by TMS of other sections of EDFC. This data shall cover all the sections of EDFC and will be kept only in the Central server(s) provided under this contract. Not only that the Timetable and Crew Management information be transmitted by Central server provided under the contract to Server(s) of other TMS, but also any update carried out to it by other TMS shall be replicated into the Central server(s) of this contract, for further distribution to all other TMS.

(33) SYSTEM ADMINISTRATION

- (a) A supervisor administration function to be exercised by a single nominated person shall, as a minimum, be available to control the following:
 - (i) Allocation of Passwords.
 - (ii) Creation and deletion of Users.
 - (iii) Administration and housekeeping functions.
- (b) The functions of Supervisor Administration will eventually rest with the Chief Controller, when the TMS is fully implemented for control and monitoring.

4. TECHNICAL REQUIREMENTS

(1) System Architecture

- (a) System shall have highly scalable architecture. It shall be possible to increase/reduce the number of monitored equipment flexibly.
- (b) There shall be redundancy in Servers with Main and Standby configuration. Both Main and Standby Servers will be normally ON and updated with latest data/status.
- (c) It shall be possible to achieve load changeover manually from Main to Standby systems (Servers) and vice versa.

(2) General

- (a) All servers and terminals to be provided at OCC shall be of same type and make as approved by the Engineer.
- (b) All terminals to be provided at wayside locations shall be of same type and make as approved by the Engineer. The hardware installed at wayside locations shall be modular and rugged.

- (c) All Servers and terminals at OCC & wayside locations shall be provided with printer slot and minimum 2 spare I/O slots for future use.
- (d) Servers and Terminals shall be of Industrial grade. Vendor of Servers and Terminals shall have service centres in India.
- (e) LED Indications and test points shall be available on various cards /Modules for easy fault diagnostics by the maintenance personnel.
- (f) Field station hardware shall be housed in a 19" dust free, pre-wired rack. It shall be on Modular Computing Platform using 30 micron gold plating on slot connectors, Keyboards protected with protective membrane to avoid dust ingress.
- (g) All updated components shall be fully backward compatible with the originally installed components.
- (h) The Contractor shall notify the Employer in writing prior to deleting any component of the system from general availability and submit written assurances that it can provide functionally identical replacement units. The notification period for the deletion of the component and written assurances shall not be less than the lead-time for ordering or manufacturing the component plus six months.
- (i) The system designed and implemented shall be flexible and modular enough to permit easy alterations/changes in terms of change in site data, addition or deletion of user, stations etc. and for easy reconfiguration to take into account future software/hardware developments.
- (j) The communication protocols and hardware standards shall follow standard protocols. The software used for TMS shall conform to UIC or any similar standards.
- (k) The system shall be fault tolerant and shall continue to operate properly in the event of failure of some of its parts. This shall be built in as part of software and hardware at both OCC and at the wayside locations. Fault tolerance can be achieved by anticipating exceptional conditions and building the system to cope with them and in general, aiming for self-stabilization so that the system converges towards an error free stage.
- (l) The TMS system is intended to be used in 24/7 mode. Hence built in features/strategies should ensure that the system is available on a continuous basis. Particular care in system design shall be taken for those components that have a tendency to fail on continuous use or whose life is short.

(3) TMS Central Server

- (a) The following shall be the main functions of the applications server:
 - (i) It shall maintain and update in real time the position of all the TMS indications /information / all field nodes to the last second.
 - (ii) It shall provide drive for the Video Wall Display Panel. It shall screen all the incoming information /data and shall revert back to the field nodes for incomplete information and obtain it in the background.

- (iii) It shall accept input data from the authorized operator /node only. The access to the server shall be through a gateway with proper level of authority. It shall process the data as per requirements of the system.
 - (iv) It shall reply to the queries requested by various SMs in the background without interrupting the section controllers.
 - (v) It shall provide necessary data to print the various reports in suitable formats.
 - (vi) It shall enable display of both information and alarms on any of the terminals in OCC, Station etc. as per pre-programming.
 - (vii) It shall be possible to store at least 30 days TMS data on the main hard disc.
 - (viii) It shall be connected via data channels with all the station signal interlocking through a suitable interface. The OFC/data channels for connectivity will be provided by the Telecommunication system under PS (Telecommunications) Vol. 4 Part 2.
 - (ix) The aggregate information/ status of Track sections, signals, points, route set, LC gate closed/open etc. of station and block section shall be transmitted from wayside stations to applications server.
 - (x) The Contractor can suggest his own networking methods between field stations and Central server to achieve desired performance. All network elements shall be of managed type.
 - (xi) It shall be provided with adequate flexibility so that alterations and additions in the present functions and facilities are carried out with minimum disruption in the working system as and when required. It shall be compatible with future interlocking changes/yard alterations at wayside stations.
 - (xii) It shall be compatible for running off line forecasting module for computing expected arrival of trains.
 - (xiii) Applications server equipment shall be fault tolerant system. It shall also be provided with Disc storage device to store real time database reflecting TMS information as well as an event logging database. Various terminal / equipment in the OCC office shall be interconnected with applications server using a dual local area network (LAN). Adequate redundancy of critical system, software and database shall be ensured.
 - (xiv) Any other work to be done by applications server so as to obtain integrated system.
- (b) Applications server is the main system processor of the TMS for controlling and supervision. It shall have following minimum hardware configuration:
- (i) Type: High end server.
 - (ii) Processor – Minimum 64 Bit, Multi Core Multi-processor.
 - (iii) Speed - Minimum 2 GHz.
 - (iv) N+1 Hot swap cooling.
 - (v) PCI-X 8/16 port.

- (vi) Core PCI-X dual port 10/100/1000Base TX LAN (with auto speed sensing; RJ 45 connector, Wake On LAN support).
 - (vii) HDD - Minimum 8X146 GB, Hot swappable, Ultra SCSI with appropriate RAID configuration support.
 - (viii) Console - 24" colour monitor.
 - (ix) Hot swappable redundant power supply.
 - (x) I/O card - Adequate I/O facility.
 - (xi) Accessories - As required.
 - (xii) Supporting operating system – 64 bit
 - (xiii) Server shall be mountable on 19" rack.
 - (xiv) Three Years warranty (from OEM)
- (c) Central Server shall be provided in hot standby mode. The Standby server shall be exact replica of Main Server. In the event of problem with main server, execution of application shall be seamlessly transferred to standby server without interrupting the operation and affecting the quality of service of operation. Similarly, if system is running on standby server and it fails, working shall be transferred to main server. Central Server shall be capable enough to deliver the required performance. It shall be possible to disconnect the now standby server for repair/replacement without affecting the server in operation. The contractor may supply more than one equipment/set of equipment to achieve the required performance along with its hot standby.
- (d) **Logging of Data on Servers**
- (i) Following data need to be archived for subsequent use:
 - All train related information. (Signalling indications, train movements details, trains description details etc.)
 - All system related data viz. node failures, hardware failures, communication failures etc.
 - All inputs made by the way side terminals (inclusive of crew lobby/crew booking point) or by terminals at the OCC.
 - (ii) The data shall be stored in a compressed and organized form so as to conserve the disc space.
 - (iii) The storage shall be for a minimum period of 30 days.
 - (iv) It shall be possible to take INCREMENTAL back up on hard disc. The Contractor shall provide additional hardware for this purpose.
 - (v) It shall be ensured that the data is not lost while copying.
 - (vi) The notes recorded by the Section controllers/SMs shall also be logged. These notes shall be linked to the concerned screen and context.
- (e) The number of Servers and their configuration should be proposed by the Contractor. The Contractor must present RAMS analysis in order to

demonstrate that the proposed solution satisfy the availability requirements.

(4) Simulation Server

These shall be provided as standalone with its own LAN at the OCC or any other location as decided by Employer for Time Table Planning, training and simulation purposes as per following (but not limited to) details:

- (a) It shall have the identical configuration to TMS Central Server and facilities as of Central Server. It shall be equipped with the following:
 - (i) One terminal with 3X24" (minimum) VDUs for Simulation and Time Table Planning.
 - (ii) Five terminals for Trainees with 1X24" VDU (minimum).
 - (iii) HDD - Minimum 2 X 64 GB, Hot swappable, Ultra SCSI in RAID 1.
- (b) It shall be possible to configure Trainer's terminal to work as active Section controller's terminal in case of any of the Controller's terminal becomes defective/ out of service or any other reason.
- (c) It shall be possible to access the database for analysis and simulation studies. The data or results thus generated after simulation study or analysis shall not be stored on the main memory of the Applications server permanently. To prevent the same, both hardware and software checks shall be provided. It shall be possible to store it in its own hard disc.

(5) TMS Terminals of Chief Controller/Dy. Chief Controller/Assistant Controller/Traffic Controller(s) at OCC and TMS Maintenance Terminal at OCC

- (a) These TMS Terminals shall have the following minimum Hardware Configuration:
 - (i) Type: Industrial Workstation.
 - (ii) Processor: 64 Bit Intel® Xeon® Six-Core Processor 3.20 GHz or better.
 - (iii) RAM: Minimum 8 GB.
 - (iv) FLASH MEMORY: Minimum 120 GB
 - (v) Monitor: LED Backlit Colour monitor, high resolution 1920 X1200, 2 nos. of 32" (minimum).
 - (vi) I/O card: Adequate I/O facility, Integrated Drive Controllers, Dual network Interface cards, High End Graphics card etc.
 - (vii) Accessories: As required, if any.
- (b) A printer shall be connected for on line logging with the TMS Maintenance Terminal for logging all network related alarms.

(6) TMS Terminal for Signal Fault Controller, Track Controller, Traction Power Controller, Miscellaneous TMS Terminals

Hardware Configuration of these TMS Terminals will be identical as that of Traffic Controller's TMS Terminal except that there will be only one Colour monitor of 24" size.

(7) Communication Network at OCC

- (a) Dedicated Communication Network at OCC for interconnection of TMS Equipment (Servers, Terminals, Video Wall Systems, Data Storage, Printers etc.) shall be fault tolerant.
- (b) Networking Equipment used in Communication Network such as Bridges, Gateways, Routers, Switches and Repeaters shall be redundant.
- (c) The local area network employed shall be Dual LAN Network based on FDDI/Ethernet/Serial communication.
- (d) Dual redundant link shall provide highly resilient communications network. System shall be tolerant to multiple simultaneous link failures, maintaining operation without degradation of performance. It shall be possible to perform maintenance on communication links without stopping the signalling system.
- (e) Data transfer to peripherals like printers & plotters can be at lower speed for each device using appropriate media with duplicate path.
- (f) For connecting peripherals, screened twisted pair cables shall be used.
- (g) The hubs/switches/network components shall be dual. The connecting cables shall also be dual.
- (h) The cables used shall be of rugged type with capability to work data up to at least 100 Mbps.
- (i) 30 % spare Ports on Switches & Hubs etc. shall be kept spare for future use.
- (j) Redundant Hot Standby Communication Server shall be provided for meeting communication requirements with Wayside Communication Equipment, TMS of adjacent sections of DFCCIL, TMS Equipment at Backup OCC.
- (k) Communication Server shall provide full support for the entire communication protocol conversion. It shall have adequate storage for buffering to inputs from LAN and for sending data.
- (l) Communication Server shall provide communication with TMS of adjacent DFC, TMS Equipment at Backup OCC through an active Firewall for protection of TMS from Viruses.
- (m) Failure of any single Wayside Communication Equipment shall not cause failure of complete communication of TMS other than that of particular Wayside Communication Equipment.
- (n) It shall be possible to interface and transfer the circuits on to the backup communication on redundant path of OFC, wherever available. The communication processor shall be capable of providing patch up facility.
- (o) All equipment shall be installed in standard 19" racks.
- (p) The time slots working shall have redundancy. However, it shall be possible to transfer all data from one time slot to a redundant time slot, if required.
- (q) The transmission with field stations shall be controlled by the OCC equipment by polling wherever transmission is in serial mode and not in star configuration.

- (r) In-built safety provisions shall be available to detect data corruption/ non-receipt of packets/node defect problems.
- (s) It shall be possible to bypass any station without interrupting the routine working.

(8) Video Wall Display System

(a) General Description

- (i) Display shall be of rear projection type based on single chip DLP Technology. It will consist of Display modules and Display Controller which will integrate various Display modules into a single logical Display Wall.
- (ii) The wall display shall be made up of individual Rear View projection Display modules which shall be integrated to form a single video wall using Display Control Manager workstation and Video Wall Management Software.
- (iii) It shall be rugged and of industrial standard and shall be able to work on 24x7 basis.
- (iv) The display windows shall be freely resizable, re-scalable and repositionable on any part of the display wall.
- (v) Details of Live indications display on Video Wall is given in Para 3(14).
- (vi) Station codes, signals, tracks, train description etc. shall be displayed. The field objects shall be as per geographical layout. For trains, however, the train IDs only may be displayed.
- (vii) Sufficient space shall be made available between the track indications for alphanumeric displays.
- (viii) Suitable Interface equipment and drivers for linking Indication panel with applications server shall be provided.
- (ix) The terminal server /driver for driving the Video Wall Display Panel shall have full-fledged capacity to drive described displays from provided equipment + 20% spare.
- (x) The Video Wall Display Panel shall be vertical and placed in an arc shape mode so that all the parts of the panel are seen clearly with ease without strain when seen by the Controllers from their farthest seats.
- (xi) Legibility, lighting, contrast, content, font size, viewing distance etc. shall be kept in view while designing graphics for the display.
- (xii) Surface shall have matt finish to keep it glare free.
- (xiii) Glass backing shall be used so that there is no screen build bulge in.
- (xiv) Station layouts can be arranged in a number of rows– top, middle and bottom.
- (xv) The lowest row shall not be below 1.5 meters (approx.) from the floor to ensure proper viewing angle. This shall be got agreed by the Engineer.

- (xvi) Pedestal shall be made of Aluminum extruded and anodized members.
- (xvii) Front of the pedestal shall be covered.
- (xviii) It shall be compatible with the international VIDEO Standards.
- (xix) It shall have high MTBF and low MTTR. Values of the same shall be given with supporting calculations/data.
- (xx) Rear Projection System shall have rear service access.
- (xxi) Projection system will have cooling fan with dust filter.
- (xxii) It shall be possible to increase/decrease the colour intensity, contrast adjusting etc. screen wise through the system console. It shall be possible to memorize the parameters of one screen and use the same parameters for all the other screens.
- (xxiii) The unit shall be compact and energy efficient so as to conserve on space and power consumption.
- (xxiv) The projector support software packages, documentation and details of maintenance shall also be supplied.
- (xxv) All kits required for achieving the above shall form an integral part of the system.
- (xxvi) Any other facility to make the system more user friendly shall be incorporated.
- (xxvii) Indigenous service support shall be available for the chosen make.

(b) Minimum technical Requirements of Display Wall

Item	Specification
Projection Technology	Display Unit/Rear Projection Module must be based on Single Chip Digital Light Processing (DLP) based Rear Projection Technology.
Architecture	The display unit/rear projection modules shall have in-built illumination system.
Display size	The diagonal size of each visual display unit/rear projection module shall be minimum 70 inches (Diagonal) - to be got agreed by the Engineer.
Resolution	Each individual cube minimum Full HD (1920x1080 pixels)
Aspect Ratio	16:10 or 16:9
Lamp type	LED - RGB
Display redundancy	The Display Unit/Rear Projection Modules should have in-built redundancy in LEDs for each color and ensure redundancy at the light source level without any mechanical movement. Error shall also be shown by Diagnostic LED indicators in case of LED lamp failure.
Cooling Mechanism	Cooling shall be by means of heat pipe. No pump based mechanism is acceptable due to possibility of failure.

Item	Specification
Brightness	Shall be minimum 220cd/ m2 or higher.
Brightness Uniformity	≥ 95%. To automatically provide brightness and color stability over time and across the entire display.
Contrast ratio (Full field)	≥ 1400:1
Colour gamut	Better than 100% EBU
Screen	Burn free. No memory and no ghosting. No constant flicker. Low reflection with matt finish.
Screen type	Fresnel/ Lenticular
Screen to screen gap	Shall be adjustable up to 1.0 mm or less for seamless viewing.
Viewing Angle	Full viewing angle shall be 180 degrees.
Pedestals	Shall be customized as per project requirements.
Component input Compatibility	480i, 480P, 720P, 1080i
Auto detection	System shall automatically search the source which has input signal after signal plug-in.
Source Redundancy	System shall be able to switch to secondary DVI input if primary DVI input is not available. System shall also automatically switch back to primary DVI from secondary DVI input as soon as primary DVI input becomes available again.
Power control	1AC power ON/OFF switch.
LED indicator	Power LED (Standby: Red, ON: Green, Fan led, Lamp LED.
IP /Remote Control	User should be able to control and monitor each Projection module through Internet / Intranet.
Component Life- LEDs	>60,000 Hours
LED Control	Dynamic control
Startup	Instant hot restart
Component life - DMD Panel	Shall be greater than 650,000 hours

(c) Display Controller

- (i) The Display Controller shall be in an industrial 19" rack mounted casing (6U) based on Intel Quad Core CPU 2.66 GHz (Min.)
- (ii) The Display controller shall have min. memory of 4 GB (standard).
- (iii) The Display controller unit shall be equipped with a DVD ROM Drive.
- (iv) The Display controller system shall be equipped with 250 GB HDD in RAID 1 Configuration.

- (v) The display controller shall be dual redundant with auto switchover including dual redundant hot swappable power supply.
- (vi) The Display controller shall have 10/100/1000 Mbps Redundant Ethernet port for LAN connection.
- (vii) The Display controller shall be supplied with a Keyboard and mouse with 20 m cable extension.
- (viii) The Display Controller shall be based on WINDOWS Operating system.
- (ix) The Display controller shall have the possibility of connecting the various type of analog and digital sources which can be shown in freely scalable and moveable windows on the graphics wall. It shall support 2 DVI/VGA/HDMI Inputs and 8 Composite video inputs.

(d) Wall Management Software

- (i) It shall be able to pre configure various display layouts and access them at any time with a simple mouse click or based on the timer.
- (ii) The software shall enable the users to see the desktop of the graphics display wall remotely on any Windows OS workstation connected with the Display Controller over the Ethernet and change the size and position of the various windows being shown.
- (iii) The software shall enable various operators to access the display wall from the local keyboard and mouse of their Windows OS workstation connected with the Display Controller on the Ethernet.
- (iv) The software shall copy the screen content of the Windows OS workstation connected on the Ethernet with the Display Controller to be shown on the Display wall in scalable and moveable windows in real time environment.
- (v) The wall management software shall support open APIs to enable system integrators to integrate it with their Software.
- (vi) The Diagnostic software shall perform health monitoring that allows timely detection of faults.
 - Wall health.
 - Cube health.
 - Cube IP-address.
 - Brightness.
- (vii) Diagnostic Software shall allow commands on wall level or cube level or a selection of cubes :
 - Switching the entire display wall on or off.
 - Setting all projection modules to a common brightness target, which can be either static (fixed) or dynamic to always achieve maximum (or minimum) common brightness between projection modules.
 - Fine tune color of each cube

(viii) The integrated view shall provide a database that:

- Records all events.
- Can record full status at given time intervals.
- Can be exported to excel/html and
- Show internal patterns.

(9) Wayside Communication Equipment

- (a) Wayside Communication equipment at Electronic Interlocking shall be provided with redundancy for meeting communication requirements between Wayside electronic Interlocking and Communication Server at OCC. It shall provide interface with the required Potential Free Contacts in Signal Equipment Room, if required.
- (b) These units shall be installed in Signal Equipment room in a stand-alone mode. 20 % of the slots used for fixing I/O and peripheral cards shall be kept spare for future expansion.

(10) TMS Terminal for Station Master at Station

TMS Terminal for Station Master at Stations shall have identical configuration as that of TMS Terminal of Traffic Controller.

(11) TMS Terminals for Crew Controller, Signal Maintenance at Station, IMD and IMSD

Signal Maintenance Terminal at Station, IMD and IMSD shall have identical configuration as that of TMS Terminal of Signal Fault Controller in OCC.

(12) Software

(a) General

- (i) All functional requirements as described in Para 3(28) of this Appendix, shall be referred while designing software.
- (ii) The Software shall be designed, developed and tested according to the Software Quality Assurance Plan. The Contractor shall define within the Software Quality Assurance Plan what techniques and measured are applied for software development.
- (iii) All software shall be based on open system concept, shall be modular and independent of type of processor or hardware platform.
- (iv) It shall be based on co-operative or client server processing architecture with distributed processing logic.
- (v) The Software shall be developed on 64 bit UNIX/Windows or Multitasking Platform. All software shall be portable across similar operating systems.
- (vi) The Software shall be developed using ORACLE/SQL/DB2 Database Management System (DBMS). The real time DBMS shall keep at least two synchronized copies of all data bases to enable quick switch over to standby processes without loss of data (RAID-1 System). To achieve hardware tolerance at the main server, the Disc Controllers used for RAID systems shall be separate.
- (vii) The database shall be stored in file structure for easy retrieval of the selected data. It shall be possible to access the same file by more

than two users at the same time and information on such a file shall be active.

- (viii) It shall be possible to query the database either through format driven commands or by simple parameter related commands. These shall be drawn in consultation with the Engineer.
- (ix) The procedures for maintenance of the security of the system software shall be defined considering Sabotage, Unauthorized Access, Virus etc. Suitable protection against VIRUS shall be provided. Any bug found in the software during or after DNP shall be eliminated free of cost.

5. TMS DOCUMENTATION

- (1) The manufacturer shall supply, but not limited to following sets of documents for TMS:
 - (a) User manual: This Manual is meant for users of TMS explaining basic operation of data entry, data recording, generation of reports etc.
 - (b) Operator manual: This manual is meant for System operator, who manages the system, controls individual operators, generates authorization, and supervises the functioning of system.
 - (c) Programming manual: This manual is meant for Technical staff and will be used for programming the changes in display, incorporating changes in name of station, yard layout change, adding and deletion of new station, addition and deletion of new controllers etc.
 - (d) Service/trouble shooting Manual: This manual is meant for technical staff and will be used to attend the various failures and troubleshoot the fault. The manual shall guide step by step to arrive at the exact fault.
 - (e) Maintenance cum Technical manual: This manual is meant for technical staff and guides step by step for carrying out the various periodical & preventive maintenance checks and backups to be taken to prevent loss of data/software.
 - (f) Schematic installation drawings: These drawings indicate the various arrangements of TMS like various controller terminals, its layout, inter connections of the terminals, arrangement of LAN, configuration of equipment, the equipment installed at various locations etc.
 - (g) Installation, operation & maintenance manuals: These shall be supplied as per details given in GS/PS.
- (2) Software documentation
 - (a) Detailed documentation of application software shall be supplied. The software code details of Modules explicitly developed for DFCCIL shall be supplied along with full documentation. Details of each module shall be explained.
 - (b) All standard software supplied shall be licensed versions in the name of "DFCCIL" along with original latest documentation.

(End of Appendix 7)



**BID DOCUMENT
FOR**

DESIGN, SUPPLY, CONSTRUCTION, INSTALLATION, TESTING AND COMMISSIONING OF 2X25KV AC ELECTRIFICATION, SIGNALLING & TELECOMMUNICATION, E&M AND ASSOCIATED WORKS ON DESIGN-BUILD LUMP SUM BASIS FOR DADRI-KHURJA SECTION (APPROXIMATELY 47 ROUTE KM OF DOUBLE LINE) OF EASTERN DEDICATED FREIGHT CORRIDOR

SYSTEMS WORKS CONTRACT PACKAGE 105

Issued on: 14.06.2017

ICB No.: HQ/SYS/EC/D-B/Dadri– Khurja

EMPLOYER'S REQUIREMENTS

PART-2, SECTION-VI,

VOLUME-4

PARTICULAR SPECIFICATIONS: TELECOMMUNICATION WORKS

**EMPLOYER: DEDICATED FREIGHT CORRIDOR CORPORATION OF INDIA LTD
(A GOVERNMENT OF INDIA ENTERPRISE)**

MINISTRY OF RAILWAYS

COUNTRY: INDIA

TABLE OF CONTENTS

PART 1 – Bidding Procedures

- Section I. Instructions to Bidders
- Section II. Bid Data Sheet
- Section III. Evaluation and Qualification Criteria (Following Prequalification)
- Section IV. Bidding Forms
- Section V. Eligible countries

PART - 2 – Employer's Requirements

Section VI. Employer's Requirements

- Section VI. Employer's Requirements
- Volume 1: General Specifications
- Volume 2: Particular Specifications – 2x25 kV, AC Traction Electrification and Associated Works
- Volume 3: Particular Specifications – Signalling Works
- Volume 4: Particular Specifications – Telecommunication Works**
- Volume 5: Particular Specifications – E&M and Associated Works

PART 3 – Conditions of Contract and Contract Forms

- Section VII. General Conditions (GC) As per FIDIC Yellow Book 1999-Edition
- Section VIII. Particular Conditions
 - *Appendix to Tender*
- Section IX. Contract Forms

PART 4 – Reference Documents

1. Alignment Plans, Yard Plans and Building Plans
2. Power Supply, Distribution, OHE and SCADA system Schemes & layouts and S&T Drawings
3. DFCC-Environmental Assessment Report for Khurja - Dadri Section
4. Environmental Management Framework(EMF) for EDFC
5. DFCC– Resettlement Action Plan for Khurja- Dadri Section
6. DFCC-SHE Manual
7. Specification for 12000hp locomotive and Tractive effort Curve
8. IR's Transmission line Network and DFCCIL's Traction Sub Station (TSS) Connectivity

PARTICULAR SPECIFICATIONS: TELECOMMUNICATION WORKS

Table of Contents

CHAPTER 1 - INTRODUCTION	6
1.1 General.....	6
1.2 Purpose.....	6
1.3 Scope of Work	6
1.4 Relevant Documents	7
1.5 Infringement of Patent Rights.....	7
CHAPTER 2 – ABBREVIATIONS & STANDARDS	9
2.1 Abbreviations	9
2.2 List of standards/Specifications	13
CHAPTER 3 - PERFORMANCE REQUIREMENTS.....	16
3.1 General.....	16
3.2 Reliability Requirements	16
3.3 Availability Requirements	16
3.4 Maintainability Requirements	17
3.5 System Safety Requirements.....	17
3.6 Electromagnetic Compatibility (EMC).....	18
CHAPTER 4 - DESIGN REQUIREMENTS.....	20
4.1 Design Approach.....	20
4.2 Design Review	21
4.3 Man Machine Interface Design.....	22
4.4 Submission of Samples	22
4.5 Equipment Design	22
4.6 Environmental Conditions	22
CHAPTER 5 - OPTICAL FIBRE COMMUNICATION SYSTEM REQUIREMENTS.....	24
5.1 General.....	24
5.2 Scope of Supply for OFC System	24
5.3 System Requirements	24
5.4 Performance Specification.....	31
5.5 Technical Requirements	32
CHAPTER 6 - DATA NETWORKING SYSTEM.....	36
6.1 General.....	36
6.2 Scope of Supply for Data Networking System	37
6.3 System Requirements	37
6.4 Performance Requirement	38
6.5 Technical Requirements	39

6.6	Security.....	41
6.7	Network Resilience and Protection.....	41
6.8	Network Management System	41
6.9	Structured Cabling	42
6.10	System Expansion.....	42
CHAPTER 7 - TELEPHONE SYSTEM		43
7.1	General.....	43
7.2	Scope of Supply	43
7.3	System Requirement	43
7.4	Performance Specification.....	51
7.5	Technical Requirement	52
CHAPTER 8 - MOBILE TRAIN RADIO COMMUNICATION SYSTEM.....		58
8.1	General.....	58
8.2	Scope of Work	58
8.3	Functional Requirement.....	59
8.4	Performance Requirements	68
8.5	Technical Requirements	69
8.6	System Expansion.....	76
CHAPTER 9 - MASTER CLOCK SYSTEM.....		77
9.1	General.....	77
9.2	Scope of Supply for Clock System	77
9.3	System Requirements	77
9.4	Performance Specifications.....	78
9.5	Technical Requirements	78
9.6	System Expansion.....	80
CHAPTER 10 - VHF COMMUNICATION SYSTEM		81
10.1	25 Watt VHF Transceivers.....	81
10.2	5 Watt VHF Walkie-Talkie Sets.....	82
10.3	General Requirements.....	84
CHAPTER 11 - VIDEO SURVEILLANCE SYSTEM REQUIREMENTS.....		86
11.1	General.....	86
11.2	Scope of Supply	86
11.3	System Requirements	86
11.4	Performance Requirements	87
11.5	Technical requirements.....	88
CHAPTER 12 - 48 V DC BATTERY BACKUP SYSTEM REQUIREMENTS		96
12.1	General.....	96
12.2	Design Requirements.....	96

12.3	Technical Requirements	96
CHAPTER 13 - INSTALLATION, EARTHING, LIGHTNING AND SURGE PROTECTION.....		98
13.1	General.....	98
13.2	Installation Programme	98
13.3	Installation Works in Equipment Rooms	99
13.4	Installation Works within Buildings.....	100
13.5	Outdoor Installation Works	100
13.6	Cab Radio Installation	101
13.7	Cabling.....	101
13.8	Identification	104
13.9	Marshalling and Termination	104
13.10	Power Supply Distribution.....	106
13.11	Earthing Policy.....	106
13.12	Transient and Lightning Protection.....	109
13.13	Lightning Protection	109
13.14	Housing, Enclosure and Cabinet.....	109
CHAPTER 14 - TESTING AND COMMISSIONING		111
14.1	General	111
14.2	Testing Stages.....	111
14.3	Factory Acceptance Tests	111
14.4	Installation Tests.....	112
14.5	System Acceptance Tests	112
14.6	Integrated Testing and Commissioning.....	114
14.7	Service Trials.....	115
CHAPTER 15 - SPARES, SPECIAL TOOLS AND TEST EQUIPMENT.....		116
15.1	Spares.....	116
15.2	Special Tools and Test Equipment.....	119
CHAPTER 16 – TRAINING		121
16.1	General	121
16.2	Training Plan	121
16.3	Training Courses	121
16.4	Training Materials.....	123
16.5	Training Records	123
16.6	Course Evaluation	123
CHAPTER 17 –INTERFACE REQUIREMENTS		125
17.1	General.....	125
17.2	Interface Management.....	125
17.3	Telecom System Interface Requirements.....	126

APPENDIX – I..... 130

APPENDIX – II..... 140

CHAPTER 1 - INTRODUCTION

1.1 General

- 1.1.1 Eastern Dedicated Freight Corridor (EDFC) Railway is from Sahnewal(Ludhiana) to Dankuni via Ambala-Saharanpur-Meerut-Hapur-Khurja-Aligarh-Tundla-Kanpur-Allahabad-Mughalsarai-Sonnagar-Gaya-Dhanbad-Asansol and also include section from Khurja to Dadri.
- 1.1.2 The Dadri-Khurja section of EDFC will be double line railway track with one Junction Station, New Boraki. This Dadri–Khurja section of EDFC includes connection through a double line railway tracks upto Dadri Yard of IR at north end and with New Khurja Yard of EDFC at south end. This Dadri–Khurja section of EDFC also includes double line railway track from New Boraki Station upto the boundary between EDFC & WDFC.
- 1.1.3 The Dadri-Khurja section of EDFC will be equipped with 25 kV AC, AT Feeding Electric Traction Power System under this Contract. Traction Power System includes Traction Sub-Station(TSS), and Sub-sectioning Post(SSP). Control and Monitoring of Traction Power System shall be via a Supervisory Control and Data Acquisition(SCADA) System.
- 1.1.4 For Dadri-Khurja section of EDFC, Integrated Maintenance Sub Depot (IMSD), has been planned at New Boraki. This depot will have maintenance facilities for all the concerned departments viz. Electrical, Civil, Signalling and Telecommunication.
- 1.1.5 The Centralized Operational Control Centre(OCC) for EDFC, being constructed at Allahabad under Contract Package CP-104, shall house equipment pertaining to Train Management Systems(TMSs), Traction Power SCADA Systems and Telecommunication Systems of the entire EDFC.
- 1.1.6 For Dadri-Khurja section of EDFC, residential quarters have been planned for its staff. The details of these residential quarters are given in General Specifications.
- 1.1.7 This specification details the requirements for the Telecommunication System to be provided for Dadri-Khurja section of EDFC.

1.2 Purpose

- 1.2.1 This Specification covers the Design, Manufacturing, Delivery, Installation, Testing & Commissioning and Defects Notification Period Support for the Telecommunication System to be supplied under this Contract.
- 1.2.2 The Main Purpose of the Telecommunication System shall be to provide Voice and Data Transmission Capabilities throughout the Dadri–Khurja section of EDFC to enable efficient operation and management of the Railway System. In addition, the Telecommunication System shall be required to distribute an accurate Time Signal throughout the Dadri-Khurja section of EDFC.
- 1.2.3 Telecommunication System shall also meet all the Data Communication requirements of Signalling Works, Electrification Works and E&M Works of Dadri-Khurja section of EDFC.

1.3 Scope of Work

1.3.1 General Requirements

- 1.3.1.1 The Telecommunication System shall be designed, manufactured, supplied, delivered, installed, tested and commissioned by the Contractor under this Contract to meet all the requirements as defined in this Particular Specifications.
- 1.3.1.2 The Telecommunication System shall include, but not be limited to, the Sub-systems viz, Optical Fibre Communication System, Data Networking System, Telephone System, GSM-

R based Mobile Train Radio System, Master Clock System, VHF Communication System, Video Surveillance System for TSS and 48 V DC Battery Backup System.

1.3.1.3 The scope shall include erection of towers in detour portion of the track near BTS as defined in this Particular Specifications.

1.3.1.4 The scope shall also include any extension/upgradation /augmentation /reconfiguration, as required, of equipment provided under Contract Packages CP-104 & CP-203 of EDFC along with the System Contract Packages STP-5 & CTP-14 of WDFC to meet the requirements as defined in this Particular Specifications.

1.3.2 **Scope of Supplies**

1.3.2.1 The scope of supply shall include all necessary Hardware, Software, Firmware, Accessories, Material and Documentation for Telecommunication System. The detailed requirements shall be as given in this Particular Specifications.

1.3.2.2 The scope of supply shall also include supply of Spares and Tools & Test Equipment as stipulated in this Particular Specifications.

1.3.3 **Scope of Services**

1.3.3.1 The scope of services to be performed by the Contractor shall include Design, Manufacturing, Delivery, System Assurance, Storage, Installation, Testing and Commissioning of the Telecommunication System. The detailed requirements shall be as given in this Particular Specifications and General Specifications.

1.3.3.2 The scope of services shall also include, but not limited to, Project Management, Interface Management, Quality Management, System Assurance Management, Safety Management, EMC Management, Design, Procurement & Manufacturing Management, Construction & Installation Management, Overall Site Supervision & Management, SHE Management, Completion Management, Defect Liability Management, etc.

1.3.3.3 The scope of services shall also include Maintenance Support Services including rectification & removal of defects during the Defect Notification Period and Training for Employer's Personnel.

1.4 **Relevant Documents**

1.4.1 This Particular Specifications (PS) shall be read in conjunction with the Conditions of Contract, the General Specifications (GS), and any other document forming part of the Contract.

1.4.2 In the event of a conflict between the GS and the PS-Telecommunication Works, the requirements of the PS-Telecommunication Works shall prevail.

1.4.3 In the event of a conflict between this document and others, the following precedence shall apply:

- (1) This Document-Particular Specification-Telecommunication Works.
- (2) General Specifications.
- (3) Indian Standards referenced in this document.
- (4) International Standards referenced in this document.
- (5) Other International Standards.
- (6) Other National Standards.

1.4.4 Notwithstanding the contents of sections above, the Contractor shall always immediately seek advice from the Engineer in the event of conflict(s) between specifications and decision of the Engineer shall be final and binding.

1.5 **Infringement of Patent Rights**

1.5.1 The Employer will not be responsible for infringement of Patent Rights arising due to similarity in design, manufacturing process, use of similar components in the design and

development and any other factor not mentioned herein which may cause such a dispute. The entire responsibility to settle any such dispute/matters shall lie with the Contractor.

*** End of Chapter 1 ***

CHAPTER 2 – ABBREVIATIONS & STANDARDS

2.1 Abbreviations

ACL	Access Control List
ALARP	As Low As Reasonably Practicable
ALH	Auto Location Hut
BGP	Border Gateway Protocol
BOQ	Bill of Quantity
BSC	Base Station Controller
BSS	Base Station Sub system
BTS	Base Transceiver Station
DC	Direct Current
DFC	Dedicated Freight Corridor
DFCC	Dedicated Freight Corridor Corporation
DHCP	Dynamic Host Configuration Protocol
DID	Direct Inward Dial
DNP	Defect Notification Period
DOD	Direct Outward Dial
DOT	Department of Telecom, Government of India
DLT	Direct Line Telephone
DTMF	Dual Tone Multiple Frequencies (Signalling)
DTN	Data Transmission Network
DWC	Double Wall Corrugated
EDFC	Eastern Dedicated Freight Corridor
EIRENE	European Integrated Railway Radio Enhanced Network
EMC	Electro Magnetic Compatibility
EMI	Electro Magnetic Interference
E&M	Electrical & Mechanical
EN	European Norm
EoS	Ethernet over SDH
EPL	Ethernet Private Line

EVPL	Ethernet Virtual Private Line
E-LAN	Ethernet Local Area Network
EoMPLS	Ethernet over MPLS
ETCS	European Train Control System
ETSI	European Telecommunication Standards Institute
FC	Fiber Channel
FRS	Functional Requirement Specifications
GCR	Group Call Register
GOS	Grade Of Service
GPS	Global Positioning System
GUI	Graphical User Interface
GSM	Global System for Mobile communication
GSM-R	Global System for Mobile communication – Railway
HCS	Hundred Call Seconds
HDPE	High Density Polyethylene
HLR	Home Location Register
HSRP	Hot Standby Router Protocol
ID	Identification
IMD	Integrated Maintenance Depot
IMSD	Integrated Maintenance Sub-Depot
IS-IS	Intermediate System to Intermediate System
IGMP	Internet Group Management Protocol
IEC	International Electro-technical Commission
IEEE	Institute of Electrical and Electronics Engineers
IOT	Inter-Operability Test
IP	Internet Protocol
IR	Indian Railways
IRS	Indian Railways Standards
ISDN	Integrated Services Digital Network
ITU	International Telecommunication Union

ITU-T	International Telecommunications Union – Telecommunication Standardization Sector
KMPH	Kilo Meter Per Hour
LAN	Local Area Network
LC	Level Crossing
LCD	Liquid Cristal Display
LDP	Label Distribution Protocol
L2PT	Layer 2 Protocol Tunneling
LED	Light-Emitting Diode
MDF	Main Distribution Frame
MMI	Man Machine Interface
MPLS	Multi-Protocol Label Switching
MSC	Mobile Switching Centre
MTBF	Mean Time Between Failure
MTRC	Mobile Train Radio Communication
MTTR	Mean Time To Repair
NMS	Network Management System
NTP	Network Time Protocol
OCC	Operation Control Centre
ODF	Optical Distribution Frame
OFC	Optical Fiber Communication
OEM	Original Equipment Manufacturer
OSPF	Open Shortest Path First
PBX	Private Branch Exchange
PCM	Pulse Code Modulation
PDH	Plesio-chronous Digital Hierarchy
PIJF	Paper Insulated Jelly Filled
POP	Point of Presence
PSTN	Public Switched Telephone Network
PTT	Press To Talk
QoS	Quality of Service

RA	Remote Access
RAMS	Reliability, Availability, Maintainability and Safety
RCIL	RailTel Corporation of India Limited
RDSO	Research Design and Standards Organization
RH	Relative Humidity
RDC	Radio Dispatcher Console
REC	Railway Emergency Call
RF	Radio Frequency
RSI	Repetitive Strain Injury
SC	Station Controller
SCADA	Supervisory Control and Data Acquisition
SCR	Station Controller Room
SDH	Synchronous Digital Hierarchy
SHE	Safety, Health and Environment
SINAD	Signal to Noise And Distortion Ratio
SM	Single Mode
SMSC	Short Message Service Centre
SNCP	Sub-Network Connection Protection
SOD	Schedule of Dimension
SP	Sectioning Post
SRS	System Requirement Specifications
SSP	Sub-Sectioning Post
S&T	Signalling & Telecommunication
TDM	Time Division Multiplexing
TER	Telecommunication Equipment Room
STM	Synchronous Transport Module
TCP/IP	Transmission Control Protocol / Internet Protocol
TMN	Telecommunications Management Network
TPC	Traction Power Controller
T-LDP	Targeted Label Distribution Protocol
TSS	Traction Sub-Station

TRAU	Trans-coder Rate Adaption Unit
TRX	Transceiver
UPS	Uninterruptible Power Supply
UPSR	Uni-directional Path Switched Ring
UTC	Universal Time Co-ordinate
VC	Virtual Container
VDU	Video Display Unit
VMS	Voice Mail System
VPN	Virtual Private Network
VRS	Voice Recording System
VF	Voice Frequency
VHF	Very High Frequency
VoIP	Voice over IP
VLAN	Virtual Local Area Network
VLR	Visitor Location Register
VPWS	Virtual Private Wire Services
VRLA	Valve Regulated Lead Acid
WAN	Wide Area Network
WDFC	Western Dedicated Freight Corridor
WPC	Wireless Planning Committee

2.2 List of standards/Specifications

STANDARDS/SPECIFICATIONS	TOPIC
IEC 62278	RAMS
EN 50121, IEC 61000	EMC - Intra & Inter System
EN 50121, IEC 61000	EMI – Equipment is adequately protected against EMI, EMC – EMC testing
ITU-T Rec. 803	Proven SDH technology
EN-50159	All vital & safety related information shall be implemented as per this standard in both First & Second OFC network
G.7041	SDH equipment shall be equipped with EoS at 10/100 Base T
IEEE 802.1d	In-built Layer-2 Bridging & Aggregation functionality
IEEE 802	Layer-3, Layer-2 switches shall support: IEEE 802.3ad – Link aggregation control IEEE 802.1Q – VLAN on all ports IEEE 802.1q – VLAN (tagging) IEEE 802.1x – Port based authentication IEEE 802.1d – Spanning Tree Protocol IEEE 802.1s – Multiple Spanning Tree Protocol IEEE 802.1w – Rapid Spanning Tree Protocol
IEEE 802	Layer 2 Switch IEEE 802.3 – Support Half Duplex IEEE 802.3u – Full Duplex IEEE 802.3ab – Auto Negotiation
RFC 2138	For DHCP, RADIUS Protocol
IEEE 802.1p	Classification & Scheduling on all ports
IEEE 802.1x	Access control mechanism via Authentication, Authorization & Cryptographic key Validation
RDSO/SPN/TC/66/2007 or Latest	RDSO Specifications for Control Communication System shall have equipment as per RDSO specs
IRS: TC 30-05 or Latest	RDSO Specifications for Underground Jelly Filled Telecom Quad cable
IEC 60065 IEC 60364	All equipment must comply to System Safety Requirement
ITU-T Rec. G.822	Allowable clock slip in PBX network internal clock when Master Clock is absent
IRS: TC 41-97 or Latest	RDSO Specifications for Polythene Insulated Jelly Filled Cable
EIRENE FRS 7.3 EIRENE SRS15.3	MTRC
STT/WL/MTRC/503 Dated 11.11.2005	RDSO Letter on Numbering Plan

IEC 60950	Safety of Information Technology Equipment
IEC 60364	Electrical Installations of Buildings
EIA/TIA-222-E IS 800,808, 226/2062/ 1367,1161, 2629,5358	Antenna Tower at Radio Base Station
IS 4759	Hot dipped galvanized iron compliance for towers
IEEE 802.3af	PoE
RDSO/SPN/TL/23/99 Ver 4.0 or Latest	RDSO Specifications for Battery Chargers
RDSO Spec: IRS: S93-96 TEC Spec: GR/BAT-01/03 March 2004	VRLA battery cells
ITU-T Rec. G.652	ODF: Optical connectors compliance
IEC 62305 IEC 62561 IEC 60364	Earthing System Standards
ITU-T M-3010	ITU-T Recommendation on Principles for Telecommunication Management Network.
ITU-T Rec. G.823	ITU-T Recommendation on control of Jitter and Wander in 2 Mbps Digital Network.
ITU-T Rec. G.825	ITU-T Recommendation on control of Jitter and Wander in SDH Digital Network.
ITU-T Rec. G.712	ITU-T Recommendation on Transmission performance characteristics of Pulse Code Modulation (PCM) channels.
ITU-T Rec. G.821	ITU-T Recommendation on Error performance of an international Digital Connection.
IRS: TC 55-2006 or Latest	RDSO specification for 24 F Armoured Optical Fibre Cable.
IEC 60793 & IEC 60874	IEC Specification for Optical Fibres and Connectors.

*** End of Chapter 2 ***

CHAPTER 3 - PERFORMANCE REQUIREMENTS

3.1 General

- 3.1.1 The Contractor shall ensure that all equipment and material used shall meet the specified availability throughout its service life as required to minimise disruption to the train operation and to minimise the maintenance costs.
- 3.1.2 The System excluding battery cells shall be so designed as to have a minimum of 15 years of Service Life operating continuously. The life of Valve Regulated Lead Acid Battery Cells shall not be less than 7 years. Further, the life of all the cables including Optical Fibre Cables, Jelly Filled Telecom Quad Cable, Telephone Cables and RF Cables shall not be lower than 25 years and life of Radio Towers/Mast shall not be less than 40 years.
- 3.1.3 The System shall be designed to facilitate freight train and station operation, management of incidents and abnormal operations as well as of emergencies.
- 3.1.4 The System shall, to the extent practicable, have no credible failure mode, which will directly cause an interruption or delay in the freight services. The Contractor shall demonstrate that the probability of occurrence of the credible failure mode, if any, has been reduced to ALARP (As Low As Reasonably Practicable) and no further cost-effective means of improving reliability can be identified.
- 3.1.5 Reliability-Availability-Maintainability-Safety (RAMS) Plan for Telecommunication System shall be developed and implemented in accordance with IEC 62278.
- 3.1.6 Wherever the equipment being provided under Contract Packages CP-104 & CP-203 for EDFC is being upgraded/augmented/reconfigured, the service life of these upgraded/augmented/reconfigured equipment shall be minimum 15 years from date of commissioning of this upgradation/augmentation/reconfiguration.

3.2 Reliability Requirements

- 3.2.1 The inability to perform a required function, the occurrence of unexpected action by the equipment, or the degradation of performance to below the required specifications shall constitute a failure.
- 3.2.2 The Contractor shall submit Mean-Time-Between-Failures (MTBF) figure for major equipment of each sub-system as specified in relevant chapters of this Particular Specification. It should be possible to achieve the required level of system availability, as specified in the relevant chapters of this Particular Specification, with these MTBF figures.
- 3.2.3 The Contractor shall submit Reliability Plan to the Engineer for review in accordance with RAMS Plan.
- 3.2.4 The Reliability Plan shall describe the analytical methods to be used during design and development to demonstrate compliance with reliability requirements and identification of reliability-critical items in the System offered.
- 3.2.5 The Reliability Plan shall identify a comprehensive list of reliability-related submissions such as specifications, standards, method statements, procedures, drawings and records to the Engineer for review.

3.3 Availability Requirements

- 3.3.1 Detailed availability requirements for individual sub-systems are given in relevant Chapters of this Particular Specification.
- 3.3.2 The Contractor shall submit calculations with reliability block diagrams for each sub-system to demonstrate the compliance with required availability figures. The availability

calculation shall take all possible failure modes into consideration. The calculation shall be based on the Contractor's submitted equipment MTBF figures, MTTR figures and the configuration of each sub-system.

- 3.3.3 Equipment duplication, hot-standby protection, parallel-run, path diversity, etc. shall be adopted whenever necessary and appropriate to meet the required availability.
- 3.3.4 Error detection and correction mechanism shall be included in the communication links as appropriate depending on the nature and functional criticality of the data conveyed.
- 3.3.5 Switchover between redundant equipment, or between redundant routings, shall occur automatically and immediately upon failure and shall be transparent to the users. Toggling in switchovers shall be prevented.
- 3.3.6 The Contractor shall conduct analysis and propose methods, if any, for further improvement of the availability of each sub-system beyond the minimum required availability figures mentioned above.

3.4 Maintainability Requirements

- 3.4.1 The Contractor's Response Time during Defect Notification Period shall not exceed two hours. The Contractor's Response Time is defined as the time that elapses between the reporting of a fault and the maintenance personnel arriving at site where the faulty equipment is located.
- 3.4.2 The System shall be designed such that the Mean Time to Repair (MTTR) shall not exceed 2 hours. The MTTR shall include the diagnostic time, active repair/replacement time and adjustment/testing time on site, but shall exclude the Contractor's Response Time.
- 3.4.3 All plug-in modules shall permit hot swapping so as not to affect the normal or emergency operation of the System.
- 3.4.4 The System shall be suitably designed to minimise the need for frequent preventive maintenance.
- 3.4.5 The System shall be so designed as to avoid the need for a total shutdown for preventive maintenance.
- 3.4.6 The System shall be so designed as to prevent failures or breakdown due to invalid or incorrect inputs.
- 3.4.7 Built-in self-diagnostics, power-up self-test and sufficient test points shall be provided in the System to minimise the time required to locate a fault.
- 3.4.8 All components, material, software and support required for repair and servicing of the System shall be available during the entire lifetime of the System.
- 3.4.9 The Contractor shall submit Maintainability Plan to the Engineer for review in accordance with RAMS Plan.
- 3.4.10 The Maintainability Plan shall describe the analytical methods to be used during design and development stages to demonstrate compliance with maintainability requirements specified herein and to identify the maintainability-critical items of the System.
- 3.4.11 The Maintainability Plan shall identify a comprehensive list of maintainability-related submissions such as specifications, standards, method statements, procedures, drawing and records to the Engineer for review. The Maintainability Plan shall include the date of submission.

3.5 System Safety Requirements

- 3.5.1 The Contractor shall support other Project Contractors with the provision of information and relevant analysis where the availability and usability of the Telecommunications System is a contributing factor to the overall system risk.
- 3.5.2 All Man-Machine-Interfaces shall be designed with the risk of Repetitive Strain Injury (RSI), eye strain and radiation-induced illness (both non-ionising and ionising radiation) taken into consideration.
- 3.5.3 The design of the System shall minimise the risk of fire.
- 3.5.4 The design of the System shall minimise the build-up of static, as well as the effects of static discharge during maintenance.
- 3.5.5 Components or materials containing toxic chemicals or asbestos shall not be used in the System unless absolutely necessary and unavoidable. Specific approval of the Engineer shall be obtained before using these components or materials containing toxic chemicals or asbestos.
- 3.6 Electromagnetic Compatibility (EMC)**
- 3.6.1 The Contractor shall prepare and submit EMC Management Plan for review by the Engineer, which shall be based upon a top-down approach, define the EMC philosophy, activities, means of control for the design processes and EMC submissions to be supplied to demonstrate compliance with the PS and GS. The EMC Management Plan shall also identify a comprehensive list of specifications, standards, method statements and procedures to be submitted to the Engineer for review.
- 3.6.2 In respect of the EMC Design Documentation, the Contractor shall demonstrate by theoretical analysis that the design of the electrical and electronic systems under this PS, is fully compliant with the EMC requirements identified.
- 3.6.3 The Contractor shall provide detailed calculations and inter-modulation analysis to establish electromagnetic compatibility (EMC) among the Sub-systems and with other systems in close proximity as part of EMC Design Documentation.
- 3.6.4 The Contractor shall ensure that all Intra-system EMC are taken care of through proper design and other measures in accordance with EN 50121 and IEC 61000.
- 3.6.5 The Contractor shall liaise and co-ordinate with all other Contractors in the exchange of EMC data and related equipment performance characteristics. Inter-system EMC between Telecommunication System and other electrical and electronic equipment shall be in accordance with EN 50121 and IEC 61000.
- 3.6.6 The Contractor shall ensure that all electrical and electronic apparatus of Telecommunication System is designed and protected against electromagnetic interference in accordance with EN 50121 and IEC 61000, to operate without degradation of quality, performance or loss of function in the electromagnetic environment of the Project. Adequate safety margins between the immunity levels of the Telecommunication System and the emission levels of other electrical and electronic equipment must be maintained.
- 3.6.7 The cost incurred in the suppression of electromagnetic or electrostatic interference including any hardware shall be deemed to be included within the Contract.
- 3.6.8 EMC considerations shall be incorporated in the Contractor's procedures for product safety and design Verification.
- 3.6.9 EMC Testing shall be carried out on all equipment identified in the design stage which requires attention regarding EMC in accordance with IEC 61000 and to meet overall compliance to EN 50121.

- 3.6.10 Relevant EMC test certificates for all standard off-the-shelf products shall be submitted to the Engineer for review.
- 3.6.11 The Contractor shall implement corrective actions to rectify any EMC problems identified during design, on-site testing and when the whole system is in operational service.
- 3.6.12 The Contractor must be fully aware of the EMC requirements and any modifications to systems and equipment carried out by the Contractor during the Defects Notification Period shall not cause the immunity, or emission levels of the installed system and equipment to exceed such values.
- 3.6.13 Any equipment consisting of sensitive electronic components that is likely to be handled or touched by any person shall be protected against electrostatic discharge and shall be tested as defined in IEC 61000-4-2.

*** End of Chapter 3 ***

CHAPTER 4 - DESIGN REQUIREMENTS

4.1 Design Approach

- 4.1.1 The Contractor shall adopt a structured, modular and top-down approach for the design and exercise proper design control to ensure that the designs are in accordance with the requirements given in the Specifications.
- 4.1.2 The technologies adopted for the design of Telecommunication System shall be:
- (1) field proven with past successful applications references
 - (2) conforming to open international standards
- 4.1.3 The System shall be designed for continuous unattended operation for extended periods of time.
- 4.1.4 The Contractor shall submit a Design Plan. The design shall be in three stages of Preliminary Design, Detailed Design and Installation Design. The Design Plan shall define Contractor's policy for the design of works and shall without limitation, define;
- (1) The organization of Contractor's design staff with particular reference to the design interfaces in detail;
 - (2) The specific allocation of responsibility and authority given to identified staff with particular reference to the review and verification of design specification, drawings and calculations by the Contractor in detail;
 - (3) The design and performance requirements which shall be defined in terms of basic data and design assumptions made, relevant codes, standards and regulatory requirements, safety, reliability, security and environmental requirements and commissioning requirements in detail;
 - (4) The process of formal design review, authorization and approval of design documentation; and
 - (5) The process of independent design Verification and Validation.
- 4.1.5 During the Preliminary Design, the Contractor shall prepare System Requirement Specifications (SRSs) for each Sub-system and submit to the Engineer for review, which includes, as a minimum, operational, functional, performance and design requirements. System Requirement Specification shall serve as Contractor's top level design document and shall state all the requirements completely and unambiguously and how each requirement can be verified and validated.
- 4.1.6 Preliminary Design of individual Sub-systems shall be prepared and submitted to the Engineer for review, which includes, as a minimum, the function of each System, Sub-system, equipment or other element within the overall SRS and specify the relationship and interfaces between each element of the System, including the systems of the interfacing elements of the other Contractors. Alongwith Preliminary Design, certificates from accredited organization/agency certifying compliance to Standards/Specifications for proposed equipments shall be submitted.
- 4.1.7 The Detailed Design for individual Sub-systems shall be developed based on the Preliminary Design for individual Sub-systems and submitted to the Engineer for review. Detailed Design shall also include electrical and control schematics to illustrate, how the various operational and functional requirements can be achieved.
- 4.1.8 Software design & development shall also be carried out during Detailed Design stage, and details shall be included in the Detailed Design Submissions for review of Engineer.
- 4.1.9 The Detailed Design shall include as necessary all technical aspects of all interfaces with other elements of the Contractor's overall design and of any interfaces with works being supplied by other Contractors. Detailed interconnection specification shall also be developed during this stage and included in the Detailed Design.

- 4.1.10 The Detailed Design shall also include detailed design calculations and supporting drawings, documents, etc., for the applicable subsystems. The design calculations shall demonstrate that the Contractor's Design fully complies with the requirements given in the specifications and shall further demonstrate that the ratings, capacity and quantity of the proposed equipment are adequate.
- 4.1.11 The Contractor shall also furnish the following calculations and analysis for each Sub-system as a minimum:
- (1) Estimation of the power consumption and heat dissipation per equipment location.
 - (2) Prediction of the reliability and availability of the Sub-systems.
- 4.1.12 Upon approval of Detailed Design, the Contractor shall produce the respective Installation Design, which shall include, inter - alia, the Equipment Layout Drawings, System Specifications, Installation Drawings, Cable Route Plan, Circuit Diagrams, Termination Plans, Configuration Details and all other associated documents necessary to supplement the design covered in the Detailed Design and to comply with the Contract regarding the installation of the equipment such as detailed Method Statement, Safety Risk Assessment etc.
- 4.1.13 As part of Installation Design, specified clearance as per SOD of track side equipment in millimetres from centre line of adjacent track(s) shall be prepared in a tabular form.
- 4.1.14 Only those drawings and documents of Installation Design that have been endorsed and certified as having been reviewed shall be issued to the Site.
- 4.1.15 If the Contractor identifies the need for any change to the design due to site conditions or other reason, then the Contractor shall produce a Design Change Notice or Field Change Notice.
- 4.1.16 The Design Verification and Validation Plan, supplementary to Design Plan shall be prepared by the Contractor in order that design Verification and Validation activities are properly directed.
- 4.1.17 The Contractor shall by means of the design Verification and Validation process demonstrate that all requirements within the specifications have been met. For this the Contractor shall prepare a Design Verification Table (DVT) that identifies the Contractor's proposed methodology for demonstrating compliance and submit to the Engineer for review. DVT shall include Acceptance Criteria for achieving the requirement. DVT shall be monitored throughout the design and construction of the works. Changes, if any, to the DVT, shall be submitted to the Engineer for review before implementation.
- 4.2 Design Review**
- 4.2.1 The Contractor shall ensure that all design submissions are accurate, fully compliant, relevant and of good quality before they are submitted to the Engineer for review.
- 4.2.2 The Contractor shall ensure that all comments of the Engineer have been properly incorporated or otherwise resolved before resubmission.
- 4.2.3 The Contractor shall exercise adequate control to ensure that the number of resubmissions is a minimum.
- 4.2.4 The following issues shall be addressed during Design Review Meetings:
- Design Progress
 - Interface Issues
- 4.2.5 In terms of Sub-Clause 3.1 of Conditions of Contract (General Conditions of Contract & Particular Conditions of Contract), the Engineer shall obtain approval of Employer for Preliminary Design and Detailed Design Submissions.

4.3 Man Machine Interface Design

- 4.3.1 For all MMIs specially designed or customised for the System, the Contractor shall provide and organise prototypes for demonstration and submission to the Engineer for review prior to implementation.
- 4.3.2 All MMIs shall be equipped with virus checking and anti-virus protection facilities to prevent from virus infection.
- 4.3.3 The Contractor shall co-ordinate with the Other Contractors to ensure that the latter's recommendations are properly reviewed, commented upon and the agreed items incorporated in the Contractor's MMI design.

4.4 Submission of Samples

- 4.4.1 The Contractor shall submit samples to the Engineer for review, when so required and instructed by latter.
- 4.4.2 The Contractor shall arrange site visits and/or videos for illustration if the items are bulky or impracticable for submission.
- 4.4.3 The Contractor shall provide samples of individual types of cables to the Engineer prior to the commencement of cable installation. The samples shall be properly protected with transparent housing for independent cable components including sheath, armour, insulation, cable cores, etc. for ease of identification as well as inspection. Each sample shall be properly labelled with description of the cable type.
- 4.4.4 All samples submitted to the Engineer shall become the property of the Employer.

4.5 Equipment Design

4.5.1 General Considerations

- (1) Specific equipment design requirements for individual Subsystems are given in relevant chapters of this Particular Specification.
- (2) The offered equipment shall be field proven with past history of successful performance in railway environment.
- (3) All equipment shall be designed and constructed to operate without degradation in quality, performance or loss of function in the electromagnetic environment prevalent in a standard Heavy Freight Corridor Railway System.
- (4) All Housing, Enclosures and Cabinets housing outdoor equipment shall be compliant to IP65 for Ingress Protection.

4.5.2 Fire and Smoke Precautions.

- (1) The cable routes shall be suitably designed to prevent trapping of rubbish which could later become a fire hazard.
- (2) Every possible precaution must be taken to prevent the flow of fault currents through the cables, especially from the traction power system. Communication cables must be kept away from high tension power supply cables.
- (3) All necessary measures shall be adopted to prevent the creation of hazardous conditions arising out of overheating and/or ignition of cables.
- (4) All of the above requirements shall be fully complied with without compromising any of the mechanical or electrical properties of the cables.

4.6 Environmental Conditions

- 4.6.1 All equipment shall be protected from damage or degradation in performance due to shock

or vibration as experienced in railway environment.

- 4.6.2 Unless otherwise specified, all indoor Telecommunication Equipment installations shall be designed for operation continuously in environmental temperature range of -5°C to +55°C.
- 4.6.3 Telecommunication Equipment Room (TER) at New Boraki Station, Auto Location Huts, Interfacing IR Station, GSM-R Locations, TSS, SSPs, IMSD and Staff Residential Colonies etc. shall be provided with air-conditioning. Air-Conditioning in TERs at above locations shall be provided by the Contractor under this Contract. TERs at above locations are classified as 'Class-B1' under Clause 2.17.6 of General Specifications.
- 4.6.4 Telecom Power Supply Equipment Rooms at New Boraki Station, Auto Location Huts, Interfacing IR Station, GSM-R Locations, TSS, SSPs, IMSD, Staff Residential Colonies etc. shall be provided with suitable means to regulate temperature and maintain air-circulation with 1+1 standby within limits so as to facilitate proper working of Power Supply Equipment and VRLA battery as during summer time the temperature inside the equipment room is likely to reach very high levels. These provisions to regulate temperature and maintain air-circulation shall be provided by Contractor under this Contract. Telecom Power Supply Equipment Rooms at these locations are classified as 'Class-B2' under Clause 2.17.6 of General Specifications.
- 4.6.5 Arrangement for remote monitoring of the air-conditioning system, temperature regulator equipments and air-circulation equipments of Telecommunication Equipment Room (TER) and Telecom Power Supply Equipment Rooms from OCC shall be provided.

***End of Chapter 4 ***

CHAPTER 5 - OPTICAL FIBRE COMMUNICATION SYSTEM REQUIREMENTS

5.1 General

- 5.1.1 The OFC System shall be a highly reliable system since it shall be the primary means of communications between OCC, Stations, Auto Location Huts, Interfacing IR Stations, GSM-R Locations, TSS, SSPs, IMSD, Staff Quarters etc. on which a number of other operationally critical systems will rely.
- 5.1.2 The OFC System shall provide a high degree of availability and redundancy by operating on two independent optical fibre rings. Proven technology of SDH (Synchronous Digital Hierarchy) as per ITU-T Rec. G.803 shall be used.
- 5.1.3 The OFC System shall be capable to transport all of the user communication requirements. The OFC System shall provide sufficient bandwidth to cater for the communication requirements of various systems under this Contract as well as communication requirements of various systems of Eastern Corridor & Western Corridor in Dadri-Khurja section.
- 5.1.4 This OFC system being provided under Contract Package CP-105 shall be integrated with OFC System being provided under Contract Package CP-203 for Mughalsarai to New Bhaupur section of EDFC, Contract Package CP-104 for Bhaupur-Khurja section of EDFC and Contract Package CTP-14 for Rewari-Dadri section of WDFC.
- 5.1.5 Whenever existing equipment provided under Contract Packages CP-104 & CP-203 are upgraded/augmented to meet the requirement of this Particular Specifications, the available provision for redundancy in existing equipment shall not be compromised and subsequent to upgradation/augmentation they shall meet the Technical Requirement and Performance Requirement as stipulated in this Particular Specifications.

5.2 Scope of Supply for OFC System

- 5.2.1 The scope of supply shall include, but not be limited to, the following:
- (1) SDH Equipment;
 - (2) Flexible Access Multiplex Equipment;
 - (3) Network Management System for OFC System;
 - (4) All required software and licenses;
 - (5) Single Mode Optical Fibre Cables;
 - (6) Splice Boxes and Remake Loops
 - (7) Distribution Frames;
 - (8) Equipment Cabinets, Racks and Cubicles;
 - (9) Terminating and Interconnecting Equipment;
 - (10) All required connectors;
 - (11) Installation materials;
 - (12) All required accessories;
 - (13) All required power and data cables; and
 - (14) Earthing Arrangement and Termination Protection Devices.

5.3 System Requirements

- 5.3.1 The OFC System shall be a Synchronous Digital Hierarchy (SDH) Optic Fibre Communication Network based on open standards and fully conforming to the relevant ITU-T Recommendations.
- 5.3.2 The OFC System shall support voice, data and video signal transmission between various locations and modes of transmission shall include, but not be limited to:
- (1) point-to-point;
 - (2) point-to-multipoint;
 - (3) drop-and-insert;
 - (4) cross-connect; and
 - (5) any other modes required for the implementation of the Subsystems.

5.3.3 Optical Fibre Cable Network

- 5.3.3.1 There shall be two separate optical fibre cable backbone networks namely First Network and Second Network. Each of these two networks shall be formed by two outdoor single mode optical fibre cables. The normal and protected routes of these networks shall be routed through different fibre cables with route diversity.
- 5.3.3.2 The First Network shall be formed by two OF cables, preferably one laid along the up-track and the other laid along the down-track ensuring route diversity.
- This First Network from New Boraki to New Dadri (WDFC) shall be integrated with First Network of WDFC being provided under Contract Package CTP-14. The Contractor shall lay 48 Fibre OF Cables one each along UP & DN tracks from TER at New Boraki station upto the point where tracks of EDFC & WDFC join. These 48 Fibres OF Cables of WDFC & EDFC shall be spliced and made through between TERs at New Dadri and New Boraki Stations. The splicing shall be done by the Contractor. These OF Cables shall be terminated in ODF/FMS at the respective station TERs and jointly tested by the CTP-14 and CP-105 Contractors.
- This First Network from New Boraki to New Khurja shall be integrated with First Network of EDFC being provided under Contract Package CP-104. The Contractor shall lay 24 Fibre (minimum) OF cables one each along UP & DN tracks from TER at New Boraki station upto the point where OF cable under Contract Package CP-104 is being laid. These OF Cables shall be spliced and made through between TERs at New Khurja and New Boraki Stations. The splicing shall be done by the Contractor. These OF Cables shall be terminated in ODF/FMS at the respective station TERs and jointly tested by the CP-104 and CP-105 Contractors.
- 5.3.3.3 The Second Network shall be formed by two 24 Fibre (minimum) OF cables, preferably one laid along the up-track and the other laid along the down-track ensuring route diversity, from New Khurja (point where OF cable under Contract Package CP-104 is being laid) to New Boraki to Dadri station of IR and terminated on ODFs in TERs at New Boraki station and Dadri station of IR, Auto Location Huts, GSM-R Locations, TSS, SSPs, IMSD, Staff Quarters and any other locations as required. Locations of termination of optical fibre cables of Second Network can be clubbed based upon design of other Systems/Sub-systems under this Contract while meeting overall Telecommunication Requirements.
- 5.3.3.4 In addition to SDH Network, optical fibres shall also be used for Data Networking System (as stipulated in Chapter-6) and Signalling Systems, as required.
- 5.3.3.5 At least 25% of fibres within each cable shall be reserved as spares for future use.
- 5.3.3.6 The optical fibre cables within Station/IMSD and along the track shall be laid along different routes to provide 100% route diversity.
- 5.3.3.7 At least 10 metres slack in each optical fibre cable at all equivalent rooms shall be reserved for future network modification before taking cables to ODFs.
- 5.3.3.8 At least 10 meter optical fibre cable loop shall be provided for each cable inside a suitable underground chamber at all Optical Fibre Cables jointing locations.
- 5.3.3.9 All fibres of optical fibre cables, including the spare fibres, at ODF shall be either spliced through or spliced with optical pigtailed or terminated at the optical patch panels.
- 5.3.3.10 Optical Fibre Cable shall also be laid from SER/TER of Stations/Auto Location Huts to Field Units/Track Devices of Track Vacancy Detection System, as required, to meet the requirements of Particular Specifications-Signalling Works.
- 5.3.4 **SDH Network**
- 5.3.4.1 The SDH Nodes shall consist of STM Multiplexers with Optical Line Terminals connected to optical fibre cable backbone networks to form the SDH Network of the OFC System.
- 5.3.4.2 The First Network shall carry all Voice & Data Communication between OCC and New Boraki Station. The First Network shall also carry all Train Management System information and other Vital & Safety Related Information between OCC and Stations. All Vital & Safety Related System using OFC System shall be implemented as per EN-50159.
- 5.3.4.3 The Second Network shall carry all Voice (including Emergency Communication) and Data (including Traction Power SCADA and Auxiliary SCADA) Communication between New

Boraki Station, Auto Location Huts, Interfacing IR Stations, GSM-R Locations, TSS, SSPs, IMSD, and Staff Quarters etc.

The Second Network shall also carry all Signal Control Information, Track Vacancy Detection Information and other Vital & Safety Related Information between New Boraki Station, New Khurja Station, Auto Location Huts, and Interfacing IR Station. All Vital & Safety Related System using OFC System shall be implemented as per EN-50159.

- 5.3.4.4 Each SDH Node of the First Network shall be at least STM-16 level or higher in the SDH hierarchy. The exact level of SDH Node in SDH hierarchy shall be determined by the Contractor to meet the bandwidth requirements for sub-systems under this Contract as well as communication requirements of Eastern Corridor & Western Corridor passing through Dadri-Khurja section of EDFC with 50% spare capacity. SDH Node of First Network shall be equipped with minimum 2XSTM-16o and 4XSTM-4o Interfaces.

STM-16 Nodes provided at New Dadri and New Boraki by the CTP-14 and CP-105 Contractors for respective SDH Networks of WDFC and EDFC shall be of Cross Connect Type. These Nodes shall be provided with sufficient number of STM-16o Interfaces for integration of these two SDH Networks at STM-16o level. These two SDH Nodes of New Dadri and New Boraki shall be connected to each other in redundant architecture with Linear Multiplex Section Protection or SNCP.

STM-16 Nodes provided at New Khurja and New Boraki by the CP-104 and CP-105 Contractors for respective SDH Networks shall be of Cross Connect Type. These Nodes shall be provided with sufficient no. of STM-16o Interfaces for integration of these two SDH Networks at STM16o level. These two SDH Nodes of New Khurja and New Boraki shall be connected to each other in redundant architecture with Linear Multiplex Section Protection or SNCP by extending ring being provided under Contract Package CP-104.

With above integration, it shall be possible to make provisioning of VC4s and VC12s across SDH Nodes provided under this Contract as well as under Contract Packages CP-104 and CTP-14 to meet the requirement of various systems/subsystems under this Contract as well as under Contract Packages CP-104 & CTP -14.

- 5.3.4.5 Each SDH node of the Second Network shall be at least STM-4 level or higher in the SDH hierarchy. The exact level of SDH Node in SDH hierarchy shall be determined by the Contractor to meet the bandwidth requirements for subsystems under this Contract with 50% Spare Capacity. SDH Node of Second Network shall be equipped with minimum 4XSTM-4o Interfaces.
- 5.3.4.6 SDH Nodes at New Boraki Station shall be common for First Network & Second Network and equipped with Digital Cross Connect at VC4 and VC12 levels.
- 5.3.4.7 SDH Traffic from New Boraki Station shall be carried over to OCC using dedicated VC4s over First Network being provided under the Contracts CP-104 and CP-203. This traffic shall be terminated at SDH Node at OCC being provided under Contract Package CP-104.
- 5.3.4.8 Control/Processor Card (if its failure results in affecting traffic), Switch/Matrix Unit & Power Supply Modules of SDH Equipment shall be provided with 1+1 Protection.
- 5.3.4.9 SDH Node at New Boraki shall be equipped with additional 3xSTM-16o interfaces for their future integration with SDH Network of New Khurja–Pilkhani section of EDFC.
- 5.3.4.10 SDH Equipments shall be equipped with Ethernet over SDH(EoS) as per ITU-T Rec. 7041 at 10/100 BaseT. This Ethernet over SDH (EoS) shall facilitate delivery of Ethernet Private Line (EPL) Services, Ethernet Virtual Private Line (EVPL) Services and Ethernet Local Area Network (E-LAN) Services. The EoS shall support Layer-2 encapsulation and forwarding through Multiprotocol Label Switching (MPLS).
- 5.3.4.11 In order to realize the above mentioned services, there shall be in-built Layer-2 Bridging & Aggregation functionally as per IEEE 802.1d. There shall be support for VLAN Stacking (Q-in-Q) as per IEEE 802.1ad on all ports. The equipment shall support Ethernet Link OAM in accordance with IEEE 802.3ah. The equipment shall also support Link Aggregation & Protection on service and trunk ports as per IEEE 802.3ad.

5.3.5 Access Network

- 5.3.5.1 Each SDH Node shall support direct access of tributary signals including, but not be limited to:
- STM optical and electrical signals of same/lower levels;
 - 2Mbps or the E1 tributaries;
 - Ethernet tributaries at 10/100 BaseT;
- 5.3.5.2 The SDH Nodes shall be fully equipped minimum for 63 (sixty three) 2 Mbps tributaries. All the tributaries shall be terminated on distribution frame for access.
- 5.3.5.3 Protection switching mechanisms shall be provided for the tributaries of the SDH Node. 2 Mbps tributaries shall be provided with 1:3 (Minimum) Protection and all the other tributaries shall be provided with 1+1 Protection.
- 5.3.5.4 The SDH Nodes of First Network shall be equipped with minimum 8 Ethernet 10/100 BaseT tributaries. SDH Nodes of Second Network (excluding at Stations) shall be equipped with minimum 4 Ethernet 10/100 Base T tributaries.
- 5.3.5.5 Flexible Access Multiplexers or Primary Order Multiplexer shall be provided with each and every SDH Nodes to connect to the 2Mbps tributaries of the SDH Nodes for direct access of channel circuits with data rate lower than 2Mbps.
- 5.3.5.6 Flexible Access Multiplexer or Primary Order Multiplexer shall have minimum 50% spares for all types of Channel Circuits (Minimum 1 for all types of Channel Circuits).
- 5.3.5.7 All the channel circuits, including spare circuits, shall be terminated at the main distribution frame, digital distribution frame as appropriate for circuit access.
- 5.3.5.8 The OFC System shall provide Voice and Data Communication Network/Channels or Bandwidth to meet the requirement for system/subsystems being provided under this Contract.
- 5.3.5.9 Ethernet Connections for each application need to be implemented through Ethernet Virtual Private Line Service.
- 5.3.5.10 The OFC System shall include a bandwidth management tool to ensure sufficient transmission capacity for each application to function under all traffic circumstances on the OFC System.
- 5.3.6 OFC System Network Synchronisation**
- 5.3.6.1 The OFC System Synchronisation shall adopt master and slave synchronisation method.
- 5.3.6.2 The Network Element equipment shall support programmable prioritized synchronization source selection scheme covering all available synchronization sources.
- 5.3.6.3 The SDH Equipment shall derive the synchronisation timing signal from, but not limited to the following in order of priority;
- Master Clock Equipment;
 - an internal clock of the SDH Equipment;
 - incoming STM Signal;
 - incoming 2 Mbps Signal
- 5.3.6.4 The SDH equipment shall switch automatically to another timing reference if the selected timing reference is lost under the criteria stipulated in ITU-T G.783.
- 5.3.6.5 The priority list and the synchronization source currently used by the equipment shall be retrievable.
- 5.3.6.6 The SDH equipment shall provide user-selection of synchronizing the outgoing STM signal in one of but not be limited to the following synchronization modes:
- (1) Internal Clock Mode; and
 - (2) Incoming STM to outgoing STM Signals.
- 5.3.6.7 When all incoming timing reference is lost, the equipment shall be capable of entering into Holdover Mode.

- 5.3.6.8 Synchronization network shall be protected against single transmission network node/link failure, that is, a single node/link failure shall not cause a complete loss of synchronization reference to any other transmission network node.
- 5.3.6.9 Engineering of the synchronization network plan shall ensure the normal functional operation and no voice performance degradation of the inter-telephone switch communication.
- 5.3.6.10 Automatic re-configuration of synchronization source shall not cause any interruption or generation of errors in any low speed and high speed signals being transported by the Network Element equipment.
- 5.3.6.11 Synchronization plan shall prevent repeated switchovers of synchronization sources automatically when intermittent/frequent failures occur in the clock sources(s).
- 5.3.6.12 The Network Element equipment shall provide manual switchover to a specific synchronization source irrespective of its priority in synchronization sources selection with password protection. Manual switchover to a failed synchronization source shall be prevented by the equipment.
- 5.3.6.13 Facilities shall be provided at the Network Element equipment to monitor the performance of the derived synchronization timing signals and report the corresponding alarm conditions to the NMS.
- 5.3.6.14 The Contractor shall submit the Synchronization Scheme which should also address issues of synchronization of SDH networks of CP-105, CP-104, CP-203, CTP-14 and STP-5.
- 5.3.7 Network Protection**
- 5.3.7.1 The SDH Equipment shall support Protection Mechanism such as Linear Multiplex Section Protection, Sub Network Connection Protection (SNCP), Multiplex Section Shared Protection Ring (MSSP Ring).
- 5.3.7.2 Path Protection implementation through SNCP is preferred. SNC Protection shall be provided at VC-4 and VC-12 level. Signal transmission shall be protected on a per path basis.
- 5.3.7.3 The normal and protected routes shall be routed through different Optical Fibre Cables with path diversity.
- 5.3.7.4 Automatic path protection switching shall occur upon detection of failure or alarm conditions which will affect the quality of signal transmission. The protection switching shall be completed within 50ms.
- 5.3.7.5 Manual Protection Switching facility shall be available. Manual Protection Switching shall be initiated by a switch command from the NMS. The protection switching shall be completed within 50ms.
- 5.3.7.6 Failure of any single SDH node shall not affect the operation of the remaining SDH nodes in the network. Fault in any single fibre cable section shall not affect the operation of any SDH node or Sub-systems data exchange. Alarm of the particular node shall be raised at the NMS.
- 5.3.7.7 The Flexible Access Multiplex Equipment shall be provided with 1+1 Redundancy for E1 Channels. Further 1+1 Protection for Control (if its failure results in affecting traffic) & Power Supply Modules/Cards shall be provided in Flexible Access Multiplex Equipment.
- 5.3.7.8 No single failure shall affect the availability of OFC System or the Interfaces.
- 5.3.7.9 The OFC System, under the fault conditions, shall remain in operation and automatically reconfigure, if necessary, without the need for control by the NMS.
- 5.3.8 Service Telephone / Order Wire**
- 5.3.8.1 A Service Telephone/Engineers Order Wire with handset shall be provided at each and every SDH Node locations for point-to-point and point-to-multipoint voice communication calls between maintenance staff at different SDH Node locations. It shall permit selective and group call functions.

5.3.8.2 The operation of Service Telephone/Engineers Order Wire shall not affect the operation of the signal transmission within the OFC System.

5.3.9 Network Management System

5.3.9.1 At the OCC, a Network Management System (NMS) shall be provided to carry out Real-time centralised and remote monitoring and measurement of network status and performance, and the ability to take prompt action to control the flow of traffic when necessary.

5.3.9.2 The equipment to be managed shall include SDH Equipment, Flexible Access Multiplexer or Primary Order Multiplexers and Optical Line Terminals, etc.

5.3.9.3 NMS Workstation shall be installed at the OCC in TER (or any other location as decided by the Engineer) for the operation of the NMS. If feasible, NMS being provided under Contract Package CP-104 shall be upgraded to meet the requirement under this Contract.

5.3.9.4 The NMS shall be equipped with spare ports for future additional Workstations and the ports shall allow remote connection through commercially available modems.

5.3.9.5 NMS workstation shall be equipped with a log printer for alarm and event print-out.

5.3.9.6 The NMS shall be equipped with mass storage device for storage of the configuration and alarm data-files.

5.3.9.7 The mass storage device shall provide facilities for downloading the configuration and alarm data files to CD/DVD/Pen Drive.

5.3.9.8 Laptop Portable Service Terminals (02 numbers) loaded with Network Management Software shall also be provided for maintenance access to the network elements at various node locations.

5.3.9.9 The NMS shall have an internal clock synchronised to the Master Clock for the time and date information. The internal clock shall allow free running in case of loss of signal from master clock.

5.3.9.10 The NMS shall provide Operations, Administration, Maintenance & Provisioning (OAM&P) functions in accordance with the Telecommunications Management Network (TMN) concept described in ITU-T Recommendations M-3010.

5.3.9.11 Alarm and Status Monitoring

- (1) The operational status and performance of all the network elements shall be monitored on a real time basis by the NMS. The status monitoring shall be down to the card level as a minimum.
- (2) The network elements shall have alarm logging facilities so that detailed history of the failure alarms can be retrieved either locally using the portable service terminal or remotely by the NMS.
- (3) Alarms to be collected from network elements shall include, but not be limited to the following:
 - (a) input failure;
 - (b) loss of frame alignment;
 - (c) high error rate alarm;
 - (d) loss of pointer;
 - (e) loss of synchronisation;
 - (f) out of frame alignment;
 - (g) alarm indication;
 - (h) high/low optical power;
 - (i) high laser bias;
 - (j) tributary unit failure;
 - (k) power unit failure;
 - (l) external synchronisation failure;
 - (m) mains power failure; and
 - (n) any card/ module failure.
- (4) Failure alarms shall be classified into user configurable major/ minor etc. alarms. All alarms and status changes shall be stored in local storage of network elements,

stored in mass storage device at OCC and output to the printer on demand. All alarms and status shall be stamped with time and date within an accuracy of 1 second.

- (5) Each alarm log shall include details on the type and nature of the fault, alarm category, fault location, date and time fault is detected and date and time the fault is cleared. An audible alarm shall be given at NMS workstation and shall be reset by maintenance staff on acknowledgement.
- (6) A local alarm indication for the network element shall be given and shall be reset automatically upon the alarm is cleared.
- (7) A summary alarm shall be provided at the rack top to indicate the alarm status of any element within the rack. The summary alarm shall be reset automatically upon the alarm is cleared.
- (8) The NMS shall provide function for user to enable and disable output of alarm events to the log printer.

5.3.9.12 Performance Monitoring

- (1) The NMS shall calculate, display and provide print-out of the performance statistics for the OFC system.
- (2) In-service performance monitoring for all network elements shall include, but not be limited to the following performance parameters:
 - (a) laser bias current;
 - (b) optical power transmitted;
 - (c) optical power received;
 - (d) degraded duration in minutes;
 - (e) severely error seconds;
 - (f) protection switching counts;
 - (g) protection switching duration;
 - (h) error seconds of the received E1 and above signals; signal level of the received E1 and above signals;
 - (i) error free seconds of the received E1 and above signals; and
 - (j) bit error rate of the received E1 and above signals.
- (3) Loss of power shall not cause any corruption or loss of data in the network elements and the NMS.
- (4) The in-service performance data files shall be able to be transferred to disk or any other storage media subject to review by the Engineer. The data files shall be in format to allow analysis using commercially available software.

5.3.9.13 Network Configuration and Provisioning

- (1) The Contractor shall provide a main and standby database for storing the system hardware and software configurations. Both the working and backup configuration data base shall be automatically and simultaneously updated for any changes in the data base.
- (2) The NMS shall allow the user to configure all existing and new circuits with the following functions:
 - (a) frame position allocation;
 - (b) interface port allocation;
 - (c) low speed (64 kbit/s & lower) interface cards configuration;
 - (d) lower order multiplex time slot allocation and routing;
 - (e) higher order multiplex/cross-connect switch configuration;
 - (f) logging of circuit routing data logged into configuration database; and
 - (g) operators configuration check function prior to main and backup database update.

5.3.9.14 User Interfaces

NMS functions shall be performed via a user-friendly graphical user interface (GUI) in real-time mode.

5.4 Performance Specification

5.4.1 General

5.4.1.1 In addition to what has been specified in Chapter 3 the following performance requirements for the OFC System shall be complied.

5.4.1.2 Fault tolerant design with protections against failure shall be provided in order to achieve the system availability. Protections shall include, but not be limited to path diversity, redundancy and duplication of reliability critical equipment, component and circuits.

5.4.2 Reliability

5.4.2.1 The inability to perform any required function, the occurrence of unexpected action or the degradation of performance below the specifications shall be considered as a failure.

5.4.2.2 The Contractor shall furnish for the following sub-systems/equipment, the reliability figures, MTBF Hours from the OEMs:

- (1) SDH Node Equipment
- (2) Flexible Access Multiplexer or Primary Order Multiplexer
- (3) Network Management System

5.4.3 Availability Requirements

5.4.3.1 The Contractor shall implement a RAMS Plan defined in accordance with IEC 62278. Any degraded mode of operation or re-configuration functions provided by the OFC System shall not be included in the determination of the system availability. The Contractor shall submit to the Engineer for review and consent the RAMS analysis for the OFC System to establish the requirements of availability specified here below.

5.4.3.2 The availability of OFC System at circuit level shall be defined as the availability of the circuit between both end points of the Optical Fibre Communication System Network where the required bandwidth is available for access. The equipment connected for the access for the circuit bandwidth shall be excluded from the availability calculation.

5.4.3.3 Any circuit of the OFC System shall be considered unavailable if;

- (1) there is a loss of communication between end points of the circuit; or
- (2) quality of the signal transmission within the circuit is below the performance standards stipulated in this Particular Specification.

5.4.3.4 The availability of any circuit at 2 Mbps level or higher within OFC system shall be better than 99.999%.

5.4.3.5 The availability of any circuits below 2 Mbps level shall be better than 99.995%.

5.4.3.6 The Network Management System shall be considered unavailable if any functions provided by the Network Management System cannot be properly exercised. The availability of the Network Management System shall be better than 99.5%.

5.4.4 Maintainability Requirements

5.4.4.1 The Contractor shall comply with the maintainability requirements as specified in Clause 3.4.

5.4.4.2 The service life of the OFC System (equipment) shall not be less than 15 years. Service life of all types of cables shall not be less than 25 years.

5.4.5 System Safety Requirements

5.4.5.1 In the event of a break in the optical fibre cable, the optical transmitter laser output shall shut down to a safe level as defined by IEC-60825, ITUT-G 958. The shutdown mechanism shall not be software dependent.

5.4.5.2 All equipment must comply with, and be installed in conformance with IEC 60065 and IEC 60364 or equivalent National Electric Code/Uniform Building Code of safety standards.

5.4.5.3 All metallic enclosures shall be provided with an earth terminal.

5.5 Technical Requirements

5.5.1 General

5.5.1.1 The Contractor shall submit the following information to the Engineer for review:

- (1) details on the specifications of each low speed data and voice channel interfaces below E1 level;
- (2) details on all the available data and voice channel interfaces that the Flexible/Primary Order Access Multiplexer can be equipped with and, the limitations;
- (3) details on the hardware modularity of each type of data and voice interface including the incremental number of interfaces that can be added to a partially equipped equipment shelf and limitations on the addition of the interfaces to the equipment already equipped with mixed types of interfaces shall be defined;
- (4) details on the electrical and physical specifications of the local maintenance port which support remote and local operation, administration, maintenance and provisioning (OAM&P) functions of the equipment;
- (5) the calculations of delay for signal transmission between SDH nodes;
- (6) optical link budget calculations for all the transmission links;
- (7) a list of alarms for which the faults shall be detected;
- (8) format in which alarms shall be displayed and remotely accessed for printing and display;
- (9) the details on the maximum number of tributary signal interfaces that can be supported by the SDH node and the limitations;
- (10) the details of the synchronisation network design and a synchronisation plan which describes the fall back arrangement, failure and restore criteria used to determine the switchover of synchronisation sources, the associated timings under each failure and restoration event and the method used in preventing repeated switchovers of synchronisation sources automatically when intermittent/frequent failure occur in the clock sources;
- (11) the details of the NMS design, flow of management traffic and protection against SDH node failures or cable failures;
- (12) types and maximum number of transmission equipment supported by the NMS;
- (13) self-healing mechanism, normal traffic flow diagrams, protected traffic flow details for various single and multiple cable(s) and/or node(s) failures; and
- (14) normal and protected bandwidth allocation, maximum traffic capacity and method of calculation for the SDH Network.

5.5.1.2 The Contractor shall estimate and provide the bandwidth needed in order to guarantee the level of service required by all the Sub-systems.

5.5.1.3 At least 50% Spare Traffic Bandwidth and capacity between nodes shall be provided for SDH Network and Primary Multiplexer Network. Spare capacity shall be achieved by providing additional cards and/or modules.

5.5.2 Technical System Performance

5.5.2.1 The OFC System shall conform to relevant ITU-T G-series Recommendation.

5.5.2.2 The jitter and wander performance shall conform to ITU-T Rec.G.823, and G.825, as applicable.

5.5.2.3 Voice Circuits shall have an end to end performance in accordance with ITU-T Rec. G.712.

5.5.2.4 Data circuits shall have an end to end error performance in accordance with the ITU-T Rec. G.821.

5.5.2.5 The maximum traffic interruption time for any required service bit rates due to link, node or any other failure shall be less than 50 ms. It shall include the duration for protection switch time completion with the sequence of events below:

- (1) from the onset of a failure detection to the completion of protection switching;
- (2) from the clearing of a failure to the completion of protection switching recovery (in case of reversion switching);
- (3) from the activation of the recovery command to the completion of protection switching recovery (in case of non-reversion switching); and

- (4) reframing time required by equipment including, but not be limited to, SDH equipment, flexible multiplexers, optical line terminal and data modem.
- 5.5.2.6 The absolute group delay, at the frequency of minimum group delay, shall not exceed the limit of 600 microseconds, as per ITU-T Recommendation, taking into account of the worst delay scenarios.
- 5.5.2.7 The system response times of the NMS shall be as follows:
- (1) commands presented to the NMS from Management Workstation shall be processed and produce an appropriate output within 2 seconds maximum;
 - (2) real-time data presented to the Management Workstation from the network elements shall be processed and produce the appropriate output within 2 seconds maximum; and
 - (3) execution of parameter changes to SDH Nodes initiated through the NMS shall be less than 2 seconds.
- 5.5.3 **Equipment Design Requirements**
- 5.5.3.1 **General**
- (1) The equipment design of OFC System shall be of standard rack with plug-in units. Hot swapping capability shall be provided for all cards/units including redundant power supplies. Hot-swapping of the plug-in units shall not affect the equipment operation.
 - (2) A summary alarm indication shall be provided at the top of each rack to indicate the summary alarm status of the equipment within the rack.
 - (3) Equipment shall be equipped with protected test points for measurement and performance monitoring without affecting the traffic.
 - (4) Test access facilities shall be provided at different transmission levels.
 - (5) Equipment shall be provided with natural cooling arrangement, however if natural cooling arrangements are not adequate, the use of fan shall be provided.
- 5.5.3.2 **SDH Equipment**
- (1) All SDH equipment shall conform and be compliant with ETSI 300 147 and relevant ITU-T Recommendations including of G.707 to G.709, G.781, G.783, G.784 and G.957.
 - (2) The SDH Nodes at OCC and New Boraki Station shall provide cross connect capabilities with a granularity of VC4, VC-3 and VC-12. These Nodes shall have Non-Blocking Cross connect with minimum capacity of 64X64 VC4 equivalents at VC4 level and 32X32 VC4 equivalents at VC3 and VC12 level.
 - (3) Each SDH Node shall be equipped with (1+1) redundant configuration at optical and electrical levels at STM-16(if applicable) and STM-4 level.
 - (4) The SDH Equipment shall operate satisfactorily at 48V±20% DC. The Contractor shall provide power supply equipment for power conversion if necessary. The equipment shall be capable of withstanding voltage spikes of up to 3 Volts over the maximum voltage.
- 5.5.3.3 **Flexible Access Multiplex Equipment**
- (1) Flexible Access Multiplex Equipment shall conform to ITU-T Rec. G.703, G.704, G.706, G.707, G.708, G.709, G.711, G.732 and G.823.
 - (2) Flexible Access Multiplex Equipment shall support Primary Multiplexing, Digital Branching and Digital Cross Connect.
 - (3) Flexible Access Multiplex Equipment shall support functionalities of Terminal Multiplexer, Protected Terminal Multiplexer, Drop/Insert Multiplexer, Bypass Multiplexer and Loop Protected Multiplexer.
 - (4) Flexible Access Multiplex Equipment shall support Omnibus Operation of Voice in Data Channels.
 - (5) Flexible Access Multiplex Equipment shall have in-built feature to provide details of performance data like AS, ES, SES, DM, etc. via NMS or via Laptop Service Terminal.

- (6) Adequate numbers of Primary Multiplexers shall be provided so that there is no loss of Communication at any point of time.
- (7) Flexible access multiplexer equipment shall be provided with 1+1 protection for all channel levels (VF, Data, etc.) with automatic switch over in case of fault.
- (8) The optical line interfaces shall conform to ITU-T Rec. G.957.
- (9) Flexible Access Multiplex Equipment shall operate satisfactorily with 48V DC Battery Backup System being provided under this Contract. The Contractor shall provide power supply equipment for power conversion if necessary. The equipment shall be capable of withstanding voltage spikes of up to 3 Volts over the maximum voltage.
- (10) Channel Interfaces
 - (a) Where required, the Flexible Access Multiplex Equipment shall provide voice frequency interfaces for analogue telephone sets located not at the switch site, including but not be limited to the following, subject to the Review by the Engineer:
 - voice interface selectable on two or four wires E&M signalling conforming to ITU-T Rec. G.712 respectively;
 - voice interface microphone current feeding, subscriber loop signalling, on hook/off hook detection, ring trip and ringing current provision;
 - Voice interface providing voice line connection to Extensions (FXS Interface) & PBX (FXO Interface); and
 - any other voice interfaces required for other Subsystems/ designated contractors.
 - (b) The Contractor shall determine and provide appropriate types and quantities of channel interfaces based on the requirements of the Subsystems.
 - (c) The Contractor shall submit the details of all the channel interfaces which can be supported by the Flexible Access Multiplexer or The Primary Order Multiplexer.
 - (d) The voice interface shall be Pulse Code Modulated (PCM) in A-law as described in ITU-T Rec. G.711.
 - (e) The Flexible Access Multiplex Equipment shall provide, as required, data interfaces, including but not be limited to the following, subject to the review by Engineer:
 - 0-19.2kbps synchronous or asynchronous data complying with ITU-T Rec. V.11 (EIA RS-422 or RS-485) interface etc.;
 - asynchronous/synchronous full duplex data transmission complying with EIA/TIA-232-E and V.28 standard;
 - 64 kbps synchronous data interfaces complying with ITU-T Rec. G.703 unbalance interface;
 - nx64 kbps synchronous data interfaces complying with ITU-T Rec. V.11 and V.35 interface;
 - ISDN Basic Rate Interface with 2B+D channels as defined in ITU-T Rec. I.430;
 - Primary Rate Interface complying with ITU-T Rec. I.431 interface at 2.048 Mbps (30B+D); and
 - Any other data interfaces required for other Subsystems.

5.5.3.4 **Network Management System Specifications**

- (1) The NMS shall provide Operations, Administration, Maintenance & Provisioning (OAM&P) functions in accordance with the Telecommunications Management Network (TMN) concept described in ITU-T Recommendations M-3010.
- (2) The NMS shall have provision to monitor network performance in accordance with ITU-T Rec. G.831.
- (3) The NMS shall be equipped with a proven real-time, multi-tasking operating system to support centralised network management of SDH and PDH equipment from OCC.

- (4) The operating system shall conform to ITU-T Rec. G.774 SDH informational model in managing the equipment. The operating system shall provide a versatile environment with automatic boot strap function for re-initialisation after a power interruption.
- (5) The NMS shall support Q Interface conforming to ITU-T Rec.G.732, Q.811 & Q.812, Qecc. Interface as per ITU-T Rec.G.784 and F interface of V.24/V.28 type.
- (6) Each Management Terminal shall be equipped with 24 inch colour LED backlit VDU to provide graphical representation and display of the network. A log printer shall be provided.
- (7) The mass storage device shall provide storage capacity for at least one month configuration and alarm data.
- (8) Each portable service terminal shall be powered by an internal rechargeable battery with more than 4 hours normal continuous time without recharging

5.5.3.5 **Cabling and Accessories**

- (1) Optical fibre cables shall be supplied as per RDSO specification no. IRS: TC 55-2006 with Latest Amendments from RDSO approved sources.
- (2) The Optical Fibre Connectors shall comply with IEC60793 and IEC60874.
- (3) The requirements on cabling accessories, digital distribution frames, optical distribution frames, main distribution frames are as given in Chapter-14 of this Particular Specification.

5.5.4 **System Expansion**

- 5.5.4.1 The OFC System shall be equipped with sufficient capacities and margins such that the System can operate properly under peak load or traffic conditions.
- 5.5.4.2 It shall be possible to insert additional SDH Nodes into the OFC Network without affecting the performance of the Network, limits on this, if any, shall be specified by the Contractor for review by the Engineer.
- 5.5.4.3 The OFC System shall be compatible with SDH Equipment from other manufacturers.
- 5.5.4.4 The NMS for OFC System shall be designed and equipped with all necessary hardware, software and capacity for future additional SDH Equipment and associated Flexible Access Multiplexer and Channel Interfaces.

*** End of Chapter 5 ***

CHAPTER 6 - DATA NETWORKING SYSTEM

6.1 General

- 6.1.1 An extensive Data Networking System shall be provided for meeting the Packet Data Communications requirements of Dadri-Khurja section of EDFC. Data Networking System which is a Wide Area Network (WAN), shall, inter-alia, cover OCC, New Boraki Station, TSS, and IMSD.
- 6.1.2 The Wide Area Network (WAN) shall provide sufficient bandwidth to cater for the Packet Data Communications requirements of various Sub-systems under this Contract as well as outside this Contract. This Wide Area Network (WAN) shall also provide sufficient bandwidth to cater for the Packet Data Communications requirements of Khurja – Dadri section of EDFC for other applications such as Freight Operation Information System (FOIS), Crew Management System (CMS) and Wagon Management System (WMS).
- 6.1.3 All Vital & Safety Related System using Data Networking System shall be implemented as per EN-50159.
- 6.1.4 Wide Area Network (WAN) shall be a highly reliable system since it shall be the primary means of Packet Data Communications between various locations mentioned above. The System Design shall be highly resilient to Common Mode Failure with least recovery time and shall provide High Performance under normal operation as well as under worst case Network Loading.
- 6.1.5 Wide Area Network (WAN) shall be created using Layer-3 Switches and Layer 2 switches operating on Optic Fibre Cables laid along UP &DN tracks of EDFC.
- 6.1.6 Wide Area Network (WAN) shall be integrated with Wide Area Network (WAN) provided under Contract Packages CP-104 & CP-203 of EDFC and Wide Area Network provided under Contract Packages STP-5, STP-17 and CTP-14 of WDFC to meet the requirement of this Particular Specification.
- 6.1.7 WAN shall comply with internationally recognised Industry Standards & Open System Protocols. The Design of Wide Area Network (WAN) shall provide a highly Secure System, which shall prevent unauthorised Access and/or Hostile Intrusion.
- 6.1.8 Ethernet Services such as Ethernet Private Line (EPL) Services, Ethernet Virtual Private Line (EVPL) Services and Ethernet Local Area Network (E-LAN) shall be extended to Auto Location Huts, GSM-R Locations, & SSPs using EoS (Ethernet over SDH) of OFC System for meeting the requirements of other Sub-systems within this Contract as well as outside this Contract as approved by Engineer.
- 6.1.9 At New Boraki Station Wi-Fi Facility, compliant with IEEE 802.11g Standards shall be provided for WAN Connectivity to users (which also include drivers of passing trains) via Wireless Enabled Devices and Equipment. A minimum of 10 simultaneous users may use the Wi-Fi Connectivity at Station. This Wi-Fi Facility shall as a minimum cover Station Building and EDFC Tracks up to 500 meters in both directions.
- 6.1.10 Network Management System(NMS) for Data Networking System to be provided at OCC shall facilitate configuration, administration, monitoring & troubleshooting of the data networking system. If feasible, Contractor may upgrade/augment NMS provided under Contract Package CP-104 to meet the requirements of this Particular Specification. .
- 6.1.11 Structured Cabling for Data Networking System shall be within the scope of work under this Contract.
- 6.1.12 Whenever existing equipment provided under Contract Packages CP-104 & CP-203 are upgraded/augmented to meet the requirement of this Particular Specifications, the available provision for redundancy in existing equipment shall not be compromised and subsequent to upgradation/augmentation they shall meet the Technical Requirement and Performance Requirement as stipulated in this Particular Specifications.

6.2 Scope of Supply for Data Networking System

The scope of supply shall include, but not be limited to, the following:

- (1) Layer-3 Switches;
- (2) Layer-2 Switches;
- (3) Wi-Fi Access Equipment;
- (4) Distribution Frames;
- (5) Terminating and interconnecting equipment/panels;
- (6) Equipment cabinets, racks and cubicles;
- (7) All type of cables and cords;
- (8) All required connectors;
- (9) Installation materials;
- (10) Network Management System;
- (11) Earthing and accessories including termination protection devices;

6.3 System Requirements

- 6.3.1 WAN shall be created using Layer-3 Switches equipped with minimum 4 Nos. of 10GigE Fibre Ports for backbone interconnections. WAN shall connect OCC, New Boraki Station, TSS and IMSD using Optic Fibre Cable. Further WAN shall connect TSS with New Boraki Station in Redundant Linear Topology using Optical Fibre Cable. Locations of Layer-3 Switches can be clubbed based upon design of other Systems/Subsystems under this Contract while meeting overall Packet Data Communication Requirements.
- 6.3.2 Layer-3 Switches at New Boraki shall be integrated with Layer-3 Switches being provided at New Khurja Station under Contract Package CP-104 using 10GigE Fibre Ports with 1+1 Protection or by extending the existing Ring of Contract Package CP-104.
- 6.3.3 Layer-3 Switches at New Boraki shall be integrated with Layer-3 Switches being provided at New Dadri Station under Contract Package CTP-14 using 10GigE Fibre Ports with 1+1 Protection. CTP-14 and CP-105 Contractors shall interface with each other and submit jointly, agreed integrated design of Data Network for approval of Engineer.
- 6.3.4 Layer-3 Switches at OCC shall be integrated with Layer-3 Switches at OCC being provided under contract Packages CP-104 & CP-203 using 10GigE Fibre Ports with 1+1 Protection. If feasible existing Layer-3 switch provided under Contract Package CP-104 may be upgraded/augmented to meet the requirements of this Particular Specification.
- 6.3.5 Each Layer-3 Switch Site shall employ, as necessary, Multi-layer Switching comprising a combination of Layer-2 Switching and Layer-3 Protocol Routing. Layer-2 Switch shall be deployed as per Site Requirements. Network Topology and Connectivity Plan shall be submitted as part of Design to the Engineer for approval.
- 6.3.6 Layer-3 Switch shall be provided, in fully duplicated configuration, at each site in (1+1) Hot-Standby Configuration.
- 6.3.7 Layer-3 Switches at New Boraki shall be equipped with additional 2 Nos. 10GigE Fibre Ports.
- 6.3.8 WAN shall be of highly Scalable Design, whilst maintaining Throughput, Quality of Service and Security.
- 6.3.9 Ethernet Services such as Ethernet Private Line (EPL) Services, Ethernet Virtual Private Line (EVPL) Services, Ethernet Local Area Network (E-LAN) Services, Layer2 Protocol Tunnelling (L2PT), Virtual Private Wire Service (VPWS) & Ethernet over MPLS (EoMPLS) shall be available on WAN.
- 6.3.10 Ethernet Services such as EPL, EVPL & E-LAN shall be extended to Auto Location Huts, GSM-R Locations & SSPs using EoS (Ethernet over SDH) of OFC System.
- 6.3.11 EPL, EVPL, E-LAN, L2PT and VPWS Services of Dadri-Khurja Section which are to be carried to OCC, shall be carried to OCC using QinQ. EPL, EVPL, E-LAN, L2PT and VPWS Services, which are required to be provided across Dadri-Khurja, EDFC Phase-1 & EDFC

Phase-2, shall be implemented by the Contractor. Contractor shall submit integrated design for approval of Engineer.

- 6.3.12 Layer-3 Services such as IPv4 Routing, IPv6 Routing, Border Gateway Protocol (BGP), Intermediate System-to-Intermediate System (IS-IS), Open Shortest Path First (OSPF), Virtual Router Redundancy Protocol (VRRP), Multi-Protocol Label Switching, Label Distribution Protocol (LDP), Targeted LDP(T-LDP), Primary & Secondary Label Switched Paths, MPLS L3 VPN, Resource Reservation Protocol (RSVP), MPLS Traffic Engineering (including TE-FRR), Routed Pseudo wire, IP-VPN (RFC 2547/4364) and Integrated Routing & Bridging shall be available on the WAN. These services shall be implemented to cater for the communication requirements of various Sub-systems under this Contract as well as outside this Contract.
- 6.3.13 Layer-3 Services of Dadri–Khurja Section which are to be carried to OCC, shall be implemented over WAN being provided under this Contract and, if required, over WAN being provided under Contract Packages CP-104 and CP-203.
- 6.3.14 Layer-3 Services IPv4 Routing, IPv6 Routing, BGP, IS-IS, OSPF, VRRP, MPLS, LDP, T-LDP, Primary & Secondary Label Switched Paths, MPLS L3 VPN, RSVP, MPLS Traffic Engineering (including TE-FRR), Routed Pseudo wire, IP-VPN (RFC 2547) and Integrated Routing & Bridging which are required to be provided across Dadri-Khurja Section, EDFC Phase-1 & EDFC Phase-2 shall be implemented by the Contractor.
- 6.3.15 Quality of Service (QoS) features such as Ingress & Egress Marking, Ingress & Egress Policing, Priority Queuing, Class-Based Queuing, WRED, Scheduling and Access Control List shall be available on the WAN.
- 6.3.16 Multicast protocols such as Internet Group Management Protocol (IGMP)/Protocol Independent Multicast (PIM) and Multicast Source Discovery Protocol (MSDP) shall be available on the WAN.
- 6.3.17 Wide Area Network (WAN) should support IPv4 and IPv6 Protocols. It shall support Static as well as Dynamic Host Configuration Protocol (DHCP) based IP Address Management.
- 6.3.18 Security features such as Authentication, Authorization & Accounting (AAA), Secure Shell Protocol (SSH), MAC Limiting per Ethernet Flow-point, Unicast/ Multicast/ Broadcast Storm Control Blocking, Layer-2 ACL, Layer-3 ACLs for IPv4 & IPv6 and DHCP Snooping shall be available on the WAN.
- 6.3.19 Operations, Administration & Maintenance features such as CFM OAM (IEEE 802.1ag), EFM OAM (IEEE802.3ah), MPLS OAM and OAM Functions & Features as per ITU-T Y.1731 shall be available on WAN.
- 6.3.20 Network Management System shall be provided for WAN. This Graphic User Interface(GUI) based NMS shall have a complete Data Network, so as to provide the necessary control, supervision, maintenance, configuration and performance management. This NMS shall support Layer-2 & Layer-3 Services. This NMS should support following minimum features:
- (1) Fault Management & Analysis;
 - (2) GUI & Service Template based Configuration & Provisioning;
 - (3) Composite L2/L3 Service Creation & Management;
 - (4) Performance Statistics collection and management;
 - (5) Security Management;
 - (6) OAM Testing;
 - (7) Troubleshooting and Assurance;
 - (8) Historical and real-time path monitoring;
 - (9) Path computation for Network Planning/Traffic Engineering tool integration.

If feasible Network Management System provided under Contract Package CP-104 may be upgraded/augmented to meet the requirements of this Particular Specification.

6.4 Performance Requirement

6.4.1 General

The following performance requirements for Data Networking System shall be fully complied. This shall be based on fault tolerant design with protections against failure in order to achieve the system availability.

6.4.2 Reliability

6.4.2.1 The inability to perform any required function, the occurrence of unexpected action or the degradation of performance below the specifications shall be considered as a failure.

6.4.2.2 The Contractor shall furnish for the Layer-3 Switch and Layer-2 Switch, the reliability figures such as MTBF in years from the OEMs.

6.4.3 Availability Requirements

6.4.3.1 The Contractor shall implement a RAMS Plan defined in accordance with IEC 62278. Any degraded mode of operation or re-configuration functions provided by the Data Networking System shall not be included in the determination of the system availability. Contractor shall submit to the Engineer for review and consent the RAMS analysis for the Data Networking System to establish the requirements of availability specified here below.

6.4.3.2 The availability of Data Networking System shall be defined as the availability of the bandwidth between end points of the Data Networking System. The equipment connected for the access for the bandwidth shall be excluded from the availability calculation. The availability Data Networking System shall be better than 99.999%.

6.4.3.3 To improve the availability of Data Networking System various measure such as Resilient Ethernet Protocol, Pseudo wire Redundancy, Link Aggregation (IEEE 802.3ad) on Network/Access Ports, Rapid Spanning Tree Protocol (IEEE 802.1w), Multiple Spanning Tree Protocol (IEEE 802.1s), MPLS-TE Fast Reroute etc. as required shall be implemented.

6.4.3.4 The Network Management System shall be considered unavailable if any functions provided by the Network Management System cannot be properly exercised. The availability of the Network Management System shall be better than 99.5%.

6.4.4 Maintainability Requirements

6.4.4.1 The Contractor shall comply with the maintainability requirements as specified in Clause 3.4 of this Particular Specification.

6.4.4.2 The service life of the Data Networking System (equipment) shall not be less than 15 years.

6.4.5 System Safety Requirements

6.4.5.1 In the event of a break in the optical fibre cable, the optical transmitter laser output shall shut down to a safe level as defined by IEC60825, ITU-T G.783, and ITU-T G.798. The shutdown mechanism shall not be software dependent.

6.4.5.2 All equipment must comply with, and be installed in conformance with IEC 60065 and IEC 60364 or equivalent National Electric Code/Uniform Building Code of safety standards.

6.4.5.3 Switch shall conform to IEC 60950-1 Standards for safety requirements of IT Equipment.

6.4.5.4 All metallic enclosures shall be provided with an earth terminal

6.5 Technical Requirements

6.5.1 Layer-3 Switches : Layer-3 Switches of WAN should meet following minimum technical requirements:

6.5.1.1 Layer-3 Switches of WAN shall have 24 Nos. 10/100/1000 Base-T Auto Sensing Ports with RJ 45 Connectors, 4 Nos. 100/1000 Base-X ports for SFP complying with IEEE 802.3, IEEE 803.3u and 802.3ab standard, supporting Half Duplex, Full duplex and Auto-Negotiation on each port to optimize bandwidth.

6.5.1.2 Layer-3 Switches shall have minimum of 28 Gbps forwarding bandwidth at Layer-2 and Layer-3 Switching Fabric, a minimum of 8000 MAC address space and 32 million packets (64 Byte packets) per second forwarding rate.

- 6.5.1.3 Layer-3 Switches shall be capable of working with DC Power Supply with range of -40 to -54V. Power Supply Module shall be redundant and inbuilt in the switch.
- 6.5.1.4 All the Layer-3 Switches shall be mounted on a 19-Inch Rack. All accessories required for this mounting shall be supplied by the Contractor.
- 6.5.1.5 All Software/Hardware/License supplied along with the Layer-3 Switches shall be supplied to the Engineer.
- 6.5.1.6 Layer-3 Switches shall support features such as Link Aggregation Control (as per IEEE 802.3ad), VLAN on all Ports (IEEE 802.1Q), VLAN Tagging (IEEE 802.1q), Minimum 256 VLANs, Port-Based Authentication (IEEE 802.1x), Spanning Tree Protocol (IEEE 802.1d), Multiple Spanning Tree Protocol (IEEE 802.1s), Rapid Spanning Tree Protocol (IEEE 802.1w), Dynamic Host Configuration Protocol (DHCP), Inter VLAN IP Routing for Layer-3 Routing, IPv6 Routing, Strict Priority Queuing, RADIUS Protocol for console access restriction and authentication as per RFC 2138 and Basic IP Unicast Routing Protocols.
- 6.5.1.7 Layer-3 Switches shall support multiple privilege level to provide different level of access on console port and telnet sessions.
- 6.5.1.8 Switches shall support Online Software Reconfiguration to implement changes without rebooting.
- 6.5.1.9 Layer-3 Switches shall have console port with a RS-232/RJ-45 Interface for configuration and diagnostics purposes.
- 6.5.1.10 Layer-3 Switches shall support Telnet, SNMP (Simple Network Management Protocol) V1/V2/V3, Network Time Protocol, SSH (Secure Shell) V1/V2 and FTP (File Transfer Protocol).
- 6.5.2 **Layer-2 Access Switch:** Layer-2 Access Switches shall meet the following minimum technical requirements:
- 6.5.2.1 Layer-2 Switches of WAN shall have 24 Nos. 10/100 Base-T Auto Sensing Ports with RJ 45 Connectors, complying with IEEE 802.3, IEEE 803.3u and 802.3ab standard, supporting half duplex, full duplex and Auto-Negotiation on each port to optimize bandwidth.
- 6.5.2.2 Layer-2 Switches shall have minimum of 16 Gbps forwarding bandwidth at Layer-2 Switching Fabric, a minimum of 1,000 MAC address space and 6 million packets (64 Byte packets) per second forwarding rate.
- 6.5.2.3 Layer-2 Switches shall be capable of working with DC Power Supply with range of -40 to -54V. Power Supply Module shall be redundant and inbuilt into the switch.
- 6.5.2.4 All the Layer-2 Switches shall be mounted on a 19-Inch Rack. All accessories required for this mounting shall be supplied by the Contractor.
- 6.5.2.5 All Software/Hardware/License supplied along with the Layer-2 Switches shall be supplied to the Engineer.
- 6.5.2.6 Layer-2 Switches shall support features such as VLAN on all Ports (IEEE 802.1Q), VLAN Tagging (IEEE 802.1q) and Minimum 256 VLANs. It shall support centralized VLAN Management, so that VLANs created on the Layer-3 Switches shall be propagated to all other switches automatically.
- 6.5.2.7 Layer-2 Switches shall support features such as Link Aggregation Control (as per IEEE 802.3ad), Port-Based Authentication (IEEE 802.1x), Spanning Tree Protocol (IEEE 802.1d), Multiple Spanning Tree Protocol (IEEE 802.1s), Rapid Spanning Tree Protocol (IEEE 802.1w), Dynamic Host Configuration Protocol (DHCP), RADIUS Protocol for console access restriction and authentication as per RFC 2138 and Classification and Scheduling on all ports (IEEE 802.1p).
- 6.5.2.8 Layer-2 Switches shall Support multiple privilege level to provide different level of access on console port and telnet sessions.
- 6.5.2.9 Switches shall support Online Software Reconfiguration to implement changes without rebooting.

6.5.2.10 Layer-2 Switches shall support Telnet, SNMP (Simple Network Management Protocol) V1/V2/V3, Network Time Protocol, SSH (Secure Shell) V1/V2 and FTP (File Transfer Protocol).

6.5.2.11 Layer-2 Switches shall have console port with a RS-232/RJ45 Interface for configuration and diagnostics purposes.

6.6 Security

6.6.1 Access Control Mechanisms shall be employed via Authentication, Authorization, and Cryptographic Key Validation, in accordance with IEEE 802.1X, to restrict WAN Access to Authorized Users only. Facilities shall be provided to ensure that the Confidentiality and Integrity of the Data Flows for the WAN cannot be compromised by, for example, Eavesdropping, or Interception and Content Modification.

6.6.2 WAN shall be protected against Malicious Activities on the Networks, including Attacks from Viruses, Denial of Services (DoS), Hacking, Hijacking, Spoofing and other Malicious Events that may compromise the Integrity of the Networks. Such Attacks shall include Sources within as well as outside the WAN.

6.6.3 Network Perimeter Firewall shall be provided to protect WAN against above Malicious Activities/Events from outside the WAN.

6.6.4 The Security Features for Connectivity and Access Control shall include Access Control Lists (ACLs), Authentication, Port-level Security and Identity-based Network Services.

6.6.5 Port Mirroring for Traffic Diagnostics shall be available.

6.6.6 It shall be possible to set individual Levels of Access Rights & Permissions for each User in order to control the Integrity of the Network itself and any Information contained in the Network.

6.6.7 The Contractor shall perform Security Analysis of WAN to demonstrate that all above Network Security Threats has been considered and mitigated.

6.6.8 The Contractor shall get its report on security analysis of data network examined from Cyber Security Expert/Agency approved by the Engineer. The suggestions/recommendations of this Cyber security Expert/agency shall be implemented by the Contractor.

6.6.9 A 'Global Security Plan' shall be recommended for the WAN including the Procedures to be adopted by the Employer and with the details of the Elements within that Plan.

6.7 Network Resilience and Protection

6.7.1 The Data Networking System shall include, to the extent necessary, the following facilities within the Core Elements of the Design to ensure the requisite Availability of Data Networking System:

- (1) Redundant Hardware;
- (2) Redundant Network Connections.
- (3) Circuit Redundancy & Path Diversity;
- (4) No Single Point of Failure.
- (5) Recovery from Network Failures
- (6) Hot-swap Capability.
- (7) Facility for Upgrade of Software & Firmware without any loss of Service.

6.7.2 The WAN System shall remain in Operation and automatically re-configure, if necessary, without the need for Control by the Network Management System, under the fault conditions.

6.7.3 The WAN System shall provide suitable Mechanisms for graceful restart and also for graceful degradation, in which the System shall provide lessened utility or effectiveness in the presence of a Fault, but still manage to provide some Service.

6.8 Network Management System

- 6.8.1 The Contractor shall provide at each Site, the Local Access to Maintenance Staff to the necessary NMS Functions via a Laptop/Engineer's Terminal, equipped with appropriate NMS Software.
- 6.8.2 Network Management System shall communicate with elements of WAN over SNMP (Simple Network Management Protocol) V1/V2/V3.
- 6.8.3 The Work Station for NMS at OCC shall include high quality colour printing facilities for report generation.
- 6.9 Structured Cabling**
- 6.9.1 All the Data Circuits from the Switches shall be terminated at the Patch Panel(s) inside the TER for distribution of the internal and external lines and interface with relevant Sub-systems and Project Contractors. All patch panels shall be equipped with proper cable management hardware for neat installation of the cables.
- 6.9.2 Standard RJ-45 modular socket shall be provided for termination of the Data Circuits for End Users via plug and socket arrangement.
- 6.9.3 CAT-6e cables shall be used for connection between Patch Panel(s) inside TER to the Standard RJ-45 modular socket.
- 6.9.4 Short circuit and over voltage protection device shall be provided to protect circuits from faults occurring in all outdoor cables.
- 6.10 System Expansion**
- 6.10.1 Wherever the equipment of Data Networking System being provided under Contract Package CP-104 and CP- 203 is being upgraded/augmented/reconfigured, this upgradation/augmentation/reconfiguration shall not in any way utilize available provision of expansion.

*** End of Chapter 6 ***

CHAPTER 7 - TELEPHONE SYSTEM

7.1 General

- 7.1.1 The Telephone System shall provide voice communications between locations equipped with telephone consoles/sets within the DFCCIL premises and other defined locations.
- 7.1.2 The Telephone System shall comprise of Administrative Telephone Network, Direct Line Telephone (DLT) Network, Control Communication System and Emergency Communication System.
- 7.1.3 Administrative Telephone Network and Direct Line Telephone Network shall be based upon Private Branch Exchange (PBX) for the operation, maintenance and administrative staff to set up voice communication.
- 7.1.4 Administrative Telephone Network shall be integrated with Administrative Telephone Network provided under Contract Packages CP-104 & CP-203 and EPABX Network provided under Contract Packages STP-5, STP-17 and CTP-14 to meet the requirement of this Particular Specification.
- 7.1.5 Direct Line Telephone Network shall be integrated with Direct Line Telephone Network provided under Contract Packages CP-104 & CP-203 and Dispatch Telephone System provided under Contract Packages STP-5, STP-17 and CTP-14 to meet the requirement of this Particular Specification.
- 7.1.6 Control Communication System shall be provided to meet omnibus voice communication requirement of Traffic Control between OCC and Stations.
- 7.1.7 Emergency Communication System shall provide an omnibus communication channel between OCC and all Automatic Signals.
- 7.1.8 Whenever existing equipment provided under Contract Packages CP-104 & CP-203 are upgraded/augmented to meet the requirement of this Particular Specifications, the available provision for Redundancy in existing equipment shall not be compromised and subsequent to upgradation/augmentation they shall meet the Technical Requirement and Performance Requirement as stipulated in this Particular Specifications.

7.2 Scope of Supply

The Scope of Supply for the Telephone System shall include, but not be limited to the following:

- (1) PBX Switches;
- (2) IP Telephony Server;
- (3) Media Gateways;
- (4) Line and Trunk Interfaces;
- (5) Direct Line Consoles;
- (6) Telephone Sets;
- (7) Voice Mail System;
- (8) Telephone Network Management System;
- (9) Voice Recording System;
- (10) Control Communication Equipments;
- (11) Emergency Communication Equipments;
- (12) Power Supply Equipment, Cables and Accessories; and
- (13) Distribution Frames, Cabinets, Enclosures, Racks, etc.

7.3 System Requirement

- 7.3.1 A highly reliable main and satellite PBXs based Telephone Network shall be installed and commissioned to provide TDM Communications Platform amongst telephone consoles/sets. Main PBX shall be provided at OCC, while Satellite PBX shall be provided at New Boraki Station. This Network of Main PBX and Satellite PBX shall be created using 2 Mbps E1 Channels over SDH Network as covered in Chapter-5 of this Particular Specifications. If feasible Contractor may upgrade/augment Main PBX provided at OCC under Contract Package CP-104 to meet the requirements of this Particular Specification.

7.3.2 In addition to PBXs based TDM Telephone Network, IP Telephony Server (Call Server) shall be provided at OCC to provide VOIP based backup Telephony Communication Platform. Media Gateway shall be provided as required to meet the requirement of this Particular Specification. If feasible Contractor may upgrade/augment IP Telephony Server and Media Gateway provided at OCC under Contract Package CP-104 to meet the requirements of this Particular Specification.

7.3.3 The IP Telephony Server shall also have connections with PBX at OCC and New Boraki Station over Wide Area Network (WAN) as covered in Chapter-6 of this Particular Specification. In case of failure of E1 link(s) between PBXs, all calls shall be routed via IP Telephony Server using IP Link(s) over WAN as an alternate route, without requirement of any manual intervention.

7.3.4 The PBXs shall have connection to the Public Switched Telephone Network (PSTN). This shall allow pre-selected extensions to access the PSTN or vice versa.

7.3.5 Administrative Telephone Network:

7.3.5.1 Administrative Telephone Network shall provide voice communication between OCC, Stations, Auto Location Huts, Interfacing IR Station, GSM-R Locations, TSS, SSPs, IMSD and Residential Quarters. Approximate requirements of Telephone Sets, which include Analogue Telephones as well as Digital Telephones, are as given in Table below:

SN	PBX Switch Location	Telephone Sets					Total PBX Telephones*
		Station Building	Nearby Residential Colonies	Nearby IMD or IMSD	Nearby Service Buildings	Nearby IR Stations	
1	New Boraki	20	50	10	10	10	100
2	OCC						32

*The requirement of Telephone Sets at individual location may vary. Exact requirement will be identified during Design Stage.

7.3.5.2 Administrative Telephones to be provided shall be Digital Telephones at OCC (8 Nos.) and at New Boraki Station (8 Nos.). All the remaining telephones shall be Analogue Telephones.

7.3.5.3 In addition to above, 2(Two) IP Video Phones shall be provided at OCC and 1(one) IP Video Phone shall be provided at New Boraki Station.

7.3.5.4 The telephones at OCC and New Boraki Station shall be directly terminated at PBX, while telephones at locations other than New Boraki Station shall be either directly terminated at PBX (if feasible) or connected to the PBX via the OFC System.

7.3.5.5 The Contractor shall discuss with the Engineer to agree on the exact location of each Telephone Set and IP Video Phone.

7.3.5.6 The Administrative Telephone Network shall provide feature transparency across all the PBXs. The following PBX features shall be provided:

(1)	Automatic Call Back;	(2)	Busy Hunt;
(3)	Break-In;	(4)	Call Forward;
(5)	Call Park;	(6)	Call Party Name & Number
(7)	Voice Mail	(8)	Call Transfer;
(9)	Call Waiting;	(10)	Conference Call;
(11)	Hot Line;	(12)	Abbreviated Dialling;
(13)	Access Paging;	(14)	Attendant Recall;
(15)	Alternative Route Selection;	(16)	Last Number Redial;
(17)	Line Lockout;	(18)	Malicious Call Trace;
(19)	Recorded Announcement;	(20)	Direct Inward Dialling (DID);
(21)	Direct Outward Dialling	(22)	Distinctive Ringing;
(23)	Forced Release;	(24)	Music on Hold;
(25)	Speed Dial;		

- 7.3.5.7 The assignment of the class of service and features to any telephone extension shall be configurable.
- 7.3.5.8 The Administrative Telephone Network shall support closed homogeneous numbering plan across the network such that the user has to just dial the extension number of the user, he wishes to reach from anywhere in the network. Further this numbering plan shall also be homogenous with numbering scheme adopted for EDFC under Contract Packages CP-104 & CP-203 and WDFC under Contract Packages STP-5, STP-17 and CTP-14. The numbering plan shall be discussed with Engineer and implemented only after it is reviewed by Engineer.
- 7.3.5.9 The Administrative Telephone Network shall support a minimum of the following four levels of programmable restrictions to each telephone extension:
- (1) totally restricted level in which user cannot make or receive calls to and from the PSTN through the telephone extension;
 - (2) semi-restricted level in which user cannot make PSTN calls but can receive PSTN calls through Direct Inward Dialling(DID);
 - (3) local level in which the telephone extension user can make or receive local PSTN calls only; and
 - (4) unrestricted level in which there shall be no restriction on the telephone extension for call connection.
- 7.3.5.10 Analogue Telephone Sets to be provided for Administrative Telephone Network shall be equipped with following facilities:
- (1) Handset;
 - (2) 12 Push-button DTMF Keypad;
 - (3) On-hook Dialling function;
 - (4) Display Unit showing Calling and Caller's extension number for Incoming and Outgoing Calls;
 - (5) 4 Feature Buttons for Redial, Hook-Flash, Mute and Hold;
 - (6) Hand-Free operation through built-in speaker and microphone; and
 - (7) Powered by the PBX.
- 7.3.5.11 Digital Telephone Sets to be provided for Administrative Telephone Network shall be equipped with following facilities:
- (1) Handset;
 - (2) 12 Push-button DTMF keypad;
 - (3) On-hook Dialling function;
 - (4) Display Unit showing Calling and Caller's extension number for Incoming and Outgoing Calls;
 - (5) Ringing Signal Lamp;
 - (6) Voice Mail Message Lamp;
 - (7) Hand-Free operation through built-in speaker and microphone;
 - (8) Adjustable volume control for speaker and ringer;
 - (9) A minimum of 10 programmable function keys for flexible assignment for; system features or additional extension circuits
 - (10) Display of call duration;
 - (11) System Clock Display;
 - (12) A minimum of 20 Memories for speed dialling; and
 - (13) Powered by the PBX.
- 7.3.5.12 IP Video Phones to be provided for Administrative Telephone Network shall be equipped with following facilities:
- (1) Handset
 - (2) On-hook Dialling function;
 - (3) Hand-Free operation through built-in speaker and microphone;
 - (4) Adjustable volume control for speaker and ringer;
 - (5) Display Unit showing Calling and Caller's extension number for Incoming and Outgoing Calls;
 - (6) Display of call duration;
 - (7) System Clock Display;

- (8) Powered via POE Class 2/3;
- (9) Support for H.323/SIP;
- (10) 5" Screen or better for Video;
- (11) Picture-in-Picture Support;
- (12) Integrated Camera with high quality video for video calling;
- (13) Automatic low light correction;
- (14) Video codec support ITU-T H.263/H.263+/H.264 as a minimum;
- (15) Video frame rate CIF 30 FPS or better;
- (16) 2 RJ-45 10/100/1000BT Ethernet Port POE;
- (17) Supporting DHCP Client or Static IP Address Allocation Plan;
- (18) RTCP and RTP Support;
- (19) QoS Support and TOS Diffserv (IEEE 802.1p/q); and
- (20) XML Support.

7.3.5.13 The Administrative Telephone Network shall have the capacity of ringing up to minimum of three telephone sets connected in parallel.

7.3.6 A Voice Mail System (VMS) shall be provided and integrated with the PBX Network to enable administrative telephone users to leave, retrieve and broadcast voice messages. Voice Mail shall only be provided to pre-selected groups of staff or telephones. If feasible Contractor may upgrade Voice Mail System (VMS) provided under Contract Package CP-104 to meet the requirements of this Particular Specification.

7.3.7 Direct Line Telephone Network

7.3.7.1 The Direct Line Telephone Network shall provide instant, non-blocking & uninterruptible communication between key strategic points, which shall include, but not be limited to:

- (1) Train Traffic Control Communication: This is provided for communication with one-touch button selective calling facility between the Traffic Controller in the OCC and Station Controller (SC) at Stations, IR Sectional Control Centres along the DFC Route, Depot Control Rooms, Crew Control Rooms, and other important locations along the route as decided by Engineer, for the control of train movements and effective utilization of section capacity.
- (2) Traction Power Control Communication: This is provided for communication with one-touch button selective calling facility between Traction Power Controller in the OCC, Station Controller at Stations, Switching Posts of Traction Power to the Overhead Alignment and Maintenance Staff Rooms at wayside locations.
- (3) Engineering Control Communication: This is provided for communication with one-touch button selective calling facility between OCC and important Civil Engineering maintenance and work related locations along the track as decided by the Engineer.
- (4) S&T Control Communication: This is provided for direct line communication with one-touch button selective calling facility between OCC and important S&T maintenance and work related locations along the track as decided by the Engineer.
- (5) between Station Control Rooms of New Dadri Station and New Boraki station with one-touch button dialling;
- (6) between Station Control Rooms of New Boraki Station and New Khurja station with one-touch button dialling;
- (7) between Station of DFCC and Interfacing Station Master Room of Indian Railway with one-touch button dialling; and
- (8) between Depot Control Rooms and Station Control Rooms of adjacent stations with one-touch button dialling.

7.3.7.2 The Direct Line Telephone Network shall be built using PBXs at OCC and New Boraki Station. However, PBXs shall have separate extension/line interface cards and separate trunk interface cards to make Direct Line Telephone Network more reliable and non-blocking.

7.3.7.3 Direct Line Network shall facilitate Group Call, Conference Call (with facilities to add additional users (minimum of 6 parties) to an established call) & Emergency Call (with priorities). Direct Line Network shall also facilitate priority level for each category of call.

7.3.7.4 The assignment of the class of service, priority level and features to any Direct Line Telephone extension shall be configurable.

7.3.7.5 Direct Line Console

- (1) Direct Line Consoles provided under Contract Package CP-104 for Chief Controller, Deputy Chief Controller, Assistant Controller, Traffic Controller Traction Power Controller, Signalling Fault Management Controller and Track Controller, having a minimum direct line capacity of 100 lines, shall be upgraded/reconfigured to meet the communication requirement mentioned in this Particular Specification, as these controllers are common for Dadri-Khurja Section of EDFC and EDFC Phase-I.
- (2) Direct Line Consoles shall be provided for Station Controllers in SCR of New Boraki Station and shall have a minimum direct line capacity of 30 lines and shall be capable of interfacing with required direct line extensions.
- (3) Direct Line Console provided at New Khurja Station under Contract Package CP-104 shall be upgraded/reconfigured to meet the communication requirement mentioned in this Particular Specifications.
- (4) The Direct Line Console shall be configured as a desktop model/flush mounted in a desk ergonomically matching with the control room furniture.
- (5) The Direct Line Console shall provide selection facilities in the form of push button and/or soft keys with visual display unit for user to perform, but not be limited to, the following functions as a minimum:
 - (i) originate outgoing calls to the selected user;
 - (ii) select and answer any incoming calls destined for the Direct Line Telephone Console;
 - (iii) originate outgoing calls to a pre-defined group of users;
 - (iv) originate outgoing calls to a group or all users defined by the Direct Line Telephone Console at the time before the call is placed;
 - (v) make conference calls to add additional users to an established call connection;
 - (vi) patch calls or put through two individual users for call connection;
 - (vii) transfer call to PBX extension; and
 - (viii) make and receive emergency call (override facility).
- (6) The Direct Line Console shall be equipped with, but not be limited to, the following facilities:
 - (a) handset;
 - (b) push button or soft key for each Direct Line Telephone;
 - (c) 12-push button keypad for dialling;
 - (d) adjustable volume control for speaker and ringer;
 - (e) hands-free operation through built-in speaker and microphone;
 - (f) powered by the Central communications processor;
 - (g) visual display of details for incoming and outgoing calls;
 - (h) display of call duration;
 - (i) system clock display;
 - (j) lamp for message waiting;
 - (k) lamp for ringing signal; and
 - (l) transmit DTMF signal when call has been connected.
- (7) The Direct Line Communication System shall support a minimum of 8 simultaneous incoming calls to the Direct Line Console to be queued before these calls are answered. The identity of the calling parties in the queue shall be displayed on the Direct Line Console in ascending order of the incoming sequence. Console Controller shall be able to answer calls in queue in any sequence. Call answered shall be removed immediately from the display.
- (8) The selection facilities of the Direct Line Console, in the form of physical push button and/or soft key, shall be labelled with identity of the called party or functions of the selection facilities.

- (9) The selection facilities shall provide selection status indication in the form of LCD or LED displays.
 - (10) Dedicated push button and/or soft keys shall be assigned to each telephone line which can be connected to the Direct Line Telephone/Console.
 - (11) At least 10 spare push buttons and/or soft keys shall be provided for assignment of additional functions or Console/Telephone.
 - (12) The push buttons and/or soft keys of similar functions or nature shall be grouped together to facilitate the user to locate the required selection.
 - (13) The Direct Line Console shall also be provided with functions for operation as an ordinary telephone set. The Direct Line Console shall be equipped with keypad for dialling to originate administrative telephone network call and support on-hook dialling.
 - (14) The Direct Line Console shall give different audio and visual indication for normal and emergency calls.
- 7.3.7.6 Indian Railway Telephone Network shall be integrated with Direct Line Communication System, so that one touch dialling can be done from Direct Line Console to important Operation Locations of Indian Railway as decided by the Engineer.
- 7.3.7.7 Public Switch Telephone Network (PSTN) Lines shall also be integrated with Direct Line Communication System, so that one touch dialling can be done from Direct Line Console to Electric Power Companies, Emergency Services etc. as decided by the Engineer.
- 7.3.7.8 Direct Line Telephones
- (1) Direct Line Telephone shall be provided in the other locations such as IR Sectional Control Centre, Interfacing Station Master Room of IR, Crew Control Rooms, Depot Control Rooms, Switching/Feeding Posts, TPC Maintenance Staff Rooms, Important Civil Engineering Maintenance & Work related Locations and Important S&T Maintenance & Work related Locations etc., to meet communication requirement as mentioned in Clause 7.3.7.1 above.
 - (2) These Direct Line Telephones shall have a minimum direct line capacity of 10 lines and shall be capable of interfacing with required direct line extensions. The Contractor shall however determine the exact size of such Direct Line Telephones during the design phase.
 - (3) Direct Line Telephones provided at SCR of New Khurja Station and any other location as required, provided under Contract Package CP-104 shall be upgraded/reconfigured to meet the communication requirement mentioned in this Particular Specification.
 - (4) It shall be possible from Direct Line Telephone to make normal and emergency direct line calls to the designated controllers in OCC. Different audio and visual indications shall be provided for incoming direct line calls on the Direct Line Consoles or Direct Line Telephone for normal and emergency calls.
- 7.3.7.9 The Contractor shall set up the priority level for Direct Line Consoles/Telephones in consultation with the Engineer.
- 7.3.7.10 Direct Line Console shall have preset buttons such that by pressing one of these buttons shall immediately connect to the destination. On the opposite, when a telephone connected to a Direct Line Communication System is picked up, the corresponding button on the Controller's Console shall immediately flash together with the ringing tone.
- 7.3.8 Integration of Telephone Networks**
- 7.3.8.1 Administrative Telephone Network provided under this Contract shall be integrated with Administrative Telephone Network provided under Contract Packages CP-104 & CP-203 and EPABX Network provided under Contract Packages STP-5, STP-17 and CTP-14 to meet the requirement of this Particular Specification.

7.3.8.2 After integration, Administrative Telephone Networks shall provide following feature transparency across all the PBXs/EPABXs provided under this Contract as well as under Contract Packages CP-104, CP-203, STP-5, STP-17 and CTP-14 :

(1)	Break-In;	(2)	Call Forward;
(3)	Call Park;	(4)	Call Party Name & Number Display;
(5)	Voice Mail	(6)	Call Transfer;
(7)	Call Waiting;	(8)	Conference Call;
(9)	Hot Line;	(10)	Abbreviated Dialling;
(11)	Access Paging;	(12)	Attendant Recall;
(13)	Alternative Route Selection;	(14)	Last Number Redial;
(15)	Line Lockout;	(16)	Malicious Call Trace;
(17)	Recorded Announcement;	(18)	Direct Inward Dialling (DID);
(19)	Direct Outward Dialling	(20)	Distinctive Ringing;
(21)	Last Number Redial	(22)	Music on Hold;
(23)	Speed Dial; and		

7.3.8.3 After integration, functionality as mentioned in Clause 7.3.3 of this Particular Specification shall be available across Administrative Telephones provided under this Contract as well as under Contract Packages CP-104 and CP-203.

7.3.8.4 After integration, it shall be possible to make IP Audio & Video calls across IP Video Phones provided under this Contract as well as under Contract Packages CP-104 and CP-203.

7.3.8.5 Direct Line Telephone Network shall be integrated with Direct Line Telephone Network provided under Contract Packages CP-104 & CP-203 and Dispatch Telephone System provided under Contract Packages STP-5, STP-17 and CTP-14 to meet the requirement of this Particular Specification.

7.3.8.6 After integration, Direct Line Telephone Network shall provide all functionality as mentioned in Clause 7.3.7 of this Particular Specification across all the Direct Line Consoles/Telephones provided under this Contract as well as under Contract Packages CP-104 and CP-203.

7.3.8.7 For above integration requirements at OCC, Contractor shall, either provide new PBX, Telephony Server, Media Gateway, Telephone NMS and other associated equipment at OCC and integrate these equipment with PBX, Telephony Servers, Telephone NMS and associated equipment provided at OCC under Contract Package CP-104; or upgrade the PBX, Telephony Server, Media Gateway, Telephone NMS and other associated equipment provided at OCC under Contract Package CP-104 to meet the requirement of this Particular Specification.

7.3.8.8 If integration at OCC is done by providing new PBX, Telephony Server, Media Gateway and associated equipment at OCC:

- (1) PBX provided under this Contract shall be integrated with PBX provided under Contract Package CP-104, through minimum 2 PRI for Administrative Telephone Network and 2 PRI for DLT Network. PBX provided under Contract Package CP-104 shall be suitably upgraded for this integration.
- (2) Telephony Server provided under this Contract shall be integrated with Telephony Server provided under Contract Package CP-104, through redundant Data Links allowing maximum simultaneous IP Voice Calls and IP Video Calls across Dadri-Khurja section of EDFC, EDFC Phase-I & EDFC Phase-II as per capacity of Telephone Servers & Media Gateways provided under this Contract and under Contract Packages CP-104. Telephony Server & Media Gateway provided under Contract Package CP-104 shall be suitably upgraded for this integration.

7.3.8.9 If integration at OCC is done by upgrading PBX, Telephony Servers, Media Gateway, Telephone NMS and associated equipments provided at OCC under Contract Package CP-104:

- (1) Spare PRI available at PBX provided under CP-104 shall not be utilized for meeting the requirements under this Contract.
 - (2) The Contractor shall be responsible and liable for upgraded PBX, Telephony Server, Media Gateway, Telephone NMS and other associated equipment during Defect Notification Period and during Service Life.
- 7.3.8.10 PBX provided at OCC shall be integrated with EPABX provided at Ahmedabad under Contract Package STP-5 with 4 PRI over E1 Links. PRI Cards/Boards required at OCC shall be provided by CP-105 Contractor while PRI Cards/Boards required at Ahmedabad shall be provided by CTP-14 Contractor.
- 7.3.8.11 PBX provided at New Boraki Station shall be integrated with EPABX provided at New Dadri Station under Contract Package CTP-14 with 2 PRI over E1 Links. PRI Cards/Boards required at New Boraki shall be provided by CP-105 Contractor while PRI Cards/Boards required at New Dadri shall be provided by CTP-14 Contractor.
- 7.3.8.12 PBX provided at New Khurja Station shall be integrated with EPABX provided at New Rewari Station under Contract Package STP-5 with 2 PRI over E1 Links. The PBXs provided at New Khurja under Contract Package CP-104 shall be upgraded/augmented and reconfigured for providing above PRI over E1 Link. Spare PRI available at PBXs provided at New Khurja under Contract Package CP-104 shall not be utilized for meeting this requirement. The EPABX provided at New Rewari shall be upgraded/augmented and reconfigured by CTP-14 Contractor for meeting this requirement.
- 7.3.9 Voice Recording System (VRS)**
- 7.3.9.1 A centralised Voice Recording System (VRS) shall be provided at OCC to record telephone conversations of all controllers in OCC and New Boraki Station. This includes conversation over Direct Line Telephone Network, Control Communication System and Emergency Communication System.
- 7.3.9.2 A centralised Voice Recording System (VRS) is being provided at OCC, to record telephone conversations of all controllers at OCC and Stations of EDFC Phase-1, under Contract Package CP-104. If feasible, Contractor may upgrade/augment/reconfigure this VRS provided under Contract Package CP-104 to meet the requirements of this Particular Specifications.
- 7.3.10 Telephone Network Management System**
- 7.3.10.1 A Network Management System with a workstation, system database, logging printers and mass storage devices shall be provided at the designated place as decided by the Engineer. If feasible, Contractor may upgrade/augment/reconfigure Network Management System provided under Contract Package CP-104 to meet the requirements of this Particular Specifications.
- 7.3.10.2 The Telephone Network Management System shall provide control, supervision and maintenance functions for the Administrative Telephone Network and Direct Line Telephone Network. The following management and administrative functions shall be provided through the use of the centralized maintenance console:
- (1) User Data Management;
 - (2) Fault Monitoring;
 - (3) Performance Management;
 - (4) Call Detail Recording;
 - (5) Voice Detail Recording;
 - (6) Configuration Management;
 - (7) Application Program Interface;
 - (8) Accounting Management;
 - (9) Maintenance History Management;
 - (10) System Diagnostics;
 - (11) Remote Access (RA);
 - (12) Data Logging;
 - (13) Remote Alarm Monitoring; and
 - (14) GUI based Network Topology View.

- 7.3.10.3 Access to the Telephone Network Management System shall be password protected.
- 7.3.10.4 Failure in the Telephone Network Management System shall not affect the normal operation of the TDM based PBX Telephony Network or VOIP based Telephony Network.

7.3.11 **Control Communication System**

- 7.3.11.1 Control Communication System shall be provided to meet omnibus voice communication requirement of Train Traffic Control.
- 7.3.11.2 This is provided for communication with one-touch button selective calling facility between the Traffic Controller in the OCC and Station Controller at New Boraki Station, IR Sectional Control Centres along the DFC Route, Depot Control Rooms, Crew Control Rooms, and other important locations along the route as decided by the Engineer.
- 7.3.11.3 Control Communication System shall be provided using Control Communication Equipment as per RDSO Specification No. RDSO/SPN/TC/66/2007. Control Communication Equipment shall be procured from RDSO approved sources only.
- 7.3.11.4 If feasible, Contractor may upgrade/augment/reconfigure Control Communication System provided under Contract Package CP-104 to meet the requirements of this Particular Specifications.

7.3.12 **Emergency Communication System**

- 7.3.12.1 Emergency Control Communication which is an omnibus communication channel terminating at OCC with the Traction Power Controller shall be provided. This Emergency Control Communication shall not have selective calling facility. Emergency Control Communication shall have Emergency Sockets as per IR Standards for RE Areas at all the Automatic Signals to which this omnibus communication channel is terminated. The Portable Telephone of IR Standard for RE Areas, which will be carried by the crew, can be plugged in case of emergency. This Emergency Control Communication channel can be switched to the other controllers by the Traction Power Controller. For better availability, two emergency control communication channel shall be provided, one terminating on the signal posts of Up track and the second one terminating on the signal posts of Down track.
- 7.3.12.2 Emergency Control Communication up to Automatic Signals shall be extended using Underground Railway Jelly Filled Telecom Quad Cable as per RDSO Specification No. IRS:TC 30-05 with latest amendments.
- 7.3.12.3 Wherever feasible, Telecom Quad Cable provided for Signalling System under Particular Specification-Signalling Works, shall be utilized for Emergency Control Communication. However, in such cases separate Quad shall be utilized for Emergency Control Communication.
- 7.3.12.4 If feasible, Contractor may upgrade/augment Emergency Control Communication provided under Contract Package CP-104 to meet the requirements of this Particular Specifications.

7.4 **Performance Specification**

7.4.1 **General**

- 7.4.1.1 In addition to what has been specified in Chapter 3 the following performance requirements for the telephone system shall be complied.
- 7.4.1.2 Fault tolerant design with protections against failure shall be provided in order to achieve the system availability. Protections shall include, but not be limited to path diversity, redundancy and duplication of reliability critical equipment, component and circuits.

7.4.2 **Reliability**

- 7.4.2.1 The inability to perform any required function, the occurrence of unexpected action or the degradation of performance below the specifications shall be considered as a failure.
- 7.4.2.2 The Contractor shall furnish for the following sub-systems/equipment, the reliability figures, MTBF Hours from the OEMs.
- (1) Switching Module of the PBXs;
 - (2) Processor Module of the PBXs;
 - (3) Memory Module of the PBXs;

- (4) Line and Trunk Interface Module of PBXs;
- (5) Power Supply Module of PBXs;
- (6) Telephony Server;
- (7) Media Gateway;
- (8) Direct Line Consoles;
- (9) Direct Line Telephones;
- (10) Telephone NMS Workstation;
- (11) Control Communication Equipment; and
- (12) Emergency Control Communication Equipment.

7.4.3 **Availability Requirements**

- 7.4.3.1 The Contractor shall implement a RAMS Plan defined in accordance with IEC 62278. Any degraded mode of operation or re-configuration functions provided by the Telephone System shall not be included in the determination of the system availability.
- 7.4.3.2 The availability of the connection within Administrative Telephone Network shall be better than 99.99%.
- 7.4.3.3 The availability of the connection within Direct Line Telephone Network shall be better than 99.999%.
- 7.4.3.4 The Telephone Network Management System shall be considered unavailable if any functions provided by the Telephone Network Management System cannot be properly exercised. The availability of the Telephone Network Management System shall be better than 99.95%.
- 7.4.3.5 The Voice Mail System shall be considered unavailable under any one or combination of the following conditions:
- (i) Message cannot be recorded into the Voice Mail System when the voice mail box of the affected user is not full;
 - (ii) Message cannot be retrieved by the user; and
 - (iii) Corruption of voice message stored in the Voice Mail System.
- 7.4.3.6 The availability of the Voice Mail System shall be better than 99.95%.
- 7.4.3.7 Voice Recording System, if provided in this phase, shall be considered unavailable under any one or combination of the following conditions:
- (1) messages cannot be recorded into the Voice Recording System;
 - (2) messages cannot be retrieved from the Voice Recording System; and
 - (3) corruption of voice message stored in the Voice Recording System.
- 7.4.3.8 The availability of the Voice Recording System shall be better than 99.99%.

7.4.4 **Maintainability Requirements**

- 7.4.4.1 The Contractor shall comply with the maintainability requirements as specified in Clause 3.4.
- 7.4.4.2 The service life of the Telephone System (equipment) shall not be less than 15 years. Service life of all types of cables shall not be less than 25 years. Service life shall be counted from the commencement date of the Defects Notification Period.

7.4.5 **System Safety Requirements**

- 7.4.5.1 The Subsystem shall not present any safety hazard to the operation and maintenance persons.
- 7.4.5.2 All equipment must comply with, and be installed in conformance with IEC 60065, IEC 60364 or equivalent National Electric Code/Uniform Building Code of safety standards.
- 7.4.5.3 All metallic enclosures shall be provided with an earth terminal.

7.5 **Technical Requirement**

7.5.1 PBX Network

7.5.1.1 Administrative Telephone Network and Direct Line Telephone Network shall be based upon PBX Network, which shall conform to applicable ITU-T standards.

7.5.1.2 The PBX Network shall offer a fully integrated and transparent digital service acting as a single digital switch.

7.5.1.3 PBXs to be supplied, installed and commissioned for Administrative Telephone Network at stations shall be equipped to, as a minimum and not limited to, the following:

S.N	Description of Item	New Boraki Station	OCC
1	Equipped Ports	128	64
2	Wired Ports	224	128
3	Analogue Telephone Ports	96	32
4	Digital Telephones Ports	32	32
5	Ports for CO lines	4	8
6	Ports for DID lines	4	8

7.5.1.4 If a new PBX is not provided at OCC and PBX at OCC provided under Contract Package CP-104 is being upgraded/augmented, it shall be upgraded/augmented for a minimum 32 Analogue Telephone Ports and 32 Digital Telephone Ports and meet the requirements for Administrative Telephone Network to be provided under this Contract.

7.5.1.5 The PBXs shall be additionally equipped with Ports for Direct Line Telephone Network over and above the Equipped Ports mentioned in Clause 7.5.1(3 & 4) above.

7.5.1.6 The PBX Network shall provide non-blocking connection for extension calls within the same PBX.

7.5.1.7 For calls through trunks or tie lines, the Administrative Telephone Network shall provide a GOS of 1% for the following traffic intensity during an average busy hour under normal condition without traffic overflow:

- (1) DID trunk traffic intensity at 1.5 HCS per extension;
- (2) CO outgoing trunk traffic intensity at 1.5 HCS per extension;
- (3) Traffic intensity of 18 HCS per digital extension;
- (4) 25% of the station traffic intensity assumed to use tie lines; and
- (5) Traffic intensity of 1.5 HCS per voice-mail system user assumed to use tie lines.

7.5.1.8 For calls through trunks or tie lines, Direct Line Telephone Network shall provide Grade of Service (GOS) of 0.1% during an average busy hour under normal condition without traffic overflow.

7.5.1.9 The extension line interface in the exchange equipment shall match the extension equipment as required and fulfil the following requirements :

- (1) loop resistance of subscriber connected on physical cable pairs shall be limited to 1200Ω. The minimum value of the leakage resistance of the line shall be 20 K Ohms; and
- (2) the exchange line shall block the extension line after certain period of "Off- Hook" condition without a selection being received. This period shall be between 10 and 20 seconds. Busy tone shall be sent to the blocked extension;

7.5.1.10 Redundancy for the important interfaces/modules such as power supply, processor etc. shall be provided.

7.5.1.11 The PBX Network shall be designed such that there is redundancy and diversity in terms of the communication links for call routing and call establishment. This redundancy and

- diversity shall be applicable for call routing and call establishment across Dadri-Khurja section of EDFC, EDFC Phase-1, EDFC Phase-2 and WDFC.
- 7.5.1.12 PBXs shall have separate extension cards and separate digital trunk lines for Direct Line Telephone Network to make it more reliable and non-blocking.
- 7.5.1.13 The system design shall ensure high system availability with minimum common mode failure allowing graceful degradation.
- 7.5.1.14 Network and system shall be resilient to failure providing automatic reconfiguration of equipment with minimum system loss in particular the avoidance of common mode failure of site equipment, fibre, cable and power supply and software affecting system operation.
- 7.5.1.15 Network architecture shall be future proofed to accommodate in the flexible manner enhancements to equipment and systems with respect to hardware and software upgrades.
- 7.5.1.16 PBX Network shall be synchronised to the Master Clock signal for merging into a single synchronised network along with the OFC System. The PBX Network shall have internal clock in free running mode in the event of the failure or absence of the Master Clock signal. The slip allowable in the exchange network shall conform to ITU-T Rec. G.822. A highly resilient telephone network synchronisation scheme shall be developed possibly employing multiple fall back protection and details furnished to the Engineer for review.
- 7.5.1.17 Each PBX shall be powered by 48 V Battery Back-Up System provided by the Contractor. Surge protection shall be provided in each switch.
- 7.5.1.18 The digital extension line equipment shall be capable of data transmission simultaneously with speech (ISDN working).
- 7.5.1.19 All software and configuration data operating the PBX shall be stored in non-volatile memory and shall not be corrupted or lost in case of PBX failure or loss of power supply.
- 7.5.1.20 The Contractor shall be responsible for reconfiguration of routing table of PBXs being provided under Contract Packages CP-104 & CP-203 required to meet the requirement of this Particular Specifications.
- 7.5.2 VOIP based Telephony Network**
- 7.5.2.1 The VOIP based Telephony Network consists of Call Servers, Media Gateways, IT Network, IP Phones, NMS etc.
- 7.5.2.2 The Call Servers and Media Gateways of this VOIP based Telephony Network shall be equipped to support 20 IP Voice Phones and 10 IP Video Phones.
- 7.5.2.3 The Call Server shall have high reliability and there should not be any single point of failure. These Servers shall be provided in (1+1) hot-standby configuration in two different subnets, i.e. if one server fails the second server should provide the complete functionality and be able to take the complete load of the calls automatically without dropping of any existing call.
- 7.5.2.4 The Media Gateways shall be provided in (1+1) hot-standby configuration. The Media Gateways shall be able to restart automatically without human intervention when the external power supply is resumed after power failure.
- 7.5.2.5 The IP Video Phones at New Boraki Station shall connect to Call Servers over Wide Area Network provided under Chapter-6 of this Particular Specification. Additional layer of POE Switches if required shall be provided.
- 7.5.2.6 A Unified Messaging Application shall be provided for VOIP based Telephony Network with facilities such as Email, Voice Mail, Faxes, Conferencing & Collaboration(8 Ports) and Inbuilt Soft Phones. The Unified Messaging Application (UMA) shall be accessible from desktop clients and shall support features such as making/receiving calls, sending/replying/forwarding voice messages and recording live conversation. UMA shall have a unified directory that allows the IP Phones and Soft Phones to call by name and identify their correspondents. The UMA shall be equipped to support 30 users.
- 7.5.2.7 VOIP based Telephony Network shall be synchronized to the Master Clock signal for merging into a single synchronised network.

- 7.5.2.8 VOIP based Telephony Network should provide Logical Partitioning to segregate IP to IP, IP to PBX and IP to PSTN calls as per DOT regulations.
- 7.5.2.9 If integration of VOIP based Telephony Network provided under this Contract and as being provided under Contract Package CP-104 is done by upgrading Telephony Servers, Media Gateways, Unified Messaging Application (UMA) and associated equipments provided at OCC under Contract Package CP-104, these shall be upgraded for 20 IP Voice Phones, 10 IP Video Phones and 30 UMA Users.
- 7.5.3 **Voice Mail System (VMS)**
- 7.5.3.1 The VMS shall enable internal and external telephone users to access specific mailboxes using the following peripherals:
- (1) analogue telephones using DTMF;
 - (2) digital telephones;
 - (3) CO outgoing trunks and DID trunks; and
 - (4) digital trunk.
- 7.5.3.2 Telephone users assigned with VMS shall have a unique voice mailbox which shall be password protected.
- 7.5.3.3 The VMS shall supports 100 users for 24 hours a day. The system shall be expandable to 200 users. The ports connecting to the system shall support traffic intensity offered by 100 users in such a way that 1% GOS shall be achieved. VMS shall provide storage for a total of not less than 240 hours of voice menu and message.
- 7.5.3.4 If Contractor upgrade/augment Voice Mail System (VMS) being provided under Contract Package CP-104 to meet the requirements of this Particular Specification, it should be upgraded for 100 Users.
- 7.5.4 **Voice Recording System (VRS)**
- 7.5.4.1 The VRS shall provide recording of stipulated voice conversations over Telephone System and Mobile Train Radio Communication System. It shall be a digital system providing sufficient capacity for recording up to 4 weeks before being overwritten. The VRS shall comply with the requirements as given below.
- 7.5.4.2 The VRS shall have the facility to transfer the recorded audio to removable archive CD/DVD and USB etc. for long term storage.
- 7.5.4.3 The VRS shall be synchronized with the Master clock System. All the recorded telephone conversation shall be date & time stamped with maximum deviation of 2 seconds.
- 7.5.4.4 The VRS shall be built by an array of identical modules with 1+1 protection.
- 7.5.4.5 The VRS shall provide simultaneous recording in both Main and Standby Modules.
- 7.5.4.6 The VRS shall support simultaneous recording and playback without disrupting the on-line recording.
- 7.5.4.7 The VRS shall provide facilities for user to place a marker on the recording medium to mark any conversation on any channel or any combination of channels at any time.
- 7.5.4.8 The VRS shall provide search function for user to locate any part of the recording medium in terms of:
- (1) date and time;
 - (2) by channel; and
 - (3) search by marker placed by the user.
- 7.5.4.9 The VRS shall provide automatic gain control for voice message recording.
- 7.5.4.10 Following functions, as a minimum, shall be provided through the Workstation connected to the VRS:
- (1) audio monitoring of any channel under recording or playback mode;
 - (2) recording medium movement control including playback, fast forward, fast backward, record, stop and pause; and

(3) recording medium shall indicate the recording time elapsed and the free capacity available for further recording.

7.5.4.11 The VRS shall comply with the following specifications:

1	wow and flutter	:	≤ 0.8% peak
2	frequency response	:	300 to 3400 Hz within ± 3 dB;
3	Signal to noise ratio	:	> 42 dB;
4	Cross talk immunity	:	> 60 dB at 1 KHz;
5	Distortion	:	< 3%
6	Automatic gain control level	:	±3 dB in recording level for all input

7.5.5 Telephone Network Management System

Two Laptops shall be provided for field maintenance. Appropriate software shall be pre-loaded onto the Laptops to access the local maintenance port of the PBX switches for system administration and management.

7.5.6 Block Wiring

7.5.6.1 All the voice circuits from the PBXs shall be terminated at the Main Distribution Frame inside the TER for distribution of the internal and external lines and interface with relevant Subsystems and Project Contractors. The circuit termination shall be of IDC (Insulation Displacement Contact) type.

7.5.6.2 All the data circuits from the PBX shall be terminated at the Digital Distribution Frame inside the TER for distribution of the internal and external lines and interfaces with relevant Subsystems.

7.5.6.3 Multi-core cables shall be provided and connected from the distribution frames inside TER to the distribution frames at the MDF for connection between the PBX and the trunk circuits of PSTN. The interface between the Telephone system and the PSTN circuits shall be at the MDF.

7.5.6.4 Telephone distribution boxes shall be provided and installed at suitable locations for intermediate distribution of the circuits from the PBX switch. The telephone distribution box shall include connection blocks for the circuits termination.

7.5.6.5 Multi-core cables shall be provided and connected from the distribution frames inside TER to the telephone distribution boxes. A minimum spare capacity of 25% shall be reserved in the multi-core cables, distribution frame and the telephone distribution boxes.

7.5.6.6 Standard RJ-11 modular socket shall be provided for termination of the telephones via plug and socket arrangement. The RJ-11 modular socket shall be connected to the nearest telephone distribution boxes to complete the connection between the PBX switch and the telephone.

7.5.6.7 Short circuit and over voltage protection device shall be provided to protect circuits from faults occurring in all outdoor cables.

7.5.7 Outdoor Telephone Cable

Polythene Insulated Jelly Filled (PIJF) Telephone Cable as per RDSO Specification No. IRS: TC 41-97 with latest amendments shall be used for extending external telephone lines out of building housing PBX.

7.5.8 System Expansion

7.5.8.1 The PBXs shall be expandable to the maximum line capacity by adding extra line cards only with the common control equipment, including the processor unit, memory modules, switching modules, power supply unit, remaining unchanged. However the software license for the full line capacity as per the wired requirement given in this PS shall be provided as part of this Contract.

- 7.5.8.2 It shall be possible to provide additional consoles and telephone sets by 25% of installed capacity, in the Direct Line Telephone Network without affecting its performance.
- 7.5.8.3 Wherever the equipment of Telephone System being provided under Contract Packages CP-104 and CP-203 is being upgraded/augmented/reconfigured by Contractor, this upgradation/augmentation/reconfiguration shall not in any way utilize available provision of expansion.

End of Chapter 7

CHAPTER 8 - MOBILE TRAIN RADIO COMMUNICATION SYSTEM

8.1 General

- 8.1.1 The Contractor shall provide Mobile Train Radio Communication (MTRC) System based on GSM-R for wireless voice and data communication to support the operational and maintenance requirements of Dadri-Khurja section of EDFC.
- 8.1.2 The system shall be designed based on European Integrated Railway Radio Enhanced Network (EIRENE)'s Functional Requirements Specification (EIRENE FRS v7.3.0) and System Requirements Specification (EIRENE SRS v15.3.0).

8.2 Scope of Work

- 8.2.1 The Works shall include the survey, design, supply, installation, testing and commissioning of Mobile Train Radio Communication (MTRC) System on Dadri- Khurja section of EDFC.
- 8.2.2 MTRC System is being provided by Indian Railways in Ghaziabad-Mughalsarai section of Indian Railways (IR). As such in sections, where track alignment of Dadri-Khurja Section of EDFC is running parallel to the existing Ghaziabad-Mughalsarai section of IR, Base Station Sub-systems (BSSs) of IR will be shared by DFCCIL. However in sections, where track alignment of Dadri-Khurja Section of EDFC is taking a detour (Including Link Lines) and cannot be served by Base Station Sub-system (BSS) of IR, BSSs of DFCCIL shall be provided by the Contractor.
- 8.2.3 It is envisaged that Network Sub-system (NSS) of MTRC System of Indian Railway used for Ghaziabad-Mughalsarai section shall also be used for MTRC System of Dadri- Khurja section of EDFC. Details of NSS of MTRC System of IR are given in Appendix-II. This NSS shall be upgraded under Contract Packages CP-104 and CP-203, if required, to meet the requirements of EDFC Phase-1 and Phase-2. This NSS of MTRC System of IR shall be further upgraded, if required, by the Contractor to meet the requirements of Dadri- Khurja sections of EDFC.
- 8.2.4 It is envisaged that all operation and maintenance activities of Base Station Sub-system (BSSs) of DFCCIL for Dadri-Khurja section of EDFC shall be managed from Radio Network Management System (Radio NMS) to be provided by Contractor at OCC. Further, it is also envisaged that all operational activities of Network Sub-system (NSS) pertaining to Dadri-Khurja sections of EDFC shall be managed from OCC by upgrading the Client Terminal(s) provided under Contract Package CP-104.
- 8.2.5 Whenever existing equipment of MTRC System of Indian Railway for Ghaziabad-Mughalsarai section are upgraded/augmented/reconfigured to meet the requirement of this Particular Specifications, the available provision for redundancy in existing equipment shall not be compromised.
- 8.2.6 Whenever existing equipment of MTRC System being provided under Contract Packages CP-104 and CP-203 is upgraded/augmented/reconfigured to meet the requirement of this Particular Specifications, the available provision for redundancy in existing equipment shall not be compromised and subsequent to upgradation/augmentation/reconfiguration they shall meet the Technical Requirement and Performance Requirement as stipulated in this Particular Specifications.

8.2.7 Scope of Supplies

- 8.2.7.1 Scope of supply for the MTRC System shall include, but not limited to the following:
- (1) Hardware, firmware, software & licenses required for up-gradation of Network Switching Sub-system (NSS) of Indian Railway to meet the requirement of this Particular Specification;
 - (2) Hardware, firmware, software & licenses required for up-gradation of Client Terminal(s) provided at OCC under Contract Package-104 for all operational activities of Network Sub-system (NSS) pertaining to Dadri-Khurja section of EDFC;
 - (3) Base Station Controller (BSC), Transreceiver Adaptation Unit/Transreceiver Coding Unit (TRAU/TCU) and Radio NMS complete with all hardware, firmware software and licences for Dadri-Khurja section of EDFC. If it is possible to upgrade the BSC,

TRAU/TCU and Radio NMS provided at OCC under Contract Package CP-104 to meet the requirements of this particular specification, Contractor shall upgrade this BSC, TRAU/TCU and Radio NMS duly interfacing with Contractor of Contract package CP-104.

- (4) Base Station Transceivers (BTSs) for Dadri-Khurja section of EDFC. It shall include the supply of towers and antennae to be erected near the BTS.
- (5) Upgradation/Augmentation/Reconfiguration of Radio Dispatcher Consoles and associated hardware/accessories, software and licenses provided under Contract Package CP-104 to meet the requirement of this Particular Specification;
- (6) Cab Radios complete with Power Supply Battery Pack, Antenna and associated hardware/accessories;
- (7) Operational Radios (OPH) & General Purpose Radios(GPH) complete with battery-pack, carry-case and associated accessories;
- (8) Lightning Protection Equipment;
- (9) Distribution Frames;
- (10) Equipment cabinets, racks and cubicles together with mounting brackets and installation material;
- (11) Power supplies, cables, connectors, accessories, cabling and earthing for equipment and tower;
- (12) All software and license required for operation and maintenance of the MTRC System;
- (13) Any other item for fulfilling the requirements of this Contract.

8.2.8 **Scope of Services**

8.2.8.1 The Contractor shall liaise with WPC for issues of import licence and shall also coordinate in conjunction with DFCCIL with all concerned authorities including WPC, SACFA, Civil Aviation authorities and other local authorities and obtain necessary clearances/sanctions for installation and commissioning of the MTRC System. However, all the documents for this purpose shall be signed by DFCCIL. All License fees shall be paid by DFCCIL.

8.3 **Functional Requirement**

8.3.1 **System Services**

To meet operational and maintenance requirements, MTRC System shall support the following services based on the EUROPEAN Telecommunication Standards Institute (ETSI), Global System for Mobile (GSM) Standards and additional requirements specified in EIRENE FRS & SRS documents:

- (1) voice services:
 - a) point-to-point voice calls;
 - b) group voice calls;
 - c) railway emergency voice calls;
 - d) broadcast voice calls;
 - e) multi-party voice calls;
- (2) data services:
 - a) text message bearer service;
 - b) bearer service for automatic fax;
 - c) bearer service for train control application;
- (3) call related services:
 - a) closed user group;
 - b) multi-level priority and pre-emption;
 - c) advanced call handling, such as call hold, call transfer, call queuing, etc;
 - d) barring incoming or outgoing calls;
- (4) railway specific applications:

- a) functional addressing including registration/deregistration by train, engine or functional number;
- b) location dependant addressing;
- c) shunting mode operations;
- d) multiple driver communications within the same train;
- e) railway emergency calls;
- (5) railway specific features:
 - a) set-up of urgent or frequent calls through single keystroke or similar;
 - b) display of functional identity of calling/called party;
 - c) fast and guaranteed call set-up;
 - d) seamless communication support for train speeds up to 120 km/h;
 - e) automatic and manual test modes with fault indications;
 - f) control over mobile network selection; and
 - g) control over system configuration.

8.3.2 Coverage and performance

8.3.2.1 The adequate coverage for a radio installed in a vehicle with an external antenna for at least 95% of the time over 95% of the track along the detours shall be available to meet the system service requirements mentioned above in Clause 8.3.1.

8.3.2.2 The adequate coverage for an operational radio & general purpose radio at 1.5 meter above ground, for at least 95% of the time over 95% of the following designated areas along the detours shall be available in to meet system service requirements mentioned above in Clause 8.3.1.

- (1) all station control rooms, equipment rooms, plant rooms, ancillary buildings and any other areas where the operation and maintenance staff may gain entry;
- (2) all rooms, sheds and open area up to the boundaries of the depot/buildings within each IMSD and Service Buildings;
- (3) administrative offices & residential colonies;
- (4) 200 metres on both sides from centre of track along Detours.

8.3.3 Call set-up time requirement

8.3.3.1 Call set-up time requirements shall be dependent mainly upon priority. The requirements for end-to-end call set-up performance are indicated in the table below:

SN	Call Type	Call Set-Up Time
1	Railway emergency calls	<2s
2	Group calls between drivers in the same area	<5s
3	All operational mobile-to-fixed calls not covered by the above	<5s
4	All operational fixed-to-mobile calls not covered by the above	<7s
5	All operational mobile-to-mobile calls not covered by the above	<10s
6	All low priority calls	<10s

8.3.3.2 The required call set-up times shall be achieved in 95% of cases. Call set-up times for 99% of cases shall not be more than 1.5 times the required call setup time. Set-up times shall include the time required for any translation of functional numbers internal to the EIRENE network.

8.3.3.3 Emergency calls may use fast call setup procedures. All other calls setup time (except group calls) shall be achieved with authentication procedures enabled.

8.3.4 Handover and Cell Selection

- 8.3.4.1 The call hand-over between the RF coverage zones of different base stations shall be, flawless and guaranteed at speeds of 0 to 120 kmph, transparent to the radio users and shall not drop/interrupt on-going calls regardless of their type and mode.
- 8.3.4.2 The call hand-over execution time shall not exceed 300 milliseconds, which is measured as the time taken when the radio detects a signal strength below a pre-defined level to establishing communication using an adjacent base station site providing the new channel.
- 8.3.4.3 The handover success rate shall be at least 99.5% over train routes under design load conditions.
- 8.3.4.4 The above requirements shall also be applicable when call hand-over is between adjacent RF coverage zones of IR and DFCCIL.
- 8.3.4.5 The Contractor shall submit details of the hand-over process as a part of the Detailed Design.
- 8.3.5 Broadcast and Group Call areas**
- 8.3.5.1 Where fixed network users are involved in a group or broadcast call, fixed network users shall be predefined and shall not change during the course of the call.
- 8.3.5.2 The group or broadcast call area used shall have the effect of determining which mobile can participate in the call. It shall be possible to determine the area over which the call takes place by one, or a combination, of the following:
- (1) the location of the call initiator (if mobile originated); and
 - (2) the identity of the group being called (e.g. All users, all trains, etc.).
- 8.3.5.3 Any group or broadcast calls initiated in a given location shall be broadcast over an associated area based on the location of the call originator, and also to any fixed network numbers associated with the originating location.
- 8.3.5.4 The definition of each broadcast or group call area should take into account operational control areas.
- 8.3.5.5 Mobiles configured for reception of railway emergency calls entering into a call area where a railway emergency call is on-going shall automatically join this call.
- 8.3.5.6 Cab Radios configured for reception of a call to all drivers in the same area, entering an area where a call to all drivers in the same area is on-going shall automatically join this call unless involved in a higher priority call or involved in a call of the same priority.
- 8.3.5.7 The Contractor shall be responsible for configuration of broadcast or group call area, over and above configuration already done under Contract Packages CP-104 & CP-203, in consultation with Engineer.
- 8.3.5.8 The Contractor shall be responsible for configuration of mobiles for emergency calls, over and above configuration already done under Contract Packages CP-104, CP-203, in consultation with Engineer.
- 8.3.6 Mobile Equipment**
- 8.3.6.1 Three distinct types of mobile equipment are required. These equipment shall fulfil basic services, facilities and features as specified mandatory in EIRENE FRS v7.3.0 and EIRENE SRS v15.3.0. The Contractor shall provide these mobile radio types:
- (1) Cab Radios – for use by the driver of a train and/or by other on-train systems;
 - (2) Operational Radios (OPH) – for use by railway personnel involved in operations; and
 - (3) General Purpose Radios (GPH) – for general use by railway personnel involved in trackside maintenance;
- 8.3.6.2 It shall be possible to operate all mobiles in the frequency bands around 900 MHz, allocated for use by the Railways.
- 8.3.6.3 Mobile equipment shall function correctly when travelling at speeds from 0 kmph to 120 kmph.
- 8.3.6.4 All Mobile Equipment shall be of following power classes:

Radio Type	Power Class	Power (W)
Cab Radio	2	8
General Purpose Radio (handheld)	4	2
Operational Purpose Radio (handheld)	4	2

8.3.6.5 **Services and Facilities:** Mandatory Requirements as per EIRENE FRS v7.3.0 are mentioned as 'M'. Optional Requirements as per EIRENE FRS v7.3.0 are indicated as Y/N, where 'Y' indicates it is required under this Contract and 'N' indicates it is not required under this Contract. The requirements which are not applicable are shown as N/A as per EIRENE FRS v7.3.0.

(1) The following voice telephony services shall be supported for each type of mobile radio equipment.

	Cab Radio	GPH	OPH
Point-to-point voice calls	M	M	M
Public emergency voice calls	M	M	M
Broadcast voice calls	M	M	M
Group voice calls	M	M	M
Multi-party voice calls	M	Y	Y

(2) The following data applications are to be supported for each type of mobile radio:

	Cab Radio	GPH	OPH
Text message service	M	M	M
General data applications	M	Y	Y
Train control applications	Y	N	Y

(3) The following call related services are to be supported for each type of mobile radio:

	Cab Radio	GPH	OPH
Display of calling user identity	M	M	M
Display of called user identity	M	M	M
Restriction of display of user identity	Y	Y	Y
EIRENE closed user group	M	Y	M
Call forwarding:	Y	Y	Y
Call hold	M	Y	Y
Call waiting	M	M	M
Call barring	M	Y	M
Auto answer service	M	Y	M
Call supervisory information	M	N	Y

(4) The following EIRENE features are to be supported for each type of mobile radio:

	Cab Radio	GPH	OPH
Functional addressing	M	M	M
Location dependent addressing (section 11)	M	Y	Y
Shunting mode	M	N/A	N
Multiple driver communications within the same train (section 5)	M	N/A	N/A
Railway emergency calls	M	Y	M

(5) The Contractor shall furnish, as part of the detailed design, full details of the MMIs and each of the functionalities, for all types of mobile equipment listed above.

8.3.7 Cab Radio

8.3.7.1 The Contractor shall supply 5(Five) Sets of Cab Radio with 6 Hrs Battery Back-up under this Contract.

8.3.7.2 The Cab Radio shall facilitate all mandatory functionality as defined in Clause 5.2 of EIRENE FRS v7.3.0. Besides, functionality of (i) register and deregister on-train users; and (ii) run-time diagnostics; shall also be provided in Cab Radio.

8.3.7.3 The driver man-machine interface of Cab Radio shall comprise of the display, control panel, loudspeaker and handset. The driver man-machine interface shall be suitable for viewing in direct sunlight and in darkness.

8.3.7.4 For post incident analysis, all operation speech and data calls of Cab Radio shall be recorded.

8.3.8 General Purpose Radio(GPH)

8.3.8.1 The Contractor shall supply 50(Fifty) Sets of GPH along with High capacity Battery Pack and Battery Charger under this Contract. Further 50(Fifty) additional Battery Pack for GPH as spares shall be provided under this Contract.

8.3.8.2 The General Purpose Radio shall facilitate all mandatory functionality as defined in Clause 6.2 of EIRENE FRS v7.3.0. Besides, functionality of (i) send/receive emergency calls and (ii) computer interface shall also be provided in General Purpose Radio.

8.3.8.3 The man-machine interface of General Purpose Radio shall comprise of the display, control panel, loudspeaker and microphone. The man-machine interface shall be suitable for use both in day and night.

8.3.8.4 High Capacity Battery and Battery Charger shall be supplied along with each General Purpose Radio

8.3.9 Operational Radio(OPH)

8.3.9.1 The Contractor shall supply 50(Fifty) Sets of Operational Radio (OPH) under this Contract.

8.3.9.2 The Operational Radio shall facilitate all mandatory functionality as defined in Clause 7.2 of EIRENE FRS v7.3.0. Besides, functionality of (i) send/receive emergency calls with facility to enable/disable and (ii) computer interface; shall also be provided in Operational Radio.

8.3.9.3 The man-machine interface of Operational Radio shall comprise of the display, control panel, loudspeaker and microphone. The man-machine interface shall be suitable for use both in day and night.

8.3.9.4 Following accessories shall be supplied along with each Operational Radio

- (1) Hands free car kits;
- (2) High capacity battery;
- (3) Desk top and travel chargers; and
- (4) Antenna adapter.

8.3.9.5 Further 50 (Fifty) additional Battery Pack for Operational Radio (OPH) as spares shall be provided under this Contract

8.3.9.6 For post incident analysis, all operation speech and data calls of Operational Radio shall be recorded.

8.3.10 Radio Dispatcher Console (Controllers Equipment)

8.3.10.1 Radio Dispatcher Console at following positions in OCC shall be upgraded/reconfigured by Contractor to meet the requirements of Dadri-Khurja section of EDFC:

SN	Description	Number
1	Chief Controller	1

2	Deputy Chief Controller	1
3	Assistant Controller	1
4	Traffic Controller	1
5	Track(Civil) Controller	1
6	Signal Fault Management Controller	1
7	Telecom Fault Controller	1
8	Traction Power Controller	1
9	Radio Dispatcher Console at TER	1

8.3.11 **Numbering Plan and cell routing**

- 8.3.11.1 The Contractor shall propose numbering plan compliant with EIRENE FRS v7.3.0 and EIRENE SRS v15.3.0.
- 8.3.11.2 The proposed numbering plan, to the extent possible, shall be consistent with numbering plan of MTRC System of Indian Railway as issued vide RDSO's letter No. STT/WL/MTRC/503 Dated 16.09.2005 (Appendix-I).
- 8.3.11.3 The proposed numbering plan shall be developed over and above the numbering plan developed under Contract Package-104 and CP-203.
- 8.3.11.4 The proposed numbering plan shall address issues pertaining to interoperability requirements of Cab Radio and other Mobile Equipment between DFCCIL and Indian Railway.
- 8.3.11.5 The proposed numbering plan shall be submitted to the Engineer for review before implementation.

8.3.12 **Allocation of Priorities**

- 8.3.12.1 At least five levels of priority shall be defined. The order of priority for different type of calls shall be implemented with the approval of the Engineer. Cab Radios and the Radio Dispatcher Consoles in OCC shall be configured for priorities for various situations.
- 8.3.12.2 To ensure interoperability between DFCCIL and Indian Railway, priorities shall be allocated consistently.

8.3.13 **Call Restriction**

- 8.3.13.1 Various types of call restrictions may be employed by the Employer as an additional security measure. Call restriction facility shall be available and implemented as required by the Engineer. Implementation of such call restrictions shall not affect interoperability between DFCCIL and Indian Railway.

8.3.14 **Group Membership**

- 8.3.14.1 A mobile may be a member of a number of groups. It shall be possible to 'activate' or 'deactivate' the mobile's subscription to these groups.
- 8.3.14.2 Activating a group on the mobile shall allow a user to receive a call from that group. Deactivating a group on the mobile shall prevent the user to receive calls from that group.
- 8.3.14.3 In order to provide interoperability, cab radios shall be members of a number of standard groups:
- (1) Railway Emergency Calls,;
 - (2) All Train Drivers; and
 - (3) Shunting Team.
- 8.3.14.4 All mobiles with railway emergency group call subscription(s) shall be prevented from deactivating the emergency group(s) whilst operational.

8.3.15 Access Matrix

- 8.3.15.1 The Contractor shall develop the Voice Call Requirement Matrix in consultation with the Engineer and submit the same to the Engineer for review and approval. This Voice Call Requirement Matrix shall be developed over and above Voice Call Requirement Matrix developed under Contract Packages CP-104 and CP-203.
- 8.3.15.2 Voice Call Requirement Matrix shall include additional Controllers Equipment and Mobile Equipment as specified by the Engineer during the execution of the Contract.

8.3.16 Telephone Interconnect Call

- 8.3.16.1 Designated Hand Portable Radios shall have the capability of initiating or receiving telephone calls from designated telephones directly without the Controller's intervention.
- 8.3.16.2 Normally all radio users shall be barred from receiving incoming telephone calls or from making outgoing telephone calls. Designated radio users shall only be allowed the facility of telephone interconnect calls. Telephone interconnects calls from/to unauthorised radio/telephone users shall be rejected. The Contractor shall submit full details in this connection.
- 8.3.17 All voice communications of Radio Dispatcher Console, Cab Radio and Operation Radio shall be recorded by the Voice Recording System (VRS) being provided under Contract Package-104. The Contractor shall be responsible for upgradation/reconfiguration, if required, of Voice Recording System (VRS) being provided under Contract Package-104.

8.3.18 Radio Network Management System(Radio NMS)

- 8.3.18.1 The Radio Network Management System shall be a centralised control system with management workstation, system database and mass storage device to be located at OCC.
- 8.3.18.2 The Contractor shall either supply a new Radio Network Management System or the existing Radio NMS provided under Contract CP-104 shall be upgraded for network elements of Dadri –Khurja section of EDFC.
- 8.3.18.3 The Radio Network Management System shall facilitate all management function mentioned below for Network Elements pertaining to Base Station Sub-systems consisting of Base Station Controllers(BSCs), Base Transceiver Stations(BTSs), TRAU/TCU Interfaces etc. of DFCCIL for Dadri-Khurja Section.
- 8.3.18.4 The purpose of Radio NMS is to provide network management capabilities/features that will assist in efficient management of network. The Radio NMS shall be required with wide range of capabilities and scalability. The Contractor shall deliver a Radio NMS that supports all relevant aspects, including, but not limited to Fault Management (FM), Performance Management (PM), Configuration Management (CM) and Security Management for all network elements controlled by it.
- 8.3.18.5 The Radio NMS shall allow users to interact with the system and the network elements controlled by it in a user friendly and efficient way. The Radio NMS applications designed with several hierarchical levels of GUIs, shall have the possibilities to present critical events on all GUI levels.
- 8.3.18.6 The Contractor shall provide detailed descriptions for all NMS interfaces, including but not limited to, those for Configuration Management, Fault Management and Performance Management.
- 8.3.18.7 **Configuration Management**
- The NMS shall be provided with a user view of all administrable data stored in each managed Network Element that accurately reflects the actual data stored in the managed Network Element in real or near-real time.
- (1) The NMS shall provide the possibility to perform configuration management (addition/changes/deletion), directly and by using command files.
 - (2) The NMS shall provide the possibility to manage command files (creation/changes/deletion).

- (3) The NMS shall provide the possibility to add/change/ delete the configuration data for physical equipment and connections simply by choosing the concerned item (e.g. drop down menu).
- (4) In case a user action has an impact on the operational service, a dialog box shall warn the user and give the possibility to cancel the last action.
- (5) The NMS shall not allow adding/changing/deleting a connection without verification (end to end consistency check).

8.3.18.8 **Fault Management**

- (1) The Radio Network Management System shall provide following fault management functionality.
 - (a) The NMS shall collect, display and manage alarms and notification with severity level for all the BSS equipment, interfaces and its own equipment;
 - (b) It shall be possible to define alarms category and severity level and their display shall be customisable;
 - (c) The alarms and notifications shall indicate the network element in which the event occurred, time, data, level, reason (description) and other important data;
 - (d) The alarms shall be automatically cleared from the display when impacted equipment is again in nominal service;
 - (e) User shall have the possibility to easily get information about each displayed alarm and clear or acknowledge a displayed alarm;
 - (f) All the alarms and notification shall be stored during at least 30 days and it shall be possible to search in the alarm history for certain alarms by filtering on any alarm information;
 - (g) Information about the state of the network element shall be displayed with the maximum delay of 10 seconds (in respect of the event origination moment).
- (2) The following alarm conditions shall be provided to the Radio Network Management System as a minimum:
 - (a) loss of communication links;
 - (b) loss of Master Clock synchronisation;
 - (c) failure of power supply unit;
 - (d) changeover to redundant central equipment;
 - (e) base station health status;
 - (f) central equipment health status;
 - (g) low power and no power alarms for all transmitters; and
 - (h) indication of receiver failures.

8.3.18.9 **Performance Management**

- (1) The NMS shall provide data concerning the performance of the individual element of BSS and individual channels with respect to traffic volume so as to optimise the system configuration, equipment deployment, user grouping and future sizing of the system.
- (2) The NMS shall produce statistical reports on the channel usage and system performance. It shall have the facility to monitor base station channel traffic on real time basis. It shall allow flexible adaption of traffic configurations to the dynamic traffic requirements.
- (3) The NMS shall give detailed information about handover (successful / unsuccessful / retry), all type of calls, all type of call drop, traffic and congestion, group calls (successful/failed/calls per GC) etc. These data shall be stored for a minimum of 1 week. The collected data shall be "transparent" i.e. workable without additional calculation.

8.3.18.10 **Security Management:** As part of the NMS solution the functions related to security is of high importance. Such function(s) shall be provided to avoid and protect against unauthorized access and manipulation in conformance to governing security policy. Some of these required functions are given below:

- (1) The NMS equipment shall be protected from access by unauthorized persons and guarantee access to authorized users exclusively according to their respective rights.
 - (2) Authorized users shall have remote access to NMS systems.
 - (3) All the actions shall be logged with the associated user, and these data shall be stored at least 1 week.
 - (4) The access for up to 3 parallel users shall be possible without limitations.
- 8.3.18.11 **Restoration:** The Network Management System shall provide following restoration features
- (1) The NMS shall be equipped with data media capable of storing information to be used for saving the software and settings.
 - (2) In case of the program failure of any NMS component, restoration of data saved in that medium before the failure shall be ensured.
 - (3) The Contractor shall precise the NMS data restoration duration for main server and terminal equipment.
 - (4) The Contractor shall precise the NMS complete system restoration duration for main server and terminal equipment.
- 8.3.18.12 The NMS shall support integrated trace management function for end to end call tracing. It shall be possible to specify the call to be traced by setting the caller number or called number. It shall be possible to save the result of the tracing to the NMS console for future reference. Any performance limitation related to tracing during live traffic shall be described.
- 8.3.18.13 **System Management Printer:** The Network Management System shall be equipped with a common maintenance printer for the production of hard copies of graphical screen information, system parameter data, maintenance fault history, listing of pre-defined system information and various performance management reports. The maintenance printer shall be connected to the radio management system Workstation.
- 8.3.19 **Subscriber Management**
- 8.3.19.1 The day-to-day administration, management and control of MTRC System of DFCCIL for Dadri-Khurja section shall be carried out in real-time from OCC through suitable Client Terminal(s) being provided under Contract Package-104. The Contractor shall upgrade existing Client Terminal(s) provided under Contract Package-104 to meet the requirement of this Particular Specification.
- 8.3.19.2 Some of these functions related to administration, management and control of MTRC System of DFCCIL for Dadri-Khurja section are given below:
- (1) configure(create/change/delete) the numbering plan including functional numbering plan;
 - (2) implement call-barring to prevent uninterrupted access by non-authorized users;
 - (3) define/configure subscription profiles of mobile equipment;
 - (4) allocate priorities to calls;
 - (5) define access class;
 - (6) implement close user group;
 - (7) manage of functional numbering i.e. define, modify or remove relationship between Functional Numbers and MSISDN Numbers;
 - (8) manage the access of mobile equipment to the functional numbering scheme for registration, de-registration and re-registration;
 - (9) implement forced deregistration;
 - (10) define the information exchanged between the mobile and network for registration and deregistration;
 - (11) define, modify or remove relationship between Engine Number and MSISDN;
 - (12) define routing path using short codes for location dependent addressing;
 - (13) configure railway emergency group call area;
 - (14) configuration of Group IDs as per EIRENE FRS v 7.3.0 & SRS v 15.3.0; and
 - (15) retrieve recorded calls using search criteria.

8.3.19.3 Through these Client Terminal(s) it shall be possible to perform configuration management (addition/change/deletion), directly or by using command files. It shall be possible to configure data of physical equipment by choosing the concerned equipment from drop-down menu. It shall also be possible to manage (creation/change/deletion) command files.

8.4 Performance Requirements

8.4.1 General

The following performance requirements for the Radio system shall be complied:

8.4.2 Reliability Requirements

The Contractor shall furnish for the following sub-systems/equipment, the reliability figures, MTBF years from the OEMs:

- (1) MSC sub components;
- (2) Base Station Controller (BSC)/Base station Controller (BSC) Sub components;
- (3) TRAU/TCU or TRAU/TCU subcomponents;
- (4) Base Transceiver Station (BTS);
- (5) Radio Network Management System(Radio NMS);
- (6) Cab Radio ;
- (7) General Purpose Radio (GPH);
- (8) Operational Radio (OPH);
- (9) Any other equipment forming part of the system.

8.4.3 Availability Requirements

8.4.3.1 The Contractor shall implement a RAMS Plan defined in accordance with IEC 62278. Any degraded mode of operation or re-configuration functions provided by the MTRC System shall not be included in the determination of the system availability.

8.4.3.2 The conditions which shall be considered as failures shall include, but not be limited to:

- (1) failure to initiate individual voice call;
- (2) failure to initiate voice group call;
- (3) failure to initiate railway emergency call;
- (4) failure to initiate shunting emergency call;
- (5) failure to initiate voice broadcast call;
- (6) failure of Location Dependant Addressing;
- (7) failure of Functional Addressing;
- (8) failure of any one base station causing gap in RF coverage; and
- (9) failure of Radio Dispatcher Console unable to receive a call.

8.4.3.3 The MTRC system shall have an overall availability of better than 99.99%.

8.4.3.4 The Network Management System shall be considered unavailable if any of the functions provided by the system cannot be properly exercised. The availability of the Network Management System shall be better than 99.95%.

8.4.3.5 Wherever the existing equipment of MTRC System of Indian Railways for Ghaziabad-Mughalsarai Section is being upgraded/augmented/reconfigured, this upgradation/augmentation/reconfiguration shall not in any way compromise the reliability, fault tolerance and capacity of supporting non-stop on line call processing.

8.4.3.6 Wherever the equipment of MTRC System being provided under Contract Packages CP-104 and CP-203 are being upgraded/augmented/reconfigured, this upgradation/augmentation/reconfiguration shall not in any way compromise the reliability, fault tolerance and capacity of supporting non-stop on line call processing

8.4.4 Maintainability Requirements

8.4.4.1 Service life of the MTRC system/equipment shall not be less than 15 years.

8.4.5 System Safety Requirements

8.4.5.1 All equipment shall comply with and be installed in conformance with IEC 60950 and IEC 60364 or equivalent National Electric Code/Uniform Building Code of safety standards.

8.4.5.2 All metallic enclosures shall be provided with an earth terminal and connected to earth.

8.4.6 Interoperability Requirements

8.4.6.1 Base station subsystem (BSS) being provided under this contract shall comply with the inter-operability requirements for mobile equipment (Cab Radio & Hand Portable as per EIRENE) specifications to be supplied under this contract, in use over Indian Railways and to be supplied for other GSM-R networks of DFCCIL.

8.4.6.2 The mobile equipment (Cab Radio & Hand Portable as per EIRENE) specifications to be supplied under this contract shall comply with the inter-operability requirements with BSS in use over Indian and to be supplied for other GSM-R networks of DFCCIL.

8.4.6.2.1 BSS being provided under this Contract shall be inter operable with Network Sub System(NSS) being provided for WDFC under Contract Package STP-5.

8.5 Technical Requirements

8.5.1 General

8.5.1.1 The MTRC System shall be designed based on European Integrated Railway Radio Enhanced Network (EIRENE)'s Functional Requirements Specification (EIRENE FRS v7.3.0 or latest) and System Requirements Specification (EIRENE SRS v15.3.0 or latest). The main components of the system shall be:

(1) Base Station Sub-system (BSS) of Base Station Controller (BSC) controlling Base Transceivers Stations (BTSS) each containing a number of transceivers (TRXs).

In sections, where track alignment of Dadri-Khurja section of EDFC is running parallel to the existing Ghaziabad-Mughalsarai Section of Indian Railway, Base Transceivers Stations (BTSS) of Indian Railway will be shared by DFCCIL. Any up-gradation or strengthening required at BTSS of Indian Railway, for smooth handover between BSSs of Indian Railways and DFCCIL, shall be done by the Contractor.

However in sections, where track alignment of Dadri-Khurja section of EDFC is taking a detour and cannot be served by Base Transceivers Stations (BTSS) of Indian Railway, new Base Transceivers Stations (BTSS) of DFCCIL shall be provided by the Contractor for adequate RF coverage. These BTSS shall be controlled by BSC at OCC. This Base Station Sub-system (BSS) can be provided either by upgrading and using Base Station Controller (BSC) being provided under Contract Package CP-104 at OCC to meet the requirements of this Particular Specifications or by providing a new Base Station Controller (BSC) at OCC.

This BSC shall be linked to the existing Network Sub-system (NSS) of MTRC System of Indian Railway used for Mughalsarai-Ghaziabad Section. Accordingly BSC and associated network elements constituting the Base Station Sub-system (BSS) shall be compatible with this Network Sub-system (NSS) of MTRC System of Indian Railway used for Mughalsarai-Ghaziabad Section. The Base Station Sub-system (BSS) should fulfil all interoperability criteria with existing Network Sub-system (NSS) of MTRC System of Indian Railway and should be supported with IOT documentation. Base Station Sub-system (BSS) to be provided under this Contract shall be capable of supporting data communications for Train Control System i.e. ETCS Level-2.

(2) Network Sub-system(NSS) containing Mobile Services Switching Centre (MSC) with primary responsibility for call control shall be supported by a Visitor Location Register (VLR) containing temporary details of subscribers active within the MSC area, a Group Call Register (GCR) containing attributes of voice group and broadcast call configurations for the related MSC area, Home Location Register (HLR) holding subscribers details on a permanent basis and IN platform based on CAMEL (Customised Application for Mobile Enhanced Logic).

It is envisaged that Network Sub-systems (NSS) of MTRC System of Indian Railway used for Mughalsarai-Ghaziabad Section shall also be used for MTRC System of Dadri – Khurja section of EDFC . As such Network Sub-system (NSS) of MTRC System of Indian Railway shall be suitably augmented / upgraded by the Contractor to meets the requirements of Dadri-Khurja section of EDFC.

(3) Telephone Interface Equipment to facilitate call between GSM-R Users (RDC, Cab Radio, OPH& GPH) and Telephone System (PBX Network) as covered in Chapter-7 of this Particular Specification.

As Network Sub-system (NSS) of MTRC System of Indian Railway used for Ghaziabad-Mughalsarai Section shall also be used for MTRC System of Dadri – Khurja Section of EDFC, Telephone Interface Equipment provided along with this NSS under Contract Package CP-104 shall be suitably augmented / upgraded by the Contractor to meet the requirements of Dadri-Khurja Section of EDFC.

(4) Voice Recording System (VRS) interfaced to above Network Sub-systems (NSS) for recording voice communications taking place on RDC, Cab Radio and OPH. All voice communications of Radio Dispatcher Console, Cab Radio and Operation Radio shall be recorded by the Voice Recording System (VRS) being provided under Contract Package CP-104. The Contractor shall be responsible for upgradation/reconfiguration, if required, of Voice Recording System (VRS) being provided under Contract Package CP-104 to meet the requirement Dadri - Khurja Section of EDFC.

(5) Short Message Service Centre (SMSC) interfaced to above Network Sub-systems (NSS) for exchange of text messages. This SMSC is being provided under Contract Package CP-104. The Contractor shall be responsible for upgradation/reconfiguration, if required, of this SMSC being provided under Contract Package CP-104 to meet the requirement of Dadri–Khurja section of EDFC.

- a) Mobile equipment which includes Cab Radios, Operation Purpose Handset & General Purpose Handset interfacing to the BSSs.
- b) Radio Dispatcher Console provided at OCC.
- c) Subscriber Identity Modules (SIM) containing information specific to single subscriber.
- d) Radio Network Management System (Radio NMS) at OCC for managing the Base Station Subsystem (BSS) of Dadri-Khurja Section of EDFC.

8.5.1.2 Mobile Switching Centre of IR for Ghaziabad-Mughalsarai Section shall be suitably upgraded/augmented for additional capacity of 110 Mobile Equipment (Cab Radio, OPH & GPH). This upgradation/augmentation shall not in any way compromise the reliability, fault tolerance and capacity of supporting non-stop on line call processing. The connectivity (Communication Link), if required, between BSS of Dadri – Khurja section of EDFC and Network Sub-system (NSS) of MTRC System of Indian Railway used for Dadri – Khurja Section shall be provided by Employer.

8.5.1.3 All major equipment and component of the MTRC System being provided under this Contract shall have redundant engineering to minimize the effects of the failure of such equipment to the operations and performance of the MTRC System and in turn meets the Availability Requirements stipulated in Clause of this Particular Specification.

8.5.1.4 Base Station Sub-system (BSS) & Radio Network Management System (Radio NMS) shall be supplied with fault-tolerant architecture to prevent common mode failure so as to ensure continuous operation with minimal loss of facilities in the event of equipment failure.

8.5.1.5 Redundant routing shall be adopted for all fixed telecommunication links and redundant equipment shall be installed within critical components e.g. additional redundant cards.

8.5.1.6 The MTRC System shall support all EIRENE-compliant Mobiles Equipment from different manufacturers.

8.5.1.7 Software shall be designed to accommodate the ultimate, fully expanded capacity, without requiring any change to the hardware or firmware of the installed system and without adversely affecting the overall operation or performance of the MTRC System.

8.5.1.8 The Contractor shall supply the 40 (Forty) GSM-R SIM cards for use with normal GSM mobile sets under this Contract:

8.5.1.9 The Contractor shall submit, as part of the Detailed Design, to the Engineer for review, the full details of all interfaces available at the Cab Radio.

8.5.1.10 OEM's original specifications (data sheets) and other configuration details as a minimum for all equipment listed below shall be submitted with the Preliminary/Detailed Design submissions for review by the Engineer:

- (1) all sub-component of Base station System (BSS) including Base Transceiver Station(BTS), Base Station Controller, TRAU etc.;
- (2) all sub-component required for upgradation/augmentation of Network Sub-system(NSS);
- (3) Radio Network Management System(Radio NMS);
- (4) Cab Radio complete with antenna & MMI;
- (5) Operational Purpose Radio (OPH);
- (6) General Purpose Radio (GPH);
- (7) Antennas of various types;
- (8) Subscriber Identification Module (SIM); and
- (9) All other equipment, including requirements for interfacing with other sub-systems and other project contractors, forming part of the radio system.

8.5.1.11 Base Transceiver Station (BTS), Base Station Controller (BSC) and Trans-coder Rate Adapter Unit (TRAU) shall work from 48 volt DC Battery Backup System. Other equipments (except Cab Radio) shall work from 230 V AC 50 Hz, single phase power supply from the common S&T UPS being provided by the Contractor.

8.5.1.12 All the radios including base stations, hand portable radio and Cab radio shall have a port for field programming and diagnostic access through a Notebook Computer.

8.5.2 Frequency Planning

8.5.2.1 The use of radio frequency (RF) spectrum in India is regulated by the Wireless Planning and Co-ordination (WPC) Wing of the Ministry of Communications, Government of India. MTRC System shall operate within the frequency band of 952.8-954.4/907.8-909.4 MHz. The Employer has been authorised the use of eight frequency pairs in band 952.8-954.4/907.8-909.4 MHz for MTRC System. However, based upon frequency plan separate clearance for the use of specific frequencies shall be obtained from WPC by the Employer. The Contractor shall provide necessary documentary support for this purpose. The Contractor, if so required by the WPC, shall incorporate specific changes in the frequency plan, after mutual discussions.

8.5.2.2 The Contractor shall prepare a comprehensive frequency plan for MTRC System of Dadri - Khurja section of EDFC along with MTRC System being provided by Indian Railways in Ghaziabad-Mughalsarai section of Indian Railway. This comprehensive frequency plan shall address issues like overlap, overreach, interference etc. Any upgradation/replacement/shifting/configuration in BTSs of MTRC System being provided by Indian Railways in Ghaziabad-Mughalsarai section for implementation of comprehensive frequency plan shall be carried by the Contractor.

8.5.2.3 The Contractor shall perform radio frequency planning ensuring efficient use of the available frequency pairs. The frequency plan including detailed calculations shall be submitted to the Engineer for review, as part of the Design.

8.5.2.4 If after conclusion of Radio Planning it is concluded by the Engineer and the Contractor that additional frequency pairs shall be required; Employer will take necessary action to obtain such additional frequency pairs from WPC. The Contractor shall provide necessary documentary support for this purpose.

8.5.2.5 The system design shall have suitable safeguards to ensure that the operation of a radio set from any other system, except MTRC System of Indian Railway, is debarred, and its operation does not affect the operation of MTRC System of DFCCIL in any way.

8.5.2.6 Frequency planning calculations shall ensure that there will be no interference from frequencies within the systems DFCCIL. RF coverage plots to show that there will be no interference from frequencies within the system shall be submitted to the Engineer for review. In case of interference from other systems outside DFCCIL, the Contractor shall inform the Engineer of such violations and will support the Engineer with necessary data/test results to enable the Employer to address and settle the issue with other systems. Remedial action to overcome the interference, if any required, shall be taken by the Contractor.

8.5.3 Radio Frequency Coverage

- 8.5.3.1 In sections, where track alignment of Dadri-Khurja section of EDFC is taking a detour from Dadri-Khurja section of Indian Railway and cannot be served by Base Station System (BSS) of Indian Railway, Base Station System (BSS) of DFCCIL shall be provided by the Contractor.
- 8.5.3.2 Base Station System (BSS) network shall be planned with an appropriate radio network planning tool and an appropriate propagation model for the terrain being covered. Details of the tool and the methodology adopted shall be submitted to Engineer.
- 8.5.3.3 The Contractor shall submit detailed link budget analysis and RF Signal coverage plots both for up-link and the down link for Cab Radio and OPH/GPH (indoor and outdoor coverage) for each base station, to confirm that the required RF coverage stated above can be achieved using the Contractor's proposed antenna system and their locations. Assumptions like dense urban, urban and sub-urban etc. and the specifications of the base station equipment including TX/RX, RF cables, splitters, directional couplers, antenna etc. and the specifications of Mobile Equipment adopted for link budget calculations shall be detailed.
- 8.5.3.4 The coverage level for a radio is defined as minimum field strength of downlink available at 4 metre above ground for at least 95% of the time over 95% of the area. The section of Indian Railways is being provided with minimum coverage level of -95 dbm above Railway Track.
- 8.5.3.5 The coverage level shall be designed to provide satisfactory indoor and outdoor coverage in detour section for an operational radio and general purpose radio for all areas as specified, including indoor areas for which an extra margin shall be considered. Accordingly minimum coverage level of -78 dbm in outdoor terrain shall be available.
- 8.5.3.6 The above mentioned signal strength levels are the worst case downlink signal strength level after taking into account all losses such as propagation loss, feeder losses, fading, climatic losses etc.
- 8.5.3.7 RF coverage and Quality of Service shall be designed for future implementation of ETCS Level 2 for speeds lower than or equal to 120 Km/h.
- 8.5.3.8 Coverage in the two way communication is decided by the weakest transmission direction. It is therefore necessary to balance the up and down paths.
- 8.5.3.9 Diversity reception shall be provided for protection against failure in receive antennas or receiver multi-couplers and to provide gain in the Up-Link path.
- 8.5.3.10 The Contractor shall submit the particulars of locations of radio base station sites, requirements of antenna and aerial support structure (radio towers) necessary to provide the specified area coverage indicating full indoor and outdoor coverage as specified above. The MTRC System shall have tower mounted antennae for wide area coverage.
- 8.5.3.11 RF signal strength/coverage shall be measured for outdoor as well as indoor areas for down link and results submitted to the Engineer for review as part of System Acceptance Test. To improve the indoor coverage additional measures shall be taken by the Contractor if so required.

8.5.4 System Radio Channel Requirements

- 8.5.4.1 The MTRC System shall not provide traffic blocking exceeding 1%. Traffic calculations considering all radio communication needs of fixed and mobile radio subscribers to establish these requirements shall be submitted as part of detailed design. Requirements of radio communications during emergencies and crisis management should also be considered.

The MTRC System shall support the following modes of traffic as a minimum:

- (1) Normal traffic, this shall be the communication between radios under the RF coverage zone of the same base station.
- (2) Inter-base station traffic, this shall be the communication between radios under the RF coverage zones of different base stations.
- (3) Emergency traffic shall be the communications during emergency operations.

8.5.4.2 The MTRC system shall as a minimum be equipped with 6 traffic channels, both for voice & data on IR and EDFC routes.

8.5.5 **Communication between BTSs and BSC**

8.5.5.1 Base Transceiver Stations (BTSs) shall be linked to the BSC through a logical ring network structure, so that link failure on one side shall not affect the availability of the mobile network in any way. All interconnections forming the ring, being BTS-BTS or BTS-BSC shall be realised in a separate geographical/physical route.

8.5.5.2 The logical BTS-ring structure shall provide protection switching for all channels/bandwidth between BTS and BSC. BTS shall have dual ports for connection in the ring configuration. A maximum of 4 BTSs shall be allowed in one logical ring.

8.5.6 **Cab Radio**

8.5.6.1 Cab Radios shall meet all mandatory system requirements as defined in EIRENE SRS v15.3.0. Besides, it shall also meet all system requirements required to comply with this Particular Specification.

8.5.6.2 Cab Radios shall meet all Environmental and Physical requirements as mentioned in Clause 5.7 of EIRENE SRS v15.3.0.

8.5.6.3 Rolling Stock to be equipped with Cab Radio shall have 110 V DC Power Supply, which will be used for powering up Cab Radios. Power Supply Unit required for conversion of 110 V DC to any other voltage required shall be provided by the Contractor. All wiring/cabling from 110 V DC Power Source to Cab Radio shall be done by the Contractor. Required protection circuits such as Over voltage protection or Short-circuit protection shall be provided by the Contractor.

8.5.6.4 **Cab Radio Man-Machine Interface**

(1) Cab Radio Man Machine Interface shall comprise of the following components:

- display;
- control panel;
- loudspeaker;
- handset with push –To-Talk button.

(2) Cab Radio equipment installed in a driver's cab shall not obstruct the driver's vision or otherwise hinder the safe driving of the train.

(3) Layout of the equipment in the cab shall be decided in consultation with the Engineer.

(4) The Cab Radio shall be provided with sufficient filtering and suppression circuit to make it immune to radio interference.

(5) Two identical input powers from rolling stock power supply in main and hot standby mode of operation shall feed the cab radio unit. The switchover from the main to hot-standby power supply shall be transparent and not cause any loss in communication to the radio users. The Contractor shall use converters, if required, to power the Cab Radio.

(6) All call related functions except talking shall be possible with the handset on or off the hook.

(7) The driver shall be able to adjust the brightness of buttons, indicator lights and display according to the ambient lighting in the cab.

(8) The driver shall be able to adjust the contrast of the display.

(9) The emergency call button shall be red and shall be protected against accidental use.

(10) Any displays shall be clearly readable from a normal driver's position, assuming a normal reading distance.

(11) Display characters shall have a minimum height of 5 mm.

(12) MMI shall be splash proof and suitable for viewing in direct sun light and in darkness.

(13) Cab radio shall prevent tampering.

(14) If contact with the mobile radio network is lost, the cab radio shall give an audio and visual indication.

(15) Driver Man-Machine interface shall be installed in the leading cab and also the trailing cab(if available) of each rolling stock.

- (16) Facilities shall be provided to support a list of stored names /numbers of up to a minimum of 100 entries.
- (17) Abbreviated dialling facility shall be supported.

8.5.6.5 Built-in Test Routine

- (1) Built-in test routines shall be able to test the cab radio and the radio MMI. These routines shall operate in an off-line mode to allow a complete functional test of the module in problem.
- (2) The Contractor shall ensure that upon every initialization cab radio shall perform automatic self-diagnostic routine test on the all Train borne radio Communication Equipment. An audible tone shall indicate the readiness state of the Train Radio Communication System and associated equipment.
- (3) The fault and self-diagnostics information shall be processed and sent to the dispatcher's console (specific RDW to be decided during design) to indicate the status of the cab radio to facilitate prompt fault diagnosis and enable DFCCIL staff to locate faulty modules for first line replacement.
- (4) The cab radio shall be provided with a radio test port to enable full specification testing. The port shall be able to interface to a Notebook Computer. The selection of functions and data to be monitored shall be menu driven by the Notebook Computer. The data indicating the cab radio's performance shall be displayed in an informative and comprehensive manner. Information shall be presented graphically where possible. The Contractor shall provide a full description of cab Radio performance functions to be monitored, as well as those which are not monitored.

8.5.6.6 Run Time Diagnostics

- (1) The cab radio shall be capable of performing a suite of runtime diagnostic tests on all physical interfaces.
- (2) Failure of an interface shall be reported to the driver via the display on the MMI indicators.
- (3) All failures shall be recorded in the activity log at OCC.
- (4) Diagnostic tests shall not interfere with normal operation of the cab radio.

8.5.6.7 Cab Radio Antenna

- (1) The antenna shall be mounted suitably on the roof of the rolling stock to meet the required performance specifications without causing any electromagnetic interference to other equipment on board the Train.
- (2) The Contractor shall submit the drawings showing the placement of the antenna on the roof of the rolling stock. The low profile antenna on the roof of the rolling stock shall not infringe the schedule of dimensions.
- (3) The antenna and mounting brackets shall be extremely rugged low profile design and shall withstand the effects of washing plants, mechanical vibration, dust accumulation and other physical hazards typical of railway environments.
- (4) Where applicable, the antenna feed shall consist of pre-terminated, double screened, flexible, 50 Ohm, RF feeder cable. The feeder routing shall be designed to avoid effects of EMI.
- (5) The orientation and placement of the antenna on the roof of the rolling stock shall ensure minimum VSWR and maximum coupling of RF signal.
- (6) Cab radio antenna shall as a minimum comply with requirements of Shock and vibrations etc. The Contractor shall submit to the Engineer for review complete specifications/OEM's datasheets of cab radio antennas considered in the RF coverage design.
- (7) Cab radio antenna shall be separated from other antennas to ensure no desensitization.

8.5.7 Operational Purpose Radio

- 8.5.7.1 Operational Radios shall meet all mandatory system requirements as defined in EIRENE SRS v15.3.0. Besides, it shall also meet all system requirements required to comply with this Particular Specification.

8.5.7.2 Operational Radios shall meet all Environmental and Physical requirements as mentioned in Clause 7.5 of EIRENE SRS v15.3.0.

8.5.8 **General Purpose Radio**

8.5.8.1 General Purpose Radios shall meet all mandatory system requirements as defined in EIRENE SRS v15.3.0. Besides, it shall also meet all system requirements required to comply with this Particular Specification.

8.5.8.2 General Purpose Radios shall meet all Environmental and Physical requirements as mentioned in Clause 6.4 of EIRENE SRS v15.3.0.

8.5.9 **Antenna Towers at Radio Base Stations**

8.5.9.1 The towers shall be designed and constructed for working and installation in the geographical and environmental conditions.

8.5.9.2 All towers shall comply with the requirements of Standard EIA/TIA-222-E and Indian Standard IS-800, 808, 226/2062, 1367, 1161, 2629, 5358. In case of any conflict between the two standards, the Indian Standards shall prevail. Contractor shall always immediately seek advice from the Engineer in the event of conflict.

8.5.9.3 The towers shall be self-supporting steel structure. The maximum height of the tower shall normally not exceed 40 meter. However in exceptional circumstances, higher height may be permitted by the Engineer.

8.5.9.4 All steel used shall be hot dip galvanised in full compliance with the relevant ISO or ASTM specifications or IS 4759. The galvanised tower members shall further be treated suitably to protect from rusting.

8.5.9.5 Any damage to the galvanising during the erection shall be made good by the Contractor before acceptance by the Engineer.

8.5.9.6 The towers shall be designed to withstand a minimum wind load of 200 kmph or the maximum wind speed of the concerned zone as currently defined by the Indian Meteorological Department (whichever is higher) while supporting the maximum number of antennae plus two additional antennae required of the same type/size, located at full height.

8.5.9.7 For design purposes, the combined projected area of these antennae shall be maximised against the wind direction.

8.5.9.8 The tower loading as a minimum must take into account the wind load, seismic conditions, load of antenna, antenna support structures, live load of installation and maintenance staff, all tower accessories and at least 100% safety margin against structural failure for the actual anticipated configuration.

8.5.9.9 The Contractor shall design/build/erect the base/ foundations/ earthing/ fencing of the tower. It is expected that the foundations can be constructed from standard concrete and reinforcing steel. However, the Contractor shall ensure the adequacy of the soil bearing pressure to support the weight of the tower including all accessories, antennae support structures and live load of installation and maintenance staff and to resist the overturning moments generated in the survival wind speed. During construction of the Tower foundation, the Contractor shall be responsible for the safety of the site and the structures nearby. The earthing design shall be as per IS 3043 or better standard for Radio Towers and the foundation and earthing design shall be got approved from the Engineer before implementation.

8.5.9.10 A rest platform with guard railing and seat every 20 m. and a 400mm wide climbing ladder with 20 mm diameter rungs at intervals of 300 mm to the top of the tower shall be provided. Design of ladder, the platforms and the tower shall also consider the live load of a number of installation/maintenance personals at different levels. Working platforms at the levels where antennas are installed shall be such that these will facilitate installation and maintenance personal to work on the antennas without any additional supports and without any undue risk.

8.5.9.11 The ladder shall be securely and rigidly fixed so that the tower faces form a safety cage. Backward tilt shall not be acceptable.

- 8.5.9.12 The linear and torsional sway of the tower under the worst loading conditions shall be restricted to a value such that no degradation of system performance is experienced.
- 8.5.9.13 All tower connection nuts and bolts shall be made of steel conforming to the requirements of IS 6639, IS 13634 or ASTM A-325 or an equivalent international standard, and shall be hot dip galvanized. Lock nuts shall be provided and installed for all bolts without exception.
- 8.5.9.14 All towers shall be equipped with a suitable cable rack to house the feeder cable to antenna, and cable clamps of suitable design shall be provided and installed.
- 8.5.9.15 The towers shall be equipped with Aviation Warning Lights in conformity with the relevant requirements of ICAO.
- 8.5.9.16 Pockets and depressions likely to hold water shall be avoided, and where unavoidable, shall have suitable draining facility.
- 8.5.9.17 For earthing of the tower, holes of suitable diameter shall be made near the base of the tower. At least two earths at adequate distance apart interconnected shall be provided. The earth resistance shall be less than one ohm under all weather conditions.
- 8.5.9.18 The tower shall have lightning conductors of appropriate design and size, which shall be earthed through dedicated copper conductors of suitable cross section coming down from the top of the tower to the base of the tower to be grounded.
- 8.5.9.19 The Contractor shall submit the tower structural design, the foundation design and other details to the Engineer for review and consent.
- 8.5.9.20 Life of the tower shall be at least 40 years.
- 8.5.9.21 A means of preventing unauthorised access onto the ladder shall be provided.

8.5.10 **Base Station Outdoor Antenna**

The outdoor antenna shall be of robust construction utilising corrosion resistant aluminium alloy and shall be protected from lightning. The feeder cable connection shall be weather-proof and fully sealed. The Contractor shall submit complete specifications/OEM's datasheets of various types of base station antennas considered in the RF coverage design.

8.6 **System Expansion**

- 8.6.1 The MTRC System design shall cater for modular expansion at all hardware locations to accommodate future requirements and/or upgrades without the need for replacement of the installed hardware and software during the equipment lifetime. Expansion/up-gradation of the MTRC System shall be possible by addition of modules, cards/sub-racks and additional licenses for additional base stations. The contractor shall submit to the Engineer the expansion capability of various equipment and sub-systems for review.
- 8.6.2 The equipment installed in the TER at OCC shall meet the requirements of expansion to provide additional capacity of 25%.
- 8.6.3 Wherever the existing equipment of MTRC System of Indian Railways for Gaziabad-Mugalsarai Section is being upgraded/augmented/reconfigured, this upgradation/augmentation/reconfiguration shall not in any way utilize available provision of expansion.
- 8.6.4 Wherever the equipment of MTRC System being provided under Contract Package CP-104 and CP- 203 is being upgraded / augmented / reconfigured, this upgradation / augmentation / reconfiguration shall not in any way utilize available provision of expansion.

*** End of Chapter 8 ***

CHAPTER 9 - MASTER CLOCK SYSTEM

9.1 General

- 9.1.1 The Master Clock System shall provide 'Synchronized Time Information' using Global Positioning System (GPS) as time source.
- 9.1.2 This Synchronized Time Information shall be used to synchronize slave clocks which shall be located at Station and IMSD in Dadri-Khurja section of EDFC.
- 9.1.3 This Synchronized Time Information shall also be provided to other Interfacing Systems/Sub-systems and shall be achieved by means of the Network Time Protocol (NTP).
- 9.1.4 Whenever existing equipment of Master Clock System being provided under Contract Packages CP-104 is upgraded/augmented/reconfigured to meet the requirement of this Particular Specifications, the available provision for redundancy in existing equipment shall not be compromised and subsequent to upgradation/augmentation/reconfiguration they shall meet the Technical Requirement and Performance Requirement as stipulated in this Particular Specifications.

9.2 Scope of Supply for Clock System

The scope of supply shall include, but not be limited to, the following:

- (1) Central Master Clock System;
- (2) GPS Receiver and Antenna;
- (3) Sub-Master Clocks;
- (4) Slave Clocks (Analogue and Digital Clock Display Units);
- (5) Clock Management System;
- (6) Data & Power Supply Cables including Terminations;
- (7) Earthing and Lightning Protection Devices;
- (8) Installation, Testing and Commissioning Materials; and
- (9) Any other item required to complete the scope of the works.

9.3 System Requirements

- 9.3.1 The Master Clock System shall be based on a 'Central Master Clock', which shall be synchronised to 'Universal Time Co-ordinated' (UTC) by Radio Signals transmitted via the US Department of Defence's 'Global Positioning System' (GPS) Real Time Navigation Satellites.
- 9.3.2 A GPS Receiver at OCC shall receive the Time Source through a Rooftop Antenna from the satellites of the GPS.
- 9.3.3 The Time Source shall be sent to a Central Master Clock Unit which shall convert the Time Source to synchronization pulses for the use of the slave clock units. The Central Master Clock Unit shall also distribute the time information to Sub-Master Clocks using NTP by an Ethernet Interface.
- 9.3.4 At New Boraki Station and IMSD, Sub-Master Clock Units shall receive the time information from the Central Master Clock and shall convert it into synchronization pulses for the slave clock units at those locations.
- 9.3.5 If feasible, Central Master Clock provided under CP-104 may be upgraded/augmented/reconfigured by Contractor to meet the requirements of this Particular Specification.
- 9.3.6 Slave Clocks shall be connected to the Sub-Master Clock Units. Slave Clocks Schedule is as below:

SN	Station/Depot	SM Room/Depot Control Room		Building
		Digital	Analogue	Digital
1	New Boraki	1	1	6

2	IMSD	0	0	4
---	------	---	---	---

9.3.7 The Slave Clocks shall be of analogue or digital types. The clock face design shall ensure that these clock units shall provide good visibility.

9.3.8 Each of the Systems/Sub-system that require Synchronized Time Information shall be connected to the OCC or Station LANs and shall obtain the information using NTP from Master Clock System.

9.4 Performance Specifications

9.4.1 General

9.4.1.1 In addition to what has been specified in Chapter-3, the following performance requirements for the Master Clock System shall be complied.

9.4.1.2 Fault tolerant design with protections against failure shall be provided in order to achieve the system availability. Protections shall include, but not be limited to path diversity, redundancy and duplication of reliability critical equipment, component and circuits.

9.4.2 Reliability

9.4.2.1 The inability to perform any required function, the occurrence of unexpected action or the degradation of performance below the specifications shall be considered as a failure.

9.4.2.2 The Contractor shall furnish to the Engineer the reliability figures i.e. MTBF Hours from the OEMs of the following sub-systems/equipment:

- (1) Master Clock;
- (2) Sub-Master Clock; and
- (3) GPS Receiver.

9.4.3 Availability Requirements

9.4.3.1 The Contractor shall implement a RAMS Plan defined in accordance with IEC 62278. The Contractor shall submit to the Engineer for review the RAMS analysis for the Master Clock System to establish the requirements of availability specified herein below.

9.4.3.2 The Master Clock System shall be considered unavailable if the clock signal is not available at any location or the accuracy of the clock signal is below the specification. The availability of the Master Clock equipment shall be better than 99.99%.

9.4.4 Maintainability Requirements

9.4.4.1 The Contractor shall comply with the maintainability requirements as specified in Clause 3.4.

9.4.4.2 The service life of the Master Clock System shall not be less than 15 years.

9.4.5 System Safety Requirements

9.4.5.1 All equipment must comply with, and be installed in conformance with IEC 60065 and IEC 60364 or equivalent National Electric Code/Uniform Building Code of safety standards.

9.4.5.2 All metallic enclosures shall be provided with an earth terminal which shall be connected to Earth.

9.5 Technical Requirements

9.5.1 Central Master Clock

9.5.1.1 The Central Master Clock shall consist of Redundant GPS Receivers which shall continuously collect the external time information, e.g. Universal Coordinated Time (UTC) and derive Indian Standard Time by offsetting as required.

9.5.1.2 Antenna of GPS Receiver shall be weather proof. It shall be tolerant to direct sunlight, wind, rain and other sources of water. The Antenna shall be mounted at appropriate location to be identified during design. Surge Protector shall be provided between Antenna and Central Master Clock Units.

- 9.5.1.3 The GPS receiver shall not suffer from the GPS week counter rollover problems, which cause the week counter to reset to zero every 1024 weeks.
- 9.5.1.4 To protect the Master Clock equipment from lightning, surge protectors shall be provided to connect from the GPS antenna to the ground to safely shunt potentially damaging voltage on the antenna to the ground.
- 9.5.1.5 The Central Master Clock shall consist of Redundant Master Clock Units. The Master Clock Units shall detect the absence or corruption of the UTC time standard signal and give an alarm if either of these occurs. Bad data resulting from a satellite malfunction, temporary reception problems or an erroneous upload to satellite is not used. Errant timing that causes errors in the timing system shall be avoided.
- 9.5.1.6 The Master Clock Units shall have their own oscillator and be able to maintain accurate time with an accuracy of 30 milliseconds w.r.t. GPS Reference for duration of 24 Hours of loss of time synchronization with GPS.
- 9.5.1.7 The Master Clock Units shall be self-correcting in the event the synchronization from the GPS is lost and re-established.
- 9.5.1.8 The Central Master Clock Units shall support connectivity of Ethernet TCP/IP Network, RS485 and RS232 as required.
- 9.5.1.9 The Master Clock Units shall include Network Time Server to provide NTP timing for other interfacing Systems/Subsystems connected to the OCC/Stations/Depot/Office LANs. The type and quantities of the interfaces shall be determined by the interface requirements of the Subsystems under this Contract and relevant Interfacing Project Contractors. Network Time Synchronization over the Data Network using NTP shall be with an accuracy of ± 0.01 seconds per 24 hours.
- 9.5.1.10 Audio and Visual Alarm outputs shall be provided to indicate loss of Time Synchronization or Power.
- 9.5.2 Sub Master Clock**
- 9.5.2.1 The Sub-Master Clock at Station shall be synchronized by the Central Master Clock over NTP. It shall be possible for Sub-Master Clock to work both as NTP Server and NTP Client.
- 9.5.2.2 The Sub-Master Clock shall be able to detect the absence or abnormality of the synchronized time signal from the Central Master Clock. The Sub-Master Clocks shall have its own internal clock and be able to maintain time with a minimum accuracy of 1s a day when they do not receive signals from the Central Master Clock. On restoration of the Master Clock Signal, the Sub-Master Clock shall validate the signal and after successful validation the Sub-Master Clock shall self-correct if necessary.
- 9.5.2.3 Local Display of the time shall be provided. Display shall include hours and minutes.
- 9.5.3 Display Clocks**
- 9.5.3.1 All display clocks shall be synchronized by the Central Master Clock Unit/Sub-Master Clocks. The slave clock shall be able to free run from local quartz oscillators with drift of one second per day in the absence of communication link or synchronisation sources.
- 9.5.3.2 Analogue Slave Clocks for indoor use shall be single sided with minimum dial diameter of 30 cm, with minimum viewing distance of 30 metre.
- 9.5.3.3 Digital Slave Clocks for indoor use shall be 7 Segments LED type with minimum digit height of 57 mm, with minimum viewing distance of 20 meter.
- 9.5.3.4 The displayed time of all display clocks shall be hours and minutes.
- 9.5.3.5 The display shall be clear under relevant, frequently occurring lighting conditions, including direct sunlight (from behind and in front) and when there are any reflections in the clock faces.

- 9.5.3.6 The optical characteristics of the transparent display cover shall be selected such that the light transmission and display contrast are suitable for the environment in which the clocks are installed.
- 9.5.3.7 Subject to the architectural constraints for each specific location, the clocks shall either be wall mounted or ceiling mounted or pole mounted. The Contractor shall determine the mounting method and submit to the Engineer for review before installation.
- 9.5.3.8 The Slave Clocks shall be manufactured to be used in non-air-conditioned environment with high humidity exposure.
- 9.5.4 The Master Clock System shall be capable of working from 230 Volts +/- 10% AC 50 Hz Power Supply.
- 9.5.5 **Clock Management System**
- 9.5.5.1 The status of the Master Clock Systems including GPS Receiving System, Master Clock Units, Clock Distribution System, NTP Servers, Sub-Master Clocks and Slave Clocks shall be monitored using SNMP by proposed dedicated Clock Management System to be provided at OCC.
- 9.5.5.2 The Clock Management System shall provide full configuration support for Master Clock Units and Sub-Master Clocks.
- 9.6 System Expansion**
- 9.6.1 The Master Clock System shall be equipped with capacity to provide clock signal and timing reference distribution to 5 additional locations for other System/Subsystem or Sub Master Clocks.
- 9.6.2 The system shall be able to support the required number of display clocks plus at least 10 additional Slave Clocks at each location.
- 9.6.3 Wherever the equipment of Master Clock System being provided under Contract Package CP-104 is being upgraded/augmented/reconfigured, this upgradation/augmentation/reconfiguration shall not in any way utilize available provision of expansion.

*** End of Chapter 9 ***

CHAPTER 10 - VHF COMMUNICATION SYSTEM

10.1 25 Watt VHF Transceivers

10.1.1 General

10.1.1.1 VHF Communication System shall be created at Stations using 25 Watt VHF Transceivers. VHF Transceivers along with Power Supply and Associated Accessories & Cables shall be supplied by the Contractor.

10.1.1.2 25 Watt VHF Transceivers shall be installed in Station Control Room and any other specified place as decided by the Engineer. Omni-Directional Antenna for 25 Watt VHF Transceivers shall be mounted on a suitable Pole/Mast at a height of 15 meters from the ground level. Omni-Directional Antenna and Pole/Mast shall be supplied by the Contractor.

10.1.1.3 Provision of Voice Recording of conversation taking place on 25 Watt VHF Transceivers shall be provided through Voice Recording Equipment. This recording shall be Date and Time Stamped along with Stamping of Station Identity and VHF Channel Identity. Storage of Voice Communication shall follow FIFO (First-In-First-Out) methodology. There shall not be any compression of the Voice Signals. The capacity of Voice Storage shall be at least 4 -weeks. There shall be an Ethernet Interface Port through which Recorded Voice can be transferred to Laptop for replay or taking backup on CD/DVD. It shall be possible to replay the Voice Recordings by simple operation of some feature/function key.

10.1.1.4 48 V DC Battery Backup System under Chapter-11 shall be used as a Power Source for these 25 Watt VHF sets.

10.1.1.5 Specification of 25 Watt VHF Transceivers shall be as given below:

General		
1.	Frequency Range	136-174 MHz
2.	No. of Channels	16 Channels or more
3.	Channel Spacing	12.5 KHz
4.	Frequency spread	5 MHz or more without degradation in Tx/Rx specifications.
5.	Frequency Stability	5 PPM or better
6.	Type of Operation	Simplex, press to talk with built in condenser microphone and the speaker.
7.	Type of Antenna	Omni directional antenna complete with cable and other accessories.
8.	Speaker	Internal Speaker as well as Socket for External Speaker shall be provided (The Internal Speaker shall be cut-off when External Speaker is used).
9.	Output Impedance	50 Ω
10	Protection	Reverse Polarity protection shall be provided. The final transistor shall be protected against high VSWR
Transmitter		
1.	RF Power output	25W +/- 0.5 dB
2.	Frequency Deviation	+/- 2.5 KHz

3.	Modulation Distortion	Better than 5%
4.	Modulation Fidelity	Within +1, -3 dB of 6 dB/Octave
5.	Spurious & Harmonics Supersession	Better than 60 dB
Receiver		
1.	Sensitivity	0.30µV/-118 dBm at 12 dB SINAD
2.	Squelch Sensitivity	Better than -119 dBm
3.	Selectivity	Better than 60 dB
4.	Image and Spurious Rejection	Better than 65 dB
5.	Audio Output	1W with less than 5% distortion at 1 KHz reference measured at specified audio frequency output.
6.	Audio Frequency Response	Within +1, -3dB of 6dB/Octave
Feature-wise Configurations		
1.	Simple press to talk	
2.	Protection against high VSWR	
3.	Channel spacing (12.5KHz)	
4.	PTT ID Encode	
5.	CTCSS/DCS Signalling	
6.	Busy Channel Lockout	
7.	Channel scanning with call quieting facility	
8.	DTMF Signalling with Selective Calling	
9.	Selective Call Decode.	
10.	Capable of being killed/Unkilled.	

10.2 5 Watt VHF Walkie-Talkie Sets

- 10.2.1 The Contractor shall supply 100 Nos. 5 Watt VHF Walkie-Talkie Sets complete with their standard OEM Battery Packs, Carrying Case and Charger.
- 10.2.2 The Contractor shall also supply 10 Nos. Multi-Unit Charger (for charging minimum 5 units) for charging of 5 Watt VHF Walkie-Talkie Sets. The Charger shall be Rapid Battery Charger.
- 10.2.3 The 5 Watt Walkie Talkie equipment shall be provided as per the following specification or better:

General		
1.	Frequency Range	136-174 MHz (Full Band)
2.	No. of Channels	16 Channels or more

3.	Channel Spacing	12.5 KHz
4.	Frequency spread	5 MHz or more without degradation in Tx/Rx specifications.
5.	Frequency Stability	5 PPM or better
6.	Type of Operation	Simplex press to talk with built in condenser microphone and speaker
7	Type of Antenna	Helical Antenna suitable for Frequency Range specified.
8.	Speaker	Internal Speaker as well as Socket for External Speaker shall be provided (The Internal Speaker shall be cut-off when External Speaker is used).
9.	Output Impedance	50 Ω
10	Protection	(i) Reverse Polarity protection shall be provided. (ii) The final transistor shall be protected against high VSWR
11.	Power Source	2000 mAH 7.2-7.4 V, NiMH or Li-Ion Battery.
12.	Weight	600 g Maximum with Battery.
Transmitter		
1.	RF Power output	1-5 Watt RF power output switch able/ programmable
2.	Frequency Deviation	+/- 2.5 KHz Max.
4.	Modulation Distortion	Better than 5%
5.	Modulation Fidelity	Within +1, -3 dB of 6 dB/Octave
6.	Spurious & Harmonics supersession	Better than -36 dBm (0.25 μ W)
7.	VSWR	Better than 1.5
Receiver		
1.	Sensitivity	0.3 μ V at 12 dB SINAD
3.	Squelch Sensitivity	0.25 micro V or better at threshold.
4.	Selectivity	Better than 60 dB
5.	Image Rejection	Better than 65 dB
6.	Audio Output	Better than 250mW with less than 5% distortion at 1 KHz reference measured at specified AF output.
7.	Audio Response	+1, -3 dB or 6dB/ Octave de-emphasis characteristics from 300 Hz to 2700 Hz. With 1 KHz reference.
Feature-wise Configurations		

1.	Simple Press-to-Talk
2.	Protection against high VSWR
3.	Low Battery Alert
4.	Capable of VOX for Hands-free Operation.
5.	PTT ID Encode
6.	CTCSS/DCS
7.	Busy Channel Lockout
8.	Channel Scanning with Call Quieting facility
9.	2-Tone/DTMF/5-Tone Signalling
10.	Selective Call Decode.
11.	Capable of being killed / Unkilled.

10.3 General Requirements

10.3.1 All equipment shall be suitable for operation in the following environmental conditions.

Operating Temperature Range	:	-5° C to +55° C
Storage Temperature Range	:	-10° C to +70° C
Relative Humidity	:	95% Max +40° C non condensing.

Environmental Test Reports in respect of main equipment of 25 Watt VHF Transceivers and 5 Watt VHF Walkie-Talkie Sets proposed to be supplied shall be submitted along with Design Submissions for review by the Engineer. Environmental Test Reports for environmental test sequence as under at a specified laboratory shall cover following tests:

S No	Test	Test to be conducted as per ISO-9000	
a)	Dry Test	Part-III/SEC.5/1977	55° C(+/-) 2° C. RH<50% Duration 16 Hr.
b)	Dump Heat (Cyclic) Test	Part-V/SEC.2/Variant1/1981	40°C(+/-) 2° C, RH 95%. Two cycles of 24 (12+12) hrs each.
c)	Cold Test	Part-II/SEC. 4/1977	(-)10° C +/-3° C, Duration 16 Hrs.
d)	Drop test (in packed)	Part-VII/SEC.3/1979	Six drops one on each face, Height of all 1000mm in case of hand held items and 500mm in case of Other items.
e)	Vibration Test	Part VIII/1981	12 Hrs, 4 hours along each axis, at 15-150 Hz and with amplitude of 0.15 mm/2g
f)	Storage Test	Part III/SEC.5/1977 & Part II/SEC.4/1977	-10° C for 5 hours. Then raise the temperature to 70° C for 16 hrs.
g)	Bump test	Part VII/SEC.2/1979	4000 bumps at peak

S No	Test	Test to be conducted as per ISO-9000	
			acceleration of 400m/s.sq.

10.3.2 Environmental Test Report with equivalent or superior conditions would be acceptable.

10.3.3 In case of Transceivers, the functional tests shall be carried out at the commencement and at the conclusion of the environmental test sequence as above. The functional tests and permissible degradation shall be as under:

- (1) RF Power output : It shall not degrade by more than 1 dB
- (2) Receiver Sensitivity : It shall not degrade by more than 1 dB
- (3) Frequency Stability : No degradation shall be noticed on any frequency.

10.3.4 In the case of batteries, battery chargers and power supplies, the functional tests shall be carried out at the conclusion of the environmental test sequence as above. The functional tests and permissible degradation shall be as under:

- (1) Battery: No degradation in battery capacity
- (2) Battery Charger: No degradation in output voltage.
- (3) Power Supplies: No degradation in output Voltage.

*** End of chapter 10 ***

CHAPTER 11 - VIDEO SURVEILLANCE SYSTEM REQUIREMENTS

11.1 General

- 11.1.1 The Video Surveillance Cameras shall be provided to provide effective real time video surveillance of TSS from OCC.
- 11.1.2 Video Surveillance System shall be end to end IP based system with IP Fixed Box Type Video Cameras, Video Management & Recording Servers and LED Backlit Monitors.
- 11.1.3 Video Surveillance System shall provide on-line display of video images on LED Backlit Monitors located in the Operation Control Theatre in OCC Building Complex. Video Surveillance System shall have Control Equipment located in the Telecommunication Equipment Room (TER) in OCC.
- 11.1.4 If feasible Contractor may upgrade/augment/reconfigure the LED Backlit Monitors, Video Management & Recording Servers, External Storage Device etc. provided under Contract Packages CP-104 to meet the requirement of this Particular Specifications.
- 11.1.5 Whenever existing equipment provided under Contract Packages CP-104 are upgraded/augmented to meet the requirement of this Particular Specifications, the available provision for redundancy in existing equipment shall not be compromised and subsequent to upgradation/augmentation they shall meet the Technical Requirement and Performance Requirement as stipulated in this Particular Specifications.

11.2 Scope of Supply

- 11.2.1 The Scope of Supply for the IP based Video Surveillance System shall include, but not be limited to, the following:
- (1) HD Fixed Box Type IP Colour Video Cameras complete with Vari-focal Lenses, Housing and Mounting Arrangement;
 - (2) 20" Screen Size Full HD LED Backlit Colour Display Unit with PC Workstation for Viewing and Monitoring;
 - (3) 20" HD LED Backlit Colour Monitors with PC Workstation for Viewing, Monitoring and System Management;
 - (4) Server Hardware for Video Management and Recording;
 - (5) RAID -5 External Storage Device;
 - (6) Layer-2 Switches;
 - (7) Video Management and Video Recording Software and Perpetual Licenses;
 - (8) Graphic User Interface Client Software;
 - (9) Equipment Cabinet, Racks etc as required;
 - (10) Power and Data Cables, Power Supplies, Cabling and Earthing Accessories including Termination Protection Devices;
 - (11) Contract Spares; and
 - (12) Any other equipment's/materials/software as required for completion of the Contract.

11.2.2 Scope of Services

The Contractor shall co-ordinate with Employer to decide location of cameras and other details during design and installation of Video Surveillance System.

11.3 System Requirements

11.3.1 General

- 11.3.1.1 The Video Surveillance System shall provide monitoring & recording of Colour Video in Real Time.
- 11.3.1.2 The IP Fixed Video Cameras shall be strategically placed to ensure 100% coverage of Main Entrances Gate, Incoming Bay Area, Outgoing Bay Area, Transformer Area & Power Supply Control Room Building Area of TSS.
- 11.3.2 Each camera shall have a video at HD (High Definition 1280X720p) resolution and 25 FPS (Frames per Second) and a dual stream capability such that viewing and recording at different resolutions and FPS are possible.

- 11.3.3 Traction Power Controller shall be provided one Client PC Workstation with 20" Full HD LED Backlit Colour Monitors for Viewing, Monitoring and System Management. If feasible Contractor may upgrade/augment/reconfigure the Client PC Workstation with 20" Full HD LED Backlit Colour Monitors provided for Traction Power Controller at OCC under Contract Packages CP-104 to meet the requirement of this Particular Specifications.
- 11.3.4 Video Surveillance System and Cameras shall offer dual streams of H.264 Video Compression Standards.
- 11.3.5 **Display Requirements:** The general guideline for displaying the full frame image height of a 1.8m tall person standing upright, within the IP Fixed Video Cameras Coverage Area, on any Monitor shall not be less than one tenth of the screen for both Fixed Lens and Zoom Lens Cameras at the shortest Focal Length. No image degradation shall be caused on the Monitors owing to any external sources of interference including, distortion of the image at the periphery of the screen, rotation of image, mis-convergence of colour image and change of colours on the screen due to changing of external magnetic field level.
- 11.3.6 **Video Recording:** The Video Recorder shall be capable of operation for 24 hours per day, 365 days a year. The recording shall be preferably stored for at least 30 days at HD Resolution, 12 FPS. The Video Recorder System should, however, be capable of recording at HD Resolution, 25 FPS for all Cameras. The Storage Device for recording shall be with RAID 5 Protection.
- 11.3.6.1 In the event of recording operation being interrupted, for example by power failure, it shall automatically resume recording, on resumption of power supply, of all the cameras it was recording prior to the interruption.
- 11.3.6.2 **Video Retrieving:** It shall be possible for the Traction Power Controller in the OCC to retrieve recorded videos. All recordings shall have the associated time and date stamped information superimposed onto the video image.
- 11.3.7 If feasible Contractor may upgrade/augment/reconfigure the Video Management & Recording Servers, External Storage Device, Data Networking Equipment etc. provided under Contract Packages CP-104 to meet the requirement of this Particular Specifications.
- 11.4 Performance Requirements**
- The following performance requirements for the Video Surveillance System shall be complied:
- 11.4.1 Reliability Requirements**
- The Contractor shall furnish to the Engineer for the following Sub-Systems/Equipments, the reliability figures i.e. MTBF Hours from the OEMs:
- (1) Control and Management Equipment;
 - (2) Fixed Cameras;
 - (3) LED Backlit Monitors;
 - (4) PC Workstation;
 - (5) Video Recording Equipment;
 - (6) Switches; and
 - (7) Other equipment's used in the Video Surveillance System.
- 11.4.1.1 The inability to perform any required function, the occurrence of unexpected action or the degradation of performance below the Specifications shall be considered as a Failure.
- 11.4.1.2 MTBF shall be the average Operating Time accumulated by the Total Population of Identical Items between failures.
- 11.4.2 Availability Requirements**
- 11.4.2.1 The contractor shall implement a RAMS Plan defined in accordance with IEC 62278. Any degraded mode of operation or re-configuration functions provided by the Video Surveillance System shall not be included in the determination of the system availability.
- 11.4.2.2 The conditions which shall be considered as failures shall include, but not be limited to:
- (1) failure of LED Backlit Monitor of Traction Power Controller in OCC;
 - (2) failure of any Switch or Client PC Workstation;

- (3) failure of Video Recording Equipment;
- (4) all failure conditions leading to the loss of video signal for more than 10% of Video Surveillance System Cameras.

11.4.2.3 The Video Surveillance System shall have an overall availability of better than 99.95%.

11.4.3 Maintainability Requirements

11.4.3.1 The Contractor shall comply with the maintainability requirements as specified in Clause 3.4.

11.4.3.2 The service life of the Video Surveillance System (equipment) shall not be less than 15 years. Service life of all types of cables shall not be less than 25 years.

11.4.4 System Safety Requirements

11.4.4.1 All equipment must comply with and be installed in conformance with IEC 60065 IEC 60364 or equivalent National Electric Code/Uniform Building Code of safety standards.

11.4.4.2 All metallic enclosures shall be provided with an earth terminal and connected to earth.

11.5 Technical requirements

11.5.1 General

11.5.1.1 Proposed Video Surveillance System shall be based on Non Proprietary Open Standard Architecture affording interoperability of hardware, software, OS, networking etc.

11.5.1.2 All control equipment e.g. servers, storage devices etc shall be Rack mounted. No equipment other than cameras, field switches, cables and their junction boxes shall be installed outside the TER. Switches in outdoor areas should be installed in proper IP 66 vandal proof housing.

11.5.1.3 The internal clock for the Video Surveillance System equipment shall be synchronised to within 1 second of the Master Clock System at all times.

11.5.1.4 All equipment of Video Surveillance System shall work from 180 to 270 V 50 ±3% Hz AC single phase supply from UPS. Appropriate AC Supply Distribution Cubicles/Racks complying to IP54 with 20% spare capacity shall be provided for this. Equipment shall be capable of withstanding ripple of 2%.

11.5.1.5 Power Cable shall be laid from AC Supply Distribution Cubicles/Racks to field equipments of Video Surveillance System for powering them.

11.5.1.6 CAT-6 Cable shall be laid between cameras and field switches. From field switches, optical fibre cable shall be laid to central switch. If distance between a field switch and central switch is less than 90 meters, CAT-6 Cable may also be used. The field switches should have 10/100/1000 SFP Ports for fibre interface for connectivity to central switch. All field switches shall be connected to central switch in star configuration.

11.5.2 Equipment Specific Requirements

11.5.2.1 Fixed Box Type IP Cameras

11.5.2.1.1 Fixed Box Type IP Cameras shall have following technical specifications as a minimum:

1.	Imaging Device	1/3" or 1/4" CMOS Sensor, Progressive Scan.
2.	Active Pixels	1280(H) x 720(V)
3.	Streaming	Dual, individually configurable, H.264 streams.
4.	Frame Rate	25 FPS(Maximum), configurable to 25, 12, 6, 3, 2 & 1 FPS.
5.	Video Resolution	1280X720, Configurable to 1280X720 & 640X360
6.	Video Compression	H.264
7.	Sensitivity	Scene Illumination

	<ul style="list-style-type: none"> • Colour Mode • Night Mode (Black & White) 	(at F1.2, 50 IRE & Shutter Speed 1/50). 0.5 Lux 0.05 Lux
8.	Signal to Noise Ratio	≥50 dB
9.	Shutter Speed	1 to 1/10,000
10.	Data Rate	64 Kbps to 6 Mbps
11.	Lens Mounting	CS
12.	Humidity	20% to 80% non-condensing
13.	Operating Temperature	0 °C to+ 50 °C (with or without housing)
14.	Storage	0 °C to+ 60 °C
15.	Network Connectivity	Ethernet, 10/100 BaseT PoE
16.	PoE	IEEE 802.3af compliant
17.	Automatic Gain Control	Required
18.	Automatic White Balance	Required
19.	Back light Compensation	Required
20.	Network Protocols	As required for Video Surveillance System working.
21.	Vandal-Proof Arrangement	Required for Outdoor Cameras
22.	Web server	Web Server required with embedded Operating System.
23.	Approvals	UL or EN and FCC (for Safety, EMC & Immunity)

11.5.2.1.2 Fixed Box Type IP Video Cameras shall operate on 180 to 270 V AC voltage as required as per the design and implementation.

11.5.2.1.3 Varifocal Lenses with following minimum specifications shall be used for Fixed Box Type IP Video Cameras.

1.	Focal Length	7.5-50 mm
2.	Minimum Object Distance	1 m
3.	Lens Mount	CS-Mount
4.	Iris Control	Auto, DC Control
5.	Focus Control	Manual
6.	Zoom Control	Manual
7.	Operating Temperature	0° C to +50° C
8.	Operating Humidity with camera and housing	20% to 80%, non condensing

11.5.2.1.4 Housing arrangement for Fixed Box Type IP Video Cameras shall be designed for both outdoor and indoor use as per requirement. The Housing shall either be integrated with the camera by the manufacturer or it shall be of same make as the camera. The housing shall protect camera and the lens combination and have the following minimum technical specifications and features:

1.	Windows	3mm (0.12 inch) glass
2.	Camera Mounting	Removable Camera/Lens Tray, mounted with screws
3.	Construction	Aluminium housing casing, neoprene gaskets, UV

		resistant polymer end caps.
4.	Tamper-resistance	Tamper-resistant screws for locking clasps shall be provided
5.	Enclosure Protection	IP 66/NEMA-4 or better, with inbuilt heater blower kit
6.	Approvals	UL or EN and FCC (for Safety, EMC & Immunity)
7.	Vandal Proof Arrangement	Required for Outdoor Cameras.

11.5.2.1.5 Mount for the Camera

Mounts shall be suitable for indoor and outdoor mounting units and designed for fixed cameras or camera housing installations. Mount shall have the following features:

- (1) Feed-through design for cable management;
- (2) 360° rotation and 180° tilt;
- (3) Versatile design;
- (4) Adjustable mount heads;
- (5) Corrosion-resistant finish.

11.5.2.2 **20" HD LED Backlit Colour Monitors:**

11.5.2.2.1 LED Backlit Colour Monitors shall be used in conjunction with PC Workstations for Viewing, Monitoring and System Management.

11.5.2.2.2 LED Backlit Colour Monitors shall have following minimum specifications:

1.	Viewable Display Area	20" when measured diagonally on the screen
2.	Resolution	HD 1280 X 720
3.	Contrast Ratio	500:1
4.	Video I/P	S-Video, Video/Composite Video, PC Analogue Input (RGB, D-Sub), HDMI, SVGA, VGA
5.	Display Control	Monitor control on screen display, programmable with front panel.

11.5.2.3 **PC Workstation**

11.5.2.3.1 PC Workstation shall be used with 20" HD LED Backlit Colour Monitors for System Management & General Monitoring.

11.5.2.3.2 The PC Workstations for Viewing, Monitoring and System Management shall be able to provide High Quality Graphics Display.

11.5.2.3.3 PC Workstation shall also consist of following minimum items:

- (1) HDD Interface SAS/SATA/IDE or better, RAM 4 GB upgradable upto 24 GB, OS - Windows XP Professional/ Linux or latest.
- (2) 256MB Dual DVI Graphic Card: NVIDIA NVS 295 or better.
- (3) PC Workstation should have minimum 5 PCI slots (preferably 1 PCI Express Gen 2x16 slot, 1 PCI Express Gen 1 x4 - with x8 connector, 1 PCI express Gen 2 x4 with x8 connector, 2 legacy PCI 32 bit/33 MHz).

11.5.2.4 **Server Hardware for Video Management and Recording:**

11.5.2.4.1 Server for Video Management & Recording shall be 19" rack mountable, dual Intel quad core Xeon 5520 or better processor, 2.26 GHz or better chipset, Intel High Performance 5520 Chipset Intel Quick Path Interconnect (QPI) @ maximum 5.86GT/S or better. All servers for Video Management & Recording in the OCC shall be provided with back up.

11.5.2.4.2 Server hardware for Video Management & Recording shall have the minimum following specifications:

(i)	HDD Interface	6 x 2.5" Hot plug SAS or better, Memory 6 GB ECC DDR3 SDRAM expandable upto 144 GB, OS Microsoft Windows Server 2003 Standard Edition or higher with 5 Client licenses or Linux.
(ii)	CD Drive	DVD ROM Drive
(iii)	Ethernet Card	Quad Onboard/ on slot Gigabit Ethernet with Load Balancing and Fail over Support. Remote management card with IPv6 compliance.
(iv)	Other Features	Onboard SAS Controller and SAS RAID controller for external connectivity with minimum 512 MB cache Hot-plug HDD, redundant Hot-plug power supply. 2 internal Hot-plug SCSI HDD. 1 or 2 U mounting.
(v)	HDD	146 GB x 2 RAID 1 SAS HDD, 10,000 RPM

11.5.2.4.3 Suitable database licenses should be provided as required by the solution offered by the vendor.

11.5.2.4.4 If feasible, Server Hardware for Video Management System provided under CP-104 may be upgraded/augmented/reconfigured by Contractor to meet the requirements of this Particular Specification.

11.5.2.5 Storage Device with RAID 5 Protection:

11.5.2.5.1 A protected storage device shall be provided for recording the information at OCC.

11.5.2.5.2 The storage system should have atleast 4 interfaces of FC or iSCSI across dual redundant controllers, 4 GB protected Cache (battery backed or equivalent), scalability upto minimum 120 TB raw, redundant power supplies & fans. FC HBA card should be provided in host server for connectivity in case system is provided with FC interface.

11.5.2.5.3 The storage device should support simultaneous play back and recording at full duplex operation. It should possess the capability of carrying SAS and SATA and should be accessible to the connected server.

11.5.2.5.4 The system should provide minimum 18.0 TB usable after RAID 5 configuration for every 32 cameras for storing minimum 30 days recording.

11.5.2.5.5 LED/LCD indicators shall be available for system status, power supply, fan fault, hard drives and carrier, enclosure management module.

11.5.2.5.6 RAID Configurations:

- (1) RAID levels 5
- (2) Maximum 256 virtual drives
- (3) It should provide at least one hot spare disk

11.5.2.5.7 If feasible, External Storage Device with RAID Protection provided under CP-104 may be upgraded/augmented/reconfigured by Contractor to meet the requirements of this Particular Specification

11.5.2.6 Layer-2 Switches for Field:

11.5.2.6.1 8 Port Layer-2 Switches are to be provided for field applications. These switches should have one 10/100/1000 SFP Port (fibre port) and 7 fast Ethernet Ports with RJ 45 Connectors, complying with IEEE 802.3, IEEE 803.3u and 802.3ab standard. These Layer-2 Switches should also be PoE compliant as per IEEE 802.3af.

11.5.2.6.2 Layer-2 Switches shall have minimum of 16 Gbps forwarding bandwidth at Layer-2 Switching Fabric, a minimum of 1,000 MAC address space and 6 million packets (64 Byte packets) per second forwarding rate.

- 11.5.2.6.3 All Software/Hardware/License supplied along with the Layer-2 Switches shall be supplied to the Engineer.
- 11.5.2.6.4 Layer-2 Switches shall support Telnet, SNMP (Simple Network Management Protocol) V1/V2/V3, Network Time Protocol, SSH (Secure Shell) V1/V2 and FTP (File Transfer Protocol).
- 11.5.2.6.5 Layer-2 Switches shall have console port with a RS-232 Interface for configuration and diagnostics purposes.
- 11.5.2.6.6 Ethernet output from the IP camera shall be connected to the nearest field switch through CAT 6 STP cable and the field switch shall be connected to the central switch on optical fibre cable/CAT6 STP cable.
- 11.5.2.6.7 Required numbers of Small Form-factor Pluggable (SFP) modules, compact optical transceivers used in optical communications, should be supplied along with each switch. SFP modules should comply with Multi-Source Agreement (MSA), enabling the compatibility with other vendors' equipment.

11.6 Software Requirements

11.6.1 Video Management Software

- 11.6.1.1 This shall be a highly scalable enterprise level software solution. It shall offer a complete video surveillance solution that will be scalable to required numbers of cameras that can be added on a unit-by-unit basis.
- 11.6.1.2 The video management software shall operate on open architecture and should require no proprietary hardware.
- 11.6.1.3 The user with administrative rights shall create clients (users) and give access to the software client application based on predefined user access rights.
- 11.6.1.4 The system shall allow the recording, live monitoring, playback of archived video and data simultaneously.
- 11.6.1.5 **The software shall provide the following**
 - (1) Several simultaneous live picture connections of camera in network.
 - (2) Configuration of monitoring situation (site maps and workspace).
 - (3) Programming of alarm-triggered automatic events in various alarms configuration.
 - (4) System set up with limited operation options for clearly defined surveillance tasks.
 - (5) Programming of automatic recording events on a network recorder.
- 11.6.1.6 The software shall allow display of dual H.264 video streams in real time simultaneously at different frame rates and different resolution.
- 11.6.1.7 Each camera's bit rate, frame rate and resolution shall be set independently from other cameras in the system, and altering these settings shall not affect the recording and display settings of other cameras.
- 11.6.1.8 The software shall provide automatic search and registration of components of video surveillance system on the network which can be cameras, monitors, alarm panels etc.
- 11.6.1.9 The software shall provide drag & drop functions on the system and also for set up of connection between cameras and monitors.
- 11.6.1.10 The software shall allow the following:
 - (1) Live display of cameras.
 - (2) Live display of camera sequences
 - (3) Playback of archived video
 - (4) Retrieval of archived video
 - (5) Instant Replay of live video
 - (6) Use of site maps.
 - (7) Use of Macros
 - (8) Configuration of system settings.

- 11.6.1.11 The software should be able to do video recording on any of the options viz. inbuilt hard disks on the server, direct attached storage boxes attached to servers, network attached storage, storage area network.
- 11.6.1.12 The software should be capable of handling camera and alarm icons on area maps. The area map should be configurable to pop up upon the receipt of an alarm received from a camera on the map. This can be on the same or other monitors on the PC.
- 11.6.1.13 The software shall be able to select the required recording based on the time recording was activated, the duration of recording, operator activated recording, event activated recording, scheduled recording.
- 11.6.1.14 The software shall offer a plug and play type hardware discovery service with the function of automatically discover devices as they are attached to the network.
- 11.6.1.15 The software shall provide a reporting utility for tracking for the following minimum options, Video and images shall be stored with reports for documenting events.
- (1) Alarms
 - (2) Incidents
 - (3) Operator logs
- 11.6.1.16 The software shall have the facility to export the desired portion of clipping of video from a desired date/time to another desired date/time on DVD or on any Client/Network Storage Device. Viewing of this recording shall be possible on authorized player which shall be provided by software manufacturer or in media player on computer utilizing Window environment.
- 11.6.1.17 The software database servers shall not limit the number of Video Recording Servers which can be networked together to form Video Management and Recording System.
- 11.6.1.18 The software database server shall maintain a catalog of settings for all the clients, servers, and cameras in the system. If database management & recording cannot be managed by single server, in such cases, additional server should be provided.
- 11.6.1.19 The software shall enable the client to dynamically create connections between cameras and clients and view live or recorded video on the digital VGA monitors (video, serial ports and digital I/Os).
- 11.6.1.20 The software shall provide the client seamless operation of all cameras and clients available in the system regardless of the actual connection to different Network Video Recording servers.
- 11.6.1.21 The software shall detect signal loss, low signal to noise ratio etc. and have the capability to alert the systems administrator.
- 11.6.1.22 The software shall create an audit trail of all events and user activities.
- 11.6.1.23 The software shall support a built-in Virtual Video Matrix Switcher to provide a full matrix operation of IP Video to Digital Monitors. The Virtual Matrix Switch shall have the capability of creating camera sequences with the following functionalities:
- (1) Each Sequence shall have capability up to hundreds of cameras.
 - (2) Each camera in the sequence shall have its own individual dwell time, from 1 to 60 seconds.
 - (3) Multiple users shall be able to view the same camera sequence simultaneously, not necessarily synchronized one with the other.
- 11.6.1.24 The software shall provide Alarm Management Module to set any monitor or groups of monitors to automatically display cameras in response to alarm inputs.
- 11.6.1.25 It shall be possible to search for recordings in the software by camera, date and time. If a data and time is specified, playback shall commence from that date and time. It shall be possible to playback more than one camera simultaneously.
- 11.6.1.26 The software should support at least 64 video streams concurrently. It should support atleast 4 monitors in one server/ workstation for displaying live video. It should allow minimum 5 levels of user and alarm prioritization, It should allow minimum 16 cameras to be replayed simultaneously.

- 11.6.1.27 If feasible, Video Management Software provided under CP-104 may be upgraded by Contractor to meet the requirements of this Particular Specification.
- 11.6.2 **Video Recording Software**
- 11.6.2.1 Software shall support recording of H.264 video streams. It shall support recording of video and audio for all the channels.
- 11.6.2.2 Software shall support triplex applications, recording, re-play and backup simultaneously. It shall be compatible with windows Server OS or Linux for highest performance and reliability.
- 11.6.2.3 Software shall operate on open architecture and should not require any proprietary hardware.
- 11.6.2.4 Software shall be able to record minimum 32 different video streams or more simultaneously. It shall be accessible from any PC connected to the network.
- 11.6.2.5 Software shall provide network time server function to ensure the synchronization of the video servers and the recordings.
- 11.6.2.6 The servers shall be connected to the network so that these can be placed at any location which has network access.
- 11.6.2.7 The software should be able to receive alarms of different types from equipment to start a recording.
- 11.6.2.8 The software alarm recording shall support pre-and post-alarm periods. Both can be configured in duration.
- 11.6.2.9 The software should provide a status of the available recording capacity, as well as an indication of the remaining possible recording time.
- 11.6.2.10 If feasible, Video Recording Software provided under CP-104 may be upgraded by Contractor to meet the requirements of this Particular Specification.
- 11.6.2.11 **Fault Tolerant Recording**
- 11.6.2.11.1 If software & server(s) operation are interrupted, like power disconnection and once the server(s) are restarted, these shall automatically resume recording of any cameras that were being recorded prior to the interruption.
- 11.6.2.11.2 The software shall support network fault-tolerant recording such that if the network connection between a video management server and video recording server becomes unavailable, for example through cable breakage, network congestion or WAN interruption, the system operation shall automatically recover when the connection is restored.
- 11.6.2.12 **Search & Export**
- 11.6.2.12.1 It shall be possible to search for recordings in the software by camera, date and time. If a data and time is specified, playback shall commence from that date and time. It shall be possible to playback more than one camera simultaneously.
- 11.6.2.12.2 The software shall be able to export sections of recordings to a separate Windows folder, which can then be written to CD-ROM, DVD-ROM or tape media to be played back at a location not connected to the network video management & recording network. The export process should make available a player application, which can be provided with the exported video. Export should be possible in Windows media player compatible format. Simultaneous export of multiple cameras should also be possible.
- 11.6.3 **GUI (Graphic User Interface)**
- 11.6.3.1 The GUI Software shall perform the following applications simultaneously without interfering with any of the storage server operations :
- (1) Live display of cameras.
 - (2) Live display of camera sequences.
 - (3) Playback of archived video.
 - (4) Retrieval of archived video.
 - (5) Instant replay of live video.

- (6) Use of graphical controls (maps).
- 11.6.3.2 The GUI Software shall provide an authentication mechanism, which verifies the validity of the user.
- 11.6.3.3 The GUI Software shall provide management and control over the Video Surveillance System using a standard PC Mouse and Keyboard.
- 11.6.3.4 The GUI Software shall support display, video of cameras, on 20" LED Display Unit or on 20" Monitors. The operator from the GUI Software shall be able to decide the cameras that shall be displayed on the Display Unit/Monitors.
- 11.6.3.5 The GUI Software shall enable view of 1 to 16 video tiles simultaneously on a single Display Unit/Monitor at 25 FPS per camera. It shall support display of tile views of Full Screen or Quad or 3X3 or 4X4 or 1+5 or 1+9 or 1+11 or 1+15 on each of the Display Unit/Monitor independently.
- 11.6.3.6 The GUI Software shall allow operators to view an instant replay of any camera. The operator shall be able to define the amount of time he wishes to go back from a predefined list or through a custom setup period. The operator shall be able to control the playback with play, pause, forward, and speed buttons.
- 11.6.3.7 The operator shall be able to choose and trigger following minimum action from site map:
- (1) View camera in a Video Tile.
 - (2) View map or procedure in a Video Tile.
- 11.6.3.8 The GUI Software shall display all cameras attached to the Video Surveillance System regardless of their physical location on the network.
- 11.6.3.9 The GUI Software shall display all camera sequences created in the system. It shall allow operators to control (pause/play, skip forwards, skip backwards) camera sequences, without affecting other operators' ability to view and control the same sequence.
- 11.6.3.10 The GUI Software shall display all cameras, sequences and users in a logical tree. The GUI Software operator shall be able to drag and drop a camera or camera sequence from a tree of cameras into any video tile for live viewing.
- 11.6.3.11 The GUI Software shall support graphical site representation (map) functionality, where digital maps are used to represent the physical location of cameras throughout facility. The maps shall have the ability to contain hyperlinks to create a hierarchy of interlinked maps.
- 11.6.3.12 The operator shall be able to drag and drop a camera from a map into a video tile for live viewing in the same browser without opening a new browser.
- 11.6.3.13 The GUI software shall support Digital Zoom on a Fixed camera's live video streams.

11.7 System Expansion

- 11.7.1 Video Surveillance System equipment shall as a minimum be modularly expandable to an expansion capacity of 50% by the addition of cards and/or modules without the need to replace the installed hardware and software of the system.
- 11.7.2 Wherever the equipment of Video Surveillance System being provided under Contract Package CP-104 is being upgraded/augmented/reconfigured, this upgradation/augmentation/reconfiguration shall not in any way utilize available provision of expansion.

(End of Chapter 11)

CHAPTER 12 - 48 V DC BATTERY BACKUP SYSTEM REQUIREMENTS

12.1 General

- 12.1.1 The 48 V DC Battery Backup System at each TER, shall be sized to power its full load including, but not limited to, Mobile Train Radio System, VHF Communication System, Telephone System, Data Networking System and OFC System. The VHF Communication System shall work on 12 V DC.
- 12.1.2 230 V AC Power Supply for 48 V DC Battery Backup System shall be provided as detailed in Particular Specification for Signalling Works.
- 12.1.3 The Battery Backup System shall include Line Protecting Devices, Battery Chargers, Battery Banks and Load Distribution Arrangement. The Battery Banks shall consist of Valve Regulated Lead Acid Maintenance Free Cells.

12.2 Design Requirements

- 12.2.1 Design shall take into consideration the voltage drop between the Power Supply Source and the Telecommunication System Load individually at each location (OCC, Stations, Auto Locations Huts, GSM-R Locations etc.).
- 12.2.2 Provision of suitable Earth Leakage Detector and Alarms shall be made individually at each location (OCC, Station, Auto Location Huts, GSM-R Locations etc.).

12.3 Technical Requirements

- 12.3.1 For high availability, the Battery Backup System at each location shall include 2x100% SMPS based 48 V Battery Chargers in Load Sharing Mode with individual 48 V Battery Bank for each Battery Charger.
- 12.3.2 Each of the two Battery Banks shall provide busy hour reserve of four(4) hours, for all Telecommunication Equipment powered by 48 V DC Battery Backup System, at each location (OCC, Station, Auto Location Huts, GSM-R Locations etc.).
- 12.3.3 For sizing the battery capacity at each location, relevant factors like K Factor (as applicable), Ageing Factor (1.25), Design Margin (1.1), Temperature Factor and ECV (as applicable for the type of battery) shall be considered. In addition spare capacity of 25% shall be provided to cater for any requirement of additional equipment at that location.
- 12.3.4 Battery Chargers shall be as per RDSO Specifications RDSO/SPN/TL/23/99 Version 4.0 with Latest Amendments. Each Charger system shall be sized to meet full load as mentioned above and simultaneously charge the fully discharged Battery Bank connected to it at 10 Hour Rate of Charge for the battery. The Battery Chargers shall be procured from RDSO Approved Sources only. The design shall ensure that the failure of a single component does not cause failure of the 48 V DC Battery Backup System.
- 12.3.5 All Battery Cells shall be of the Valve Regulated Lead Acid Maintenance Free type to RDSO specifications IRS S93-96 with Latest Amendments for capacities up to and including 500 AH and to TEC Specifications No.GR/BAT-01/03 March 2004 with Latest Amendments for capacities beyond 500 AH. The life of these Battery Cells shall not be less than 7 years.
- 12.3.6 There shall be no break in the 48 V DC Power Supply to the Telecommunication Systems during failure of one of the Battery Charger with Battery Bank.
- 12.3.7 The following data shall apply to 48 V DC Battery Backup System:
- (1) Input Voltage Range (Single phase): 230 V AC (+10 %, - 20%)
 - (2) Input frequency: 50 Hz +/- 5%
 - (3) Output Current: As required for each location
- 12.3.8 Battery Backup System functions shall include:
- (1) Low Voltage Battery Disconnection (LVD)
 - (2) Battery Disconnection Pre-Alarm
 - (3) Battery Current Limiting
 - (4) Temperature Compensated Charging

(5) Test Mode Facility

12.3.9 System Protection shall include

- (1) High Voltage Input Disconnection (HVD)
- (2) Lightning Protection/Surge Protection
- (3) Transient Absorbers for Component Protection
- (4) Load Fuses/MCB's as required
- (5) Battery Fuses /MCB's as required

12.3.10 Alarms for the Battery Backup System shall be implemented through Network Management System (NMS) in the TER at OCC. If feasible Network Management system for alarms for 48V DC Battery Backup system provided under Contract Package CP-104 may be upgraded/ augmented to meet this requirement. Contractor shall extend these alarms using appropriate interface such as RS-232, RS-485, TCP/IP etc. Following Alarms shall be provided on the NMS in the TER at OCC for each of the 48 V DC Battery Backup System at all locations.

- (1) Mains Available/Mains Not Available
- (2) Mains Out of Range
- (3) Float Mode
- (4) Charge Mode
- (5) System Overload
- (6) Rectifier Modules Fail (one or more than one)
- (7) Battery Cut-Off Pre-Alarm
- (8) Battery Fail/Isolated

*** End of Chapter 12 ***

CHAPTER 13 - INSTALLATION, EARTHING, LIGHTNING AND SURGE PROTECTION

13.1 General

- 13.1.1 The Contractor shall supervise all installation of the Works and shall ensure all technical, safety and quality matters adhered to the Design reviewed by the Engineer.
- 13.1.2 The Contractor shall take every precaution to protect existing equipment and facilities on Site from damage, and shall make good any damage caused. Care shall also be taken not to interfere with the operation of existing equipment.
- 13.1.3 The Contractor shall provide all necessary and sufficient resources such as tools, test instruments, spares, equipment, manpower and communication facilities to complete all the installation activities.
- 13.1.4 The Contractor shall ensure his staff are competent and possess all the necessary skills to carry out the installation in a proper and safe manner.
- 13.1.5 The Contractor shall carry out site surveys to ensure sufficient knowledge on the Site before submitting the relevant installation design & drawings and other installation related submissions to the Engineer for review.
- 13.1.6 The Contractor shall submit calculations, if required, by the Engineer to demonstrate that the proposed brackets and mounting methods are sufficient to withstand the wind loading for the equipment.
- 13.1.7 The Contractor shall submit installation method statements for each type of installation activities at least three months before the commencement of the activity to the Engineer for review.
- 13.1.8 The installation method statement shall include the details on the methods and procedures of installation, site arrangement, manpower resources, equipment and tools required. Drawings shall be included to illustrate the proposed installation details.
- 13.1.9 All installation activities shall commence only after the method statement and related submissions have been reviewed without objection by the Engineer.
- 13.1.10 The Contractor shall assign competent site supervisors for each work site to be responsible for all site-related matters.
- 13.1.11 The Contractor shall carry out regular site audit on both technical and safety matters and maintain records of the site audits. The Contractor shall make these records available to the Engineer for inspection upon request.

13.2 Installation Programme

- 13.2.1 The Contractor shall prepare Installation Programme as per the requirement listed in General Specifications and this Particular Specification. The Contractor shall submit the Installation Programme for review by the Engineer. This Installation Programme shall take into account the following:
- (1) Installation schedule
 - (2) Milestones
 - (3) Site Access
 - (4) Interfacing with relevant Project Contractors
 - (5) Interfacing with Indian Railway at the junction stations.
- 13.2.2 The Contractor shall co-ordinate with relevant Project Contractors to agree the date of access to the physical areas to carry out installation activities.
- 13.2.3 The Contractor shall highlight in his Installation Programme any items, materials, equipment, resources and supports to be provided by the Engineer with dates, duration and location.
- 13.2.4 The Contractor shall highlight in his Installation Programme all relevant constraints, which may affect the Installation Programme, for the Engineer's attention.

- 13.2.5 The Contractor shall include dependencies between relevant activities in the Installation Programme.
- 13.2.6 The Contractor shall ensure sufficient floats or slacks in all activities and avoid critical paths built in his Installation Programme. In case critical paths cannot be avoided, the Contractor shall take adequate measures to complete all critical paths activities in time and also highlight these critical paths for the Engineer's attention.
- 13.2.7 The Contractor shall propose contingency plan to ensure all the milestones can be met in case there is slippage in the installation activities.
- 13.2.8 Any subsequent changes in the reviewed Installation Programme shall be submitted to the Engineer for review.

13.3 Installation Works in Equipment Rooms

- 13.3.1 Telecommunication Equipment Room at New Boraki Station, IMSD and Residential Colonies (if required) will be constructed by CST Contractor to install the Telecommunication Equipment.
- 13.3.2 Telecom Power Supply Equipment Rooms at New Boraki Station, IMSD and Residential Colonies (if required) will be constructed by CST Contractor to install the Telecom Power Supply Equipment.
- 13.3.3 Telecommunication Equipment Room/Telecom Power Supply Equipment Room at Auto Location Huts, Interfacing IR Stations, GSM-R Locations, TSS, SSPs and any other location as required shall be constructed by Contractor. These rooms shall be preferably be co-located with the Signalling Equipment Room/Signalling Power Supply Equipment Room. At these co-located locations a common S&T Power Supply Equipment Room for housing Signalling Power Supply Equipment as well as Telecom Power Supply Equipment shall be provided with the approval of the Engineer.
- 13.3.4 Electric Power for Telecom System upto Main AC Distribution Panel common for Signalling & Telecom Systems shall be drawn as covered in Particular Specification for Signalling Works. From this Main AC Distribution Panel, electric power for Telecom System shall be taken to Telecom AC Distribution Panel for distribution to Telecom Power Supply Equipment and Telecom Equipment.
- 13.3.5 48V DC Power Supply from 48 V DC Battery Backup System shall be taken to DC Distribution Panel for further distribution to Telecom Equipment.
- 13.3.6 Provision of Lighting, Power Outlets, Fans, Ventilator and Air-Circulation shall be made in accordance with Chapter 17- Interface Requirements in this Particular specification.
- 13.3.7 All floor-mounted equipment cabinets at the equipment rooms shall be securely bolted to floor/ground, properly aligned and levelled.
- 13.3.8 All wall-mounted equipment shall be installed at appropriate height to avoid any hazards to the person passing by. The Contractor shall ensure that the wall is of sufficient strength to hold the wall-mounted equipment in a secure and safe manner.
- 13.3.9 The floor mounted equipment cabinets shall be arranged in the way to allow sufficient space at the front and rear side of the cabinets for maintenance access. Sufficient space shall also be allowed for front maintenance access of the wall mounted equipment.
- 13.3.10 The equipment layout within the equipment room shall be designed to allow sufficient clearance for escape out of the equipment rooms in case of emergency.
- 13.3.11 All cable and wires inside the cabinets shall be housed in appropriate cable conduits or tied neatly along the side of cabinets. They shall not cause any obstruction to the access of equipment within.
- 13.3.12 All optical cable fibres which run outside shall be contained in protective conduits.
- 13.3.13 Smoke and Fire Detection System shall be provided in all Telecom Equipment Rooms and Telecom Power Supply Equipment Rooms with facility of alarm generation at Station and OCC, as covered under Particular Specifications – E&M and Associated Works.

- 13.3.14 The Contractor shall submit the following to the Engineer for review at least three months before the commencement of the installation inside the equipment room:
- (1) drawings showing the equipment layouts and positions of the racks, cabinets and enclosures;
 - (2) racks, cabinets layout drawings showing the arrangement of individual module;
 - (3) specifications, sample of all the mounting brackets and accessories;
 - (4) equipment mounting and installation methods;
 - (5) schematic diagrams and wiring diagrams of the System;
 - (6) electrical distribution schematics within each equipment room including the earthing details; and
 - (7) cable route diagrams for cables within each equipment room.
- 13.3.15 Installation works inside the equipment rooms shall be carried only after these submissions have been reviewed without objection by the Engineer.

13.4 Installation Works within Buildings

- 13.4.1 The Contractor shall provide all necessary mounting brackets and accessories for installation of all indoor Telecommunication Equipment as covered in this Particular Specification.
- 13.4.2 All the mounting brackets and accessories shall be corrosion resistant, aesthetically designed to match with all architectural finishes and of sufficient strength to mount the equipment securely.
- 13.4.3 All the cable trays/trunks/conduits for cable laying between equipment rooms and indoor telecommunication equipment shall be provided by the Contractor. The size of trays/trunks/conduits shall be so selected to ensure that cables shall not occupy cross-sectional space in excess of 50%.
- 13.4.4 After conduits have been laid, they shall be thoroughly cleaned by a mandrel of diameter slightly less than the conduits being drawn through. Subsequently a draw wire of galvanized steel shall be left in each conduit to facilitate the drawing of cables. The conduits ends shall be sealed temporarily to prevent the entry of foreign matter.
- 13.4.5 The Contractor shall submit the following to the Engineer for review at least three months before the commencement of the installation activities:
- (1) specifications, sample of all the mounting brackets and accessories;
 - (2) equipment mounting and installation methods;
 - (3) schematic diagrams and wiring diagrams of the System;
 - (4) cable trays/trunks/conduits route plan within building showing cross-sectional occupancy; and
 - (5) cable route diagrams for cable within buildings.
- 13.4.6 Installation works within the building shall be carried only after these submissions have been reviewed without objection by the Engineer.

13.5 Outdoor Installation Works

- 13.5.1 The Contractor shall provide all necessary mounting brackets and accessories for installation of all outdoor telecommunication equipment as covered in this Particular Specification.
- 13.5.2 All the mounting brackets and accessories shall be corrosion resistant, aesthetically designed to match with all architectural finishes and of sufficient strength to mount the equipment securely.
- 13.5.3 All the cable ducts/troughs/trenches or cable trays/trunks/conduits for cable laying between equipment rooms and outdoor telecommunication equipment shall be provided by the Contractor.

- 13.5.4 The Contractor shall submit the following to the Engineer for review at least three months before the commencement of the installation activities:
- (1) specifications, sample of all the mounting brackets and accessories;
 - (2) equipment mounting and installation methods; and
 - (3) schematic diagrams and wiring diagrams of the System.
- 13.5.5 If the equipment is installed at location exposing to direct sunlight, the equipment, mounting brackets, cables and accessories shall be made of materials which are resistant to ultra violet rays.
- 13.5.6 All trackside equipment and the mounting method shall be designed in the way to minimise the frequency of preventive maintenance.
- 13.6 Cab Radio Installation**
- 13.6.1 Cab Radio to be installed in rolling stocks shall be identified by Engineer and informed to Contractor during Design Stage.
- 13.6.2 The mounting of the Cab Radio and its sub-assemblies shall be designed to facilitate ease of maintenance.
- 13.6.3 All cabling and termination shall adopt standard wiring practice.
- 13.6.4 Cab Radio installation shall be rugged and capable of withstanding vibrations expected in such type of EMUs. Information on expected level of vibration may be obtained from the Engineer. The installation shall comply with EN61373, EN50155, EN 50121-3-2),
- 13.6.5 The Contractor shall submit the following to the Engineer for review at least 3 months before the commencement of Cab Radio installation in the rolling stocks:
- (1) Drawings showing equipment layout, racks, cabinets and enclosures. This shall include the mounting arrangement of the antenna on the rolling stocks. Racks & Cabinet layout drawings showing the arrangements of individual modules;
 - (2) Schematic diagrams and wiring diagrams of the System;
 - (3) Electric power requirements, wiring and earthing arrangements; and
 - (4) Inter cab cabling arrangements;
- 13.6.6 Installation Works in the cabs and inter cab wiring shall be carried out after the submissions have been reviewed without objection by the Engineer.
- 13.7 Cabling**
- 13.7.1 All Outdoor Cables (Optical Fibre Cable inside HDPE Duct, Jelly Filled Telecom Quad Cable & PIJF Telephone Cables) shall be laid within DFCC boundary and as far away from the track as possible. If it is necessary to lay cable outside the DFCC boundary, permission shall be obtained in advance from the concerned authority. It shall also be ensured that Jelly Filled Telecom Quad Cable and PIJF Telephone Cables shall not be laid between EDFC Track and Indian Railway Track.
- 13.7.2 The Contractor shall prepare a Cable Route Plan in consultation with Civil/Track Contractor and get it approved from the Engineer before starting the trenching work.
- 13.7.3 All Ducts/Troughs/Trenches for outdoor cable laying, except at Concrete Bridges & Culverts, shall be provided by the Contractor.
- 13.7.4 Outdoor Cables in trench shall be laid as per Chapter XIII of Indian Railway Telecommunication Manual. Outdoor Cables shall be laid in a trench with depth of 1.2 metre from the natural earth profile or from the rail level whichever is lower and suitably protected with bricks. If it is inescapable in some sections to have both trenches (for Optical Fibre Cable route diversity) at same side of DFCC Track, one trench which is farthest from DFCC Track shall be of 1.7 meter depth from the natural earth profile.
- 13.7.5 Electrical Cables (Low Tension & High Tension) shall not be laid in same trench along with Outdoor Telecommunication Cables. Minimum separation between Electrical Cables and Outdoor Telecommunication Cables shall be maintained as specified in Indian Railway Telecommunication Manual.

- 13.7.6 Outdoor Signalling Cables and Outdoor Telecommunication Cables shall not be laid in same trench. If it is inescapable to lay Signalling Cables and Outdoor Telecommunication Cables in same trench, suitable separation shall be provided between the two as per the requirement of PS-Signalling Works, IRSEM and Indian Railway Telecommunication Manual and approved by the Engineer.
- 13.7.7 Outdoor Cables in rocky areas shall be laid as per Chapter XIII of Indian Railway Telecommunication Manual.
- 13.7.8 On Concrete Bridges & Culverts, duct on the both side of Railway Tracks will be provided by Civil Structure & Track Contractor for laying of cables. All Outdoor Telecommunication Cables (Optical Fibre Cable inside HDPE Duct, Jelly Filled Telecom Quad Cable & PIJF Telephone Cables) on these Concrete Bridges & Culverts shall be laid inside DWC Pipes. Entry/Exit of the Cables to/from Bridges & Culverts shall be suitably protected as approved by the Engineer. The Contractor shall carry out necessary co-ordination with Civil, Structure & Track Contractor in this matter.
- 13.7.9 Cable laid in the slope of track formation shall be laid in Double Wall Corrugated Pipes. It shall be so laid to maintain a continuous depth of 1 meter (top of DWC Pipe) from the nearest ground level. The slope of track formation shall be restored to its original condition after laying of cables.
- 13.7.10 Following principles for laying of cables shall be adopted during Track/Road Crossings.
- (1) The cable crosses the track/road at right angles.
 - (2) The cable does not cross the track under points and crossings.
 - (3) Boring or Trenchless technique shall be used while cable crosses the track/road.
 - (4) The cable is laid in HDPE Pipe of minimum 6 mm wall thickness/Double Wall Corrugated HDPE Pipes while crossing the track/road.
 - (5) The cables are laid at a depth of 1.2 metre below the normal ground level or rail level, whichever is lower.
 - (6) Track formation/road surface shall be restored to its original condition after laying of cables.
- 13.7.11 Optical Fibre Cable shall be laid in Permanently Lubricated HDPE Ducts. These Permanently Lubricated HDPE Ducts shall be laid from one Telecommunication Equipment Room to other Telecommunication Equipment Rooms. At Track/Road Crossing these HDPE Ducts shall be laid inside DWC HDPE Pipes/HDPE Pipe of minimum 6 mm wall thickness. Straight Joints for Optical Fibre Cable shall be as per Chapter XIII of Indian Railway Telecommunication Manual.
- 13.7.12 Before commencing work on any part of the Site, the Contractor shall ascertain that the Engineer and also, where applicable, the local and statutory authorities or other bodies/persons concerned have reviewed each cable route without objection. The Contractor shall further ensure that all necessary permits in such cases have been obtained and notices served
- 13.7.13 The Contractor shall provide his own brackets and clips to secure all the cables at an adequate interval. Where cables are to be laid in troughs, the Contractor shall remove and re-instate trough covers prior to and after cable installation.
- 13.7.14 A labelling scheme shall be applied for all cables installed. Each cable shall be uniquely identified. Labels shall be tied at both ends, at entry and exit points of cable trays, ducts and trenches and at appropriate locations where necessary. Type of labels to be used shall be got approved by the Engineer.
- 13.7.15 Cable drums shall always be mounted on jack and rotated for uncoiling and paying out of cable. Cable shall not be pulled for this purpose.
- 13.7.16 Cable drum shall never be kept on its side and cable uncoiled. Since this can result in twisting of cable conductors resulting in damage to them, any such instance noticed shall result in the following liabilities on the Contractor:
- (1) Remove such laid cable and cut into pieces of scrap of about 2 metres each;
 - (2) Lay new cable in lieu;

- 13.7.17 The installation and handling of cables shall be undertaken at all times by adequate staff suitably trained and supplied with all necessary plant, equipment and tools. The arrangement of the cables and all methods of laying shall be planned to provide an orderly formation, free from unnecessary bends and crossings.
- 13.7.18 Cables in any trough/duct or tray/trunk/conduits shall not occupy cross-sectional space in excess of 50%.
- 13.7.19 At no location shall the cable be bent with a radius lower than the minimum radius recommended by the manufacturers. Sharp edges shall be avoided.
- 13.7.20 Every precaution shall be taken to ensure that cables and equipment are not installed in a manner or under conditions likely to cause electrolytic or other corrosive action or damage to, or be detrimental to, the performance of the cables and equipment during operation.
- 13.7.21 Tail cables shall be mechanically protected to avoid being damaged from track side maintenance activities and shall be immune to any malfunction from electromagnetic interference.
- 13.7.22 All cables shall be adequately rated for their duties. All power cables shall be able to withstand full load current for peak operation when the equipment is at its ultimate capacity.
- 13.7.23 Unused cable cores/pairs of multi-core/pair cables shall also be terminated and marked so.
- 13.7.24 Underground Cable Route shall be identified by Electronic Cable Markers directly buried inside the trench with the approval of the Engineer.
- 13.7.25 The Contractor shall ensure that the maximum length of parallelism is suitable to the requirement of 25 KV AC AT Feeding Traction of DFCC and 25 KV AC Traction of nearby IR and shall meet the EMC/EMI requirements of individual equipment and system as a whole. The Contractor shall also ensure that due to parallelism of High Tension Lines with telecom circuits hazardous touch potential is not created.
- 13.7.26 The Outdoor Cables (Jelly Filled Telecom Quad Cable & PIJF Telephone Cables) in sufficient spare lengths (minimum 10 meters) shall be kept coiled in a circle of suitable diameter at 1.0 meter depth before being taken into TER /Location Boxes for termination. Such coils of cables in pits shall be adequately covered to provide protection against damage and theft.
- 13.7.27 All the cable entry into TER/Location Boxes etc. shall be suitably sealed to prevent entry of rodents etc.
- 13.7.28 Selection of cables and connectors shall be appropriate to their function. The Contractor must be able to demonstrate satisfactory usage of the type of cables proposed for use under tropical conditions, be able to comply fully with the specifications herein.
- 13.7.29 For Metallic Armour of the Optical Fibre Cable, Jelly Filled Telecom Quad Cable & PIJF Telephone Cables an earthing and gapping policy shall be incorporated into an overall earthing policy as reviewed without objection by the Engineer.
- 13.7.30 A correctly coloured fibre splice protector shall be used to enclose each individual splice. Each fibre splice shall be tested to ensure correct fibre continuity and splice loss.
- 13.7.31 **HDPE Duct**
- (1) 40/33 mm HDPE duct conforming to TEC GR No. GR/TX/CDS-008/03/March 11 with latest amendment shall be used.
 - (2) The Duct shall be bright Yellow in colour. The Duct shall be supplied in length of 1000+/- 100 meters.
 - (3) Every meter of the Duct shall be marked, in 'Indelible black Ink', with the following (size of lettering 6-8mm):
 - (a) DFCCIL
 - (b) PLBE HDPE Duct 40/33 mm
 - (c) Date/Month/Year of production
 - (d) Name of the Manufacturing firm

13.8 Identification

- 13.8.1 Descriptive labels shall be provided for all cabinets, enclosures, panels, assemblies and sub-assemblies.
- 13.8.2 Labels shall be of engraved type, with durable markings and shall have character size not less than 6 mm high.
- 13.8.3 The details of the labels including the material and size of the characters and sample of the labels shall be submitted to the Engineer for review.
- 13.8.4 Labels and notices on equipment shall be fixed with roundhead brass screws or self-tapping screws. Stick-on labels or fixing by adhesive shall not be accepted.
- 13.8.5 All enclosures containing terminals or exposed live parts where a voltage exceeds 120 volts shall have a label with lettering indicating the maximum voltage present in the enclosure.
- 13.8.6 Warning signs shall be provided with graphical symbols and wordings in red for hazardous electrical or optical laser equipment.

13.9 Marshalling and Termination

13.9.1 General

- 13.9.1.1 Main distribution frames, digital distribution frames and optical distribution frames shall be provided at appropriate locations for signal termination, distribution, disconnection, diversion and in-circuit testing. Intermediate termination points shall also be provided as appropriate to allow cable network flexibility.
- 13.9.1.2 The signal termination and distribution practice shall adopt a consistent approach for easy circuit identification and is subject to the review of the Engineer.
- 13.9.1.3 The circuit terminations shall be secure enough to withstand vibration level, which is likely to be experienced in the railway environment. These terminations shall be designed to allow repeated circuit termination and disconnection.
- 13.9.1.4 Jelly Filled Telecom Quad Cable and PIJF Telephone Cables shall be terminated on Disconnection Type Terminal Blocks complying with IEC 60947-7-1. These Terminal Blocks shall be made of Polyamide 6.6 Insulating Material and shall use non-corrosive Metal Parts. These Terminal Blocks shall have provision for identification/number for each termination and shall be securely attached to Mounting Rails.
- 13.9.1.5 Wherever possible, standard multi-pin plug/socket shall be used to terminate multi-core cables for connecting to the equipment. Heat-shrinkable sleeves shall enclose all exposed and terminated contacts inside multi-pin connectors.
- 13.9.1.6 All RF Joints outside the cabinets shall be sealed by waterproof tapes or jackets.

13.9.2 Main Distribution Frame

- 13.9.2.1 Main distribution frame with 20% extra capacity for future expansion shall be provided at Telecommunication Equipment Room for the signal distribution of all voice, analogue, alarm and control circuits.
- 13.9.2.2 The Contractor shall provide at least five sets of the following accessories at each location where the main distribution frame is installed:
- tools for circuits connection and disconnection
 - plug-in devices for circuit disconnection
 - test cords and loop-back cords
 - signal patch cords
- 13.9.2.3 The outgoing circuits connecting to external lines and all circuits affected by lightning or high induced voltage shall be provided with lightning arrestors and surge protection devices with the required earth connections. For details of Transient Protection refer to Para 13.12 of this Particular Specifications.
- 13.9.2.4 All voice, analogue, alarm and control circuits including spares shall be properly terminated at the main distribution frame.

- 13.9.2.5 The main distribution frame shall be divided into different zones for different types of circuits.
- 13.9.2.6 The main distribution frame shall be equipped with copper earth bar to which all cable shields shall be connected. The copper earth bar shall be connected to the earth.
- 13.9.2.7 The main distribution frame shall be equipped with facilities such as use of different colours or markers to aid circuit pairs identification.
- 13.9.2.8 The Contractor shall maintain records of all the circuit terminations.
- 13.9.3 **Digital Distribution Frame**
- 13.9.3.1 Digital distribution frame shall be provided at Telecommunication Optical Room and at other locations as appropriate for data circuit termination.
- 13.9.3.2 The Contractor shall provide at least five sets of the following accessories at each location where the digital distribution frame is installed:
- plug-in devices for circuit disconnection
 - test cords and loop-back cords
 - signal patch cords.
- 13.9.3.3 Different modules in the digital distribution frame shall be provided for different types of data circuits.
- 13.9.3.4 The digital distribution frame shall be equipped with sufficient capacity for data circuits including spare circuits. The digital distribution frame shall also be equipped with an extra of 20% of termination capacity for future use.
- 13.9.3.5 Markers or labels shall be included in the digital distribution frame for easy identification of the circuits.
- 13.9.4 **Optical Distribution Frame**
- 13.9.4.1 Optical Distribution Frame shall be provided at Telecommunication Equipment Room, and at other locations as appropriate for optical signal distribution and spare fibres cores storage.
- 13.9.4.2 Optical Distribution Frame shall comprise of equipment cabinet(s) or enclosures housing,
- fibre splice module
 - fibre storage panel
 - optical patch panel
- 13.9.4.3 All fibre cores terminating in the optical distribution frame shall be spliced to factory manufactured pigtails or properly stored in the fibre storage panel.
- 13.9.4.4 Optical patch cords shall be provided to connect the optical terminal to the optical distribution frame and for patching within and between optical patch panels.
- 13.9.4.5 Fibre storage panels shall be provided in the optical distribution frame to stow the excess length of pigtail and patch cords.
- 13.9.4.6 All splices shall be fusion splices and heat shrink splice sleeves shall be used for splice protection and housed in a fibre splice module.
- 13.9.4.7 All fibre splice modules shall be either telescopic or hinged type for easy access of splice elements.
- 13.9.4.8 All fibre splice modules shall be equipped with built-in fibre slack take-up mechanism.
- 13.9.4.9 All optical distribution panels shall be either telescopic or hinged type for easy access of rear side of panels. The optical distribution panel shall be fully equipped with adapters for optical signal termination.
- 13.9.4.10 All spare adapters shall be protected with jackets.
- 13.9.4.11 One high quality optical connector such as LC/FC/PC single mode (SM) 10/125µm type shall be standardised. Optical connector type specified on the transmission equipment

shall be compatible with the optic fibre termination. The coupling loss of the connector shall be below 0.2dB.

- 13.9.4.12 All optical connectors shall comply with the ITU-T Recommendation G.652.
- 13.9.4.13 All pigtails and patch cords shall be properly labelled.
- 13.9.4.14 The optical distribution frame shall be equipped with sufficient capacity for all optical signal distribution and fibre storage. An extra of 20% capacity in each module shall be provided for future expansion.
- 13.9.4.15 All optical fibre splice configuration at each location shall be designed to fulfil the System fault tolerant requirement.

13.10 Power Supply Distribution

- 13.10.1 Electric Power Supply for Telecommunication Equipment & Telecom Power Supply Equipment is drawn from Main AC Distribution Boards as covered in Particular Specification for Signalling Works.
- 13.10.2 This 230 V AC Telecom Power Supply from Main AC Distribution Boards shall be taken to Telecommunication AC Distribution Board, from where it shall be distributed to all Telecom Equipment/Telecom Power Supply Equipment operating on 230 V AC. Telecom AC Distribution Board are equipped with MCBs of adequate capacity at Inputs and Outputs.
- 13.10.3 48 Volt DC Power Supply from 48 V DC Battery Backup System shall be taken to Telecom DC Distribution Board, from where it is distributed to all Telecommunication Equipment operating on 48 V DC. Telecom DC Distribution Board are equipped with MCBs of adequate capacity at Inputs and Outputs.

13.11 Earthing Policy

13.11.1 General

- 13.11.1.1 Earthing shall be provided for all indoor & outdoor Telecommunication installations to achieve the following objectives:
 - to provide safety to the operating & maintenance personnel against the electric shock on account of any potential (voltage) appearing on exposed parts with respect to earth or due to electromagnetic or due to electrostatic induction;
 - to ensure safe & reliable operation of the equipment by limiting or eliminating the induced voltages and transients in the Telecommunication equipment;
 - to protect the equipment against build-up of unduly high voltages, which can cause dielectric (Insulation) breakdown or damage to the equipment or their parts;
 - to serve as common voltage reference point wherever required.
- 13.11.1.2 An earthing system shall be designed to assure personnel safety and protection of installations against damage. It shall also serve as a common voltage reference and to contribute to the mitigation of disturbances.
- 13.11.1.3 To achieve the primary goal of assuring personnel safety and damage control, a low impedance path shall be made available to the current generated due to lightning or power system fault. The potential differences between any two points shall be as low as possible. Safety considerations also require the chassis or enclosure to be earthed to minimise shock hazards to system staff.
- 13.11.1.4 To achieve the secondary goal of providing protection for sensitive and interconnected electronic and electrical systems, earthing shall be designed to minimise the noise voltage generated by currents from two or more circuits flowing through common earth impedance and to avoid creating earth loops susceptible to magnetic fields and differences in earth potential.
- 13.11.1.5 Earthing and other protective measures in the following paragraphs are given only as indicative guidelines. The Contractor shall design, manufacture, install and be responsible for safe and correct working of all equipment/Subsystems under the scope of the Contract.

- 13.11.1.6 The Contractor shall submit, for review and approval the design for earthing, transient protection and lightning protection of all Telecommunication Subsystems including earthing and lightning protection of the radio tower and trains. OEM's original data sheets of the proposed devices shall also be submitted.
- 13.11.2 **Requirements of effective Earthing**
- 13.11.2.1 The Earthing system shall meet or exceed the requirements of IEC 62305, IEC 62561, IEC 60634, and ITU-T Recommendation K.27 or relevant International Standards.
- 13.11.2.2 Earthing and other protection devices shall be designed to accomplish the following minimum requirements but not limited to:
- protect personnel and equipment from electrical hazards, including lightning and reduce fire hazards;
 - reduce potential to system neutrals;
 - enable signalling with earth return;
 - reduce or eliminate the effects of electrostatic and electromagnetic interference arising from within the EDFC on account of traction voltages, traction return current, electric locomotive characteristics and other extraneous sources;
 - minimise service interruptions and equipment damage:
 - minimise radiated and conducted electromagnetic emissions:
 - reduce radiated and conducted electromagnetic susceptibility:
 - improve system tolerance to discharge of electrostatic energy and lightning interference:
 - provide a proper earthing method for all equipment enclosures, cabinets, drawers, assemblies and sub-assemblies; and
 - provide a clean zero-volt reference point where required.
- 13.11.2.3 The earthing system shall be so designed as to give earth resistance within the stipulated limits at all locations and under all climatic conditions.
- 13.11.2.4 Any electrical joints in the earthing system shall be protected from moisture ingress by using proper wrapping, sealing with waterproof tapes, or such other measures.
- 13.11.2.5 For the purpose of measurement of earth resistance, a small interconnecting copper strip of appropriate cross-section shall be provided in the ring earth in a small manhole chamber so that the ring earth can be broken from the loop.
- 13.11.2.6 The earthing methods, design and details shall be submitted to the Engineer for review and approval.
- 13.11.3 **Earthing of Indoor Equipment**
- 13.11.3.1 Main earth bus bar shall be provided in the power supply room by the Contractor. The Contractor shall provide minimum 16 mm² cable from the power supply room to the TER and terminate on copper earthing strips of sufficient size and specifications. These earthing strips shall be used by the Contractor to extend individual earths to cables and racks/equipment etc.
- 13.11.3.2 In order to ensure a captive earth connection to the cabinets and racks in TER, a minimum cross-section of 16 mm² copper wire shall be used for earthing.
- 13.11.3.3 The cabinets within a row are to be conductively connected by means of screws and contact washers. Two or more rows are interconnected via the earth bus and if necessary, also by additional earthing cables. In case that one of the cabinets/racks is removed, it shall be ensured that the other cabinets in the row remain earthed
- 13.11.4 **Earthing of Outdoor Installations**
- 13.11.4.1 Outdoor installation, listed below, shall be earthed to the nearest Main earth bus bar with a minimum 16 mm² copper conductor:
- metallic sheath and armouring of all cables at regular intervals;
 - location boxes;
 - racks;
 - video cameras

- clocks display units; and
 - any other Telecommunication installation as may be necessary to cover complete scope of works defined in the Contract.
- 13.11.4.2 The Contractor shall also use suitable safety methods such as screen of wire mesh (earthed) for safety of maintenance staff wherever there is infringement of equipment installation in the signal clearance zone as per Indian Railway's Railway Electrification practices.
- 13.11.5 **Earthing Arrangement**
- 13.11.5.1 The Contractor shall provide two separate earth connections, a clean earth connection to the earth terminals provided inside the rooms where the Telecommunication equipment is installed, and a main earth connection for the earthing of radio towers, antenna feeder cables, equipment chassis, etc. of the Telecommunication System.
- 13.11.5.2 The earthing system shall meet, but not be limited to, the following:
- The resistance to earth of the system "earth terminal" shall remain within the stipulated limits at all locations and under all climatic conditions.
 - Any electrical joints in the earthing system shall be protected from moisture ingress by using proper wrapping, sealing with waterproof tapes, or such other measures.
- 13.11.5.3 The earthing arrangements for Antenna Towers and Antennae shall be such that:
- The zone of coverage shall afford protection of all objects forming part of the Antenna Towers and Antennae including any objects near the base of the tower, and this factor shall be taken into consideration while deciding the height of the lightning conductor at the top of the tower.
 - Earthing of VHF/UHF Antenna Feeder Cables having Copper Sheaths shall be such as to maintain a low resistance connection to the earth. Any junction forming a part of this connection shall be protected from ingress of moisture by using proper wrapping, sealing with water-proof tapes, or such other measures. The connection shall be inspected periodically at intervals frequent enough to ensure that the earth connection meets all the requirements. Earthing kits of approved type shall be used for this purpose.
- 13.11.5.4 The earthing arrangements for Telecommunication Equipment shall be as below:
- All Telecommunication equipment shall be protected using a mesh of copper "earth" strips of appropriate cross-sectional dimensions, forming a local clean earth bus.
 - Each equipment rack shall be connected electrically to this bus. This bus shall be connected to the external ring earth at the shortest possible distance from two opposite points of this bus.
 - All joints of this connection shall be protected from ingress of moisture by using proper wrapping, sealing with water-proof tapes, or such other measures.
 - The earthing connection shall be inspected periodically at intervals frequent enough to ensure that the earth connection meets all the requirements.
- 13.11.5.5 The metallic sheath and armouring of all cables (RF Cables/Optical Fibre Cable/Others) shall require earthing. In the section earthing shall be done as per the established practices in RE areas of the Indian Railways.
- 13.11.5.6 The earthing electrodes for the clean earth shall be located at least 20 m away from the main earth.
- 13.11.5.7 The route for the clean earth shall be so chosen as to minimise the effect of any inductive interference.
- 13.11.5.8 For the purpose of measurement of earth resistance, a small interconnecting copper strip of appropriate cross-section shall be provided in the ring earth in a small manhole chamber so that the ring earth can be broken from the loop.

- 13.11.5.9 The earth resistance at any point on the clean earth shall be below 0.5 Ohm, and that for the main earth shall not exceed 1.0 Ohm at any location and under any soil and/or climatic condition.
- 13.11.5.10 All metal work and metallic items shall be earthed to the main earth to ensure the safety of personnel.
- 13.11.5.11 The earthing methods and details shall be submitted to the Engineer for review.
- 13.11.5.12 Radio equipment shall be provided with isolated terminations for the connection of coaxial cables extending to equipment in external locations.

13.12 Transient and Lightning Protection

- 13.12.1 An effective transient protection system, complying to the following as a minimum must be provided to protect the telecommunication equipment from transients:
- (1) Peak transients of up to 700 Volts on the DC Power Supply line for several microseconds.
 - (2) Average transient duration of 2 microseconds with a repetition frequency of 15kHz to 100kHz
 - (3) For short duration transients (<5ms) the variation approaches a sine wave
 - (4) For longer duration transients (>5ms) the variation approaches rectangular pulses with an initial rate of rise up to 5×10^4 Volts per second.
- 13.12.2 Suitable electronic devices (such as silicon avalanche suppressor devices/transzorbs) having high surge handling capability, fast response time and low clamping voltage, etc; shall be incorporated in the telecommunication equipment to ensure that the latter withstands the above mentioned conditions without any damage or permanent degradation in performance throughout the system lifetime. The selection criteria for such devices shall include, but not be limited to, the following:
- (1) reverse standoff voltage shall be atleast twice the maximum operating voltage;
 - (2) pulse power rating shall be adequate to handle the peak pulse power of the transients and ensure their decay in less than 10% of the rise time for the worst pulse likely to be encountered from all possible sources including lightning and transients from overhead traction power system;
 - (3) Device lifetime shall not be less than that of the system for which it affords protection.
- 13.12.3 Surge protection devices shall be provided at TER end and outdoor equipment end, on power and data cables extending to outdoor telecommunication equipment installations as a minimum as defined below:
- (1) clock displays surge protection devices at both ends;
 - (2) video cameras surge protection devices at both ends;
 - (3) radio frequency feeder cables separately for each individual cable of VHF antenna & GPS antenna on both ends;
 - (4) armour of optical fibre cable shall be directly earthed at TER end and earthed through a surge protection device at the other end station;

13.13 Lightning Protection

- 13.13.1 While the station buildings will be provided with the lightning protection arrangements, the protection against lightning surges travelling through conductors into equipment shall be provided by Contractor using appropriate devices.
- 13.13.2 The Contractor shall submit the proposed measures for review by the Engineer.

13.14 Housing, Enclosure and Cabinet

- 13.14.1 All equipment installed shall be able to withstand vibration levels likely to be experienced in railway stations and along railway track side structures.
- 13.14.2 All design of housing and enclosure shall be submitted to the Engineer for review.

- 13.14.3 Unless specified otherwise, all equipment to be housed in outdoor environment (open areas, etc) shall be with IP 65 enclosures as a minimum.

*** End of Chapter 13 ***

CHAPTER 14 - TESTING AND COMMISSIONING

14.1 General

- 14.1.1 The Contractor shall perform stage-wise testing and commissioning activities in accordance with the requirements given in this Specification.
- 14.1.2 The Contractor shall ensure that prior to the commencement of tests; documentation associated with tests has been reviewed without objection by the Engineer.
- 14.1.3 The Contractor shall ensure that the equipment/Subsystem/System is in a state ready for testing and commissioning before the commencement of the tests. The Contractor shall conduct trial tests and satisfy himself before offering the equipment/Subsystem/System for the tests. Test results of the Contractor's own trial tests shall be made available to the Engineer on request. This is to indicate the readiness of the equipment/Subsystem/System for tests.
- 14.1.4 The Contractor shall provide all necessary test instruments, special tools, emulators, simulators and test software to carry out the tests.
- 14.1.5 The Contractor shall satisfy himself that all items interfacing to Project Contractors are in satisfactory condition for the Contractor's tests to be carried out. The Contractor shall provide simulation for testing in case the interfacing equipment is not available for testing.
- 14.1.6 The Contractor shall extend full support to the Engineer and provide all necessary facilities to enable convenient inspection of materials, work and testing.
- 14.1.7 The Contractor shall investigate and provide corrective actions for all the faults detected during the tests. The tests shall be resumed only after all the faults are properly cleared. The Contractor shall submit fault report to the Engineer to describe the symptom and causes of the faults and the corrective actions taken.
- 14.1.8 If the operation of other Project Contractor's system or equipment is suspected to be affected by the system during the test, the Contractor shall withhold the test, investigate and take corrective actions, if necessary, before resumption. The test shall be resumed only after the interference has been eliminated or found not to be related to the System.

14.2 Testing Stages

- 14.2.1 The Contractor shall carry out testing and commissioning activities in the following phases:
- (1) Factory Acceptance Tests;
 - (2) Installation Tests;
 - (3) System Acceptance Tests; and
 - (4) Integrated Testing and Commissioning.
 - (5) Service Trial.

14.3 Factory Acceptance Tests

- 14.3.1 The Contractor shall prepare and submit, at least six months before the tests, for review by the Engineer the Factory Acceptance Test Plan, detailing and explaining how the contractor shall plan, perform, and document all inspections and tests that shall be conducted to verify and validate the works prior to delivery to Site. In addition, the Factory Test Plan shall also include the following:
- (1) a list of equipment and cables for individual Subsystems to have Factory Acceptance Test;
 - (2) the program of all the activities related to factory acceptance tests;
 - (3) the locations where factory acceptance tests to be carried out;
 - (4) the estimated duration of tests activities at each location; and
 - (5) submission schedule of all the factory acceptance test procedures for equipment and cable.
- 14.3.2 Factory Acceptance Test shall be carried out for equipment and cables of all the Subsystems.

- 14.3.3 The Contractor shall carry out factory acceptance tests at the place of manufacturing. The test shall include, but not be limited to, visual inspection, environmental tests, electrical tests, functional tests and fatigue tests on each individual equipment and associated Subsystem as well as cables before delivery of the equipment to the Site.
- 14.3.4 The environmental tests and fatigue tests are not required; if it has already been conducted and independently witnessed previously on similar item and test results are accepted by the Engineer.
- 14.3.5 The Contractor shall prepare the Factory Acceptance Test Procedures for equipment and cables and submit to the Engineer for review. The Factory Acceptance Test Procedures shall describe in detail all tests to be performed on the equipment and cables along with pass/fail criteria (i.e. the standards or limit to be achieved).
- 14.3.6 The Factory Acceptance Test shall not be started unless the Factory Acceptance Test Procedures have been reviewed without objection by the Engineer.
- 14.3.7 Factory Acceptance Tests shall be witnessed by the Engineer, however on all major equipment items or Subsystems identified during Detailed Design Stage factory acceptance tests shall be witnessed jointly by the Employer's Personnel and the Engineer.
- 14.3.8 Factory Acceptance Tests for all items procured against IRS/RDSO Specifications and being procured from RDSO approved sources shall be witnessed by RDSO. Inspection Charges to be paid to RDSO for these Factory Acceptance Tests shall be borne by Contractor. Where any part of testing is carried out by an independent laboratory, a copy of Test Certificate issued by the relevant authority of that laboratory shall be submitted along with the Factory Acceptance Test Procedure.
- 14.3.9 The Factory Acceptance Tests are considered completed only if the Engineer without objection reviews the Factory Acceptance Test results.

14.4 Installation Tests

- 14.4.1 Installation Tests shall be carried out on individual Subsystem location by location after the completion of equipment physical installation.
- 14.4.2 The objective of the installation tests shall be to ensure the following:
- (1) the equipment is installed in accordance with the reviewed design documentation
 - (2) the equipment is installed in accordance with the requirements detailed in this Specification
 - (3) all cables are properly and accurately connected and terminated
 - (4) all installation works are of acceptable workmanship
- 14.4.3 The Contractor shall develop procedures for Installation Tests and submit to the Engineer for review. The installation test procedures shall describe in detail all tests to be performed on the equipment and cables along with pass/fail criteria (i.e. the standards or limit to be achieved).
- 14.4.4 The Installation Test shall not be started unless the installation test procedures have been reviewed without objection by the Engineer.
- 14.4.5 All installed equipment and cables shall be physically inspected against all relevant reviewed design documentation.
- 14.4.6 The Contractor shall measure the end-to-end performance of all cores of the copper cables and optical fibre cables, including all spare cores, laid between different locations.
- 14.4.7 The Contractor shall verify all the connections within the antenna network and measure the attenuation and VSWR values of all the connections.
- 14.4.8 All the installation test results, physical locations of the equipment and serial numbers shall be captured in the test record forms. The Contractor shall include completed test record forms in the Test Report and submit to the Engineer for review.
- 14.4.9 The Installation Tests are considered completed only if the Engineer without objection reviews the Installation Test results.

14.5 System Acceptance Tests

- 14.5.1 The Contractor shall carry out System Acceptance Tests after the completion of the Installation Test.
- 14.5.2 System Acceptance Tests shall be carried out on individual Subsystem as well as whole System to verify the functional, operational performance, electrical performance and services coverage at the stage:
- (1) after successful completion of the Installation Tests;
 - (2) after the Subsystems have been configured with correct settings and parameters;
 - (3) properly connected to the power supply and can be switched on for System Acceptance Tests; and
 - (4) before the equipment of different locations are ready for Integrated Testing & Commissioning.
- 14.5.3 The Contractor shall develop System Acceptance Tests procedures for each Subsystem and System as a whole and submit to the Engineer for review.
- 14.5.4 The System Acceptance Tests procedures shall include:
- (1) objectives of the System Acceptance Tests for all subsystems;
 - (2) objectives of the System Acceptance Tests for system as a whole;
 - (3) list of specifications and standards, reviewed design documentation for reference;
 - (4) step-by-step test instructions;
 - (5) list of test instrument and special tools;
 - (6) test record forms; and
 - (7) pass or fail criteria.
- 14.5.5 Where performance across interfaces to other System within this Contract is required to be verified during the System Acceptance Tests, the Contractor shall include a list of other systems and the interface test procedures in the System Acceptance Tests procedures for the relevant Subsystem.
- 14.5.6 Where performance across interfaces to Project Contractors or to other parties is required to be verified during the System Acceptance Tests, the Contractor shall include a list of Project Contractors and the interface test procedures agreed with the relevant Project Contractors in the System Acceptance Tests procedures for the relevant Subsystem.
- 14.5.7 The functional, electrical and timing performances of the Subsystems as well as System as a whole shall be verified against the requirements and relevant international standards.
- 14.5.8 The Contractor shall conduct end-to-end circuit test to verify the circuit integrity and electrical performance for all circuits including spare.
- 14.5.9 All local alarms, control and monitoring functions shall be verified.
- 14.5.10 All equipment settings and parameters shall be verified and recorded in the reviewed test record forms.
- 14.5.11 Coverage test shall be carried out on location basis for the Radio system.
- 14.5.12 All protection mechanisms such as hot-standby, parallel redundancy, automatic switchover, etc., built into the system and individual Subsystems shall be verified.
- 14.5.13 The system response time of relevant Subsystems and the System shall be tested and measured.
- 14.5.14 The Contractor shall carry out load test on each Subsystem to verify the designed system capacity and performance in accordance with the requirements given in the Particular Specification under full load condition.
- 14.5.15 The Contractor shall carry out tests on the operation of the System in accordance with the normal operation procedures and emergency operation procedures, which has been reviewed without objection by the Engineer.
- 14.5.16 The System Acceptance Tests are considered completed only if the Engineer without objection reviews the System Acceptance Test results.
- 14.5.17 Upon completion of the System Acceptance Test, the individual Subsystem shall be operational and ready to be connected to other Subsystems and interfacing systems for testing.

14.6 Integrated Testing and Commissioning

- 14.6.1 The Contractor shall carry out Integrated Testing and Commissioning after the completion of the System Acceptance Tests.
- 14.6.2 The Contractor shall co-ordinate with the Engineer and with all the interfacing Project Contractors/Parties to ensure all the interface test activities are completed in accordance with the program on Completion Plan.
- 14.6.3 The Contractor shall provide all necessary supports, conduct investigation and provide corrective actions, if necessary, to ensure all matters related to interfacing are properly resolved.
- 14.6.4 Within one week upon completion of all interface test activities, the Contractor shall submit the test results to the Engineer for review.
- 14.6.5 After the test results of all interface test activities have been reviewed by the Engineer without objection, the Contractor shall start the Reliability Demonstration Test in accordance with the reviewed Reliability Demonstration Test Plan.
- 14.6.6 The Contractor shall advise the Engineer in writing the commencement date of the Reliability Demonstration Test.
- 14.6.7 The Contractor shall submit a Reliability Demonstration Test Plan to the Engineer for review at least three months before the test.
- 14.6.8 The Contractor shall include the following in the Reliability Demonstration Test Plan as a minimum:
- (1) calculation of the maximum allowable number of failures of equipment, Subsystems and System during the reliability demonstration period in accordance with requirements on reliability performance of the equipment, Subsystems and System given in the Particular Specification
 - (2) definition of relevant failures
 - (3) pass and fail criteria
 - (4) sample of fault logs
- 14.6.9 During the reliability demonstration test period, the Contractor shall record details of all faults in a fault log which shall include:
- (1) the date and time the fault occurs
 - (2) the date and time the Contractor's staff arrive on site
 - (3) the date and time the fault is cleared and the normal operation is restored
 - (4) the description of the fault
 - (5) the cause of the fault
 - (6) equipment or component replaced
- 14.6.10 All fault logs shall be submitted to the Engineer for review.
- 14.6.11 The reliability demonstration test is considered a failure if:
- (1) the actual number of relevant failures exceeds the maximum allowable number of failures for any equipment, Subsystems or System identified in the Reliability Demonstration Test Plan
 - (2) any fault resulting from the Design omission or commission of error requires Design modification in order to fix the fault
- 14.6.12 If the reliability demonstration test fails, the Contractor shall provide all the necessary corrective actions and rectify the fault to the satisfaction of the Engineer.
- 14.6.13 The reliability demonstration test shall be repeated on the affected Subsystem or Subsystems for another three months until the test is successfully completed.
- 14.6.14 Within two weeks upon completion of the Reliability Demonstration Test, the Contractor shall submit the test results for the Engineer to review.
- 14.6.15 The Integrated Testing and Commissioning is considered completed only if all the test results of the Integrated Testing and Commissioning have been reviewed by the Engineer without objection.

14.7 Service Trials

- 14.7.1 The Contractor shall provide all necessary support and attendance to the Engineer during the Service Trials period.
- 14.7.2 The Contractor shall provide on-Site supports to the Engineer in all aspects related to the operation of the System. The Contractor shall also conduct investigation and provide corrective actions for any problems related to the System or the interfaces with the System.
- 14.7.3 The Contractor shall assign competent staff to support the Service Trials as required by the Engineer. The persons shall be the technical staff who shall have sufficient skills and knowledge of the System and shall have been involved in the Design, installation or commissioning of the System.
- 14.7.4 The Contractor shall submit a Manpower Plan to the Engineer for review at least 1 month before the commencement of the Service Trials.
- 14.7.5 The manpower plan shall include the organisation chart of the Contractor's Service Trials supporting group, individual person's role and responsibility and 24-hour contacts for emergency cases.

*** End of Chapter 14 ***

CHAPTER 15 - SPARES, SPECIAL TOOLS AND TEST EQUIPMENT

15.1 Spares

The Contractor shall provide his own spares during Installation & Commissioning Period as well as during the Defects Notification Period. The Contractor shall also provide separate spares for the Employer to enable the Employer to operate and maintain the System.

15.1.1 Contractor's Own Spares

15.1.1.1 The Contractor shall keep and maintain sufficient stock of his own Installation & Commissioning Spares and Defects Liability Spares. In addition, in determining the list of spare parts for the Installation & Commissioning Spares and Defects Liability Spares, the Contractor shall provide calculation to support the proposed spares and quantities with the following taken into account:

- (1) the expected failure rate of the parts;
- (2) population of the parts in the System;
- (3) criticality of the parts in the System;
- (4) availability figures of the System;
- (5) spare delivery lead time; and
- (6) workshop repair turnaround time.

15.1.1.2 The Contractor shall submit the list of Installation & Commissioning Spares, with the types and quantities of spares, the Contractor intends to hold, at least three months before the commencement of installation activity to the Engineer for review.

15.1.1.3 The Contractor shall submit the list of Defects Liability Spares, with the types and quantities of spares, the Contractor intends to hold, at least six months before the commencement of the Defects Notification Period to the Engineer for review.

15.1.1.4 The Contractor shall include details of the stock of the Contractor's own spares in the Monthly Progress Report. The status of the spares, either in store or under workshop repair, shall also be included.

15.1.2 Contract Spares for Employer's Operational and Maintenance Requirements

15.1.2.1 The Contract Spares, to be supplied by Contractor to Employer for Employer's Operational and Maintenance Requirements, shall include spare modules, sub-assemblies, special components, cables, connectors, fuses etc. The Contract Spares to be supplied shall be as per the following list.

SN	Item	Total Quantity
1	SDH Node complete with all tributary cards and full hardware redundancy	1 of each type
2	2 Mb Mux complete with all channel cards and full hardware redundancy	1 of each type
3	All type of PCB cards including mother board ,Optical line termination Card,E1 Tributary card and power supply card for STM- Mux	10% of the total population for each type
4	All type of PCB cards including mother board, 2MB card ,VF card, E&M Card ,Data card and power supply card for 2 MB Mux	10% of the total population for each type
5	Notebook computer loaded with OFC NMS software	2
6	Layer-3 Switch	10% of the total population for each type
7	Layer-2 Switch	10% of the total population for each type

SN	Item	Total Quantity
8	Direct Line Console Complete for SCR	1
9	PBX Subscriber Line Cards	10% of the total population for each type
10	PBX Junction Line Cards	10% of the total population for each type
11	PBX Switch Cards	10% of the total population for each type
12	PBX System Control Cards and Power Supply Card	10% of the total population for each type
13	Digital Telephone Instruments	10% of the total population for each type
14	Analogue Telephone Instruments	10% of the total population for each type
15	Media Gateway	10% of the total population for each type
16	Direct Line Telephone Instruments other than Direct Line Console	10% of the total population for each type
17	All type of replaceable/plug-in modules for Voice Recording System	10% of the total population for each type
18	Control Office Equipment of Control Communication Equipment	1 of each type.
19	Way-Station Equipment of Control Communication Equipment	10% of the total population for each type
20	Notebook Computer loaded with PBX NMS Software	1
21	Base Transceiver Station(BTS)	1
22	All type of Replaceable/Plug-In Modules for BTS	10% of the total population for each type
23	All type of Replaceable/Plug-In Cards/Modules for BSC and TRAU	10% of the total population for each type
24	All type of Replaceable/Plug-In Cards/Modules for OMC	1 Card of each type.
25	Radio Dispatcher Console with associated hardware/accessories	1
26	Antennae for BTS	2
27	Replaceable/Plug-In Cards for Master Clock	1 Card of each type
28	Station Sub-Master Clock Complete	10% of the total population for each type
29	Digital Clock Units	10% of the total population for each type
30	Analogue Clocks	10% of the total population for each type
31	25 Watt VHF Transceivers along with Antennae, Associated Voice Recording Equipment and other associated Hardware/Accessories.	1

SN	Item	Total Quantity
32	SMPS Based Float Cum Boost Charger (48 V DC)	1
33	All type of Replaceable/Plug-In Cards/Modules for SMPS Based Float Cum Boost Charger	10% of the total population for each type
34	Maintenance Free Batteries	10% of the total population for each type
35	Fuses of all types	10% of the total population for each type
36	Terminals of all types	10% of the total population for each type
37	Transient/Surge Protection Device	10% of the total population for each type
38	Optical Distribution Frame	10% of the total population for each type
39	Telephone Cable Termination frame	10% of the total population for each type
40	Copper Cable Jointing Kits for all sizes of cables	10% of the total population for each type
41	Splicing Kits for OFC	10% of the total population for each type
42	Optical Fibre Cable	1 km for each type
43	Optical Fibre Splice Box & remake loops	10% of the total population for each type.
44	Optical Pigtail Cables	10% of the total population for each type.
45	Outdoor Telephone Cable	10% of the total population (km) for each type.
46	Indoor Telephone Cable	10% of the total population (km) for each type.
47	6 QUAD CABLE	10% of the total population (km) for each type.
48	All type of Connectors/Dummy Loads	10% of the total population for each type.
49	Emergency Socket	10% of the total population for each type.
50	Portable Emergency Telephone Set	4 Nos.

NOTE: The Quantity shall be rounded to nearest decimal natural number with minimum 1(one).

- 15.1.2.2 The Contractor shall submit list the of Contract Spares along with quantities at least 6 months before start of 'Defects Notification Period', based on approved tentative BOQ which shall be adjusted on approval of As-Built BOQ.
- 15.1.2.3 The list of Contract Spares shall include information such as brand name, model number, serial number (if applicable), rating(if applicable), description, part number(if applicable), drawing number, shelf life, bar-coded (as directed by the Employer) etc. of each item of Contract Spares.
- 15.1.2.4 The Contractor shall indicate the sources of supply of each item of Contract Spares and shall guarantee their availability during the service life of the system.

15.1.2.5 All Contract Spares shall be tested as per reviewed factory acceptance testing procedures before delivery to the Employer. The delivery to the Employer shall be completed by the start of 'Defects Notification Period'.

15.1.2.6 Any item not included as Contract Spare and subsequently found to be necessary during Defects Notification Period, shall be supplied by the Contractor in required quantities as variation to Contract under direction of Engineer.

15.2 Special Tools and Test Equipment

15.2.1 The Contractor shall provide his own test equipment and tools during the Installation & Commissioning Periods and Defects Notification Period.

15.2.2 The following Special Tools & Test Equipment shall be suitably packed and supplied to the Employer.

SN	Item	Total Quantity	SN
1	E1 Analyser	Nos.	1
2	Auto fusion splicing machine complete.	Nos.	1
3	SDH Analyser	Nos.	1
4	OTDR mini	Nos.	1
5	OTDR main frames	Nos.	1
6	Optical fibre tool box Impairment (TIMS)	Nos.	1
7	Digital multi-meter	Nos.	2
8	Earth tester	Nos.	1
9	Megger 500 Volts	Nos.	1
10	Mega OHM meter	Nos.	1
11	Optical Power Source	Nos.	1
12	Optical Power Meter	Nos.	1
13	Optical Variable Attenuator	Nos.	1
14	Cable tool kit	Nos.	1
15	Hand Held RF Analyser	Nos.	2
16	Cable Route Locator	Nos.	1
17	Portable Generator 1.5 KVA	Nos.	1
18	Emergency light	Nos.	2
19	Cable & Antenna Analyser	Nos.	1
20	RF Power Sensors	Nos.	1
21	Vehicle Mountable Drive Test Equipment for GSM-R	-	1 (System)
22	General purpose telecom tool kit.	Nos.	2
23	Power supply (Variable) 0 to 60 Volt DC	Nos.	2
24	Vacuum Cleaner	Nos.	1

SN	Item	Total Quantity	SN
25	Maintenance Vehicle (Semi Utility Vehicle Type)	Nos.	1
26	Drilling machine with hammer action capable of working on wood, metal, concrete complete with chuck drill bits	Nos.	1
27.	VHF Power Meter with all accessories	Nos.	1
28	Fibre Microscope	Nos.	1

- 15.2.3 The Contractor shall submit the technical specifications, datasheets and operational manual of each type of Special Tool & Test Equipment at least six months before the start of Defects Notification Period to the Engineer for review.
- 15.2.4 All Special Tools & Test Equipment shall be supplied together with all cords and connectors, operation manuals, complete diagrams, schematics, assembly and connection drawings, maintenance instructions and calibration certificates.
- 15.2.5 None of the Special Tools & Test Equipment provided for the Employer shall be used on site prior to delivery to the Employer.
- 15.2.6 The supply of Special Tool & Test Equipment shall be completed by the start of Defect Notification Period.
- 15.2.7 All tools and test equipment required in the field for restoration of the network shall be suitably fixed in the maintenance vehicle (Mobile Telecommunication maintenance vehicle), so that in case of failures, the mobilisation time is minimised and complete equipment required for repair are carried by the maintenance vehicle.

***End of Chapter 15 ***

CHAPTER 16 – TRAINING

16.1 General

- 16.1.1 The Contractor shall provide comprehensive training to the Employer's Personnel in respect of design, system engineering, construction/installation, assembly, configuration, operations, fault diagnosis and maintenance of the systems/sub-systems, provided under the Contract. The Contractor shall arrange Training at manufacturing facilities as well as at site, as per the approved Training Plan.
- 16.1.2 The training at manufacturing facilities has the potential of imparting maximum benefit to the Employer's Personnel and shall cover all telecommunication equipment provided under the contract. All the training courses at manufacturing facilities shall be conducted during design period and completed before the commencement of installation.
- 16.1.3 The Contractor shall also arrange training at site for Employer's Maintenance and Operating Personnel. The Contractor shall set up training class rooms near to site, where he shall provide competent training instructors, training manuals, all necessary aids and materials as required for all the training courses. The training courses shall cover working principles, installation, operation, fault diagnosis & maintenance of all major equipment and works engineered by the Contractor. All the training courses at site shall be conducted during installation period and completed before the commencement of testing and commissioning.
- 16.1.4 The training instructors shall be qualified, competent, with sufficient years of practical experience in the relevant fields. The training instructors shall be either the system designer or engineering staff of the Contractor, the Contractor's subcontractors or the equipment manufacturers. No training instructor shall be deployed without prior approval of the Engineer. The training shall be in English and Hindi languages as required. The training abroad shall, however be in English language only. All training material shall be provided in English. If requested by the Engineer, the training material shall be provided in Hindi also.
- 16.1.5 The Contractor shall bear all the training costs except for allowances, hotel and travel expenses of the Employer's Personnel.
- 16.1.6 The Contractor shall provide full-time management, co-ordination and supervision of the entire training Program to ensure the continuity of classes and proper distribution of training materials and be responsible for interfacing with the instructors.

16.2 Training Plan

- 16.2.1 Within six months after the Commencement Date of the Works, the Contractor shall submit a Training Plan to the Engineer for review.
- 16.2.2 The Training Plan shall include, but not be limited to, the following:
- (1) the program of the training courses at site and at manufacturing facilities;
 - (2) overview and description of objectives of each training course;
 - (3) the location where the training courses to be conducted;
 - (4) submission schedule of the training materials;
 - (5) set ups for practical exercises;
 - (6) the Contractor's training organisation chart, including the role and responsibilities of individual key persons;
 - (7) the qualifications and experience of the training instructors;

16.3 Training Courses

- 16.3.1 Training at site shall be 50 instructor man-days which includes operation, maintenance and troubleshooting courses. The class will be of maximum of 30 trainees. The Contractor shall determine the number of classes for each type of training course to ensure the objectives of the course can be met.
- 16.3.2 **Operation Courses at site**
- 16.3.2.1 The operation training courses shall be developed to provide all necessary knowledge and skills for operations staff of the Employer for operating the system under normal and emergency situations and recovery from minor or simple faults. In particular, the training course shall include the following as minimum:
- (1) overview of the Telecommunications System;
 - (2) brief description of the operation principles of the Subsystems;
 - (3) operational features and functions;
 - (4) familiarisation and use of all man-machine interfaces involved;
 - (5) reading and interpretation of system status and alarm messages or indications;
 - (6) normal operating procedures;
 - (7) operating procedures under emergency situations;
 - (8) procedures for recovery from minor or simple faults; and
 - (9) use of Operation Manuals and documentation.
- 16.3.2.2 Particular exercises shall be included in the operations training course for each trainee to operate and manage the system under normal and emergency operating conditions and simple faults recovery.
- 16.3.3 **Maintenance & Troubleshooting Courses at site**
- The Maintenance & Troubleshooting courses shall be developed to provide all necessary knowledge and skills for maintenance staff of the Employer to perform full maintenance, including both preventive and corrective maintenance and fault diagnosis in case of failure.
- 16.3.3.1 In particular, the training course shall include the following as minimum:
- (1) overview of the Telecommunications System;
 - (2) brief description of the operation principles of the Subsystems;
 - (3) operational features and functions;
 - (4) description of system components and equipment down to card or module level;
 - (5) test and commissioning procedures;
 - (6) use of test equipment and special tools;
 - (7) preventive maintenance procedures;
 - (8) fault diagnosis, troubleshooting and corrective maintenance procedures;
 - (9) equipment settings and parameters configuration;
 - (10) use of equipment manuals, Operation and Maintenance manuals, circuit diagrams and wiring schematics;
 - (11) familiarisation and use of all man-machine interfaces involved;
 - (12) reading and interpretation of system status and alarm messages or indications;
 - (13) normal operating procedures;
 - (14) operating procedures under emergency situations;
 - (15) procedures for recovery from faults; and
 - (16) use of Maintenance Manuals and documentation.
- 16.3.3.2 Practical exercises shall be provided for each trainee to practise the following as minimum:
- (1) use of test equipment and special tools;
 - (2) preventive maintenance;
 - (3) fault diagnosis and troubleshooting with induced faults set by the Contractor to simulate real-life situation;
 - (4) faulty modules or cards replacement and restore the system to normal operation; and
 - (5) handling and transportation of cards.
- 16.3.4 **System Engineering Courses at manufacturing facilities**

- 16.3.4.1 Training at manufacturing facilities shall be for 60 man-days. The class will be of maximum 6 trainees.
- 16.3.4.2 The system engineering courses shall be developed to provide all necessary knowledge and skills to perform system engineering management including system parameter configuration, enhancement, expansion and provision of new circuits.
- 16.3.4.3 The Contractor shall determine the content of the courses and the courses shall include the following as minimum:
- (1) overview of the Telecommunications System;
 - (2) background theory;
 - (3) system features and functions;
 - (4) system configuration and operation principles;
 - (5) description of system components and equipment down to card or module level;
 - (6) test and commissioning procedures;
 - (7) use of test equipment and special tools;
 - (8) reading and interpretation of alarm indications, messages and print-outs;
 - (9) preventive maintenance procedures;
 - (10) fault diagnosis, troubleshooting and corrective maintenance procedures;
 - (11) equipment settings and parameters configuration;
 - (12) use of equipment manuals, Operation and Maintenance manuals, circuit diagrams and wiring schematics;
 - (13) methods and procedures to provide new circuits, system expansion and enhancement;
 - (14) data, software backup and loading; and
 - (15) use of software such as peripheral control and configuration, utility, database structure, generation and modification.

16.4 Training Materials

- 16.4.1 At least two months before the commencement of the training course, the Contractor shall submit all the training materials including the trainer's guides, training manual for trainees, training aids and presentation materials to the Engineer for review. The training materials shall be prepared in a form allow easy future reproduction.
- 16.4.2 The format of the trainer's guides and training manual for trainees shall be submitted to the Engineer for review.
- 16.4.3 The Contractor shall, for each course, distribute two sets of trainer's guides, one set of training manual for each trainee, two sets of trainer's guides and three additional sets of training manual to the Engineer before the commencement of the training course.
- 16.4.4 All the training materials shall be accurate and match with the actual Design of the System.

16.5 Training Records

- 16.5.1 The Contractor shall devise a system, standards in assessing the level of knowledge, understanding of the course content and proficiency of the trainees. The system and standards shall be submitted to the Engineer for review four weeks before the commencement of the training course.
- 16.5.2 The Contractor shall issue appropriate training certificate to the trainees who pass the assessment.

16.6 Course Evaluation

- 16.6.1 The Contractor shall develop questionnaires to trainees for each training course in determining the level of satisfaction with the course content. Appropriate scoring weighting shall be assigned to each question in the questionnaires such that the scores shall reflect the trainee's satisfaction to the training course. The questionnaires shall be submitted to the Engineer for review four weeks before the commencement of the training course.
- 16.6.2 Upon completion of each training course, the Contractor shall distribute the questionnaires to the trainees to fill in.

- 16.6.3 The Contractor shall submit a training report to the Engineer for review within two weeks after completion of each course. The training report shall include a summary of the training course conducted, the results of trainees' assessment and the course evaluation questionnaires.
- 16.6.4 The contractor shall submit the course evaluation criteria to the Engineer for approval.

End of Chapter-16

CHAPTER 17 –INTERFACE REQUIREMENTS

17.1 General

- 17.1.1 The Contractor shall co-ordinate its interface requirements with Employer and Other Interfacing Contractor(s), which Employer may engage from time to time, in such a manner so as to minimize disruption to any party arising from such concurrent work.
- 17.1.2 Co-ordination responsibilities of Contractor shall include, but not be limited to following:
- (1) Provision of all information reasonably required by the interfacing parties in a timely and professional manner so as to allow them to proceed with their design or construction activities and enable them to meet their contractual obligations.
 - (2) Assurance that the interfacing parties' requirements are provided to all concerned interfacing parties in time providing them ample opportunity to do their part of requirement for interfacing.
 - (3) Receipt from interfacing parties of such information as is reasonably required to enable Contractor to meet Design Submission Program as identified in General Specifications.
- 17.1.3 Assurance, copies of all the correspondence, drawings, minutes of meeting, programs, etc. relating to the Contractor's co-ordination with the Other Interfacing Contractor(s) shall be issued to all concerned parties and four (4) copies issued to the Engineer no later than seven (7) calendar days from the date of such correspondence and meetings.
- 17.1.4 The Contractor shall provide sufficient information for the Engineer to decide on any disagreement between Contractor and Other Interfacing Contractor(s) as to extent of services or information required to exchange. If such disagreement cannot be resolved by Contractor despite having taken all reasonable efforts, the decision of the Engineer shall be final and binding on the Contractor(s).
- 17.1.5 Where an interfacing contract is yet to be awarded, the Contractor shall proceed with co-ordination activities with Engineer until such time as Other Interfacing Contractor is appointed.
- 17.1.6 The Contractor shall note that information exchange is an iterative process requiring exchange and updating of information at earliest opportunity and shall be carried out on a regular and progressive basis so that the process is completed for each design stage by the respective dates.
- 17.1.7 Contractor shall liaison with designated authorities in Indian Railway to develop integrated design of Mobile Train Radio Communication System based on GSM-R System. Contractor shall further liaison with designated authorities in Indian Railway for Installation, Testing & Commissioning of this integrated GSM-R System.
- 17.1.8 Contractor shall liaison with designated authorities in Indian Railway to design Telecom Arrangement for/at boundaries with Indian Railways. The contractor shall execute the so approved Telecom Arrangement for/at boundaries with Indian Railways.
- 17.1.9 The Contractor shall co-ordinate with Engineer on all matters relating to works that may affect the IR operation on the existing railway. Such works shall be carried out in accordance with IR Rules and Regulations.

17.2 Interface Management

- 17.2.1 The Contractor shall be responsible for identifying all internal and external interfaces and shall develop and maintain a full interface management system which shall cover the functional and technical aspects of all the internal and external interfaces of the Contractor.
- 17.2.2 The Contractor shall develop Interface Management Plan as stipulated in General Specifications. This Interface Management Plan shall include all internal and external interfaces.
- 17.2.3 The Contractor shall undertake design co-ordination with Other Interfacing Contractor(s) and Indian Railways.
- 17.2.4 The Contractor shall liaise with the Engineer in developing a uniform identity code system which shall be used to uniquely identify each item of equipment and software component provided under this Contract and provided by the Other Interfacing Contractor(s) and/or Indian Railway.
- 17.2.5 Such identity codes shall be used for labelling each item of equipment and shall also be used in design reports, drawings and operations and maintenance manuals. Such codes shall comprise mnemonics for location names and equipment types as well as alpha-numeric for unique numbering.
- 17.2.6 The Contractor shall undertake site activity co-ordination with the Other Interfacing Contractor(s) and/or Indian Railways within the periods stated for access and installation interfacing and co-ordination in the agreed Installation Plan.
- 17.2.7 The Contractor shall undertake installation and testing in accordance with the milestones set in the Contract and the dates in Other Interfacing Contractor(s) and/or Indian Railways.
- 17.2.8 The Contractor shall undertake a lead role in the co-ordination of the activities associated with integrated systems testing including the co-ordination of Other Interfacing Contractor(s) and/or Indian Railways to test and monitor their systems to prove the design and integrity of the systems as a whole.
- 17.2.9 It shall be the responsibility of the Contractor to secure from the Other Interfacing Contractor(s) and/or Indian Railways, in a timely and correct manner as per the agreed Installation Plan, whatever interface provision is required for the Contractor to carry out its duties under the Contract.
- 17.2.10 Any additional cost arising to the Contractor due to his late and/or improper interfacing with the Other Interfacing Contractor(s) and/or Indian Railways, shall be to the Contractor's account. Such improper interfacing shall include, but not be limited to:
- (1) Late provision of interfacing information
 - (2) Failure to adhere to agreed interface
 - (3) Changing an interface after it has already been agreed and signed off.

17.3 Telecom System Interface Requirements

- 17.3.1 The Contractor shall coordinate with Other Interfacing Contractor(s) working in the section viz. CST Contractor(s) for Buildings & Structures and Track and any other contractor engaged by Employer for Dadri-Khurja section of EDFC.
- 17.3.2 The Contractor shall have to exchange information with CST Contractor(s) for the following, but shall not be limited to:
- (1) Regarding track alignment, rail levels, gradient, curve details, track center along with transition curve details.

- (2) Right of Way and Access free of encumbrances to sites on Main Line and at Stations.
- (3) HDPE/GI Pipes below tracks of requisite size for track-crossing of Signalling & Telecom Cables.
- (4) Telecommunication requirement of Track Alignment, Service Buildings, Yard Layouts etc., including the access dates and various milestone dates so as to co-ordinate the Telecommunication Works under this Contract.
- (5) All the information regarding Telecommunication design and execution, which may be reasonably needed by CST Contractor(s) to design and execute their works under their Contract.

SN	Interface Subject	Contractor	CST Contractor
1	Design and Construction of Telecom Equipment Room (TER) and Telecom Power Supply Equipment Room(s) as part of Station Building at Station.	<ol style="list-style-type: none"> 1. Shall provide the requirement of ventilation and flooring. 2. Shall provide the requirement of cable ducts in the floor & cable-entry locations in the rooms. 3. Shall advise the size and location of cable pits being constructed at cable inlet points. 	1. Shall design and construct the rooms.
2	Design and Construction of additional Telecommunication structures in Station area	Shall decide the space for construction of any additional Telecommunication structures in Station area in coordination with the CST contractor.	Shall give consent for construction of any additional Telecommunication structures in Station area
3	Design and Construction of Room(s) at IMSD for Telecom equipment.	<ol style="list-style-type: none"> 1. Shall provide the requirement of ventilation and flooring. 2. Shall provide the requirement of cable ducts in the floor & cable-entry locations in the rooms. 3. Shall advise the size and location of cable pits being constructed at cable inlet points. 	Shall design and construct the rooms.
4	Telecom Equipment Room (TER) and Telecommunication Power Supply Equipment Room(s) in Block Sections and at Interfacing IR Stations.	Shall decide the space (Site Plans) for construction of TER and Power Supply Equipment rooms in coordination with the CST Contractor.	Shall give consent for construction of TER and Power Supply Equipment rooms
5	Radio Towers at Stations and in Block Sections.	<ol style="list-style-type: none"> 1. Shall provide requirement of the location and space for Radio Towers. 2. Shall construct the Radio Towers. 	1. Shall incorporate this requirement in relevant drawings.

6	Trenching for trackside cable laying.	Shall decide the route for cable trenching in coordination with the CST contractor.	1. Shall give consent for trenches as required by Telecommunication for their cable laying. 2. Shall provide drawings for any underground services laid by him.
7	Cable passage requirement on bridges/culverts	Shall draw out sketches and provide to CST Contractor for requirement of cable laying on bridges/Culverts	Shall provide space for laying GI pipes/ Troughs on bridges and Culverts.
8	Track/Road/Platform crossing of cables.	Shall decide the Track/Road/Platform crossing locations, required for Telecommunication Work in coordination with the CST contractor.	1. Shall give consent for Track/Road/Platform crossings of Telecommunication Cables as per their requirement. 2. Shall advise location of RCC pipes as laid by them for Telecommunication cable crossings.

17.3.3 The Contractor shall interface and coordinate with Other Interfacing Contractor(s) working in the adjoining sections of EDFC & WDFC under Contract Packages CP-104, CP-203, STP-5 and CTP-14 for integration of Telecom System as per the requirements stipulated in this Particular Specifications.

17.3.4 Interface Requirements with Indian Railway

- (1) Contractor shall liaison with designated authorities in Indian Railway to develop integrated design of Mobile Train Radio Communication System based on GSM-R System as stipulated in relevant chapter of Particular Specification for Telecommunication. The design so finalised shall be submitted to Engineer for review. Contractor shall further liaison with designated authorities in Indian Railway for Installation, Testing & Commissioning of this integrated GSM-R System.
- (2) Contractor shall liaison with designated authorities in Indian Railway to design Telecom Arrangement for/at boundaries with Indian Railways. The design so finalised shall be submitted to Engineer for review and approval. The contractor shall execute the so approved Telecom Arrangement for/at boundaries with Indian Railways.

The Contractor shall also coordinate with Government Departments etc., as required, for timely completion of the Work.

17.3.5 Interface requirements specified above are by no means exhaustive and it remains the Contractors' responsibilities to develop, update and execute jointly Interface Requirements during design & throughout the execution of Works, to ensure that:

- (1) all interface issues between the Contracts/Systems are satisfactorily resolved;
- (2) design, supply, installation and testing of equipment are fully co-ordinated; and
- (3) all equipment and facilities supplied under the Contracts are fully compatible with each other, whilst meeting the requirements of the respective Specifications.

End of Chapter-17

APPENDIX – I

Fax : 91-0522-2458500
Telephone: 91-0522-2451200(PBX)
91-0522-2450115 (DID)

Government of India Ministry of Railways
Research Designs & Standards Organisation
LUCKNOW-226011

No. STT/WL/MTRC/503

Dated: 16.09.2005

To,

- The CSTE & CSTE / Construction,
1. Eastern Railway, Fairly Place, Kolkata – 700001
 2. Northern Railway, Baroda House, New Delhi – 110001
 3. Northeast Frontier Railway, Maligaon, Gowahati – 781011
 4. North Central Railway, Allahabad

**Sub: Uniform Numbering Scheme for Mobile Train Radio Communication
Network for Indian Railways.**

Uniform Numbering Scheme for Mobile Train Radio Communication has been prepared by RDSO for implementation on Zonal Railways. It is proposed to have network name as IR-GSM-R (maximum 8 Character), which will be displayed on mobile instruments. Railway Access Code (RAC) of Indian Railway MTRC network will be 091.

Presentation on numbering scheme was made on 15.09.2005 in the Railway Board during review of progress of MTRC sanctioned works. A copy of Uniform Numbering Schema for Mobile Train Radio Communication is sent herewith for comments.

It is requested that the comments on the numbering scheme may be sent to RDSO/ Lucknow within SEVEN days for finalizing the Numbering Scheme. If no reply is received within SEVEN days, it will be presumed that there is no comment from Railway Uniform Numbering Scheme is required by Eastern Railway and N.F. Railway for planning and programming of SIM cards and other functional requirements.

(A.K. Mishra)
Director/Std../Tele-II
For Director General/Telecom

DA: As above.

NUMBERING SCHEME FOR MOBILE TRAIN RADIO COMMUNICATION NETWORK OF INDIAN RAILWAYS

1. International Mobile Subscriber Identity (IMSI)

Railway	MCC	MNC	MSIN	
			HLR Identification Code	
Zone	405	48	8 digit as listed below	00000000-99999999

For Eastern Railway, IMSI numbers will be

Railway	MCC	MNC	MSIN	
			HLR Identification Code	
Eastern Railway	405	48	250	00000000-99999999

- Numbers from 0000000 to 9999999 can be used depending on numbers of SIM cards. Eastern Railway will be using only 410 SIM cards. Initially; the numbers to be used will be from 0000000-0000410. The balance may be kept as reserve to cater for future procurement.
- If each Railway (18 nos.) will be having separate MSC and HLR, then they will be having separate HLR identification code i.e. 250 for Eastern Railway, 100 for Central Railway and so on as per table given below. If any two or more zones use same HLR, then they will be having same HLR identification code.

Railway	HLR Identification Code
Central Railway	100
East Central Railway	150
East Coast Railway	200
Eastern Railway	250
North Central Railway	300
North Eastern Railway	350
North Western Railway	400
North East Frontier Railway	450
Northern Railway	500
South Central Railway	550
South East Central Railway	600
South Eastern Railway	650
South Western Railway	700
Southern Railway	750
West Central Railway	800
Western Railway	850

2. Mobile Subscriber ISDN Number (Call Type 8) for Eastern Railway:

Railway	CC	NDC		CT 8	Subscriber Number			
		AC	ZONE		HQ/Divn.	Deptt.		
Eastern Railway HQ	91	99	25	8	0	0	GM	0000-0199
							Vigilance	0200-0299
							CPRO	0300-0399
							Law	0400-0499
							Civil Defence	0500-0599
							Audit	0600-0699
							Reserved	0700-0999
							MSRN, HON, GCN	1000-1999
							Reserved	2000-9999
	91	99	25	8	0	1	Personnel and Commercial	0000-9999
							Officers (Personnel)	0000-0099
							Supervisors (Personnel)	0100-0299
							Reserved	0300-0999
							Officers (Commercial)	1000-1099
							Supervisors (Commercial)	1100-1299
							Reserved	1300-1999
							Reserved	2000-9999
							91	99
	Officers (Security)	0000-0099						
	Supervisors (Security)	0100-0299						
	Reserved	0300-0999						
	Officers (Medical)	1000-1099						
	Supervisors (Medical)	1100-1299						
	Reserved	1300-1999						
	Reserved	2000-9999						
	91	99	25	8	0	3		
							General	0000-0299
Officer (Maint.+Con.)							0000-0049	
Supervisor (Maint.+Con.)							0050-0199	
Reserved							0200-0299	

Eastern Railway HQ							TRD	0300-0599
							Officer	0300-0349
							(Maint.+Con.)	
							Supervisor	0350-0449
							(Maint.+Con.)	
							Tower Wagon	0450-0459
							Reserved	0460-0599
							TRS	0600-0999
							Officers	0600-0649
							Supervisors	0650-0749
							Driver	0750-0999
							Reserved	1000-9999
	91	99	25	8	0	4	Engineering	0000-9999
							Officer	0000-0099
						(Maint.+Con.)		
						Supervisors	0100-0299	
						(Maint.+Con.)		
						Reserved	0300-9999	
91	99	25	8	0	5	Operating	0000-9999	
						Officer	0000-0099	
						Supervisor	0100-0299	
						Guard	0300-0599	
						Station Master	0600-0899	
						Reserved	0900-9999	
91	99	25	8	0	6	Mechanical	0000-9999	
						C & W	0000-0399	
						Officer	0000-0049	
						Supervisor	0050-0199	
						Reserved	0200-0399	
						Power	0400-0699	
						Officer	0400-0449	
						Supervisor	0450-0499	
						Driver	0500-0689	
						ART	0690-0699	
						Diesel	0700-0999	
						Officer	0700-0749	
						Supervisor	0750-0799	
						Reserved	0800-9999	
91	99	25	8	0	7	S & T	0000-9999	
						Officer	0000-0049	
						(Maint.+Con.)		
						Supervisors	0050-0249	
						(Maint.+Con.)		
						Reserved	0250-9999	
91	99	25	8	0	8	Stores	0000-9999	
						Officer	0000-0049	
						(Maint.+Con.)		
						Supervisors	0050-0299	
						(Maint.+Con.)		

Eastern Railway HQ							Reserved	0300-9999
	91	99	25	8	0	9	Accounts	0000-0999
							Officer (Maint.+Con.)	0000-0999
							Supervisors (Maint.+Con.)	0100-0299
							Reserved	0300-9999
Eastern Railway Howrah Division	91	99	25	8	1	Same as HQ	Same as HQ	Same as HQ
Eastern Railway Asansol Division	91	99	25	8	2	Same as HQ	Same as HQ	Same as HQ
Eastern Railway Sealdah Division	91	99	25	8	3	Same as HQ	Same as HQ	Same as HQ
Eastern Railway Malda division	91	99	25	8	4	Same as HQ	Same as HQ	Same as HQ

Numbering scheme for MSISDN number is for Eastern Railway for MSISDN numbers of other railways, ZONE code will be different as mentioned below.

Railway	ZONE
Central Railway	10
East Central Railway	15
East Coast Railway	20
North Central Railway	30
North Eastern Railway	35
North Western Railway	40
North East Frontier Railway	45
Northern Railway	50
South Central Railway	55
South East Central Railway	60
South Eastern Railway	65
South Western Railway	70
Southern Railway	75
West Central Railway	80
Western Railway	85

Besides two digit Zone code, one digit has been allotted to distinguish zonal headquarter and divisions, i.e. 0 for headquarter, 1 for first division, 2 for second division and so on. Similarly one digit has been identified for various departments in Zonal headquarter and divisions, i.e. 0 for Administration, 1 for Personnel & Commercial Deptt, 2 for Security & Medical Deptt, and so on.

3. Short Codes and Call Type 1 (CT 1):

Location Dependent Addressing (LDA) and Integrated Acknowledgment Center (IAC)

Digits Family	Digits Range		Digits #	Remarks
	From	To		
1 LDA	1200	1200	4	Route to most appropriate Primary Controller
	1300	1300	4	Route to Secondary Controller
	1301	1301	4	Route to C & W Control
	1302	1302	4	Route to Engineering Control
	1303	1303	4	Route to Traction Power Control
	1304	1304	4	Route to S&T Control
	1305	1305	4	Route to Security Control
	1306	1306	4	Route to Commercial Control
	1400	1400	4	Route to Power Controller
1 IAC	1612	1612	4	High priority call confirmations including Railway Emergency Calls
Short Codes	299	299	3	Train Groups: Emergency Call
	569	569	3	Trackside Maintenance Groups: Emergency Call
	599	599	3	Shunting Groups: Emergency Call

NOTE: 1201 to 1599 can be used for other secondary controllers.

4. Train Function Number (9 Digits) (Call Type 2):

CT (1 Digit)	Day (1 Digit) (Schedule originating day of train)	Train Running Number (5 Digit) XXXXX	Function Code (2 Digit)	Remarks
2	1-Monday	First Four digits will be as per train number and last digit will for type of train i.e. schedule train, link train or summer special train	01	Leading Driver
	2-Tuesday		10	Chief Conductor
	3-Wednesday		20	Catering Staff Chief
	4-Thursday		30	Railway security services chief
	5-Friday		80	Guard
	6-Saturday			
	7-Sunday			

NOTE:

XXXX = Four Digit Train Number. The last digit Y will be some numeric depending on the type of train i.e.

Y = 0 for scheduled trains

Y = 1 for link trains

Y = 2 for summer special/ holiday special trains.

5. Engine Function Number (11 Digits) (Call Type 3):

CT (1 digit)	Zone (2 digit)	Engine Number (6 Digit)	Function Code (2 Digit)	Remarks
3	As per ZONE Code of MSISDN	Last five digits will be as per the number of engine and first digit will be zero.	01 80	Leading Driver Guard

NOTE:

Goods trains can be identified by Engine Function Number.

6. Voice Broadcast Service (VBS) & Voice Group Call Service (VGCS) Number Plan (10 digits):

Call Type (CT) 50 for Group Call and Call Type (CT) 51 for Broadcast Call.

Call Type (CT) (2 digit)	Service Area Indicator (SA) (5 digits)	Group ID (GID) (3 digit)	Remarks
50 or 51	LLL03 (First Service area) Note: LLL is Location Number of Service Area. Zone = 2 digit. Division = 1 digit same as MSISDN. For example, for ER/HWH LLL = 251, for ER/SDAH LLL=252	200	Train Group: Drivers
		201	Train Group: Conductors
		202	Train Group: Catering
		203	Train Group: Guards
		204	Train Group: Security
		205	Accident Relief Train Group
		206	Emergency Doctor Group
		207-298	Reserved
		299	Train Group: Emergency Call
		500	Default shunting group
		501-520	Reserved for other shunting groups
		530	Station Staff (SM) group
		531	Security staff group
		539	Station and security staff: emergency call
		560	Engg. trackside maintenance group
		561	S&T maintenance group
		562	Electrical Maintenance group
563	Mechanical maintenance group		
569	Trackside Maintenance group: Emergency Call		
		570	Controller group
		579	Controller Group: Emergency call
		599	Shunting group: Emergency call
50 or 51	LLL01 (Second Service area)	DO	DO
50 to 51	LLL02-LLL99 (reserved for other	DO	DO

	service areas in a Division of a Zone)		
--	--	--	--

- 50: Group call in the defined service area.
 51: Broadcast call in the defined service area.

7. Maintenance and Shunting Team Numbers (Call Type 6):

CALL TYPE (CT)	LOCATION NUMBER (LLLLL) (5 Digit)	FUNCTION CODE, FC (TT, Y, XX) (4 Digit)	Remarks
6	LLLLL is location number where Called Party is registered. Zone=2 digit, Division=1 digit same as MSISDN. For two LL as 00 Last Three LLL as Zone and Division For example 00250=ER/HQ 00251=ER/HWH 00252=ER/SDAH 00253=ER/ASN 00254=ER/MLDT	TT=5 for Shunting Team	TT= Team Type (1 Digit)
		TT=6-9 used for Maintenance Teams	
		TT=6 (S&T Maintenance Team-Signal and Telecom)	
		TT=7 (Electrical General, TRD, TRS)	
		TT=8 (Mechanical C&W, Diesel, Power)	
		TT=9 (Engineering P Way & Works)	
		Y=0 (TT=5) for Shunting Leader	Y= Team Member Function (1 Digit)
		Y=1-3 for Shunting Team Member	
		For TT=6-9, Y=0-9 is available for team leader and members	
		XX=00-99 available as team number for TT=6-9	XX=Team Number (2 Digit)
		FC for Maintenance team Number	
		6 0 00 (1 st S&T maintenance team leader)	
		6 1 00 (1 st S&T maintenance team-1 st member)	
	6 2 00 (1 st S&T maintenance team-2 nd member)		
	6 0 01 (2 nd S&T maintenance team-leader)		
	6 1 01 (2 nd S&T maintenance team –Leader)		
	6 2 01 (2 nd S&T maintenance team-2 nd member)		
	Same pattern will be applicable for other teams also.		

8. Functional Structured Number (FSN) for Train Controller (Call Type 7):

Digits Family	Digits Range		Digits #	Remarks
	From	To		
FSN	7 LLLLL 01	7 LLLLL 01	8	Controller 1
FSN	7 LLLLL 02	7 LLLLL 02	8	Controller 2
FSN	7 LLLLL 03	7 LLLLL 03	8	Controller 3
FSN	7 LLLLL 04	7 LLLLL 04	8	Controller 4
FSN	7 LLLLL 11	7 LLLLL 99	8	Controller 5

LLLLL (5 digits) reserved for Location Number as specified in Call Type 8. For example: Zone + Division Code of HWH is 251. Therefore LLLLL for HWH Division of Eastern Railway will be 00251. Thus Primary Controller Functional Structured Number will become 70025101 (8 Digits).

APPENDIX – II

**Details of Network Sub-system (NSS) of
 MTRC System of Indian Railways**

MSC Make: Nokia Solutions and Networks (NSN)
Model: D900
Version: SR14/CS6.0
Capacity: 4K
Country of Manufacture: NSN Germany
Interfaces and Connectivity Details:

Integrated MSC/HLR Node interfaces	E1 ISUP	E1 PRI	SS7 Channelized	SS7 V.35
BSS (A Interface)	19		2	
PSTN	3		2	
IWF	2			
SCP			2	
Railways Fixed Network		3		
Call Recording System	4		2	
Total	28	3	8	2



BID DOCUMENT

FOR

DESIGN, SUPPLY, CONSTRUCTION, INSTALLATION, TESTING AND COMMISSIONING OF 2X25KV AC ELECTRIFICATION, SIGNALLING & TELECOMMUNICATION, E&M AND ASSOCIATED WORKS ON DESIGN-BUILD LUMP SUM BASIS FOR DADRI-KHURJA SECTION (APPROXIMATELY 47 ROUTE KM OF DOUBLE LINE) OF EASTERN DEDICATED FREIGHT CORRIDOR

SYSTEMS WORKS CONTRACT PACKAGE 105

Issued on: 14.06.2017

ICB No.: HQ/SYS/EC/D-B/Dadri– Khurja

EMPLOYER'S REQUIREMENTS

PART-2, SECTION-VI,

VOLUME 5: PARTICULAR SPECIFICATIONS – E&M AND ASSOCIATED WORKS

**EMPLOYER: DEDICATED FREIGHT CORRIDOR CORPORATION OF INDIA LTD
(A GOVERNMENT OF INDIA ENTERPRISE)**

MINISTRY OF RAILWAYS

COUNTRY: INDIA

Table of Contents

PART 1 – Bidding Procedures

- Section I. Instructions to Bidders
- Section II. Bid Data Sheet
- Section III. Evaluation and Qualification Criteria (Following Prequalification)
- Section IV. Bidding Forms
- Section V. Eligible countries

PART 2 – Employer's Requirements

- Section VI. Employer's Requirements
- Volume 1: General Specifications
- Volume 2: Particular Specifications – 2x25 kV, AC Traction Electrification and Associated Works
- Volume 3: Particular Specifications – Signalling Works
- Volume 4: Particular Specifications – Telecommunication Works

Volume 5: Particular Specifications – E&M and Associated Works

PART 3 – Conditions of Contract and Contract Forms

- Section VII. General Conditions (GC) As per FIDIC Yellow Book 1999-Edition
- Section VIII. Particular Conditions
 - *Appendix to Tender*
- Section IX. Contract Forms

PART 4 – Reference Documents

1. Alignment Plans, Yard Plans and Building Plans
2. Power Supply, Distribution, OHE and SCADA system Schemes & layouts and S&T Drawings
3. DFCC-Environmental Assessment Report for Khurja - Dadri Section
4. Environmental Management Framework(EMF) for EDFC
5. DFCC– Resettlement Action Plan for Khurja- Dadri Section
6. DFCC-SHE Manual
7. Specification for 12000hp locomotive and Tractive effort Curve
8. IR's Transmission line Network and DFCCIL's Traction Sub Station (TSS) Connectivity

VOLUME-5: PARTICULAR SPECIFICATIONS: E&M AND ASSOCIATED WORKS

TABLE OF CONTENTS

CHAPTER 1 - INTRODUCTION AND OBJECTIVES.....	7
1.1 INTRODUCTION	7
1.2 OBJECTIVES.....	7
1.3 PROJECT OVERVIEW.....	8
CHAPTER 2 - ABBREVIATIONS, TERMS & DEFINITIONS AND STANDARDS	9
2.1 ABBREVIATIONS	9
2.2 TERMS & DEFINITIONS	10
2.3 APPLICABLE CODES AND DESIGN STANDARDS	11
CHAPTER 3 - SCOPE OF WORKS.....	13
3.1 GENERAL.....	13
3.2 SCOPE OF E&M AND ASSOCIATED WORK	13
3.3 E&M SCOPE FOR SERVICE BUILDINGS, ANCILLARY BUILDINGS AND STAFF QUARTERS	16
3.4 INCIDENTAL WORKS.....	18
CHAPTER 4 - DESIGN CRITERION AND PROCEDURES	20
4.1 GENERAL DESIGN CRITERIA	20
4.2 DESIGN CRITERION AND DESIGN REQUIREMENT	22
4.3 CONTRACTOR'S RESPONSIBILITIES.....	26
4.4 SUBMISSION OF DRAWINGS AND DOCUMENTS	28
4.5 GENERAL DESIGN CRITERIA FOR SERVICE BUILDINGS AND OTHER STRUCTURES.....	29
4.6 EMPLOYER'S REQUIREMENTS - FUNCTIONAL.....	31
4.7 OPERATION CONTROL CENTRE (OCC) (constructed by other designated contractor of CP 104 of EDFC)	32
4.8 THE EQUIPMENT AND FACILITIES PROVIDED BY THE CONTRACTOR (CP-105) FOR AUXILIARY SCADA.....	32
4.9 ANCILLARY BUILDINGS CONSTRUCTION	33
CHAPTER 5 - DISTRIBUTION TRANSFORMER	35
5.1 GENERAL	35
5.2 SPECIFICATIONS.....	35
5.3 PERFORMANCE.....	35
5.4 IMPULSE STRENGTH OF WINDINGS	35
5.5 FREQUENCY	35
5.6 EXTERNAL SHORT CIRCUITS.....	35
5.7 EFFICIENCY AND REGULATION.....	36
5.8 FOUNDATION AND FENCING FOR TRANSFORMER.....	36
5.9 CLEARANCES.....	36

5.10	TYPE TEST AND ACCEPTANCE TEST	36
5.11	SAFETY ITEMS	37
	CHAPTER 6 – HT / LT SWITCHGEARS AND THEIR ENCLOSERS	38
6.1	HT SWITCHGEAR	38
6.2	LT SWITCHGEAR	41
	CHAPTER 7- CABLES	54
7.1	GENERAL	54
7.2	HT Cable	54
7.3	LT CABLE	55
7.4	LAYING OF HT / LT CABLE	57
7.5	CABLE SEALING SYSTEM	59
7.6	TESTING AND COMMISSIONING	60
	CHAPTER 8–WIRING, CONDUIT, CABLE TRAY AND RACEWAY	61
8.1	GENERAL	61
8.2	MATERIAL DESCRIPTION	61
8.3	COMPONENTS	61
8.4	WIRING	63
8.5	APPROVAL OF MATERIAL, FIRST FIX FOR ELECTRICAL INSTALLATION	63
8.6	TESTING AND COMMISSIONING	63
	CHAPTER 9– LIGHTING SYSTEM	64
9.1	GENERAL	64
9.2	SYSTEM DESCRIPTION	64
9.3	GENERAL REQUIREMENTS	65
9.4	OUTDOOR ILLUMINATION	65
9.5	INDOOR ILLUMINATION	65
9.6	INTERNAL WIRING OF SERVICE BUILDINGS, STAFF QUARTERS, CLUB / INSTITUTE AND OTHER ANCILLARY AND ASSOCIATED BUILDINGS	66
9.7	MATERIAL DESCRIPTION	66
9.8	COMPONENTS	67
9.9	SIGNAGE	68
9.10	LED STREET LIGHT LUMINAIRES	68
9.11	SWITCH AND SOCKET OUTLET	68
	CHAPTER 10 – SCADA SYSTEM FOR AUXILIARY POWER SUPPLY	70
10.1	SCOPE	70
10.2	GENERAL REQUIREMENTS	70
10.3	FUNCTIONAL REQUIREMENTS	72
	CHAPTER 11- DIESEL GENERATOR SET (DG SET)	74
11.1	GENERAL	74
11.2	MATERIAL DESCRIPTION	74

11.3	TESTING AND COMMISSIONING.....	77
11.4	EARTHING.....	78
	CHAPTER 12- FIRE DETECTION AND ALARM SYSTEM.....	79
12.1	GENERAL.....	79
12.2	FUNCTIONAL REQUIREMENT.....	79
12.3	POWER SUPPLY.....	80
12.4	TESTING AND COMMISSIONING.....	82
	CHAPTER 13 – FIRE SUPPRESSION SYSTEM.....	84
13.1	GENERAL.....	84
13.2	CODES AND STANDARDS.....	84
13.3	PORTABLE FIRE EXTINGUISHERS.....	84
13.4	FIRE BUCKETS.....	84
	CHAPTER 14-EARTHING, BONDING AND LIGHTNING PROTECTION SYSTEM.....	86
14.1	GENERAL.....	86
14.2	APPLICABLE STANDARDS AND CODES.....	86
14.3	MATERIAL DESCRIPTION.....	86
14.4	CRITERIA.....	86
14.5	LIGHTNING PROTECTION SYSTEM.....	87
14.6	INSTALLATION.....	87
14.7	TESTING AND COMMISSIONING.....	87
	CHAPTER 15- AIRCONDITIONING & VENTILATION SYSTEM.....	88
15.1	GENERAL.....	88
15.2	STANDARDS & CODES.....	88
15.3	BASIS OF DESIGN.....	88
15.4	AIR-CONDITIONING SYSTEM PERFORMANCE REQUIREMENT.....	89
15.5	AIR CONDITIONING AND VENTILATION BY THE CONTRACTOR AT STATIONS, IMD AND IMSDS AND CONTROL ROOM BUILDING.....	89
	CHAPTER 16 - SOLAR POWER SYSTEM.....	90
16.1	GENERAL.....	90
16.2	SYSTEM DESCRIPTION.....	90
16.3	GENERAL REQUIREMENTS.....	90
16.4	TECHNICAL REQUIREMENTS.....	91
16.5	INSTALLATION & COMMISSIONING.....	99
	CHAPTER 17- CIVIL WORKS.....	101
17.1	GENERAL.....	101
17.2	GEOTECHNICAL INVESTIGATION.....	101
17.3	ELECTRICAL RESISTIVITY OF SOIL.....	101
17.4	LAND PREPARATION.....	102
17.5	ROAD & CULVERTS.....	102

17.6 DRAINAGE.....	103
17.7 FOUNDATION WORK.....	103
17.8 CABLE & PIPE TRENCHES.....	104
17.9 GRAVEL SPREADING	105
17.10 FINISHING	105
17.11 GATES AND FENCING	105
17.12 SWITCH YARD LIGHTING.....	105
17.13 ANCILLARY BUILDING:	106
17.14 CIVIL & STRUCTURAL DESIGN.....	106
17.15 ARCHITECTURAL SERVICES.....	107
17.16 E&M / BUILDING SERVICES	107
17.17 GENERAL REQUIREMENTS FOR S&T BUILDINGS.....	108
17.18 GENERAL REQUIREMENTS FOR CONTROL ROOM BUILDINGS (ELECTRICAL).....	108
17.19 WALLS, CEILING & FLOORS.....	109
17.20 DOORS AND WINDOWS	109
17.21 VENTILATION.....	109
17.22 BATTERY ROOMS.....	110
17.23 WATER SUPPLY, ELECTRICITY, SANITATION.....	110
17.24 EXTERIOR FINISH.....	110
17.25 INTERNAL EQUIPMENT	110
17.26 LIGHTING & POWER.....	111
17.27 EMERGENCY LIGHTING	111
17.28 LIGHTING EQUIPMENT.....	111
17.29 POWER SOCKETS	111
17.30 SAFETY EQUIPMENT.....	111
17.31 CABLE PATHS	112
17.32 SIGNAGE.....	112
CHAPTER 18– UNINTERRUPTED POWER SUPPLY (UPS).....	113
18.1 GENERAL.....	113
18.2 SUBMITTAL.....	113
18.3 MATERIAL DESCRIPTION	113
18.4 PHYSICAL REQUIREMENT.....	114
18.5 CONTROL AND ANNUNCIATION SYSTEM	115
18.6 INSTALLATION.....	116
18.7 TESTING.....	116
CHAPTER 19 – ACCESS CONTROL SYSTEM.....	117
19.1 GENERAL.....	117
19.2 SCOPE OF WORK.....	117
19.3 FUNCTIONAL REQUIREMENTS.....	117

19.4 PERFORMANCE REQUIREMENTS.....	118
CHAPTER-20-ATTACHMENTS	119
Attachment 20.1: Schedule of Electrical Fixtures – Junction Station	119
Attachment 20.1: Schedule of Electrical Fixtures-IMSD	120
Attachment 20.2: Typical Type of Fittings & Illumination Level at Various Locations	121
Attachment 20.3: Power Supply Arrangement	122
Attachment 20.4: Matrix of Required Facilities at Various Locations	123
Attachment 20.5: Standard List of Electrical Fittings in Quarters.....	124
Attachment 20.6: Applicable Codes and Design Standards.....	125
Attachment 20.7: Indicative Scheme for Auxiliary Power Supply System.....	132

CHAPTER 1 - INTRODUCTION AND OBJECTIVES

1.1 INTRODUCTION

- 1.1.1 This document pertains to Employer's requirements, guidelines and specifications of E&M and Associated Works of the Dadri – Khurja section of approximately 47 route kilometers length, forming the northern most leg of the double line EDFC (Eastern Dedicated Freight Corridor), to be constructed and electrified at 2x25 KV Auto Feed system, by DFCCIL (Dedicated Freight corridor Corporation of India Ltd.), a public sector undertaking, set up under the Indian Companies Act 1956 for implementation of Dedicated Freight Corridor Project. Government of India is the sole shareholder of the DFCCIL. DFCCIL has planned to construct a Dedicated Freight Corridor (DFC) covering about 3330 route kilometers on Eastern and Western Corridors. The coverage of Eastern Corridor is from Ludhiana to Dankuni and that of Western Corridor from Jawaharlal Nehru Port, Mumbai to Rewari / Tughlakabad / Dadri near Delhi. There will be a linkage between the two corridors at Dadri.
- 1.1.2 Eastern DFC Route will be approximately 1847 Km long from Dankuni to Sahnewal (near Ludhiana) via Asansol – Dhanbad – Gaya – Sonnagar – Mughalsarai – Allahabad - Kanpur – Tundla –Khurja - Meerut – Saharanpur& Ambala.
- 1.1.3 The section between Mughalsarai – Sahnewal (1183 km) is being financed by the World Bank.
- 1.1.4 EDFC Phase-1 covers the construction of double line electrified section of approximately 343 route km length between Bhaupur and Khurja (under Contract Package, CP-104) and about 47 Km double line (under contract package CP -105) between Khurja and Dadri, where it links with Western Dedicated Freight Corridor (WDFC).
- 1.1.5 EDFC Phase-2 covers the construction of electrified section covering a route length of approximately 388.14 route km length (Double Line) and approximately 29.15 route km length (Single line) between Mughalsarai and New Bhaupur .
- 1.1.6 EDFC Phase-3 involves construction of single line electrified track of about 404 route km. between Khurja-Meerut-Saharanpur-Ambala-Sahnewal (near Ludhiana).
- 1.1.7 The EDFC entails construction of mostly double-track, 2x25 kV, 50 Hz, electrified railway lines. The bridges and formation will be designed for 32.5T axle load while the track structure will be designed for 25T axle load operating at train speed of up to 100 Kmph. The Eastern Corridor will handle single stack containers whereas Western Corridor is planned to cater to double stack containers. Up-gradation of transportation technology, increase in productivity and reduction in unit transportation costs have been taken as guiding principles for formulating the project.

1.2 OBJECTIVES

- 1.2.1 The Objective of these specifications is to describe the requirements for the design, supply, construction, installation, testing and commissioning of E&M and associated works for Dadri – Khurja section of the Eastern Dedicated Freight Corridor as per the terms and conditions stipulated in the contract to achieve the standard, performance in conformance to relevant standards and requirements, performance benchmarks specified in the contract to render a satisfactory designed life with minimum maintenance costs, high Availability, Low Life Cycle Cost (LCC) and minimum energy consumption and Carbon footprint.

- 1.2.2 In full recognition of the purpose, and the full acceptance of the obligation, liabilities & risks that may be involved, the contractor shall undertake the design, supply, construction, installation, testing and commissioning of the E&M and associated work (including and without limitations the design, construction and removal of all the temporary works/debris) and handover the completed works to the employer in a condition in which the employer shall immediately use the works for the intended purpose and/or to make them available to the other contractors who shall commence and carry out their works without delay or disruption. In full recognition of these objectives and full acceptance of the obligations, the contractor shall execute the works taking into account all liabilities and risks that may be involved.
- 1.2.3 The contractor shall be responsible for designing, preparation of drawings for E&M and associated work, obtaining all necessary approvals from the relevant authorities in design, construction and commissioning of the works. In addition, the contractor shall be responsible for rectification of the defects in the permanent works in the manner and to the standard as stipulated in the contract.

1.3 PROJECT OVERVIEW

- 1.3.1 The execution of Dadri – Khurja section of EDFC has been planned through two (2) Design & Build Contracts as under:-
- a. CST: Civil , Structures (Buildings), Track (& Bridges) Works - CP-302
 - b. Systems Works: 2x25kV AC Traction Electrification, Signalling & Telecommunication, E&M and Associated Works - CP 105.
- 1.3.2 The Dadri – Khurja section of EDFC is located between Khurja & Dadri along the Mughalsarai – New Delhi main line section of the North Central Zone of Indian Railways..
- 1.3.3 Dadri – Khurja will have One (1) junction station at New Boraki and Nil Crossing Stations. The Alignment and Chainage details are given in General Specifications.
- 1.3.4 This section of the EDFC has been planned with One (1) Integrated Maintenance Sub Depot (IMSD) at New Boraki.
- 1.3.5 An Operation Control Centre (OCC) is being established centrally at Allahabad under the scope of work of CP-104 (EDFC). The monitoring & control of auxiliary Power system is provided by an Auxiliary Supervisory Control and Data Acquisition System (Aux. SCADA). Above OCC shall also cater to the space for SCADA of CP-105.
- 1.3.6 DFCC has planned residential complexes for its staff at different locations in the section.

(End of Chapter - 1)

CHAPTER 2 - ABBREVIATIONS, TERMS & DEFINITIONS AND STANDARDS

2.1 ABBREVIATIONS

List of Abbreviations used in this Specification are described hereunder:

AC	Alternating Current
A	Amperes
ALH	Auto Location Hut
APFC	Automatic Power Factor Correction
ASS	Auxiliary Substation
Aux AT	Auxiliary Transformer
AT	Auto Transformer
AN	Normal Air-cooled Transformer
ASTS	Auto Source Transfer Switch
BMS	Building Management System
BS	British Standard
C	Celsius or Centigrade
CCTV	Close Circuit Television
Cm or cm	Centimeter
CRCA	Cold Rolled Closed Annealed
DG	Diesel Generator
D&B	Design & Build
DOL	Direct On Line
DB	Distribution Board
ELCB	Earth Leakage Circuit Breaker
EMC	Electromagnetic Compatibility
ELV	Essential Low Voltage
E&M	Electrical & Mechanical
FRP	Fire Rated Proof
FRLS	Fire Retardant Low Smoke
FP	Four Pole
GSM – R	Global System for Mobile Communication - Railway
HDPE	High Density Poly Ethylene
HRC	High Rupturing Capacity
HT	High Tension
IEC	International Electro technical Commission
IER	Indian Electricity Rules, 1956
IMD	Integrated Maintenance Depot
IMSD	Integrated Maintenance Sub Depot
IR	Indian Railways
IRS	Indian Railway Standards
IS	Indian Standards
K	Kilo
Kg	Kilogram
kVA	Kilo Volt-Amp
kW	Kilowatt
LDB	Lighting Distribution Board

LED	Light Emitting Diode
LSZH	Low Smoke Zero Halogen
LT	Low Tension
MLDB	Main Lighting Distribution Board
MPDB	Main Power Distribution Board
M or m	Meter
MS	Mild Steel
mm	Millimeter
MCB	Miniature Circuit Breaker
MCCB	Moulded Case Circuit Breaker
N	Neutral
NBC	National Building Code of India
NFPA	National Fire Protection Association
O&M	Operation and Maintenance
OCC	Operation Control Centre
OFC	Optical Fiber Cable
Ph	Phase
PF or pf	Power Factor
PFC	Power Factor Controller
RTU	Remote Terminal Unit
PHE	Public Health Engineering
RDSO	Research Design and Standards Organization
SCADA	Supervisory Control and Data Acquisition
SAT	System Acceptance Test
SDB	Sub Distributing Board
SOGP	Schedule of Guaranteed Performance
SRS	System Requirement Specification
S&T	Signalling & Telecom
SER	Signal Equipment Room
TER	Telecom Equipment Room
TPN	Triple Pole With Neutral
UPS	Uninterruptible Power Supply
VCB	Vacuum Circuit Breaker
UL	Underwriters Laboratories Inc.
VFD	Variable Frequency Drive
V	Volt
XLPE	Cross Linked Polyethylene

2.2 TERMS & DEFINITIONS

E&M: Electrical and Mechanical (E&M) means the equipment associated with the Building services Including illumination, LV & MV Power distribution, ventilation, air-conditioning, Fire detection & alarm system and Fire suppression system including plumbing and health services etc.

In addition to the words and expressions defined in the Employer Requirement: General Specification, following words and expressions shall have meaning assigned to them except where the context otherwise requires.

2.3 APPLICABLE CODES AND DESIGN STANDARDS

- (1) Electrical Arrangement shall be based on BS: 7671-2001 "Requirements for Electrical Installations", IEEE for earthing, IEC or other internationally recognized standards. The E&M and associated works shall be executed in compliance to Codes and Standards as specified in attachment 20.6 of Chapter 20 on 'applicable codes and Design standards'.

The examples of applicable standards are as under:

IER	:	Indian Electricity Rules, 1956
IEA	:	Indian Electricity Act
BS	:	British Standards
ISO	:	International Standards Organization
EN	:	European Standard
IES	:	Illumination Engineering Society
NBC	:	National Building Code
ANSI	:	American National Standards Institute
ASME	:	American Society of Mechanical Engineers
DIN	:	Deutsche Industrie Normen
IEC	:	International Electro technical Commission
JIS	:	Japanese Industrial Standards
NEC	:	National Electrical Code
NEMA	:	National Electrical Manufacturers Association
NFPA	:	National Fire Protection Association
VDE	:	Verbena Deutsche Electro technique
BIS	:	Bureau of Indian Standards
ECBC	:	Energy Conservation Building Code
RDSO	:	Research Design & Standards Organization
CPCB	:	Central Pollution Control Board

- (2) The equipment to be supplied under this specification shall be designed, manufactured and tested in accordance with the latest International Standards such as IEC, EN or BS and relevant Indian Standards and IEC Code. Wherever RDSO specifications for particular system/equipment are available, the same shall be applied.
- (3) Unless otherwise stated, the E & M System shall be governed by all applicable local codes, codes of practice, regulations and standards (all latest) issued by agencies such as:
 - (a) Central Public Works Department
 - (b) Regulations for Electrical Crossing of Rail Track
 - (c) State Electricity Authority including Power Utility

- (d) National Safety Council
- (e) Chief Electrical Inspector
- (f) ASHRAE (American Society of Heating, Refrigerating & Air-Conditioning Engineers)
- (g) Central Pollution Control Board

The Contractor shall ensure compliance with the regulations laid down by local authorities and all other statutory agencies including fire safety regulations or other local codes and obtain approval from relevant authorities at appropriate stages of work as required.

- (4) Precedence/ Priority of Codes and Standards

The precedence is already specified in GS. However, the decision of the Engineer shall be final.

(End of Chapter-2)

CHAPTER 3 - SCOPE OF WORKS

3.1 GENERAL

These Specifications describe the Requirements of E&M and associated works for Design, Verification Manufacture, Verification, Supply, Installation, Testing and Commissioning of Electrical & Mechanical and associated works for Dadri- Khurja section under the scope as detailed below:

3.1.1 Responsibility of the Contractor

- (1) The Technical Specifications have been prepared based on the Preliminary Concept Design. However, the Contractor shall review the concept design and validate their design through simulations/ calculations and satisfy himself for adequacy for application duty & future requirement as identified and ensure that their proposed designs, capacities, ratings, specifications and quantities of equipment are sufficient to meet the functional, operational and performance requirements of the complete system in conformity with relevant standards and Good Industry Practices.
- (2) The Contractor shall be responsible for preparation and submission of Preliminary design, detailed design, Calculation/validation & simulation for sizing of the equipment & system provisions, manufacture, supply, installation, testing and commissioning (including integrated testing and Commissioning), trial running, O&M manuals, training, as Built Drawings & Documentation, supervision support during DNP, co-ordination and interface management with other Contractors and other Contract obligations.

3.2 SCOPE OF E&M AND ASSOCIATED WORK

3.2.1 The scope of works includes design, supply, manufacture, construction / installation, testing and commissioning of E&M and Associated Works for the Station building, DFCC staff quarters, Depot (IMSD), and other ancillary buildings like control rooms at TSS, SSPs, Auxiliary Substation, additional DG Room, Signal Equipment Rooms, Telecom Equipment Room and S&T Power Supply Equipment Rooms for Signalling and Telecommunication works in Block Section at Auto Location Huts, GSM-R locations and Interfacing IR Station as required and additional buildings, if any for Signalling and telecommunication works over and above the SER, TER and S&T Power Supply Equipment Rooms in Station and Block Section, and other associated buildings on Dadri - Khurja section, as under but not limited to:

- (1) Auxiliary Power Supply and Distribution System including 11kV Auxiliary Power sub-stations(ASS), internal and external electrification and other associated work etc. as per the following details : -
 - (a) 11kV power supply arrangement with redundant HT switchgears, protection and metering arrangement including the provision of Cabling between Auxiliary Sub Station (ASS) and the Point of Supply (ASS end);
 - (b) 11kV/ 0.433 kV Auxiliary Substation including provision of Transformer(s) at Station / Depot as required;
 - (c) LT Power Distribution System including LT Panels, Distribution Boards and LT Cables etc.;

- (d) Power factor improvement equipment as required to achieve power factor of 0.95;
 - (e) **Internal Electrification** of Buildings including provision of luminaires, cabling, service mains, distribution boxes, wiring in existing conduits (concealed conduit shall be provided by CST contractor (CP-302) and electrification of those buildings constructed by the Contractor (CP-105) etc.;
 - (f) **External Electrification** of following location including provision of lighting poles/masts, luminaires, cabling, service mains, distribution boxes, wiring etc.:
 - i. Circulating area of Service Buildings (i.e. Station, Depot) and Residential Buildings, Parking, approach road constructed by CST Contractor (CP 302)
 - ii. Switchyard & approach roads constructed by Contractor (CP 105).
 - (g) Power supply for Ventilation & Air-conditioning;
 - (h) Power supply as required for Water Pumping Installations;
 - (i) Auxiliary SCADA for control and monitoring of Auxiliary Power Supply;
- (2) DG Set to meet the Essential power supply at the station & depot as required and as described under
- (i) Lighting Load including Security Light and Signage;
 - (ii) Fire Detection and Alarm system / Suppression system as required;
 - (iii) Water Supply & Drainage Pumps;
 - (iv) Ventilation;
 - (v) Computers, Printers load;
 - (vi) SCADA System;
 - (vii) Access control system;
 - (viii) Signalling and Telecom Equipment; and
 - (ix) Other controls & Battery backup requirement.
- (3) UPS System to meet emergency Power requirements as described under :
- (i) Auxiliary SCADA System and associated equipment at the Station and Depot;
 - (ii) Very critical lighting
 - (iii) Small power sockets for computers at the station and Depot;
 - (iv) Access control System, Security Light and emergency signage;
 - (v) CCTV, intruder detection system at TSS and SSPs as required.
- (4) Provision of water pumps at Power supply installations viz. TSS and SSPs etc. to pump out the rain & storm water collected in trenches, Soak pits and sumps.
- (5) Automation of Water pumps for various bore wells constructed by CST contractor as per the application duty requirement;
- (6) Solar Power Systems as per the relevant chapters of this specification.

- (7) Earthing & Bonding and Lightning Protection System;
- (8) Ventilation and Air Conditioning system as per the relevant chapters of this specification,
- (9) Cold water dispenser with RO arrangement at the station and IMSD. The capacity and location shall be got approved from the Engineer;
- (10) Fire Detection and Alarm system as per the relevant chapters of this specification.
- (11) Fire Suppression and Portable fire extinguishers as per the relevant chapters of this specification.
- (12) Access control system as per the relevant chapters of this specification.
- (13) **Documentation:**
 - i. Operation & Maintenance (O&M) Manuals and other related Documentation;
 - ii. As Built Drawings and Documentation;
 - iii. Other documents as specified in relevant chapters;
- (14) Training for the Employer's personnel;
- (15) Furniture for OCC theatre as specified;
- (16) Miscellaneous items e.g. shock treatment charts, sectioning layouts, safety rubber mats, equipment number plates, first aid boxes and danger notice plates, fire buckets, etc., as required at substations and control rooms; and
- (17) Provide maintenance supervision support during Defect Notification Period;

3.2.2 The Electrical work inside different rooms of the station and depot building viz. Signalling & Telecom equipment rooms, Signalling & Telecom power supply equipment rooms, ASM/ Station Control/ Panel room, switch room, Battery Room, DG cum SOLAR room etc, shall be co-ordinated and interfaced as required with the CST Contractor (CP 302).

3.2.3 **Construction of Ancillary Buildings and Structures**

The Contractor shall undertake Design and Construction of following Ancillary buildings and structures guaranteeing at least minimum facilities as described herein but not limited to:

- (1) Auxiliary Substation (ASS) at Stations and Depot adjacent or subsidiary to the main buildings as required for Auxiliary Power Supply including HT / LT equipment Room, additional DG Room (in addition to the combined DG cum SOLAR room provided by CST contractor CP-302 at the station). An indicative plan of ASS is shown in Drawing No-GC/DFCC/ASS/506 included in Part – 4.
- (2) Control Room Buildings at Traction Sub-station (TSS), and Sub Sectioning & Paralleling Post (SSP);
- (3) Signal Equipment Rooms, Telecom Equipment Room and S&T Power Supply Equipment Rooms for Signalling and Telecommunication works in Block Section at Auto Location Huts, GSM-R locations and Interfacing IR Station as required and additional buildings, if any for Signalling and telecommunication works over and above the SER, TER and S&T Power Supply Equipment Rooms in Station and Block Section. An indicative plan of the S&T Equipment Room is shown Drawing No. DFCC/S&T/01/2016 and Drawing No. DFCC/S&T/02/2016 included in Part – 4.

- (4) TER shall preferably be co-located with SER and common S&T Power Supply Equipment Rooms, shall be constructed for housing Signalling Power Supply Equipment and Telecom Power Supply Equipment. If it is not possible to co-locate SER and TER, the size of independent Signalling Power Supply Equipment Room and Telecom Power Supply equipment shall be determined by the contractor in consultation with the Engineer during design stage to meet the requirements of General Specification and Particular Specification. An indicative plan of the Telecom Equipment Room & Telecom Power supply Equipment Room in such cases is shown in Drawing No. DFCC/S&T/02/2016. Included in Part – 4.
- (5) Structure / fencing as required for HV / LV transformers;
- (6) Structure/ fencing as required for Auto transformers(standalone post if any);

3.2.4 The General requirement for construction of the Control Room Building and Ancillary Building / rooms under the scope of the Contractor (CP-105) has been described in Chapter 17: Civil Work of this PS. The Contractor shall judiciously consider the location of Auxiliary substations as per requirement of Stations, Depots and other buildings etc. not exceeding the Voltage drop of 3%.

3.2.5 Arrangement of HT power supply point up to DFCCIL substation shall be carried out by the local Utility Agency. The Contractor shall be required to do liaising / pursuing with the local Utility agency as required ensuring timely completion of work and availability of Power supply. The Employer shall pay all the charges to the local Utility Agency as required.

3.3 E&M SCOPE FOR SERVICE BUILDINGS, ANCILLARY BUILDINGS AND STAFF QUARTERS

3.3.1 The work involved in this Bid is Design, Supply Construction, Installation, Testing & Commissioning of E&M and Associated Work. The Contractor shall undertake the scope of work and interface / coordinate with other designated contractor(s) including the information exchange for the activities as described hereunder :

Service Building	Activity by other Designated Contractor	Activity by CP-105
A. Service Buildings & Staff Quarters:		
1. Station Building (Junction Station)	Building construction, Drainage and plumbing including provision of concealed conduits for building electrification by the designated Contractor CST (CP-302).	<ul style="list-style-type: none"> - E&M and associated Works for Station building. - Fire Detection and Alarm System, - Portable Fire Extinguishers as per relevant chapter of this specification.
2. Depot (IMSD)	Building construction, Drainage and plumbing including provision of concealed conduits for building electrification by the designated Contractor CST (CP-302).	<ul style="list-style-type: none"> - E&M and associated Works for the Depot, - Fire Detection and Alarm System. - Portable Fire Extinguishers as per relevant Chapter of this specification.
3. DFCC Staff Quarter /	Building construction, Drainage and plumbing	- E&M and associated works.

Service Building	Activity by other Designated Contractor	Activity by CP-105
Residential Building	including concealed conduits for building electrification by other designated Contractor CST (CP-302).	
B. Ancillary Buildings & Rooms:		
4. Control Room Building for Traction substations and Switching Stations (i.e. TSS and SSPs etc.)	Only interface with CST (CP 302).	<ul style="list-style-type: none"> - Building construction, E&M and associated works Including drainage and plumbing, - Access Control. - Fire detection and Alarm System. - Fire Suppression system including portable fire extinguishers as required.
5. Auxiliary Substation for Auxiliary Power Supply, including HT/LT Equipment Room.	Only interface with CST (CP 302).	<ul style="list-style-type: none"> - Building construction, E&M and associated works Including drainage and plumbing, - Access control. - Fire Detection and Alarm System. - Fire Suppression system including portable fire extinguishers as required.
6. Additional DG Room	Only interface with CST (CP 302).	<ul style="list-style-type: none"> - Construction of rooms for DG Set including E&M and associated works at Station and depot as required. - Fire Detection and Alarm System. - Fire suppression system including portable fire extinguishers as required.
7. Signal Equipment Rooms, Telecom Equipment Room and S&T Power Supply Equipment Rooms for Signalling and Telecommunication works in Block Section at Auto Location Huts, GSM-R locations and Interfacing IR Station as required and additional buildings, if any for Signalling and telecommunicat	Only interface with CST (CP 302).	<ul style="list-style-type: none"> - Building construction, E&M and associated works Including drainage and plumbing - Provision of 230 V Aux AT Supply with Auto Source Transfer/ Automatic Change Over Switch. - Fire Detection & Alarm system. - Fire Suppression system including portable fire extinguishers as required.

Service Building	Activity by other Designated Contractor	Activity by CP-105
ion works over and above the SER, TER and S&T Power Supply Equipment Rooms in Station and Block Section.		
C: Services		
8. Solar Power Supply	Building and provision of Space by CST contractor(CP-302) as required	Solar panels of requisite capacity as specified including inverter, Auto Source transfer / Change over module as required and as specified in chapter 16 of this PS.
9. Water Pumping Automation	Construction of Bore well along with Water pump and Power panel by CST Contractor (CP-302).	Control & automation system (with level controlled automatic start & Automatic Stop) of Water Pump and arrangement of power supply by Contractor (CP-105).
10. Cold water dispenser with RO system	Provision water line, drainage and space for cold water dispenser with RO system by CST contractor (CP-302).	Provision of Cold Water dispenser with RO System at station and IMSD.
11. Fire Detection and Alarm System	- Provision of Concealed Conduits for Fire Detection and Alarm System at Station Building & Depot by CST Contractor (CP-302).	Provision of Fire Detection and Alarm system etc. as required and as specified in chapter 12 of this PS.
12. Ventilation and Air-conditioning System	Provisions in cut-out in walls of buildings constructed by CP 302 contractor, along with concealed conduiting, for air-conditioning equipment and fans.	Provision of Ventilation and Air-conditioning equipment etc. as required and as specified in chapter 15 of this PS.
13. Access Control System	Only interface with CST (CP 302).	Access Control System at Control room Buildings (TSS, SSP and SP etc.), Auxiliary Substation as required and as specified in chapter 19 of this PS.

3.4 INCIDENTAL WORKS

In addition to the above, the contractor shall undertake various incidental works to complete the entire project successfully. The contractor shall include the cost of such incidental works in the Bid. The incidental works shall include the Safety compliance and Interface Management.

(End of Chapter-3)

CHAPTER 4 - DESIGN CRITERION AND PROCEDURES

4.1 GENERAL DESIGN CRITERIA

4.1.1 Operational Requirements

- (1) The Permanent Works near running lines shall be designed to permit freight railway to operate satisfactorily at a maximum design speed of 100 Km/h for freight trains. The Contractor shall ensure that proposed size and location of permanent works and other contractor's works are free of infringement of the Maximum Moving Dimensions (MMD) of DFC as stipulated in Schedule of Dimensions (SSOD) of EDFC / Indian Railways.
- (2) In the design and construction of the Works, the Contractor shall, as a fundamental objective and as a priority, ensure that staff and the public will be provided with as safe an environment as is reasonably practicable throughout the execution period of the contract.
- (3) It is a requirement that the Indian Railway (IR) remains operational during the construction phase. No activity of the contractor shall infringe the Train operation in IR section during construction.

4.1.2 Durability and Maintenance

- (1) The Permanent Works shall be designed and constructed such that, they shall remain in a serviceable condition throughout their designed lives as described in the Design Criteria and standards contained in the Particular specifications to minimize the cost of operation and maintenance whilst not compromising safety or the performance characteristics of the railway.
- (2) Electrical and mechanical equipment where supplied shall be of a quality and durability, to fully meet the performance and operational requirements described in the Design Criteria.

4.1.3 Service Life

All equipment, cables and wiring shall be designed, manufactured and installed so as to secure a minimum service life as shown below:

- | | |
|-----------------------------------|---|
| (1) Main switchboards | 30 Years |
| (2) Transformers | 30 Years |
| (3) Sub-main switchboards | 30 Years |
| (4) Cables | 30 Years |
| (5) Fire alarm main panel | 30 Years |
| (6) Luminaires(excluding lamp) | 20 Years |
| (7) Tray, trunking and supports | 30 Years |
| (8) Lightning protection | 30 Years |
| (9) Sub-assemblies and components | 30 Years |
| (10) Earth Mat | 30years |
| (11) All other equipment | 20 Years |
| (12) Lamp life | as specified in relevant Chapter of this PS |

4.1.4 Proven Design

- (1) The Contractor shall develop the design based on the System Requirement Specifications (SRS) as compiled from PS and GS. The design shall be submitted with technical data / product catalogue, Design Validation calculations to the Engineer for review and approval.
- (2) The E&M System including its sub-systems and equipment shall be of proven design. The proposed System / Equipment to be used should be of proven performance of similar type, design and Capacity and should have been satisfactorily in use in adequate numbers/volumes (at least 70% of the estimated quantities) in Metros/ Railways/ Airports during last 3 years. The Contractor shall submit necessary proof in this regard.
- (3) Full & complete technical and operational details shall be included in the proposal submitted for approval for all major components together with full service history & performance details, number of units in use etc. & identities of users with addresses, telephone & fax. Number etc. for reference purpose.
- (4) Type test report/certificate is to be submitted. Fresh type test is to be carried out if the same has not been carried out.
 - a. In last three (3) years (prior to date of Second Stage Bid Opening or later);
 - b. Considering the Climate/environment conditions as specified in Chapter 2 of Volume-I, General Specification.
- (5) The Contractor shall provide mock-up models of the lighting/ fannage/ facilities proposed at various types of installations for approval so that these may be replicated.
- (6) Energy efficient fittings / fixtures of only reputed manufacturer shall be considered.
- (7) Where similar equipment or sub-systems of a different rating are already proven in service, then the design shall be based on such equipment of latest technology. Notwithstanding the fulfilment of the above stipulations, the Contractor shall furnish sufficient information as required by the Engineer to establish the energy efficiency and reliability of the offered sub-system.
- (8) The basic design shall conform to National Building Code, ECBC Code and NFPA.
- (9) The safety of installation shall comply with the provisions of the Indian Electricity Rule, IEEE-80 and IS standards.

4.1.5 Aesthetics

The Permanent Works shall be designed to achieve an aesthetic character and provide a feeling of design commonality throughout the project.

4.1.6 Safety, Health & Environmental Considerations

- (1) The design of the Permanent Works shall be according to Indian laws and regulations related to Safety, Health & Environmental Requirements.
- (2) Safety, Health & Environmental aspects shall be considered for the Design/Construction and Testing & Commissioning phase, requirement for which has been specified at appropriate places in the bidding document as well as in Part 2 Section VI, Volume 1, General Specifications, Chapter 2 for climate conditions and Chapter 9 for site Safety and Reference Document: Part -4 for Safety, Health and Environment. It shall be the overall responsibilities of the

Contractor to ensure compliance of Safety, Health & Environmental aspects at all times conforming to the provisions mentioned in this Bidding document.

4.1.7 Quality Control

Quality control aspects shall be considered during the Design/construction and testing & commissioning phase, requirement for which has been specified at appropriate places in the bidding document as well as in Part 2, Section VI, Volume 1, General Specifications, Chapter-11. It shall be the overall responsibilities of the Contractor to ensure deliverables of quality products at all times conforming to the provisions mentioned.

4.1.8 Tests

All the acceptance tests as per relevant Standards shall be carried out. The Contractor shall furnish the reports of all the type tests carried out. Tests shall conform to specification and relevant standard for all components / equipment / systems. These reports should be for the tests conducted on identical / similar components / equipment / systems to those offered / proposed to be supplied under this contract.

4.2 DESIGN CRITERION AND DESIGN REQUIREMENT

The requirements of Design procedures and processes during Design and Construction phases including those necessary for interface with various existing systems and agencies and those that are of general nature have been detailed in Part 2 Section VI, Volume 1, General Specifications- Chapter-6: DESIGN CRITERION AND DESIGN REQUIREMENT.

4.2.1 Basic Design Criteria & Performance Specification for Non Traction Power Supply

The design shall be evolved along with the following general principles:

- (1) Application of the latest code of practice and standards
- (2) Service proven design
- (3) Minimum life cycle cost
- (4) Low maintenance cost and easy of maintainability
- (5) Compact Design
- (6) Use of interchangeable, modular components
- (7) Extensive and prominent labelling of parts, cables and wires
- (8) Use of unique serial numbers for traceability of components
- (9) High reliability and availability
- (10) Low energy loss
- (11) System safety
- (12) Adequate redundancy in system
- (13) Use of fire retardant low smoke materials
- (14) Environment friendly
- (15) Adherence to operational performance requirements
- (16) Energy conservation features
- (17) Future expansion

Adequate margin shall be built into the design particularly to take care of the higher ambient temperatures, dusty conditions and high seasonal monsoon humidity, salinity

etc. prevailing in Northern India. The single point failure in the system shall not impact the performance of the system and shall be able to meet its application duty requirements without any compromise to performance or any intervention.

4.2.2 Project Data Parameters/ Performance requirement

(1) Power Supply System

- (a) The delivered LT electric power system shall be at 400 Volts, 3-phase, 50Hz, Four -wires, low voltage power distribution system.
- (b) 11kV /0.433 kV Electrical substation for 400 V supply and distribution shall be provided for the operation of the entire premises, 400V AC (3 phase) and 230V AC(Single phase) as required for buildings, for indoor and outdoor illumination, ventilation and air-conditioning and other associated works.
- (c) The electric substations shall be designed to feed the E&M power requirement of Station, Depot, Staff Quarters, and associated buildings. The contractor shall assess the power load requirement, Application Duty requirements keeping in view all electrical load of services envisaged at each location including future requirements if any (station, Depot etc.).
- (d) The incoming supply to the Sub-station load shall be double circuit, at 11kV for the station, Depot and staff quarters and associated buildings in DFC area through (dual) feeder.
- (e) Each Auxiliary Sub-station shall have 2 step down transformers of adequate capacity. The Contractor shall consider the Capacity of the 11kV/0.433kV Transformers and other power equipment suitable to meet the power requirement with minimum 20% future load requirement. One of the two transformers shall act as a standby and also be able to work in parallel, if required. The transformers at all stations shall have same rating.
- (f) All LT and HT Cables (up to 11kV): Cable laying work shall be buried / underground only.
- (g) Power cables shall be rated such that the maximum voltage drop from supply point to the farthest point of usage does not exceed 5% of the supply voltage under maximum loading conditions. The Supply feeder voltage drop shall be limited to 3%.
- (h) The Incomer cables for main, essential and emergency power shall be designed with 100% redundant Capacity.
- (i) All LT Panels shall be designed and installed with 20% spare feeders & switchgear and minimum of 15% spare space/ compartments to meet the future expansion needs by simple installation of switch gears.
- (j) All SDBs shall be designed with dual incomers with automatic source transfer with spare space similar to that of panels.
- (k) All Safety Systems, panel and Earthing shall use materials as per UL stipulations wherever applicable or as approved by the engineer.
- (l) All the HT & LT electrical panels shall have fire trace tube type extinguishing system to detect and extinguish the fire. Separate portable fire extinguishers shall also be provided as per requirement.
- (m) The HT and LT equipment of the sub-station shall be housed in a secure building or the station building and other specified buildings having adequate space, fully ventilated and weatherproof. The Transformers shall

be outdoor type placed adjacent to the building where substation is located and shall be securely fenced.

- (n) DG Set(s) with Auto Mains Failure (AMF) panel provided as standby Power to meet the Essential power requirement shall be of Silent type conforming to Central Pollution Control Board (CPCB) stipulations.
- (o) UPS (s) shall be provided to meet emergency power requirements.
- (p) Provision of Solar Photovoltaic (SPV) module array on the roof of the buildings complete with accessories for stations and other buildings etc. as specified in chapter 16.
- (q) An Indicative Scheme for Auxiliary power supply system is enclosed at Attachment –20.7.

4.2.3 Corrosion Protection

All ferrous components and fittings exposed to the atmosphere shall be hot-dip galvanized.

4.2.4 Acoustic Criteria

The material/ equipment used by the Contractor shall be suitably selected ensuring noise emission within the permissible limit as prescribed in the relevant international standards. The Guidelines of Central Pollution Control Board of India shall prevail.

4.2.5 Monitoring & Control

- (1) The work shall be carried out in accordance with the specifications and ensuring compliance with design and performance requirements as under:
 - (a) Order of priority for automatic changeover for S&T supply and Station load as needed;
 - (b) Auxiliary SCADA control for desired parameters (under chapter 10);
 - (c) Automatic Power Factor Correction Panel to achieve power factor of 0.95;
 - (d) All the equipment shall carry highest star rating for energy efficiency as prescribed by BEE as applicable;
 - (e) In Building Area, equipment shall be minimum of Ingress protection class of IP54 and on outdoor application shall be IP \geq 65;
 - (f) All meters shall be digital with RS 232/485 or equivalent port to facilitate connectivity with Auxiliary SCADA system and information exchange between Auxiliary and Traction SCADA.

4.2.6 Essential Power for Calculating Rating of DG Set

- (1) Power loads requirement as assessed by the Contractor shall include the power requirement of S&T installations as finalised and as approved by the Engineer.
- (2) Lighting including Security Light, critical Signage, Fire Detection and Alarm system /Fire Suppression system, Access Control System, Ventilation, Computers, Printers etc. at Station and Depot as applicable and all other installation included in the concept plan for Auxiliary power distribution system shall be connected to essential Power considering at least 30% of the total power load of the installation.
- (3) Indicative Power Supply Arrangement for S&T Installations / Other Installations is shown in Attachment–20.3 to this Specification. The contractor shall provide the Power supply with DG power back up for all S&T installations at the Station and Depot.

- (4) The Normal Auxiliary power supply shall be through the Aux. AT / Local Power supply and shall switch over to the DG / UPS backup in case outage of normal power supply. The Contractor shall provide automatic Source transfer system as readymade commercially available to prioritise the switching of power between Aux. ATs & Local, & Solar (base load) and finally to DG sets.

4.2.7 Emergency Power Requirement for Calculating Rating of UPS

- (1) UPS for Installations at OCC requirement shall be provided under CP 104, However Power requirement for Traction and Auxiliary SCADA system, its works station and associated equipment at OCC shall be interfaced with Contractor CP-104.
- (2) UPS System Installations at other than OCC: UPS power requirement as assessed by the Contractor shall include the power requirement as finalised and as approved by The Engineer.
- (3) Light including Security Light, critical Signage, small power sockets for computers, printers, at Station, Depot (IMSD) including Traction & Auxiliary SCADA load at Control Room Buildings (ASS,TSS and SSP), Access control system as approved by The Engineer.
- (4) The UPS Capacity shall include the power requirement of critical lighting load (at least 20% of the normal light load), including Access Control System, Fire detection & Alarm system, CCTV and small power socket for computers connected to UPS Power supply.
- (5) UPS shall be parallel redundant with minimum of 30 minute Battery power backup.
- (6) Indicative UPS Supply requirement is shown in Attachment – 20.2 to 20.4 to these Specifications.

4.2.8 Provision of all Electric Luminaires and Gadgets / Equipment

The Contractor shall provide all electric Luminaires and gadgets / equipment viz. ceiling fans, Cold water dispenser, window / split air-conditioners, exhaust fans, etc. as indicated in these requirements. Reference may also be made to **Attachment 20.1** to **Attachment 20.5** for these requirements. All outdoor Luminaires shall be of minimum IP65 class and indoor shall be of IP54 class.

Sl. No.	Parameter	Locations
1	Electric Luminaires and Ceiling Fans	In all buildings as required
2	Air-conditioning Requirement	Air conditioning of equipment room at Station and Depot etc. as required and as specified in chapter 15 of this PS.

4.2.9 Metering Equipment And Meter Box

Metering Requirements:

- (1) Gross domestic, street lights and operational energy demands should be metered separately.
- (2) Check Meters for Tariff purposes shall be provided at each receiving point of supply for different types of load similar to that provided by Power Supply Authority and as desired by the Engineer.
- (3) Where the Energy meters are provided for Residential Quarters, these shall have

digital energy meter which can exchange data from remote metering RF/GSM, of Class I accuracy and as per IS: 13779/99 (Latest Version) and IEC – 62056 DLM COSEM.

- (4) All major three phase outlets shall have meters which shall be used for measuring energy used and control function.
- (5) All energy meters shall be provided with RS232/485 or equivalent ports to exchange data through appropriate communication port and shall be able to be integrated with Monitoring Facility (SCADA) requirements as per control and monitoring parameter under chapter 10.

4.2.10 Name Plates and Identification

All parts of the installation, which are of relevance for its operation and maintenance, shall be provided with nameplates, tags or other markers/ arrows, especially in enclosed areas, such as ceiling, shafts, and other places accessible for maintenance service.

4.2.11 Colour Coding

Colour for power cables, bus bars shall be as follows:

Phase R	:	Red
Phase Y	:	Yellow
Phase B	:	Blue
Neutral	:	Black
Ground	:	Green or Green-Yellow Strip

At Junction boxes, wires and cables shall be colour coded with tapes/ferrule of specific colour for easy identification. Colour coding followed shall be as per the relevant standard and got approved from Engineer.

4.2.12 Packing and Marking

All materials and accessories shall be carefully packed for transport and storage on site in such a manner that they are protected against all climatic conditions, particular attention being paid to the condition prevailing on the site and shall comply with applicable standards and codes. All packed materials and accessories shall bear necessary information such as manufacturer's name, material name, type, rating/size/length, gross & net weight, packing interactions (i.e. fragile) etc. and shall be printed on the outside of the packing material.

4.3 CONTRACTOR'S RESPONSIBILITIES

4.3.1 The Particular Specifications have been prepared based on the Preliminary Concept Design. However, the Contractor shall review the concept, design and validate their design through simulations/ calculations and satisfy himself for adequacy for application duty & future requirement as identified and ensure that their proposed designs, capacities, ratings, specifications and quantities of equipment are sufficient to meet the functional, operational and performance requirements of the complete system in conformity with relevant standards and Good Industry Practices.

4.3.2 The Contractor shall be responsible for preparation and submission of Preliminary design, prepare detailed design, Calculation/validation & simulation for sizing of the equipment & system provisions, manufacture, supply, installation, testing and

- commissioning (including integrated testing and Commissioning), trial running, O&M manuals, training, as Built Drawings & Documentation, co-ordination and interface management with Other Contractors and other Contract obligations.
- 4.3.3 The Contractor shall be responsible for detailed design, layout, construction, manufacture, supply, installation, testing and commissioning of the buildings, structures and building services wherever applicable under this Contract.
- 4.3.4 The Contractor shall undertake that the designer shall be available to attend discussions with the Engineer and Employer at all reasonable times during the Contract period. The Designer shall be the same entity as proposed by the Contractor at the time of pre-qualification unless otherwise approved by the Employer.
- 4.3.5 The Contractor shall be fully responsible, for the suitability, adequacy, integrity, durability and practicality of the Contractor's proposal.
- 4.3.6 Wherever there is any inadequacy, insufficiency, impracticality or unsuitability in or of the Employer's Requirements or any part thereof, the Contractor's proposal shall take into account, address or rectify such inadequacy, insufficiency, impracticality or unsuitability.
- 4.3.7 The Contractor shall certify that:-
- (a) The Works have been or shall be designed, manufactured, installed, provided and otherwise constructed to the applicable standards available using proven up-to-date good practice.
 - (b) The Works shall, when completed, comply with enactments and regulations relevant to the Works.
 - (c) The design of the Works have taken or shall have taken full account of the effects of the intended manufacturing and installation methods, Temporary Works and Contractor's equipment.
- 4.3.8 The Contractor shall also provide an undertaking from the Designer for his design for suitability, adequacy, practicality and absolutely meeting the Employer's Requirements as detailed in Part 2, Section VI, Volume 1 - General Specifications, Chapter 15, Appendix 3: Design Certificate of Bidding Documents.
- 4.3.9 The work shall be carried out by the Contractor having valid Electrical Contractor License issued by the State Government for carrying out electrical installation work, by employing licensed supervisors and skilled workers having valid permits as per the Regulation of Indian Electricity Rules and Local Electrical Inspector's requirements.
- 4.3.10 Whether specifically mentioned or not in these Specifications, the work shall be deemed to include all the related minor works / items as appropriate including but not limited to hardware items, foundation bolts, termination lugs for electrical connections etc. as required and necessary for proper working of the equipment / system. If any activity of the work is considered to be essential for meeting the functional requirements of the equipment / system and satisfactory completion of the work but is not mentioned / specified herein or elsewhere in the Bid Documents, the same shall be deemed to be included in the Scope of Works and shall be executed by the Contractor. The work shall be handed over in a functional manner complete in all respect. All works are deemed to have been included unless quoted as deviation mentioned and modified / agreed by the employer explicitly if any.
- 4.3.11 All major equipment and materials namely Transformer, HT/LT Switchgear, Distribution / sub-distribution Boards, Switchboards, Feeder Pillar, Battery, DG sets, UPS, Battery Chargers, water pump automation, Luminaires with Electronic Chokes, fire detection and

alarm system, Access Control system, Solar system, ventilation and air-conditioning system etc shall be energy efficient and of higher star rating or as applicable as required for the work shall be subject to Quality Assurance Program as approved by the Engineer to ensure proper supply and use of raw materials, processes, installation / execution and tests.

4.4 SUBMISSION OF DRAWINGS AND DOCUMENTS

Contractor shall design and develop the documents and drawings for the E&M and civil work under the scope and shall submit but not limited to the following:

- (1) Inception report with methodology and implementation plan.
- (2) Implementation schedule.
- (3) Preliminary Design and Development of Concept Design Report (CDR).
- (4) System Requirement Specifications (SRS).
- (5) Scheme design as supported by Calculations, Report and sizing of equipment as validated through software.
- (6) Design document, calculations and drawing for Ancillary building structures of control room buildings, ASS, DG Room and structure, S&T installation in Block section and other ancillary rooms.
- (7) Foundation Layout Drawings for all installation/ buildings and equipment.
- (8) Outline Dimensions of all Equipment.
- (9) Equipment Room Layouts.
- (10) Architectural & structural drawings for Ancillary Buildings / control room building finishes (TSS & SSP), ASS, DG Room and structure, S&T installation in Block section and fencings, boundary wall, access/approach roads, architecture finishes, plumbing and drainage etc. as described in chapter 17: Civil Work.
- (11) Sub System / Equipment Detailed Design & Documents Report including the finalization of Load & Power requirement, calculations for sizing of equipment/cables, Cable Containment system, load flow analysis, Short circuit Analysis and voltage drop as validated through software and relay coordination for the entire power distribution system. All Designs and Design reports thereof shall be submitted for each calculation describing the assumptions, boundary conditions, method, evidence of such methods used by others, calculations, recommendations duly signed by the designer(s) in confirmation of having prepared, checked and issued.
- (12) Earthing & Bonding Scheme, Protection Study including design of earthing mat/stations and network, limiting the step and touch potential and associated drawings as supported by Calculations, report and validated through software.
- (13) lightning protection system as supported by Calculations, report and validated through software.
- (14) Indoor and outdoor lighting calculation as validated with calculations and the proven software.
- (15) Ventilation and air-conditioning system as supported by calculations report and validated through software for different installations and related construction reference drawing.

- (16) Inspection and Testing Protocol requirements.
- (17) Wiring Layout.
- (18) Protection scheme, Insulation and Relay coordination, Earthing and bonding schedule.
- (19) Fire detection scheme for different locations and details of deployment of sensors.
- (20) Fire suppression scheme and drawings.
- (21) Schematic drawing for Access control system.
- (22) Power supply, control and monitoring arrangement at Water Pumping installations.
- (23) Detailed Design Report.
- (24) Good for Construction Drawings.
- (25) Proposal of Makes of Equipment in the Format as prescribed by the Engineer in compliance to PS, SRS and performance, requirement, identifying MTBF, MTTR duly signed by the Contractor in confirmation of having proposed in conformance to PS, contract conditions and application duty requirement.
- (26) Product Catalogue and the General arrangement drawings.
- (27) Preparation of Technical Specification in compliance to PS, SRS and performance, requirement, Supportive Calculations, listing MTBF, MTTR, Methods of Measurement, Requirements of RAMS demonstration and Testing & Commissioning etc.
- (28) Shop Drawings.
- (29) As-built drawings and documents.
- (30) Operating and Maintenance Manuals.
- (31) Facility monitoring and their control parameters, mimic panel, diagnostic module and hard ware requirements.
- (32) Schedule for Approval of any first fix/installation including that of the lighting and fan arrangement.
- (33) Any other drawing and document as required for execution of work and as required by the Engineer.
- (34) Soft copies of all drawings should be submitted in DVD.

4.5 GENERAL DESIGN CRITERIA FOR SERVICE BUILDINGS AND OTHER STRUCTURES

- (1) All Ancillary Buildings viz. Control Room Buildings (TSS and SSPs), Signal Equipment Rooms, Telecom Equipment Room and S&T Power Supply Equipment Rooms for Signalling and Telecommunication works in Block Section at Auto Location Huts, GSM-R locations and Interfacing IR Station as required and additional buildings, if any for Signalling and telecommunication works over and above the SER, TER and S&T Power Supply Equipment Rooms in Station and Block Section, Auxiliary Substation (ASS), additional DG Room and structures as defined in scope of work shall be executed by the Contractor (CP-105). The layouts of Ancillary Buildings / rooms and structures as defined in the scope of work, shall be executed by the contractor (CP-105). The layout of Ancillary, Service and Residential Buildings are included as indicative reference drawings.

The contractor shall develop the layout, architectural plan and elevation and detailed design and drawings of various facilities as brought out in the relevant drawings. The General Arrangement drawings and layouts will be approved by Engineer and consented by employer.

- (2) Architecture and profile of buildings shall conform to local aesthetic, cultural ethos, etc. and it shall be approved by Engineer.
- (3) The foundations of buildings shall be designed for at least one story more than the requirement.
- (4) The site of the work shall be cleared off the shrubs, rank vegetation, grass, bushes and other materials upto adequate depth as required as per site condition and rubbish removed outside the periphery of the area being cleared.
- (5) The plinth level of Auxiliary Substations, Signal Equipment Rooms, Telecom Equipment Room and S&T Power Supply Equipment Rooms for Signalling and Telecommunication works in Block Section at Auto Location Huts, GSM-R locations and Interfacing IR Station as required and additional buildings, if any for Signalling and telecommunication works over and above the SER, TER and S&T Power Supply Equipment Rooms in Station and Block Section shall be at least 300mm above the Rail level. The Plinth level of Control room buildings like TSS, SSP in proximity of Railway alignment shall be 900mm above natural ground level or 600mm above Highest Flood Level (HFL) whichever is higher.
- (6) The enclosed area between the boundary walls / fencing for the buildings constructed by the Contractor shall then be filled with earth and well compacted by a suitable method as decided by the Engineer.
- (7) Chain link fencing shall be provided around TSS, SSP, Distribution Transformer and S&T Service Buildings in block section (Auto Location Huts) consisting of Signalling Equipment Rooms, Telecom Equipment Rooms, Signal & Telecom Power Supply Equipment Rooms, GSM-R equipment rooms; any additional Service buildings for S&T works in Station and Block section as per Drg No. GC/DFCC/CHAIN LINK FENCING/TYP-001. The distance of Chain Link Fencing from walls of SER, TER and S&T Power Supply Equipment Rooms shall generally be 1.5 meter or as decided by the Engineer during design stage.
- (8) The ceiling height of service buildings shall be minimum 4.2 m (including clear head room below beams if any) above floor level.
- (9) Construction of additional room for installation of DG Set at station building shall preferably be on extreme corner of building to keep vibrations and exhaust at one end.
- (10) The functional and structural design of service building shall conform to National building code and bye-laws of local authorities to the extent of their applicability. The method of structural analysed shall be appropriate for the structure or the component to be analysed and it shall be carried out by contractor using established software with the approval of Engineer.
- (11) Load due to earth quake (as applicable for the earth quake zone in which Service building falls) shall be assessed as per provisions of relevant IS Code with latest amendments/revisions.
- (12) Load and load combinations shall be for most unfavourable effects and shall comply with relevant Indian Standard with latest amendments.

- (13) The overall stability and serviceability requirement shall be checked in accordance with the provisions of relevant Indian Standard.
- (14) All buildings shall be amenable to maintenance with minimum efforts.
- (15) All buildings shall be provided with concealed ducts/pipes for wiring of telecom facilities in addition to wiring for power supply distribution and lighting as coordinated with other designated contractor.
- (16) Ducts shall be provided on floor for entry/exit of S&T cables and also for power supply cables.
- (17) Service Building signage shall be designed and provided.

4.6 EMPLOYER'S REQUIREMENTS - FUNCTIONAL

4.6.1 The contractor (CP-105) shall execute all E&M and associated works as described in the Scope of work and as required for following Buildings and Quarters constructed by other Designated Contractor CST (CP-302). The Contractor (CP-105) shall develop detailed design and drawings for E&M and associated works including those for combined services. The Contractor shall interface with other designated contractors and provide E&M services as required.

(1) JUNCTION STATION

- a. Junction station is the interchange stations with Indian Railways. There is only one Junction Station, namely New Boraki at chainage km 1411.370 in the section Dadri – Khurja.
- b. Indicative plan of Junction station is shown in Drawing No. GC/DFCC/JS/101/REV.1 included in Part – 4. Civil work of Junction Station is carried out by CST Contractor including concealed conduits in Contract Package 302. However Electrical works in these buildings are included in present scope of works of Contract Package 105.

(2) CROSSING STATIONS: NIL

(3) INTEGRATED MAINTENANCE SUB DEPOT (IMSD)

- a. It is proposed to construct one IMSD between Khurja and Dadri stations at New Boraki by the CST contractor (CP- 302). Civil work of IMSD is carried out by CST Contractor including concealed conduits in Contract Package 302. However electrical works in these buildings are included in present scope of work Contract Package 105.
- b. The indicative plan and elevation for IMSDs is as brought out in Drawing No. GC/DFCC/IMSD/401 included in Part -4.

(4) RESIDENTIAL QUARTERS FOR DFCC

It is proposed to construct two types viz type A and type B, of quarters by the CST contractor (CP-302). The indicative schematic plan for Type A and Type B, quarters shall be as per table below:

S. No.	Type of quarter	Reference to indicative Drawing (Appendix)/ Indicative area of the building	Number of Residential Quarters
1.	Type A	GC/DFCC/QTRS-701	48
2.	Type B	GC/DFCC/QTRS-702	07

Civil work of Residential Building is carried out by CST Contractor including concealed conduits in Contract Package 302. However electrical works in these buildings are included in present scope of work Contract Package 105.

(5) RESIDENTIAL QUARTERS FOR IR.

It is proposed to construct some residential quarters for Indian Railway staff, which work will be done under CST contract package CP-302. Civil work, complete electrification works including concealed wiring and power supply from nearest substation shall be carried out by the CST Contractor.

4.7 OPERATION CONTROL CENTRE (OCC) (constructed by other designated contractor of CP 104 of EDFC)

4.7.1 The Integrated Operation Control Centre (OCC) for the Eastern Dedicated freight corridor has been planned at Allahabad. The building construction and associated E&M work shall be executed by Designated Contractor under Contract Package 104 of EDFC. However, the provision of SCADA equipment and other associated works for Dadri-Khurja Section at OCC shall be under the Scope of the Contractor (CP-105), as described in relevant chapters of this PS.

4.7.2 OCC Arrangement and Features

- (1) A tentative plan, elevation section is given in Drawing No- GC/DFCC/OCC/601to608.
- (2) OCC (theatre) caters all the requirement and technology considered to monitor, control & management of train movement and all facilities required to enable it, while ensuring that personal manning the facility can easily access all available information to make decision as may be required.
- (3) For this purpose information shall be displayed on two systems one that is common to all and displayed on the video wall provided by the Contractor (CP-105), and the second through display monitor placed on the console/ Work station of each operator.
- (4) OCC layout has been designed by the Designated Contractor (CP 104) to provide un-obstructed view of the displays for all operators of OCC while providing adequate space for their consoles and movement. The floor shall be raised to accommodate all cables & to have view of all mimic panel. The theatre shall be acoustically designed with effective lighting. Horizontal & vertical ducts shall be provided for cables from ground floor to the theatre as per requirement of System Work and Transmission & Power Supply.

4.8 THE EQUIPMENT AND FACILITIES PROVIDED BY THE CONTRACTOR (CP-105) FOR AUXILIARY SCADA

4.8.1 The arrangement of OCC under CP 104 is described above. The Monitoring & Control Equipment considered for Dadri to Khurja Section shall be ergonomically designed and housed in the same OCC theatre. The arrangement of SCADA equipment of CP-105, Dadri to Khurja section shall preferably be similar to that of CP-104. The Contractor (CP-105) shall supply & install control and monitoring equipment at space earmarked in the OCC theatre for Traction Power SCADA system and Auxiliary power SCADA. The Contractor shall provide across the platform information exchange at OCC level between SCADA systems provided under CP-105 and between the SCADA systems provided

under CP-104 in adequate numbers and redundancy.

- 4.8.2 The Video wall for displaying the Traction SCADA system for the Dadri to Khurja section shall be provided by (CP – 105) Contractor.
- 4.8.3 All equipment shall be neatly arranged in demarcated place/ area and aligned as per the arrangement agreed by the Engineer. The requisite furniture satisfying the functional requirements of OCC theatre shall also be provided similar to that of CP-104. The Equipment, accessories and Furniture shall be designed to ensure that all items of furniture are able to perform their intended function and that there is no impediment to the opening of doors and drawers. Trunking and Cables should be concealed, however accessible for maintenance. Power sockets (connected through UPS power) are to be installed inside the cabinets in the rear of the work consoles. The number of sockets should be sufficient in numbers to supply all the related equipment (computers, monitors and other equipment) on each work console with inbuilt redundancy. Printers should be of the low noise type. Should this not be achievable, printers may be housed in cabinets with transparent tops and door to minimize noise.
- 4.8.4 The Work station and Consoles that house the equipment to provide the ability to monitor, supervise, communicate and direct all operations of the concerned section of EDFC line, shall be designed to minimize stress during all modes of operations by maintaining clear and open work areas with easily accessed equipment. The consoles shall be so situated as to maximize ease of control and simplification of line control. The work station and console shall be similar to the designs of similar equipment provided for CP-104 as indicated above to maintain uniformity in architecture, looks, aesthetics and operation.
- 4.8.5 The Control & Monitoring equipment provided by Contractor (CP-105) shall conform to the requirement of Electromagnetic Interference and Electromagnetic Compatibility and limit within the acceptable limits including that of acoustic level.

4.9 ANCILLARY BUILDINGS CONSTRUCTION

The contractor (CP- 105) shall execute the construction of all Ancillary Building including E&M and associated work as described hereunder:

- 4.9.1 Control Room at Traction Sub-Station: An indicative plan and elevation is shown in Drawing No-GC/DFCC/TSS/503. Plinth area of the layout proposed by the contractor shall not be less than the plinth area shown in the drawing.
- 4.9.2 Control Room at SSP: - An indicative plan and elevation is shown in Drawing No-GC/DFCC/ SSP/504. Plinth area of the layout proposed by the contractor shall not be less than the plinth area shown in the drawing.
- 4.9.3 Auxiliary Substation: - HL / LT Equipment Room and additional DG room at the station and depot: - An indicative plan is shown in Drawing No-GC/DFCC/ASS/506. Plinth area of the layout proposed by the contractor shall not be less than the plinth area shown in the drawing.
- 4.9.4 Signal Equipment Rooms, Telecom Equipment Room and S&T Power Supply Equipment Rooms for Signalling and Telecommunication works in Block Section at Auto Location Huts, GSM-R locations and Interfacing IR Station as required and additional buildings, if any for Signalling and telecommunication works over and above the SER, TER and S&T Power Supply Equipment Rooms in Station and Block Section. The indicative plan area for S&T Service Buildings in the block section (Auto Location Huts) is shown in Drawing No-DFCC/S&T/01/2016 & Drawing No.-DFCC/S&T/02/2016. Plinth of the layout

proposed by the contractor shall not be less than the plinth area shown in the drawing.

The drawings of these Equipment Rooms shall be submitted to the Engineer for approval. The list of drawings (indicative) is indicated below:

LISTS OF DRAWINGS (INCLUDED IN PART 4- REFERENCE DOCUMENTS)

Sr. No.	Drawing Names	Drawing Numbers
1.	Junction Station Building (Including Resting facilities)	Drawing No-GC/DFCC/JS/101/REV.1
2.	Integrated Maintenance Sub Depot	Drawing No-GC/DFCC/IMSD/401
3.	Control Room at Traction Sub-Station	Drawing No-GC/DFCC/TSS/503
4.	Plan of SSP	Drawing No-GC/DFCC/ SSP/504
5.	Auxiliary Substation and additional DG room at stations and depot	Drawing No-GC/DFCC/ASS/506
6.	Signal & Telecom Equipment Rooms	Drawing No- DFCC/S&T/01/2016 & Drawing No.-DFCC/S&T/02/2016.
7.	Offices & Operational control Centre (Not Applicable)	Drawing No-GC/DFCC/OCC/601-To-606
8.	Staff Quarters for DFCC	Drawings No-GC/DFCC/QRTS/701-To-703
9.	Chain link fencing	DFCC/CHAIN LINK FENCING/TYPE-001

(End of Chapter-4)

CHAPTER 5 - DISTRIBUTION TRANSFORMER

5.1 GENERAL

This section of the Specification covers the requirements of design, supply, manufacture, construction / installation, testing and commissioning of 11/0.433kV Outdoor Type Distribution transformer complete with all accessories for efficient and trouble-free operation.

5.2 SPECIFICATIONS

- (1) The Distribution Transformer shall be copper wound, oil cooled, Dyn 11 as per IS: 2026/IEC 60076 with latest amendments. The transformer shall be suitable for outdoor.
- (2) The Distribution Transformer shall be provided complete with accessories e.g. conservator, off load tap changer, silica gel breather, winding/oil temp indicators, explosion vent, rollers etc.
- (3) Transformer earthing shall be done as per relevant section of Indian Electricity Rule and IS 3043. This includes earthing of secondary neutral as well.

5.3 PERFORMANCE

Rise in temperature of transformer when tested at continuous maximum rating at a peak ambient temperature of 50°C, shall not exceed the limits given below:

- (1) For Windings - Average temperature rise as measured by increase in resistance of windings connected between terminals shall not exceed 40°C.
- (2) For Oil - Temperature rise as measured by thermometer in oil of the transformer shall not exceed 35 °C.
- (3) For cores - Temperature rise when measured by thermometer on the external surface of core shall not exceed the temperature permitted as per relevant IS.
- (4) The Distribution Transformer losses shall not exceed as per specified criteria of BEE for 5 Star rating or as applicable.

5.4 IMPULSE STRENGTH OF WINDINGS

The impulse strength of windings of the transformer shall meet the requirements of relevant IS. The transformer shall have fully insulated windings designed to meet impulse levels.

5.5 FREQUENCY

The transformer shall be designed for a rated frequency of 50 c/s and shall be capable of giving the rated output with the frequency varying by plus or minus 3% from the rated frequency.

5.6 EXTERNAL SHORT CIRCUITS

The transformer shall be designed to be capable of withstanding without injury, the

thermal and mechanical effects of short circuit at the terminals or any winding for the period in accordance with IS.

5.7 EFFICIENCY AND REGULATION

Efficiency and regulation shall be based on loading at rated KVA at unity power factor, 0.8 lagging power factor. The same shall be computed and assured in accordance with applicable Standards.

5.8 FOUNDATION AND FENCING FOR TRANSFORMER

A suitable foundation and fencing shall be provided by the Contractor as approved by the Engineer.

5.9 CLEARANCES

The electrical clearances shall be maintained as per Indian Electricity Acts/Rules and as indicated by the Supply Company. The design of the transformer shall be chosen /carried out considering the electrical clearances stipulated.

5.10 TYPE TEST AND ACCEPTANCE TEST

(1) The Contractor shall furnish the reports of all type tests carried out. Type test certificates to IS: 2026 (Part I) – 1977 (Latest Version) and a copy of the short circuit test conforming to IS: 2026 (Part I) – 1977 (Latest Version) successfully carried out on identical transformer shall be submitted to the Engineer without which transformer may not be considered for acceptance.

(2) Routine Tests – Tests as per IS: 2026 (Part I) – 1977 (Latest Version), shall be witnessed by the Engineer at the manufacturer's works.

(3) Noise

The audible sound level measured at one meter from the external surface of the transformer shall be as per NEMA standard.

(4) Testing at Site

Prior to commissioning of the transformer, the following tests shall be performed:

- (i) Insulation Resistance.
- (ii) Winding Resistance
- (iii) Dielectric Strength
- (iv) Input Power Supply
- (v) Output Voltage
- (vi) Ratio Test
- (vii) Phase Sequence Acceptance / Rejection Parameters

Sl. No.	Relevant IS Code and Clause No. (Latest Versions)	Acceptance limit	Rejection Limit
1.	IS : 2026 (Part I), Clause no. 4.3.1 (Operation other than rated voltage)	Limits within $\pm 10\%$ of rated voltage of particular tapping	Limits Exceeding $\pm 10\%$ of rated voltage of particular tapping
2.	IS : 2026 (Part II), Clause no. 3.2 (Temperature Rise)	Limits as specified in Clause no. 3.2 of IS : 2026 (Part II),	Exceeding limits as specified in Clause no. 3.2 of IS : 2026 (Part II),
3.	IS : 2026 (Part I), Table 3 (Impedance Voltage)	4.5% upto 630 kVA 5% above 630 kVA and upto including 1000 kVA	Exceeding limits 4.5% upto 630 kVA 5% above 630 kVA and upto including 1000 kVA
4.	IS : 2026 (Part I), Clause no. 8.1.6 (Tap Changing Equipment), IS : 10028 (part 1)	Limits as specified in Clause no. 3.2 of IS : 2026 (Part II),	Less than limits as specified in Clause no. 3.2 of IS : 2026 (Part II),
5.	IS : 2026 (Part I), Clause no. 9.1.3 (Duration of Symmetrical Short Circuit Current)	2 Seconds	Period less than 2 Seconds
6.	IS : 2026 (Part I), Table 7 (Tolerances)	As specified in Table 7 of IS: 2026	Limits exceeding as specified in Table 7 of IS: 2026

5.11 SAFETY ITEMS

Contractor shall assess the risks and hazards and take all the safety measures to mitigate the hazards. Safety items in the substation shall include the required type and number of the equipment as calculated from Design and Employer's Requirements and Concept Plan. The Sub-station and Panel Rooms shall be equipped with safety mats, safety charts, danger sign boards as per IE rules.

(End of Chapter- 5)

CHAPTER 6 – HT / LT SWITCHGEARS AND THEIR ENCLOSERS

6.1 HT SWITCHGEAR

6.1.1 General

This section of the Specifications covers the design, manufacture, type and routine tests and delivery of indoor HV Switchgear of 11kV rating and enclosure system. The type of breaker, fault level rating, etc. shall be as per specifications. The equipment to be offered under this specification shall be of Proven Design. Further, the switchgear must have been type tested in the same configuration that has been offered.

6.1.2 Construction

- (1) The switchgear unit shall be designed, manufactured and tested in accordance with relevant Indian Standard Specifications. The panels shall be indoor type, metal enclosed, Powder coated, with circuit breaker of fully draw out design. The insulators shall be made of high epoxy resin moulding. The bus bars and cable chambers shall be housed in separate chambers.

The bus bar chambers shall be fitted with bolted covers with gaskets and should be fixed to avoid direct access to live parts immediately after opening respective covers. The bus bars and jumper connections shall be insulated for maximum operating voltage. The design of the board shall permit further extension at both ends. The cubicle shall be designed for IP4Xprotection.

- (2) The HV Panel board shall be designed with at least 15% or at least one spare feeder in such a manner that the switchgear, instruments, relays, bus bars, small wiring, etc. are arranged & mounted with due consideration for the following:
 - (a) Facility for inspection, maintenance & repairs of testing terminals & terminal boards for ease of external connection
 - (b) Minimum noise & vibration
 - (c) Risk of accidental short circuits & open circuits
 - (d) Secured & vibration proof connections for power & control circuits
 - (e) Risk of accidental contact & danger to personnel due to live connections
 - (f) Mounting height shall be approachable and shall not be more than 1700mm from finish floor level
 - (g) Extendable in future
 - (h) PU foamed gaskets for doors (100% CFC free)
 - (i) Anti-condensation space heaters
 - (j) Epoxy resin type CT & PT with accuracy class as per relevant IS.
 - (k) SMF battery backup for tripping & auto reclosing of breakers
 - (l) Digital metering with RS 485 port for download and diagnostics
 - (m) Energy monitoring system on the incomers with Accuracy class-1
 - (n) Bus bars 100% electrolytic copper to DIN EN 13601

- (3) Enclosure shall be fabricated with CRCA sheet of minimum 2.0mm thickness.
- (4) Panel shall conform to IEC 62271-200, IEC 62271-1 and IEC 61439 connected sections.
- (5) Internal wiring shall be FRLS– XLPE.
- (6) Indicating lamps shall be Multiple LED type.
- (7) Breaker shall be VCB mounted on roll out track.
- (8) General arrangement shall be as per CPWD specification for Electrical Works Part-IV Sub-Station, 2007 as approved by the Engineer.
- (9) Bus bar support shall be insulated with coloured, heat/cold shrinkable PVC sleeves & shrouded joints.
- (10) The bus bars shall be amply sized to carry the rated continuous current under the specified ambient temperature without exceeding the total temperature of 85°C under load or fault conditions.
- (11) The bus bars and their connections shall be capable of withstanding, without damage, the thermal and mechanical effects of fault current equivalent to the short time rating of the switchgear.
- (12) Relay based protection shall be provided at HV and LV.
- (13) Painting
 - (a) All metal surfaces of panels, e.g. switchgears, switchboards, DB boards, etc. shall be thoroughly cleaned and degreased to remove mill scale, rust, grease and dirt. Fabricated structure shall be pickled and then rinsed to remove any trace of acid.
 - (b) Sheet treatment with nano-ceramic coating, electro-dip coated primer with textured Epoxy polyester.
 - (c) Colour shade of final paint shall be RAL 7032 (epoxy based). The finished panel shall be Powder Coated. Panel finish shall be free from imperfection like pin holes, orange peels, run off paint, etc. The vendor shall furnish painting procedure details along with the drawing submission. The minimum Powder coating thickness shall be 80 microns conforming to BIS-3618-R (2002).

6.1.3 Safety Shutter Devices

- (1) A set of metallic shutters shall be provided to cover each 3-phase group of stationary isolating contacts. Each set shall be capable of being individually operated and individually padlocked.
- (2) The shutter shall open automatically by a positive drive initiated by the movement of the circuit breaker.
- (3) The closing operation shall also be automatic the moment the breaker is withdrawn.
- (4) All shutters shall be effectively earthed.

6.1.4 Insulators

- (1) Insulators of moulded or resin bonded material shall have a durable, non-hygroscopic surface finishes having a high anti-tracking index.

- (2) Insulators shall be mounted on the switchgear structure such that there is no likelihood of their being mechanically over-stressed, during normal tightening of the mounting and bus bars, connection, etc.

6.1.5 Circuit Breaker General Requirements

- (1) The circuit breaker shall be capable of making and breaking the specified fault currents without straining or damaging any part of the switchgear. The circuit breaker shall be stored energy closing type, electrically operated with tripping mechanism.
- (2) It shall also be capable of closing on load without suffering undue mechanical deterioration. The maximum make-time shall also be not exceeded.
- (3) It shall not be possible for the moving contacts to move from the open position unless the spring is charged for completion of the closing operation.
- (4) Closing action of the circuit breaker shall compress the opening spring ready for tripping.
- (5) Means shall be provided for electrical and/ manual closing and tripping of breaker either from local mode or remote mode. Manual, tripping of circuit breakers, shall be adequately shrouded / protected to prevent inadvertent operation.
- (6) It shall not be possible to render the electrical tripping feature inoperative by any mechanical locking device.
- (7) The breaker operating mechanism shall be electrically and mechanically trip-free in all positions. The breaker should also be provided with both mechanical and electrical anti-pumping devices by inserting an auxiliary contactor.
- (8) The Breakers shall conform to the requirement of Mechanical endurance of 10000 operations and electrical Endurance, class E2 in terms of IEC 62271 and certified/ tested for number operations specified therein for number of operations at rated current and at the maximum breaking current.

6.1.6 Vacuum Circuit Breakers

- (1) They shall comprise of three separate, identical single pole interrupting units, operated through a common shaft by a sturdy operating mechanism. Breakers shall be suitable for switching transformer at rated load.
- (2) Uni-polar over-voltage at circuit breaker terminal shall not exceed two and a half times nominal peak line to neutral voltage of the system while switching ON/OFF at any load.

6.1.7 Protection Relay

- (1) The offered relays shall be multifunction numerical type, only the aux relays for lockout, transfer fault indication etc. can be electro-mechanical type:
 - (a) Relay shall be suitable for both 1A and 5A CT secondary current
 - (b) Relay shall be draw out type
 - (c) Relay shall have front RS232/ 485 ports for SCADA connectivity.
 - (d) The communication protocol shall be real time open protocol.
 - (e) Relay setting change.
 - (f) Relay Fault, Event & Disturbance recorder extraction.

6.1.8 Name Plates and Identification

Suitable anodized Aluminium name plate shall be provided on the switchboard and individual panels.

6.1.9 Cable Boxes / Cable Chamber

Cable boxes / cable chamber shall be suitable for the type and size of cable specified. The position of the cable boxes shall be such that the cables can be safely taken and the jointing carried out in a convenient and satisfactory manner. The cable termination arrangement for multiple cables shall permit connection and disconnection of individual cables without disturbing the other cables. Cable chamber shall be hinged door type.

6.2 LT SWITCHGEAR

6.2.1 Scope

- (1) This section of the Specifications covers the design, manufacture, type and routine tests, delivery and installation of indoor LT Switchgear, of voltage rating 400V complete with bus connections, incoming circuit breaker, tie & feeder circuit breakers, and bus bars for distributing power to a 400/230V, 3-phase, 50Hz, 4-wires, incorporating circuit breakers, bus bars, interconnections, metering, protection and earthing.
- (2) The Contractor shall design fabricate ,supply and install the main low voltage switchboard, distribution boards, capacitor bank having automatic Power Factor correction Panels and all other Lighting and Power Distribution Panels and its accessories as described or indicated on the Drawings and specified herein.

6.2.2 Construction Requirements

(1) General

- (a) The switchgear panel shall be designed, manufactured and tested in accordance with relevant Indian Standards. The panel shall be indoor, metal enclosed, single front and free standing type. All switch fuse, moulded case circuit breakers and air circuit breaker feeders shall be in fully compartmentalized fixed/draw out design. The sheet steel (CRCA) used for fabrication shall be of minimum 1.6 mm for non-load bearing member and minimum 2.0mm for load bearing members. The panel shall be supplied with required base channels. The insulators shall be made of high epoxy resin moulding. The bus bars and cable chambers shall be housed in separate chambers.
- (b) The bus bar and cable chambers should be suitably shrouded to avoid direct access to live parts immediately after opening respective covers. The bus bars and jumper connections shall be insulated to full maximum operating voltage. The cubicle shall be designed for IP 42 protection. The bus bars and connectors shall be made of high conductivity copper. The bus bars shall be amply sized to carry the rated continuous current under the specified ambient temperature without exceeding the total temperature of 85°C (maximum temperature rise by 35 degree C). Unless otherwise stated, the entire bus bar shall be rated for the continuous rated current of the incomer. When sectionalized with a bus coupler, both the bus bars shall be of the full load rating.
- (c) Outgoing feeders shall have energy monitoring facility.

- (d) ACB (Draw out type) as incomers with remote access features.
- (e) MCCB/for outgoing feeders. Separate compartments for functional units.
- (f) Elect./Mech. interlocking between ACBs.
- (g) Enclosure construction with single sheet sturdy frame construction (As per IS 14772). Sheet treatment with Alu-zinc coating, for front doors, rear covers and side sheets. Inside partition chambers shall have electro-dip coated primer with textured Epoxy polyester. Powder coating thickness shall be as specified in BIS-3618-R (2002).
- (h) Doors shall be flush type, 1.6 mm minimum CRCA sheet thickness, Screw fastened hinges with Minimum 130 degree opening angle. Cam lock with double bit insert as per DIN 43668. Separate doors for each compartment duly interlocked with the breaker/MCCB in "ON" & "OFF" position.
- (i) Sealing gasket shall be tri-functional CFC free polyurethane gasket with temperature withstand range of -40deg to 90 deg. Non-hygroscopic in nature. Gasket should conform to DIN EN ISO 1856 & 1798 & compressive strength of 5 kPa as per DIN 53 577, tensile strength upto 2 MPa as per DIN 53 504.

(2) Safety Shutter Device

Shutters shall be provided at bus bar chamber cut-out for closing the same when the withdrawal chassis of the modules are drawn out. The bus bar shutters shall be automatically operated by the movement of the carriage.

(3) Insulators

Insulators of moulded or resin bonded material shall have a durable, non-hygroscopic surface finish having a high anti-tracking index as per IEC-112 standard. Insulators, barriers made out of synthetic resin bonded paper and treated wood shall not be accepted.

(4) Fast Bus Changeover

Automatic Fast changeover scheme between incomers and the tie shall be provided to close when incomer trips are initiated. The signal shall be given to the bus tie closing coil and incomer breaker tripping time and bus tie breaker closing time shall be around 20 millisecond. The closing of the bus couplers shall be done through synchro-check relays. The synchro-check relay shall be supplied from the secondary of the two (2) Bus PTs. This dedicated synchro-check relay shall be located on the switchgear. The transfer shall be blocked in case of fault in switchgear bus.

6.2.3 LT Air Circuit Breakers

(1) General

- (a) The breaker shall comply with the isolation function requirement of IEC 60 947-2 section 7.12 to marked as suitable for isolation / disconnection to facilitate safety of operating personal while the breaker is in use. The ultimate breaking capacity (Icu) shall be equal to Service breaking capacity (Ics) and Short Ckt Withstand capacity (Ics=Icu=Icw=100% for 1 sec. ACB should have single frame size up to 3200A and shall be suitable for "Switch Disconnect" function (AC 23 utilization category).The impulse withstand (Uimp) should be 12 KV.

- (b) The breaker shall provide protection class II insulation between the front panel and internal power circuits to avoid any accidental contact with the live main current carrying path with the front cover open.

(2) Constructional Features

- (a) The ACB shall be 4 pole as per application duty requirement with compact modular construction and moulded Housing, draw out, manually or electrically operated version as specified and shall be capable of providing short circuit, overload and earth fault protection through micro-processor based unit.
- (b) The Circuit Breaker cradle shall be designed and constructed to permit smooth withdrawal and insertion. The movement shall be free of jerks, easy to operate and positive.
- (c) Four pole ACBs shall have 4th pole protection adjustable at site as per size of neutral conductor i.e. Half neutral/full neutral/no protection.
- (d) All current carrying parts in the breaker shall be silver plated and suitable arcing contacts (with low per pole energy loss) shall be provided to protect the main contacts which shall be separate from the main contacts and easily replaceable. In addition, Arc chutes shall be provided for each pole, and these shall be suitable for being lifted out for the inspection of the main and the arcing contacts.
- (e) The circuit breaker shall have indication of mechanical wear of contacts enabling visible indication of contact life.
- (f) Self-aligning cluster type isolating contacts shall be provided for the Circuit Breaker, with automatically operated shutters to screen live cluster contacts when the Breaker is withdrawn from the cubicle. Sliding connections including those for the auxiliary contacts and control wiring shall also be of the self-aligning type. The fixed portion of the sliding connections shall have easy access for maintenance purposes.
- (g) All ACB's control wiring shall be accessible from the front along with all accessories, shunt closing, under voltage releases shall also be fit table from front.
- (h) There shall be flexibility in changing the types of terminals at site to suit the bus bar orientation if required.
- (i) The cubicle for housing the Breaker shall be free standing dead front pattern, fabricated from the best quality sheet steel.

(3) Operating Mechanism

- (a) The Circuit Breaker shall be trip free with independent manual spring operated or motor wound spring operated mechanism as specified and with mechanical ON/OFF indication. The operating mechanism shall be such that the circuit breaker is at all times free to open immediately the trip coil is energized. The breaker shall be provided with in built anti-pumping mechanism.
- (b) The closing time shall be less than or equal to 10 mill-sec to ensure faster closing of the breaker.
- (c) The operating handle and mechanical trip push button shall be at the front

and integrated with the Circuit Breaker.

- (d) There shall be mechanical indicator on the front panel for 'Ready to close' situation for the breaker by checking all interlocking.
- (e) The Circuit Breaker shall have the following four distinct and separate positions which shall be indicated on the face of the panel.
 - (i) "Service" -- Both main and secondary isolating contacts closed
 - (ii) "Test" -- Main isolating contacts open and secondary isolating contacts closed
 - (iii) "Isolated" -- Both main and secondary isolating contacts open
 - (iv) "Maintenance" -- Circuit Breaker fully outside the panel ready for maintenance

(4) Protections

- (a) The Microprocessor Releases unit shall be provided on circuit breaker for Long Time (Over load), Short Time (Short circuit) and Earth fault protection all with continuously adjustable setting and adjustable time delay by dial. Release shall also have Instantaneous Protection, True RMS sensing with EMC/EMI Compatibility. Microprocessor releases shall also have 1st ON/OFF time delay protection for short circuit and Earth fault.
- (b) Display - All breakers Releases shall have a LCD display of currents of all the phases (I_1 , I_2 , I_3) and Neutral. It shall also have Bar Graph to indicate individual phase loading and identify whether all phases are evenly loaded. All breakers shall be provided with a communicating port (RS 485/232) to the Microprocessor based releases without changing the releases. The releases shall have indications through LED's for Over load, short circuit and earth faults for fault differential and fault diagnosis ACB release should be provided with Rotary Dial and navigation Keys (both) for release setting. Release should be provided with Over Load Alarm LED.
- (c) Zone Selective Interlocking – The releases shall be suitable for communication between breakers to enable zone selective interlocking. This feature shall be provided continuously adjustable setting for both short circuit and ground fault protection zones to offer intelligent discrimination between breakers. This feature enables faster clearance of fault conditions, thereby reducing the thermal and dynamic stress produced during fault conditions and thus minimizes the damage to the system. The fault under the zone of lower stream should not trip the upstream breaker maintaining adequate discrimination.

(5) Circuit Breaker Interlocking

- (a) Sequence type strain free interlocks shall be provided to ensure the following:
 - (i) It shall not be possible for the Breaker to be withdrawn from the cubicle when in the "ON" position. To achieve this, suitable mechanism shall be provided to lock the Breaker in the tripped position before the Breaker is isolated.
 - (ii) It shall not be possible for the Breaker to be switched "ON" until it is either in the fully inserted position or, for testing purposes, it is in the

fully isolated position.

- (iii) It shall not be possible for the Circuit Breaker to be plugged in unless it is in the OFF position. ACB's Shunt and closing coils shall be continuous Duty cycle.
- (b) A safety latch shall be provided to ensure that the movement of the Breaker, as it is withdrawn, is checked before it is completely out of the cubicle, thus preventing its accidental fall due its weight.
- (c) Mechanical and electrical anti-pumping devices shall be incorporated in the ACB's as required.

(6) Circuit Breaker Auxiliary Contacts

The Circuit Breaker shall have suitable free / minimum 6 NO/NC auxiliary contacts rated at 16 amps 400 volts 50 Hz. These contacts shall be approachable from the front for connecting all external wiring from the front. They shall close before the main contacts when the Circuit Breaker is plugged in and vice versa when the Circuit Breaker is Drawn Out of the cubicle.

(7) Earthing

The frame of the Circuit Breaker shall be positively earthed when the Circuit Breaker is racked into the cubicle.

- (8) ACBs shall be provided with RS 232/485 ports for SCADA (Auxiliary Power supply) connectivity.

6.2.4 Moulded Case Circuit Breakers

(1) General

- (a) The circuit breakers shall comply with the requirement of IEC 60947 / IS 13947: 1993. MCCBs shall be suitable for nominal voltage of 3/4 phase 400 volts.
- (b) The circuit breaker shall comply with the isolation function requirement of IEC 60 947-2 section 7.1.2 to marked as suitable for isolation / disconnection to facilitate safety of operating personnel while the breaker is in use.
- (c) The circuit breaker shall provide protection class II insulation between the front cover and internal power circuits to avoid any accidental contact with the live moan current carrying path with the front cover open.
- (d) The breaking capacity of MCCBs shall be as per design requirements.

(2) Constructional features

- (a) The MCCBs shall be made of halogen free high strength heat resisting and flame retardant thermo setting insulating material.
- (b) Three phase MCCBs shall have a common handle for simultaneous operation and tripping of all the three phases.
- (c) The contact tips shall be made of suitable arc resistant sintered alloy. Terminals shall be of liberal design with adequate clearances.
- (d) Suitable arc extinguishing devices shall be provided for each contact.
- (e) MCCB rated upto 250 A shall have Thermal Magnetic release (Variable O/L

& Fixed S/C) and MCCB > 250 A should have Microprocessor based release with variable O/L & S/C settings.

- (f) MCCB's releases shall have true RMS Sensing and thermal memory.
- (g) Wherever MCCB's are required with earth fault protections, it shall be inbuilt in the electronic release with continuously adjustable current and time delays in overload, short circuit and earth fault or for lower faults add-on module (with adjustable settings of current and time) shall be provided which shall be direct acting on MCCBs.
- (h) MCCB release shall be EMI/EMC compatible.
- (i) There should be total discrimination between ACB's and MCCB's and between MCCB's upto the breaking capacity level of downstream device. Total discrimination shall be supported by selection charts for various combinations along with recognized Authority test certificates.

(3) Operating mechanism

- (a) The operating handle of the MCCBs shall be quick make / break, trip free type.
- (b) Fault differentiation should be there for O/L, S/C and E/F through individual LED.
- (c) The operating handle of the MCCBs shall have suitable, ON, OFF and TRIPPED indicators.
- (d) The operating handle and mechanical trip push button shall be at the front and integral with the circuit breaker.
- (e) MCCBs shall be capable of limiting the fault currents. The maximum thermal I^2t shall be indicated by the manufacturer. These characteristics shall allow high cascading performance with MCCBs / MCBs downstream.
- (f) MCCBs shall comprise of the mechanism designed to trip the circuit breaker in the event of high value short circuit currents.
- (g) The communication protocol shall be real time Open Protocol for SCADA / BMS connectivity shall be ensured.

(4) Circuit Breaker Interlocking

MCCBs shall be provided with following interlocking devices:

- (a) Handle interlock to prevent unnecessary manipulations of the breaker.
- (b) Door interlock to prevent door being opened when the breaker is in ON position.

(5) Circuit breaker auxiliaries

The circuit breaker shall be provided with following accessories, if specified in drawings/schedule of quantities:

- (a) Under voltage trip
- (b) Shunt trip
- (c) Alarm switch
- (d) Auxiliary switch

These Auxiliaries shall be common and shall be continuously rated for entire range of MCCBs.

6.2.5 Miniature Circuit Breakers (MCB)

Miniature circuit breakers used shall conform to IS: IS/IEC: 60898, 2002 or latest. The miniature circuit breaker shall be quick make and break type for 230/400V AC, 50 HZ application with magnetic & thermal release for over current and short circuit protection. The breaking capacity of MCBs shall not be less than 10KA at 400V AC. MCBs shall be DIN Rail mounted. The MCB shall be current limiting type (Class-3). MCBs shall be of Utilization Category (B, C, D ref. IS Standard) as the application duty requirement and per their Tripping Characteristic curves defined by the manufacturer. MCB shall have a minimum life expectancy of 20,000 operations.

6.2.6 Earth Leakage Circuit Breaker (ELCB)

ELCB/RCCB shall be current operated independent of the line voltage, current sensitivity of a -30 mA at 230/400 volts AC and shall have a minimum of 20,000 electrical operations.

6.2.7 Neutral Advance Features

The neutral moving contacts shall be so mounted on the common bridge that, at the time of closing, the neutral shall make contact first before the phases, and at the time of opening, the neutral shall break last after allowing the phases to open first.

6.2.8 Current Transformers

All current transformers shall be cast resin dry type and shall have insulation level and short time rating compatible with main switchgear. All current transformers shall be dimensioned to carry continuously a current of 120% of the rated current. The ratio adopted shall be as per design requirement. Accuracy class for metering CT's shall be 0.2 and for protection CT's 5P10 as per EN60044-1.

6.2.9 Voltage/Potential Transformer

- (1) All Voltage transformers shall be Cast Resin Dry type.
- (2) The Voltage transformer shall be insulated for full voltage wiring.
- (3) PTs used shall be capable of withstanding thermal and mechanical stresses resulting from short circuits, transient over voltages and anticipated surges.

6.2.10 Meters, Relays and Other Accessories

- (1) All relays shall be of switchboard pattern, back connected, draw out type suitable for flush mounting and fitted with dust tight cases and provided with flag indicators and manual reset devices. The relay shall conform to relevant specifications. The rating of the auxiliary contacts shall not be less than 10A at 230V AC and 5A for 110V DC.
- (2) Each incomer / feeder shall be equipped with relays. The complete protection scheme shall be submitted for Engineer's approval.
- (3) All relays shall have the following features:
 - (a) Shall be suitable for auxiliary supply, as per design requirement.
 - (b) Shall be of draw out type suitable for flush mounting.
 - (c) All auxiliary relays shall be of semi-flush or surface mounting.

6.2.11 Indicating Lamps / Push Buttons

- (1) These shall be switchboard type, low power consumption, long life LED cluster type lamps complete with necessary accessories. Lamps shall be provided with screwed translucent covers to diffuse light. The lamp covers shall preferably be unbreakable, moulded, heat resistant material and shall be provided with chromium plated bezels.
- (2) Push buttons shall be heavy duty, push to actuate type with coloured button and inscription marked with its function. Each push button shall have contacts as required, rated 10A at operating voltage.
- (3) Push button shall be shrouded type except for emergency trip button (if provided) which shall be mushroom type for easy identification. Push button colour shall be as follows:

Stop/Off and Emergency	-	Red
Start/On	-	Green
Reset	-	Black
Test	-	Yellow
Accept/Acknowledge	-	Blue

6.2.12 Control Switches / Selector Switches

- (1) Control and meter selection switches shall have integral nameplate and for all other devices, the same shall be located below the respective devices. Instrument and devices mounted on the face of the panels shall also be identified on the rear with the same number.
- (2) All control switches shall be rotary, back connected type. Phosphor bronze contacts shall be used on switches.
- (3) Control switch for incomer panels shall have one set of lost-motion spare contacts.
- (4) Ammeter selector switches shall be off position and with make before break feature and shall have 3 positions to read the three phase currents. Voltmeter selector switches shall also be of 3 positions and off position, suitable to read phase to phase voltages.

6.2.13 Control Fuses

All control fuses shall be of HRC link type conforming to IS: 13703. All fuses and links shall be provided with suitable identification labels.

6.2.14 Control Wiring

- (1) All wires carried within the switchgear enclosure shall be FRLS-XLPE insulated and neatly arranged so as to be readily accessible and to be easily replaceable. Wherever necessary, the wires should be run in cable trough and the wiring should be routed so that the same remains away from areas where electric flame or flash over may occur. No conduit or cables shall be carried through the bus bar chamber. All cable runners shall be insulated.
- (2) The Potential transformer wiring shall be done by FRLS-XLPE insulated, 1100V grade multi stranded flexible copper conductor of size 1.5 sq. mm. and all the current transformer and DC control wiring shall be of the same type of cables as specified above with conductor size of 2.5 sq. mm. The colour coding shall be as per IS: 5578 / 11353.

(3) 20% of extra spare terminals shall be provided. All terminals shall be suitable for terminating 2 wires from bottom and top side of the terminal block. However, not more than one wire shall be terminated from either side on any terminal.

(4) **Name Plate and Identification**

Durable name plates shall be provided on all the switchboards and individual compartments.

(5) **Earthing**

An earth bus of requisite section shall be provided. It shall extend throughout and solidly connect all panels in line with proper terminals, at the end to connect to the earth grid of the buildings. The terminal arrangement at the ends shall be suitable for connection to Earth flat and shall be complete with bimetallic washers, etc. No single point failure shall result in to the loss of earth continuity.

6.2.15 Lighting and Power Distribution Boards

(1) **Scope**

The scope of work includes design, manufacture, supply and installation, testing and commissioning of Lighting and Power Distribution Board as per the requirement in this section of Specifications.

(2) **General Requirement**

(a) The Distribution Boards and MCBs shall conform to IS: 13032 (Latest Version) and IS: 8623 (Latest Version). It shall be fabricated with minimum 1.6mm sheet steel complete with tinned copper bus bar, neutral bus bar, earth bus bar, detachable gland plat on top and on bottom, phosphatized and powder coated including earthing. It shall have a degree of protection not less than IP 54.

(b) The distribution boards shall serve the distribution of electrical power to lighting system, socket outlets, machinery/motors, etc. The loads shall be connected either directly to these boards or via sub-distribution boards.

(c) Each distribution boards shall be provided with 25% spare breakers (of each frame size). The overall rating, incoming cable and upstream provision shall be such that a 20% load increase for future expansion can be accommodated without alteration to the distribution system.

(d) The following colour coding shall be used for identification of bus-bars and wiring, as per Standards:

R-Phase	:	Red
Y-Phase	:	Yellow
B-Phase	:	Blue
N-Phase	:	Black
E-Earthing	:	Green or Yellow-Green
C-Control	:	Grey

(e) Removable gland plates shall be provided for top/bottom cable entry, as specified.

(f) An earth bus of aluminium strip of adequate section shall be provided all along the length of the panel with two bolted type earthing terminals. All metallic non-current carrying parts including doors, switch base, handles,

etc. shall be securely connected to the main earth bus by stranded PVC insulated copper wire with adequate size.

- (g) Danger plate shall be provided on each board as per relevant Standards.
- (h) Detachable end plates.
- (i) Switchgear accessories and connectors [Electrolytic copper for MCB connection with plastic insulation conforming to relevant standards.
- (j) LED phase indications.
- (k) Incomer suitable for 4-pole MCB/RCCB.
- (l) Din rail mounting for MCB's.
- (m) Fire retardant terminal block.
- (n) Knock out holes at top & bottom.
- (o) Reversible door arrangement.
- (p) Internal wiring FRLS, colour coding, terminal shrouds. Cover plate.
- (q) All terminations shall be done by using ferrules by crimping and no strands shall be cut.

(3) Bus-bars

The bus-bar and connectors shall be made of high conductivity copper. The bus-bar shall be amply sized to carry the rated continuous current under the specified/designed ambient temperature (50°C) without exceeding the total temperature of 85°C i.e. the bus bar temperature rise shall not exceed 35°C at full load condition. The bus-bar and their connection shall be capable of withstanding without damage the thermal and mechanical stresses of through fault currents. Contractor shall submit a calculation on withstand capacity and demonstrate the temperature rise within the limit.

6.2.16 Sub-Distribution Board Requirements shall include as under:

- (1) Enclosure of CRCA sheet not less than 2.0 mm thickness for load bearing member & 1.6 mm for doors.
- (2) Screw fastened hinges with minimum 130 degree opening angle. Cam lock with double bit insert as per DIN 43668.
- (3) Dual incomer facility with electrical & mechanical interlocking.
- (4) IP 54 protection.
- (5) Terminal blocks having fire retardant & unbreakable characteristics. Polyamide material. Mounting shall be Din or G-rail type.
- (6) MCCB with over current & earth fault microprocessor release.
- (7) LED indications: multi LED, with colours as per the application duty requirement or as approved by the engineer.
- (8) Sheet treatment with nano-ceramic coating, electro-dip coated primer with textured polyester. Coating thickness 80-135 microns. Shade RAL 7032.
- (9) CFC free polyurethane sealing gasket.
- (10) Earthing strip of 2x20mmx3mm GI strip or higher as per the application duty

requirement.

- (11) Overall height max 2300mm & operating handle not more than 1700 mm high in conformance to NEC.
- (12) Din rail channel for MCB mounting.
- (13) MCB as per IS/IEC 60898 with Minimum life expectancy 20000 operations.
- (14) Bus Bars of electrolytic copper to DIN EN 13601 & DIN 4376. Current density of bus bar 1.4 A/sq. mm. (temp rise of 30 deg celcius over ambient). The contractor may be required to demonstrate the conductivity level of the copper used.

6.2.17 Loose Wire Box

- (1) Loose wire box shall be provided in residential / building's wiring installation above / below sub-distribution board (SDB), etc. for accommodating loose wires / cables and / or incoming and outgoing conduits.
- (2) Loose wire box shall be fabricated with minimum 1.2mm thick CRCA sheet, duly powder coated of approved shade. Size and front cover of loose wire box shall match with the SDB, etc. subject to that its length, depth and height shall not be less than 125mm.
- (3) Loose wire box shall also be provided with detachable gland plates on top and bottom with knock outs and earthing terminal etc. as required.

6.2.18 LT Feeder Pillar

Feeder pillars shall be complete with MCCBs for incoming circuits, MCBs for outgoing circuits, time switch control of street light and pump, contactors and LED type indication lights. The numbers of each item shall be as required and approved by the Engineer. Feeder Pillar construction should be similar to that described for LT switchgear except that these shall be suitable for outdoor application and conform to IP 65 as per IEC 60529 . Top of feeder pillar shall be sloping, terminating in a cowl for easy drainage. The treatment of the metal part shall be as described elsewhere.

Work of installation shall be in conformity with IS: 10118 (Part III) - 1982 (latest version).

6.2.19 Automatic Power Factor Correction Panel

APFC panel shall consist of capacitors suitable for the peak load and the extent of improvement required viz. correction should give p.f. of at least 0.95 to avoid penalties. APFC Relay shall regulate capacitor banks in the circuit to achieve this. The breakup of capacitor banks shall be 5 KVAR, 10 KVAR, 25KVAR, 50 KVAR and 100 KVAR as per Capacitor duty application to be able to achieve fine control. APFC relay shall have a minimum of 12 port of selection.

(1) General

Capacitor banks are intended for supplying compensating leading VARs, thereby improving the overall power factor of the substation. Capacitor units shall be mounted inside the APFC panel, in separate cubicles.

APFC panels with detuned filters complete with necessary controls, protection and accessories as per the specific requirements shall be supplied.

(2) Design and Construction Requirements

- (a) Capacitor banks shall be of self-supporting, self-healing type conforming to IS: 13340 - 1993, 13341- 1992 & 13925 – 1998, floor mounting type APFC

panel with degree of protection of enclosure IP54 as per relevant standard. The Panel enclosure of CRCA sheet steel shall not be less than 2mm thickness. Control and protection elements for 400V capacitor banks shall be mounted on capacitor bank panel itself.

- (b) Main earth bus shall be run at the bottom of panel. Each capacitor unit body shall be connected to the Main earth by means of Copper Wire. All metallic supports shall be earthed.
- (c) All instruments and relays (PFCR) shall be neatly arranged on the front side and shall be flush mounted.
- (d) The Contractor shall design / select the required component conforming to Indian standards to make the system complete.
- (e) The panel shall be provided with two earthing terminals, undrilled cable gland plate, space heater and cubicle illumination lamp.
- (f) Both manual and automatic control of power factor correction shall be provided. Auto / manual selector switch for the above shall be provided on capacitor control panel.
- (g) The following power supplies shall be made available to the panel by the Contractor:
 - (i) 230V, 1 phase (for panel space heater and panel illumination).
 - (ii) The control supply shall be tapped from main incomer supply.
- (h) The system shall be provided with automatic power factor control, employing relay. It shall be a microprocessor based static unit with output relays equal to the no. of capacitor steps. Minimum no. of relays shall be six/eight/twelve (6/8/12) so as to maintain power factor in the range of 0.95 lag.

(3) Capacitor Banks

- (a) Capacitor banks shall be of super heavy duty low loss, complete in set, mixed dielectric type and shall be sized to appropriate rating to improve the power factor with target of at least 0.95. Existing power factor can be considered as 0.8 for working out the capacity. It shall be placed on a suitable location on incoming side as per directive of the Engineer. The capacitor shall be of the type and capacity as approved by the Engineer.
- (b) The capacitor shall be designed to carry a maximum current 1.8 times the rated current of capacitor continuously. The components shall be suitably de-rated.
- (c) The capacitor units shall be hermetically sealed for complete protection against leaks. Capacitors shall be certified under UL 810 recognition programme.
- (d) Capacitors shall become part of the LT control panel and shall be located preferably at the top tier /rear side with substantial ventilation louvers for the dissipation of heat, energy from the capacitor losses. The lower/front tiers of the panel shall accommodate switches, MCBs, contactors, and power factor control relay for the automatic switching of the capacitors. The panel shall be cubicle type forming the part of main LT panel.
- (e) Capacitors shall be heavy duty metalized polypropylene dielectric media.

Unit shall be low loss and be able to withstand 10% over voltage and also suitable for continuous operation at rated KVAR. Insulated leads shall comply with UL 62.

- (f) Capacitors shall be subject to test program as per UL810 to evaluate protection devices within the capacitor, dielectric strength, life etc.& other routine & type tests as per IS:2834.

(4) Discharge Resistor

The capacitor units shall be provided with discharge resistors which shall safely discharge the capacitors to less than 50V within 1 minute upon disconnection.

(5) Detuned Filter

- (a) LV Harmonic Filters shall be used with harmonic detuned filter duty power capacitors to mitigate harmonics, improve power factor and avoid electrical resonance in LV electrical networks.
- (b) The low voltage filter reactor shall be series type having a three phase, iron core construction suitable for indoor use. The reactor shall be air cooled and the layout shall be in accordance with IEC 60076 and IEC 60289.
- (c) The complete unit shall be impregnated under vacuum and over-pressure in impregnation resin and shall be suitable for temperature Class H (T60/H) operation.
- (d) The reactor shall be tested using a separate source voltage test of 0.3kV (coil to core) for 1 minute as per IEC 60076/3 and IEC 60289.
- (e) The permitted tolerance of inductance shall be +3% of rated inductance value.
- (f) Reactor tuning factor shall be as per design requirement and the current rating of the reactor shall include the effects of harmonics and other possible over-currents.

(6) Protection

All capacitors shall be suitably protected against over current and short circuit.

(End of Chapter-6)

CHAPTER 7- CABLES

7.1 GENERAL

- 7.1.1 This section of the Specifications covers the requirements for selection, supply, testing and installation of cables and cable jointing / terminating accessories.
- 7.1.2 The cable size shall be selected as per application duty requirement rated to meet the full load and future expansion requirement as envisaged and designed to withstand the requisite short circuit level as per the relevant standards.
- 7.1.3 The buried cables shall be armoured or metal shielded or both as per application duty requirement with water absorption protection.
- 7.1.4 Cables shall be subjected to all tests as prescribed in the relevant standards. The type test shall be carried out on all sizes of cables as per relevant Specifications.
- 7.1.5 Cable containment and laying shall conform to IEC: 61537 and IEE: 525 or IS: 1255 as stringent to give a higher satisfactory life. The Cable containment system shall be designed and got approved from the employer. The Cable containment system designed shall have spare space for future expansion.

7.2 HT Cable

(1) General Requirements

- (a) All HT (11kV) power cables used for tapping the Power supply for 11 / 0.400 KV Substations shall be rated for application duty requirement. The HT cables shall be armoured to provide protection against mechanical damage and earthing. The Cable sizing shall be as per IEC 60287 suitably de-rated for laying methods as per IEC 60364-5-52. The cable shall be XLPE insulated as per IEC 60502-2 or IS 7098—2.
- (b) XLPE insulated cables shall be rated for continuous operation at a maximum conductor temperature of 90°C and for a maximum short circuit temperature of 250°C.
- (c) The cable selection shall be made as per the most stringent duty application throughout the run of the cable. The insulation thickness and other parameters shall conform to relevant IEC / EN standards. In case the voltage levels are different in IEC next higher voltage may be considered for satisfactory life of the cable for Rail application duty requirement or equivalent rating if available in IS 7098-2.
- (d) XLPE cables shall be provided with a semiconducting tape, XLPE insulation and thereafter a semi-conducting layer drawn through triple extrusion insulation, Insulation screen consisting of non-metallic semiconducting layer & Metallic screen Inner layer, armour and outer sheath generally conforming to relevant standards. The buried cables shall be armoured or metal shielded or both as per application duty requirement with water absorption protection.
- (e) The Cable sheath / metal shield shall be bonded at both ends to limit the induced voltage within the prescribed limit.
- (f) PVC / rubber end caps shall be supplied free of cost for each drum with a

minimum of eight per thousand meter length. In addition, ends of the cables shall be properly sealed with caps to avoid ingress of water during transportation and storage.

- (g) All cables rated for 11kV shall be provided with both conductor screening and insulation screening as per the relevant standard. The conductors shall be provided with non-metallic extruded semi-conducting shielding.
- (h) The conductors shall be of stranded, high conductivity annealed copper / Aluminum Conductor as approved by the Engineer.
- (i) Cables shall be specified as under:
 - (i) Conductor : stranded, high conductivity annealed wire
 - (ii) Insulation : XLPE
 - (iii) Inner sheath : PVC
 - (iv) Outer sheath :FRLS

(2) Cable Accessories

- (a) **Termination Kits:** The termination kits shall be with heat/cold shrinkable type suitable for termination of the cables to indoor switchgear or to a weatherproof transformer/motor.
- (b) **Jointing Kits:** The straight joint through jointing kits shall be suitable for installation on overhead trays, concrete lined trenches, ducts and for underground burial with uncontrolled backfill and possibility of flooding by water and chemicals.

7.3 LT CABLE

(1) General

- (a) All LT power and auxiliary/control cables shall be rated for 1100 V. The cable size shall be selected as per application duty requirement rated to meet the full load and future expansion requirement as envisaged and designed to withstand the requisite short circuit level as per the relevant standards. The Cable sizing shall be as per IEC 60287 suitably derated for laying methods as per IEC 60364-5-52. The LT cable shall be XLPE insulated as per IEC 60502-1 or IS 7098—1.
- (b) XLPE insulated cables shall be rated for continuous operation at a maximum conductor temperature of 90⁰C and for a maximum short circuit temperature of 250⁰ C.
- (c) The buried cables shall be armoured or metal shielded or both as per application duty requirement.
- (d) The Cables up to16 sq.mm shall be 4 core copper conductor XLPE insulated and Cables above 16sq.mm shall have high conductivity stranded aluminum conductors, XLPE insulated. The Cable cores shall be colour coded to the Indian Standards for cables.
- (e) The LT Cable use for connection between 230 V supply from Auxiliary AT to Auto-Source Transfer Switch (ASTS) shall be of minimum two core Aluminium conductor, XLPE insulated Cables.

- (f) The Fire Survival cables shall be provided for life safety exit signage circuits and Fire alarm and detection circuits and other cables will be XLPE with FRLS outer sheath.
- (g) Circuits shall be designated such that the voltage drop at the extreme end shall not exceed 5% in accordance with IE Rules. The total voltage drop from the LT source (transformer LT) to the farthest end use shall not exceed 5%.
- (h) Type of the low voltage cables shall be specified by the category of service as followed:
 - (i) Cables selection for the wiring from Sub-main LV Switchboards, Distribution Board or Load Centre to the equipment load shall be FRLS, XLPE insulated cable, and Lighting cables are also included as specified herein or indicated in the drawings shall be FRLS.
 - (ii) Cables selection for the wiring from service transformer to Main LV Switchboard and to Sub-main LV Switchboards, to Distribution Boards or to Load Centre shall be FRLS, XLPE insulated armoured cables or as indicated on the drawings.
 - (iii) Cables selection for life safety equipment viz. exit signage and Fire detection system shall be fire survival cables as per the relevant standard.
 - (iv) Cables selection for wiring for lighting and control circuit and between equipment inside OCC theatre shall be FRZH fire retardant halogen free, insulated cable as per the relevant standard.
 - (v) Cable selection for the Control wiring and interfacing circuits shall be 1100V FRLS, XLPE insulated cables with / without shield as approved by the Engineer.

(2) Component

(a) XLPE Cable

The cables shall be 1100 Volt grade XLPE insulated with PVC inner sheath steel armoured/ unarmoured and with an outer protective sheath of flame retardant low smoke (FRLS) compound, conforming to IS: 7098 (Part I).

(b) Fire Survival Cable (FS) for Fire Alarm Circuits only

- (i) Fire Survival with the cable size of 6 sq. mm. or less, or branch circuit wire such as fire alarm and life safety exit signage circuits shall be single sheathed and installed in GI - conduit.
- (ii) Conductor shall be stranded plain annealed copper wires, over the conductor; the mica tape shall be applied as the fire barrier tape.
- (iii) Insulation shall be low smoke & zero halogen LSZH cross-linked polyethylene (XLPE) thermosetting compound conforming to BS 7846.
- (iv) These cables shall be resistant to flame temperature of 900⁰C for 20 minutes as per NBC Code Part 8, Sec. 2.
- (v) Cables shall not generate corrosive and toxic gases when burnt.

(c) Control Cable

- (i) All control cable shall be suitable for installation in wet and dry locations. The conductor shall be of soft or annealed strand uncoated copper wire.
- (ii) The cable shall be helically wrapped over the filler and have copper shielding with non-hygroscopic Mylar or Polyester tape.
- (iii) The shielding, for control cables, shall be annealed aluminium tape of suitable width and shall be helically applied with a minimum 10% lap. The annealed aluminum tape shall be a least 0.1mm thick and substantially free from burrs.

(d) Cable Accessories

- (i) **Termination Kits:** The termination kits shall be suitable for termination of the cables to indoor switchgear or to a weatherproof transformer/motor.
- (ii) **Jointing Kits:** The straight joint through jointing kits shall be suitable for installation on overhead trays, concrete lined trenches, ducts and for underground burial with uncontrolled backfill and possibility of flooding by water and chemicals. Installation.

In general, the Power cables shall be run in conduits, in cable tray and shall be run concealed in ceiling, floor, and wall or as indicated on the Drawings.

7.4 LAYING OF HT / LT CABLE

7.4.1 Laying of Cable

- (1) Underground cables below road/ passages/railway tracks etc. shall be laid through GI pipes/ HDPE Pipes. Laying of cables at other places including recessing in platform/ wall as required shall be done as approved by the Engineer and shall include RCC/ HDPE/ GI pipe as required, digging of cable trench in ground, making chase in wall/ platform, sand cushioning, protective covering with second class bricks, refilling of the trench/ making good the chase, making end termination with aluminium, crimping socket/ lugs etc. shall be as per the approved drawings.
- (2) In case the cable to be laid underground in RCC pipes, the pipe shall be of the approved diameter, ISI marked socket and spigot type. Trench for laying the RCC pipes shall be excavated in straight lines. Thereafter the trench shall be backfilled with the excavated earth / good quality earth in layers not exceeding 300mm, rammed and watered as necessary.
- (3) In case of the cable to be laid underground under running roads/ railway tracks/ urban areas, where it is not possible to provide open trenching, it shall be laid with trenchless method and shall include HDPE pipe of grade 63 – PN 4 of the approved dia. and conforming to IS: 4984-1985 (latest version) with couplers and as approved by the Engineer. Drilling/ boring shall be in straight lines.
- (4) In case the cable is to be laid in trench, the trench shall have 100 mm sand cushioning and sand cover of 100 mm. Physical protection of cable shall be provided as per National Building Code of India 2005 Part 8, section 2, Para 5.6.2. On transformer side the cable shall be held with "U" frame manufactured with MS

angle 50x50x6 mm & grouted vertical in floor. Cable shall be held vertical with clamps of MS flat 50x6 mm at two places on frame on transformer side.

- (5) The cable laying work shall be done in accordance with CPWD General Specifications for Electrical Works- Part II (External) 1994 with latest amendments.
- (6) Testing of the complete installation shall be as per clause 2.8.2 & 2.8.3 of CPWD General Specifications for Electrical Works- Part II (External)-1994.
- (7) To prevent entry of rodents, dust, water, Cables passing through the walls or entering the installation shall be sealed through EPDM (Ethylene Propylene Diene monomer) based modules. Module shall have low smoke index, halogen free cross linkable rubber compound.
- (8) The cable laying shall be carried out as per IS: 1255 – 1983 (Code of practice for installation and maintenance of power cables up to and including 33 kV rating), IEC 61537 and/ or IEEE: 525.
- (9) Minimum depth of directly buried in ground Cable / pipe at various locations from the ground surface shall not be less than as indicated here under:-

Sl. No.	Location	Depth of top of directly buried in ground Cable / pipe	Remarks
1.	Under-ground	Not less than 750mm for LT cables and 1000mm for HT cable	Cables to be laid in single tier formation
2.	Under road	Not less than 1000mm	
3.	On Platform	Not less than 750mm for LT cable	
4.	Under Railway Track	1500mm measured from the bottom of sleepers to the top of the pipe	
5.	In wall/ floor	To be recessed (for LT cable)	
6.	Other than above	As approved by the Engineer	

- (10) Minimum width of cable trench for laying of Cable at various locations shall be as under:-

Sl. No.	Location	Width of trench for cable directly buried in ground	Width of cable trench for one additional cable	Remarks
1.	Under-ground	350mm approx.	350mm + 250mm	Brick on edge should be laid in between the two juxtaposed cables
2.	On Platform	350mm approx.	350mm + 250mm	
3.	Under Road	350mm approx.	Not allowed	-
4.	In wall/ floor	To be recessed as approved by the Engineer	As approved by the Engineer	-
5.	Other than above			

- (11) Protective covering, sand cushioning of cable & making good all surfaces at various locations wherever digging was carried out shall be as under:

Sl. No.	Location	Protective Covering	Sand Cushioning	Surface
1.	Under-ground	Brick 9"x4"x2.1/2" (normal size), Width wise on top and length wise on sides	Base cushion 80 mm under cable & 150mm above laid cable	Making good as original
2.	On Platform	-do-	-do-	-do-
3.	Under Road	Through laid pipe	----	-do-
4.	Under Railway Track	-do-	----	Making good damages
5.	In wall/ floor	Plastering	----	Making good as original
6.	Other than above	As approved by the Engineer	As approved by the Engineer	As approved by the Engineer

7.4.2 Cable route marker

- (1) Prominent cable route marker shall be used.
- (2) The route marker shall be mounted parallel to, and at a distance of 300mm from the edge of the trench and shall be grouted with cement, sand & aggregate mixture in ratio 1:2:4 at a depth approx. 400mm in ground. The word "Voltage", "Size of cable" and "Depth" should be inscribed on the route marker plate on one side and DFCCIL inscribed on the other.

7.4.3 MS Chequered Plate for Covering Cable Trenches

5/6 mm thick MS chequered plate shall be used for covering cable trenches in sub-station. It shall be cut to size as required and painted with enamel paint of approved shade after treatment of anti-corrosion.

7.4.4 GI Pipe for Passing Cable

- (1) GI pipe shall be of required diameter and shall be ISI marked and shall not be less than of Class 'B'. It shall include making chase and plastering after laying of the pipe in wall or on platform / digging of trench under the railway track / road and refilling of the trench with excavated earth after laying of pipe and making good the damages. Excavation shall be done complying with Code of safety as per IS: 3764-1992 (latest version). Care shall be taken to ensure that not more than 30 – 35% space within the Pipe is occupied.

7.5 CABLE SEALING SYSTEM

7.5.1 General

- (1) After erection of materials and equipment through wall and opening has been completed, it is the responsibility of the Contractor to fill up voids and openings with fire resistant materials to protect fire or smoke from spreading out from one room to other room or one floor to another floor through these voids and openings.
- (2) Fool-proof sealing system is a pre-requisite for ensuring protection against Fire, Water, Energy/Power Loss, Humid Temperature Variations, Pull Tension and Rodents, wherever cables are entering in to the Electrical Sub-station, Control Room, SCADA Room, Electrical Equipment, Cabinets, Power and UPS-Battery Room, Transformers, Building and Power equipment.

7.5.2 Applicable Codes and Standards

The fire barrier shall comply with the following codes and standards:

NEC: 300-21 : Spread of Fire or Products of Combustion

7.5.3 Material Description

Specifications: Composition: Low Smoke Index, Halogen Free Rubber compound based on Ethylene Propylene Diene Monomer (EPDM). The material (EPDM rubber) of module with centre plug/wrap/core shall be fire resistant as per UL 1479 of BS 476/20 and ensure protection against Dust, Water and penetrating solid objects as per IP54 for all indoor applications and IP65 for all outdoor applications (IEC 60529). The fire resistant rating of the sealing material shall be more than 2 hours.

7.5.4 Installation of Fire Barriers

- (1) The fire barrier materials shall be installed where:
 - (a) Voids, sleeves, and openings appear on wall, floor, beam and shaft, provided for raceway installation, which must be sealed after the erection work, shall be completed.
 - (b) Voids, sleeves, and openings provided for future installation.
 - (c) Voids exist between electrical conduits and sleeves.
 - (d) Voids exist between electrical cabling and raceway on fire wall and floor.
 - (e) Voids exist between raceway and sleeves on fire wall and floor.
 - (f) The method of fire barrier installation shall be in accordance with the manufacturer's instruction and listings.

7.6 TESTING AND COMMISSIONING

- (1) The type test certificates of cables supplied shall be submitted for all sizes. Where the type test are older than 3 years or the process is changed, Type test shall be conducted as per the relevant standards and a report shall be shared to demonstrate the proven quality of the product offered.
- (2) Power cables, 1100 volts rated, shall be meggered phase-to-phase and phase-to-ground before the equipment is connected and phase-to-ground after the equipment is connected and all connections are taped.
- (3) Insulation resistance tests shall be performed by using a 500 V DC Megger on the 400 volts system. Insulation resistance shall be not less than 50 mega-ohms per 1000 volts rating.
- (4) Wiring Continuity Test: All wiring systems shall be tested for continuity of circuits, short circuits, and earthing after wiring is completed and before installation is energized.
- (5) The testing method shall be as provided by the manufacturer in conformance to relevant standards.

(End of Chapter-7)

CHAPTER 8–WIRING, CONDUIT, CABLE TRAY AND RACEWAY

8.1 GENERAL

The Contractor shall design, supply and install the Cable containment system i.e. conduits, wiring there in, cable trays and raceways etc. for TNS earthed system as generally described or indicated on the Drawings and specified herein as required and as per application duty requirement for the Auxiliary Power Supply and Distribution system including sub-stations, internal and external electrification for all the buildings, staff housing, depots, club / Institute etc. at Station areas, including surrounding compounds for its own purpose as well as for all Designated Contractors.

8.2 MATERIAL DESCRIPTION

The Cable containment system i.e. conduits, cable trays, supports and raceways etc. shall be designed and manufactured in accordance to the Indian Standards or International Standards and accepted by the Engineer and shall be installed to comply with relevant provision in Indian Standards Specifications, Indian Electricity Rules and IE wiring regulation.

8.3 COMPONENTS

8.3.1 GI Conduits and Accessories

- (1) The contractor (CP105) shall provide the concealed conduits for the Buildings constructed by him and at rest of the areas the CST contractor shall lay the conduit along with Fish wire. The detail of scope of buildings to be constructed by contractor (CP-302 & CP105) is defined in chapter 3: Scope of work.
- (2) The steel conduits shall be made of hot-dip galvanized, produced in electrical resistance welding process with the weld bead on both inside and outside removed in accordance with Indian standard IS:9537 part 3 or equivalent.
- (3) Flexible conduit and fittings for life safety equipment shall be galvanized, water-tight pattern, flame retardant, Low smoke and fume, over-sheathed and separate earth wire enclosed within the conduit (if applicable).
- (4) The standard manufactured elbows shall be used for all sizes of conduits diameter larger than 1 inch (25mm), and the field bends to be handled with great care not to damage the conduits, shall be permitted to be used for conduit of 1 inch and smaller.
- (5) The conduits shall be defined in SI units as on the drawings. The table below show the comparison of diameters of conduit in inches and in mm.

Conduit Diameter in Inches	½	¾	1	1 ¼	1 ½	2	2 ½
Conduit Outside Diameter in mm	16	20	25	32	40	50	63

8.3.2 Cable Tray

- (1) Cable trays used in indoors shall be made of hot-dip galvanized steel after fabrication to provide good corrosion resistance during storage, installation and

service life. The ventilated type cable tray, punching, with cover shall be provided with the dimensions as indicated on the drawings.

- (2) The number of cables installed on the cable tray shall be provided in compliance with the requirements of the Indian Standards Specifications, Indian Electricity Rules and IE wiring regulation. And 40% spare space capacity shall be provided for cable laying inside the cable tray.
- (3) Cable tray or ladder shall not be installed across building or structural expansion joints. On horizontal runs the tray or ladder shall be installed with a 20 mm gap at the expansion joint. Supports shall be installed within 150 mm on either side of the joint.
- (4) Wherever Cables are laid in cable trays these shall be concealed above false ceiling. Trays shall conform to NEMA with minimum 2.0 mm thickness, perforated, galvanized sheet steel.
- (5) The cable containment system of trays, ladders and support shall conform to IEC 61537. The cable containment system shall be designed as per application duty and will be approved by the Engineer.

8.3.3 Raceway

- (1) Raceway shall be made of hot-dip galvanized steel after fabrication to afford good corrosion resistance during storage, installation and service life and shall be provided to form the continuous steel sheet troughs with removable covers attached to the raceway by screws for housing the cables. The minimum thickness required for raceway shall be as per the following table (in millimetre unit):

Size of cable raceway (width x height)	Thickness
50 x 50 up to 100 x 50	1.6
100 x 100 up to 150 x 100	1.6
200 x 100 up to 300 x 100	2.0
150 x 150 up to 300 x 150	2.0
Larger than above	2.0

- (2) The Raceway Junction BOX Cover plates shall be of minimum 3 mm Stainless steel made of SS-304.
- (3) Separated raceway for normal, essential and emergency circuits shall be provided as indicated on the drawings.
- (4) Each section of the raceway shall be electrically bonded, with a minimum 6 mm² cross section area earth-bonding strap or wire, to the next section to form an electrically continuous system and bonding to the main grounding system shall be copper with green/yellow, low smoke zero halogen material, sheathed, single core cable. The number of cables installed in the raceway shall be provided in compliance with the requirements of the Indian Standards Specifications, Indian Electricity Rules and IE wiring regulation. 40% spare space capacity shall be provided for cable laying inside the raceway.

8.3.4 Boxes and Accessories

- (1) All boxes provided in the conduit work shall be made of metal. A box provided for cable connections and concealed in ceiling shall be a standard galvanized steel square or circular box or a metal box, made of steel sheet with not less than 1.6 mm thickness, with one primer anti-rust coated and two coating finishes.
- (2) All wall/ceiling boxes on exposed work if any shall be of die cast aluminium or

cadmium-plated cast-iron. All boxes and conduit accessories shall be fully weather-proof when used in outdoor locations and other locations as agreed during construction.

- (3) Conduit outlet boxes, for socket outlets, lighting switches, etc., shall be of hot-dip galvanized steel complete with adjustable lug, ample knockouts, and brass earth terminals fitted in the base.

8.4 WIRING

- (1) The Contractor (CP-105) shall complete the wiring of all Service and ancillary Building along with all wirings and fans and light fixtures including Air-conditioning as required.
- (2) Wiring shall be done as per CPWD specifications for both internal as well as external electrification. For internal wiring following parameters shall be used:
 - (a) For point wiring 2X2.5 sq mm wire 1X2.5 sq mm for earth multi strand copper cables shall be used.
 - (b) For 16 amp power socket wiring 2X4 sq mm wire 1X4 sq mm for earth multi strand copper cables shall be used.
 - (c) For split AC outlets power socket wiring shall not be less than 2X6 sq mm wire 1X6mm for earth multi strand copper cables.

8.5 APPROVAL OF MATERIAL, FIRST FIX FOR ELECTRICAL INSTALLATION

The contractor shall propose the material to be used for the work as per the requirement and Contract Terms and Conditions in requisite format along with details of performance compliance and sample if any as possible and produce for first fix for electrical installation before it is replicated or used elsewhere for approval of the Engineer.

8.6 TESTING AND COMMISSIONING

The scope of the work shall include Field inspection and testing for conduit, cable tray and raceways installed to be carried out prior to energization of any equipment / system.

(End of Chapter-8)

CHAPTER 9– LIGHTING SYSTEM

9.1 GENERAL

- (1) The Contractor shall design, supply, install, test and commission a high efficiency lighting system (indoor and outdoor) for all Service buildings i.e. S&T Service Buildings in the block section (Auto Location Huts) consisting of Signalling Equipment Rooms, Telecom Equipment Rooms, Signal & Telecom Power Supply Equipment Rooms, GSM-R equipment rooms; any additional Service buildings for S&T works in Station and Block section and other buildings as constructed for Dadri – Khurja Section of EDFC. Light fittings shall be complete with lamps, supports and accessories; ceiling fans complete with electronic regulators; lighting panels, lighting poles complete with distribution boxes. The light fittings and all associated accessories shall be subject to the acceptance of the Engineer.
- (2) Illumination levels shall be of uniform distribution throughout the area, and shall be designed with accredited lighting software such that glare, dark recesses and areas of poor lighting levels are avoided. Illumination level at main entrance, top and bottom landing of stairs shall be maintained 2 times higher than the normal light level.
- (3) Scale of fittings for Staff Quarters shall be as shown on Attachment 20.5.
- (4) The contractor shall submit lux profile for all indoor and outdoor lighting system, with fixtures and lamps to be used, to the engineer in charge and obtain the approval of the employer and there after submit a lighting and conduit layout drawing for final approval before execution at site. This should also be accompanied with a schedule of lighting fixtures and type of switches and sockets to be used, for approval. The lighting load should be equally distributed between all the three phases and a DB distribution schedule/diagram shall also be submitted for approval.

9.1.1 Illumination levels

- (1) The type of Luminaires and normal average standard illumination levels for various areas and services shall be as shown in Attachment 20.2.
- (2) Lux levels in areas not covered in this attachment 20.2 shall be taken from the National Building Code / Indian standard 3646.
- (3) All Indoor fittings shall be IP-54 compliant .All Outdoor fittings shall be IP65 compliant seal safe or equivalent.

9.2 SYSTEM DESCRIPTION

The lighting system shall comprise of the following:

(1) Normal Lighting

The lighting and power load fed from transformer and Main Distribution Boards shall be defined in terms of normal load. .

(2) Essential Lighting (DG Power)

The lighting and small power load is fed from DG / MLDB whose incoming power supply is hooked up by a DG power supply during main failure defined in terms of Essential load. Minimum 30% of lighting fixtures in all areas shall be essential light

fixtures with minimum of one number in any enclosed room/ compartment.

Essential light fixtures shall be provided at all exit routes powered on DG backed Essential power supply.

(3) Emergency Lighting (UPS Power)

The critical lighting and small power socket for computer is fed from UPS during main and DG failure defined in terms of Emergency load. Minimum 20% of lighting fixtures in all areas shall be very critical light fixtures with minimum of one number in any enclosed room / compartment.

Critical light fixtures shall be provided at all exit routes powered on UPS backed power supply.

9.3 GENERAL REQUIREMENTS

- (1) No incandescent lamps shall be used.
- (2) All indoor luminaires shall be **LED** fixtures as per Attachment 20.2.
- (3) Street lights shall also be LED type.
- (4) All LED fixtures shall have a power factor of more than 0.95.
- (5) A sample of the system of illumination as proposed to be adopted for the contract shall be approved by the Engineer in each type of building before their use in the contract.

9.4 OUTDOOR ILLUMINATION

The Outdoor/ road/ street lighting design with detailed drawings shall be prepared by the Contractor (CP-105) and submitted to the Engineer for obtaining consent of the employer. Roads constructed by contractor (CP-302) shall be lighted using 7 meter high decorative octagonal GI pole (conforming to British Code of practice CP3) suitably spaced to give uniform illumination. Smaller roads/ streets shall be illuminated using steel poles generally conforming to IS: 2713- (Part I-III). The street/road lighting shall be designed to achieve average 20 lux with uniformity as per A2 category of road (defined in IS: 1944). The Contractor shall illuminate the approach road connecting to TSS/SSP constructed by Contractor (CP-105) with similar lighting level. The layout drawings shall be submitted for approval. The Contractor shall submit detailed calculation for reaching specified Lux level. Area lighting cable schedule etc. shall also be prepared by the contractor for approval.

9.5 INDOOR ILLUMINATION

- (1) The indoor lighting design with detailed drawings including conduit layout shall be prepared by the Contractor (CP 105) and submitted to the Engineer for approval.
- (2) The conduit layout for all buildings shall be based on the drawings developed by the Contractor. Electrical distribution diagram for all building and for area lighting cable schedule etc. shall also be prepared by the CP-105 Contractor.
- (3) The CP 105 contractor shall interface with CP-302 Contractor for laying of concealed conduit in the buildings to be constructed by the CP-302 contractor. The Contractor shall submit detailed calculation of Lux levels achieved.

9.6 INTERNAL WIRING OF SERVICE BUILDINGS, STAFF QUARTERS, CLUB / INSTITUTE AND OTHER ANCILLARY AND ASSOCIATED BUILDINGS

- (1) IS: 732-1989 Code of practice for electrical wiring installations shall be followed.
- (2) Type of wiring conductor Multi-stranded copper conductor 1100V grade FRLS only.
- (3) 20% of the wiring circuits shall be designed for critical exit light in the station area / depot area etc. (fed by UPS).
- (4) 30% of the wiring circuits shall be designed for Essential light & fan loads in the station area / depot area etc. (fed by DG set).
- (5) Not more than 800 W connected load or more than 10 points on any single circuit shall be provided.
- (6) Power circuit shall be designed for only one outlet per circuit.
- (7) PVC conduit shall be used in staff housing / quarters only with minimum conduit size 25mm. The conduit in quarters shall be concealed type.
- (8) Load balancing in the circuits.
- (9) Wiring for normal, essential and emergency circuits in separate conduits.
- (10) Essential / emergency wiring circuits fed by DG set and UPS shall be wired in separate conduits.
- (11) Test for earth continuity; load balancing, insulation resistance & polarity test.
- (12) Only looping system of wiring shall be followed.
- (13) Every room shall have power outlet for AC/Desert Cooler along with its controlling MCB.
- (14) Provision of MCB box near entry for switching off supply.
- (15) Joints in the wiring shall not be permitted.
- (16) Conduit fill shall not be more than 40%.
- (17) Maximum wires in the conduit to be laid as per IS 732:1989 guidelines.
- (18) Essential circuit fed by DG set shall feed essential lighting, fans and small power sockets as described in the relevant chapter.
- (19) Emergency circuit fed by UPS shall feed very critical lighting and small power socket as described in the relevant chapter.
- (20) Fuses or single pole switches shall not be connected in series with the neutral connection of the mains power supply.
- (21) Power supplies feeding vital signaling interlocking and control circuits shall be self-contained, shall not feed other equipment or systems.
- (22) Hardware & screws shall be cadmium plated with counter sunk heads.

9.7 MATERIAL DESCRIPTION

The Luminaires as specified herein comprise of the lighting fixtures, lamp holders, lamps, ballasts, starters, emergency/exit lights and street lighting fixtures.

9.8 COMPONENTS

(1) Lighting Fixtures: LED type

(a) Fixture

- (i) The fixture shall be suitable to work under following ambient conditions.
- (ii) Housing, if not used as a heat sink shall be made of at least 0.5 mm thick sheet steel, extruded Aluminium (minimum 1.0 mm thickness) or pressure die cast (minimum 1.6 mm thickness), conforming to relevant standards, polyester powder coated of at least 40 microns) and high U.V. & corrosion resistance.
- (iii) Heat sink used should be Pressure Die-Cast Aluminium die cast having high conductivity preferably ADC 12 or LM 6. The Manufacturer' name shall be embossed on the housing of die-cast fixtures.
- (iv) Luminaire should be covered with suitable Glass or diffuser with high Transmittance, all outdoor application luminaires shall be supplied with either clear toughened glass or clear polycarbonate cover for better IP retention and higher life.
- (v) Lighting fixtures and accessories shall be designed for continuous trouble free operation under diverse atmospheric conditions without deterioration of materials. Degree of protection of enclosure shall be at least IP-65 for outdoor fixtures, bulkhead fixtures.
- (vi) The fixture should have the associated LM-79 and LM-80 report from a recognized lab. Test reports shall be submitted along with relevant catalogues as part of the bid document.

(2) LED: High lumen efficacy LEDs suitable for the application along with following features shall be used:

- (a) LED Efficacy at the chip level shall be >120 lumen/watt (For High power LED).
- (b) The efficiency of the LED fixtures at 85⁰C junction temperatures shall be more than 85%.
- (c) The luminous efficacy of LED luminaire shall be at least 60 lumen/Watt for low wattage luminaires (<45W system – including driver losses) and at least 70 lumen/watt for high wattage luminaires (>45W system – including driver losses).
- (d) Adequate heat sink with proper thermal management shall be provided.
- (e) Power factor of complete fitting shall be more than 0.90 at full load.
- (f) Color rendering index (CRI) shall be at least 70 for both indoor and outdoor applications.
- (g) Correlated color temperature shall be in range 4000 K to 6500 K.

(3) LED driver: LED driver shall have following features:

- (a) Fixture shall be designed to sustain an input voltage range within 160V

(RMS) to 270 V (RMS).

- (b) Driver shall be designed to withstand surges of at least 1.5 KV.
- (c) Operating input voltage 220-230V (RMS).
- (d) Power factor > 0.95.
- (e) Full Load Efficiency ≥ 85%.
- (f) Total Harmonic Distortion (THD) shall be < 25 %.
- (g) Current waveform should meet EN 61000-3-2.
- (h) The driving current of LED drivers shall be lower for higher LED life as approved by The Engineer.

9.9 SIGNAGE

- (1) For indoor application signage shall be of back lit LED. Signage shall be aesthetically designed. Power supply to signage shall be through emergency circuit. For outdoor/yard areas signage shall be retro reflective.
- (2) The signage shall conform to RDSO specification no. RDSO/PE/SPEC/TL/0086-2009 (Rev. '0')

9.10 LED STREET LIGHT LUMINAIRES

- (1) Street light luminaire (of required Wattage) shall be of LED type, energy efficient and complete with all accessories as required and as approved etc., 2x1.5 + 1x1.5 sq. mm, FR PVC insulated multi-stranded single core copper conductor cable, GI pipe bracket (of approved length) and GI flat clamps with nuts and bolts etc. as required and as per approved drawings.
- (2) Requirement for provision of the luminaire are as under:

Sl. No.	Location	Requirement
1.	On pipe bracket of erected pole	Directly on bracket including wiring from Junction box as required
2.	On wall of the Building	On wall including supply and grouting of 600 mm long GI pipe bracket and wiring from light point as required

9.11 SWITCH AND SOCKET OUTLET

9.11.1 Scope

The Contractor shall supply and install the switch and sockets outlets in the buildings taking into account functional requirements / applications for all the equipment that shall be required after obtaining approval of the Engineer.

Matrix of requirements at various locations has been indicated in attachments 21.1 to 20.5.

9.11.2 Material Description

The colour of cover plates for all switches and socket outlets (except power outlets) shall be selected conforming to the decorative finishing of architectural work.

9.11.3 Components

(1) Switches

- (a) In general, the switches shall be of the concealed, grid plate mounted, modular type rated 6/16 Amperes at 230 V and with indication light.
- (b) Switches located in wet and outdoor locations shall be complete with waterproof cover plate, housed in a galvanized cast iron or impact resistance moulded plastic enclosures providing the minimum degree of protection of IP54.

(2) Socket Outlet

- (a) The switch-socket outlets shall be 6A,230V, Five (5) pins, and 16 A, 230 V, six (6) pins, modular type with flush grid plate mounting, unless otherwise stated, fitted with automatic linear safety shutters to finger proof.
- (b) The cover plates of the outlets shall be aluminium anodized or stainless steel, or as specified on the Drawings. Cover plates shall be of the same manufacture and shall match the switches in the particular room or area in which they are installed.
- (c) Water-proof sockets shall consist of a single outlet in an outlet box with gasket, water-proof, complete with cover plate conforming to IP65 protection for exposed area and IP54 for indoor used.
- (d) The switch-sockets shall be rated 6/16 Amperes at 230 V, 2 wires with third pole grounded (SP&N).
- (e) The power socket outlets for maintenance purpose shall be supplied at 32A, 400 volt, 3-phase, 50 Hz. The socket outlets shall be 3 poles with neutral and earth (TP&N) rated to IP54 for indoor use and IP65 for external use or in wet environment locations.
- (f) Residual current devices of 30mA sensitivity shall protect all sockets. RCCB-ELCB shall be housed in an enclosure incorporated into the MCB distribution boards or Load Centre Panels.
- (g) Power outlets shall be used for Rail maintenance in Maintenance workshop areas, shall be surface mounted, weather proof, complete with plug and shall comply with IEC60309-2. Weather proof outlets shall be rated to IP65 as a minimum. The power outlets shall be as below list; 63A, 3P+N+G, 400V AC, completed with plug, surface mounted. 16A, SP+N+G, 230Vac, completed with 2 edge plugs, cord 3m, surface mounted.

(3) Testing and Commissioning

The complete switches and sockets shall be tested to ensure that the operation is in compliance with the requirements.

(End of Chapter- 9)

CHAPTER 10 – SCADA SYSTEM FOR AUXILIARY POWER SUPPLY

10.1 SCOPE

- 10.1.1 Design, manufacture, verification, delivery, installation, testing, commissioning (including integrated testing and commissioning) and technical support of Auxiliary SCADA system for complete monitoring & control of Auxiliary Power Supply system and other E&M functions as detailed vide item 10.3 below.
- 10.1.2 SCADA for auxiliary power supply shall be separate system independent of SCADA for traction power.
- 10.1.3 The Dadri - Khurja section is in continuation to the preceding Bhaupur – Khurja sections (contract packages CP – 104). The SCADA control and monitoring of the entire section will be from the centralized Operations Control Centre (OCC). The OCC building is being constructed at Allahabad, under the scope of CP 104 contractor.
- 10.1.4 The CP 105 Contractor shall be responsible for design, supply, installation, testing and commissioning of SCADA equipment for control and monitoring of Auxiliary Power Supply System for Dadri – Khurja section. The CP 105 contractor shall adopt architecture of the SCADA system for Dadri – Khurja section similar to the SCADA system of the adjacent New Bhaupur – Khurja section being implemented under CP- 104 Contract and augment the CP-104 SCADA System, so as to facilitate up gradation and integration of control and monitor of Auxiliary Power Supply installations through the SCADA equipment provided by the CP 104. There is however no bar of adopting a new system which is in compliant with the CP 104 system and integrating it with the CP-104 SCADA system at the centralized OCC with the objective of having the same look and feel for seamless operations at the OCC.

10.2 GENERAL REQUIREMENTS

- 10.2.1 The Auxiliary SCADA system shall comprise as applicable, without limitations, the following:
- (1) Head end servers and databases
The Auxiliary SCADA system shall be implemented with single or collection of Computer Servers (Server Cluster) in single or multi-tier architecture respectively. Thus, the “SCADA Server Hardware” implies Single Computer Server or Multiple Computer Server and shall essentially include but not limited to:
 - Services/Component required for SCADA Application
 - Services/Component required for Communication with process units (RTU's) or external systems
 - Services/Component required for Database Management
 - Services/Component required for Programming & Development
 - (2) SCADA Local area network (LAN), setup in OCC for data exchange between various devices (Servers, Workstations, Printers, Video Control Panel etc.)
 - (3) Dedicated Work Stations / MMI terminals at OCC, Station and IMSD.

- (4) Data Logger and Operator Printers in OCC
- (5) Remote Terminal Units (RTU)
- (6) SCADA Application Software, RTU configuration Software required for implementation of above
- (7) Communication Equipment's (Router, Switch, cables etc.) to achieve interface of RTU with OFC ring and further data transmission to OCC
- (8) Remote Input / Output (I/O) Units
- (9) All equipment power supplies, cables, connectors, accessories, cabling and earthing necessary for the work
- (10) Mounting brackets, equipment cabinets, racks, installation materials
- (11) Other equipment as necessary to fulfil the specified requirements.
- (12) The Auxiliary SCADA system shall be full Hot Standby redundant system.
- (13) The Auxiliary SCADA system shall transmit metering data, indications, alarms and controls in real time between various E&M equipment and the OCC, via. fibre optic network.
- (14) Stations reports, information storage and retrieval, alarm process, incident reports and operation reports shall be provided at the OCC as well as at IMSD.
- (15) The system shall be capable of transmitting digital status and control data and analogue management data.
- (16) All processing equipment shall be individually addressable.
- (17) The Auxiliary SCADA shall be based upon an open modular architecture approach, which compliant with the Open Software for Formulation Distributed Computing environment for distributed computing function and portable hardware platforms of different origin. The modular architecture shall permit expandability for future Non-Traction supply applications.
- (18) Auxiliary SCADA system shall:
 - (a) Be provided with the processing capability and memory required for Non-Traction supply including hardware platform, application program, database, displays and logs.
 - (b) Be designed to have the capability to support minimum 20% additional processing increase in number of I/O without degrading performances.
 - (c) The Auxiliary SCADA System shall be immune to electromagnetic interference (EMI) from nearby high current electrical equipment to ensure safe and reliable operations under all loads and faults.
 - (d) The Auxiliary SCADA equipment shall be capable of accommodating variation (without degradation in communication) in line impedance delay distortion, or other causes that may be expected on these types of circuits.

10.2.2 The contractor shall submit a comprehensive list of all input/output points, and alarms to the Engineer for approval. This document shall be based on the contractor's detailed design and shall include, but is not limited to, the details of signal type, field I/O operation and operating parameters to enable a complete and comprehensive detailing of the SCADA system.

10.2.3 A GUI based graphical display panel/ works stations shall be provided in Station Master Room or any other place like depots etc. as identified by the Engineer, where status of some of the critical functional units can be displayed with alarm.

10.3 FUNCTIONAL REQUIREMENTS

10.3.1 The contractor shall design, manufacture, install and commission the monitoring or facilities system to provide a safe, efficient and effective means of monitoring and controlling the connected equipment as required in these specifications.

10.3.2 The Auxiliary SCADA system shall comprise of the following elements:

- (1) Interfaces to Traction SCADA workstations for displaying the status of connected equipment and allowing operators to control some of the equipment.
- (2) Data communication links between the connected equipment to be monitored / controlled by the SCADA system.
- (3) The Auxiliary SCADA system shall be fully Hot-Standby redundant system.
- (4) The SCADA system (Servers, Workstations, RTU's etc.) shall be synchronized with Master Clock.
- (5) Energy Meter Recording & Accounting.
- (6) Interface with Fire Alarm Control Panel, CCTV, Intruder and Detection System.
- (7) Interface with Existing OCC.
- (8) Interface with Telecom SCADA for Security.

10.3.3 The SCADA software & RTU hardware shall be as per PS Electrification (Vol. 2).

10.3.4 Control & Monitoring requirement of Auxiliary Installations for Auxiliary SCADA have been detailed below:

MONITORING CONTROL PARAMETERS FOR SCADA - AUXILIARY POWER SUPPLY

Sr. No.	Functional Unit	Minimum Status (indicative)	Minimum Control Parameters	Station	IMSD	S&T Equip. rooms in Block Section	Control Room TSS/ SSP
1.	DG Set	Status (ON/OFF) and other parameters as required	Remote operation/ shut down of DG set	YES	YES	NA	NA
		DG Breaker (ON/OFF)	DG Breaker Operation	YES	YES	NA	NA
2.	Main HT Panel	Supply Availability, Electrical Parameters, Voltage, Current, Power Factor, Energy, etc. and other parameters as per specifications.	Breaker Control	YES	YES	NA	NA

3.	Main Distribution Panel	Supply Availability, Electrical Parameters, Voltage, Current, Power Factor, Energy, etc. and other parameters as per specifications.	Breaker Control	YES	YES	NA	NA
4.	SDB's (at Station/ IMSD' etc.	Supply Availability	NIL	YES	YES	NA	NA
5.	Fire Alarm Control panel	Status & Alarm	NIL	YES	YES	YES	YES
6.	Access Control	Status & Alarm	NIL	ASS only	NA	NA	YES
7.	Solar Panel Supply	Quantum of Solar Power generation and other parameters per specification.	NIL	YES	YES	NA	NA
8.	UPS	Status (ON/OFF) and other parameters per specification.	NIL	YES	YES	NA	YES
9.	Aux AT Supply (at ASTS)	Supply Availability	NIL	YES	NIL	YES	Covered in Traction SCADA
10.	Water Pump	Operation Status	NIL	YES	YES	NIL	NIL

(End of Chapter-10)

CHAPTER 11- DIESEL GENERATOR SET (DG SET)

11.1 GENERAL

- (1) The Contractor shall supply, install, test and commission a complete system of diesel generator set in accordance with Attachment 20.2 to 20.4 and Specifications herein and shall be provided in the following locations:
 - (a) Stations and Depots to meet the essential power requirements for the following utilities :
 - (i) Lighting Load: critical lights (@30% of normal light) including Security Light and Signage;
 - (ii) Ventilation;
 - (iii) Fire Detection and Alarm system / Fire Suppression system;
 - (iv) Water Supply & Drainage Pumps
 - (v) Computers, Printers load
 - (vi) SCADA System;
 - (vii) Access control system;
 - (viii) Signalling and Telecom Equipment at stations and depot; and
 - (ix) Other controls & Battery backup requirement
- (2) The DG set shall be working as single unit for catering to mixed load comprising electrical power and for charging battery (Average power factor of load being 0.8 lagging). The DG set should be suitable for operation as per site conditions. The Contractor shall properly calculate the backup power requirement at each place of installation and obtain approval from the engineer. The noise should be within the approved limits as specified by the pollution control board and meet the noise levels specified therein. The contractor shall provide DG sets of same rating for all the stations.
- (3) The DG set shall conform to CPCB-II or latest norms and provided with all the safety equipment to protect against fire risks and take all precautions/ measures.
- (4) DG set shall match or exceed the Fuel efficiency standards in the product range used in the Rail/ Metro Infrastructure projects.
- (5) DG set shall be silent type with the mandatory canopy conforming to CPCB-II or latest norms.

11.2 MATERIAL DESCRIPTION

Design, manufacture, supply, including transportation, storage, loading / unloading and safe custody till handing over, installation, testing and commissioning of the sound attenuated Diesel Generator set.

(1) DG Set with Acoustic Enclosure for Essential Power Supply

DG set shall be of the required capacity / rating as approved by the Engineer and shall be complete with diesel engine, copper wound alternator mounted on a common base frame, battery set, anti-vibration pads, fuel tank, and other

connected accessories / equipment / protective devices etc. along with AMF control panel. The AMF panel is comprising of MCCBs of approved rating, copper bus bars of approved capacity, 4 pole heavy duty connectors of approved rating, Multifunction Panel Meter display parameters indicating Current and Voltage on Phases and Lines, Power Factor, Frequency, KWH, MD etc. along with LED indication lights including connection with cables as required.

The DG Set shall be able to start automatically in all climatic conditions and shall take full load within 10 seconds of failure of the normal supply through an automatic change over switch. On resumption of the supply, the change over to the normal supply shall initiate automatic shutdown. DG set shall also include acoustic enclosure, LT XLPE insulated unarmoured single core aluminum conductor cable of approved size and all other accessories including foundation & supply of High Speed Diesel oil, lube oil etc. as required for testing & commissioning at Site are indicated in scope.

(2) Other Requirements

Other requirements shall be as under and as per drawing approved by the Engineer.

- (a) Ventilation requirement in DG room for optimum DG efficiency and requisite air changes;
- (b) Acoustic treatment of DG room required if any;
- (c) Smoke stack as required

(3) Site Conditions

- (1) Height above mean sea level: As per site of installation.
- (2) Maximum ambient temperature : 50⁰C
- (3) Relative humidity : High humidity Rated Power Output

The Diesel Generating Set shall be capable for delivering continuously (on 24 hours basis) power output at 1500 rpm at site conditions and the engine shall conform to IS 10000 / BS: 5514 (latest version).

The diesel engine shall be capable for working on 10% over load for one hour in any 12 hours running.

(4) Oil Engine

The diesel engine shall be cold starting, vertical direct injection, 4 stroke cycle, water radiator cooled/air cooled as per requirement, turbo charged, electric battery start, directly coupled to the alternator mounted on a combination base plate frame through a flexible coupling. Most compact, extremely robust and rugged design. Minimum 500 hrs oil change interval, meeting emission norms and self-starting. A suitable extension pipe shall be used with exhaust air chest so that the silencer can be mounted.

(5) Fuel Tank

The fuel tank shall have fuel storing capacity corresponding to 12 hrs consumption of the D.G. set. The fuel tank shall be protected by an appropriately sized bond wall, capable of containment of its full capacity. The engine shall be required to operate on Diesel Fuel Oil grade 'A' to IS: 1460.

(6) Governor

The engine shall be supplied with inbuilt electronic governor to maintain the engine speed at varying loads. The governor shall conform to Class A-1 or G3 as per BS / IS (relevant). The engine shall be complete with standard accessories and protective devices as described below but not limited to:

- (1) Overload and short circuit trip for D.G. Set.
- (2) High temperature for cooling water trip if required
- (3) Alarm in case the D.G. set is not run for one week at a stretch
- (4) Earth fault
- (5) Reverse power relay
- (6) Low battery voltage
- (7) Fuel low level alarm
- (8) High lube oil temperature
- (9) Over speed

(7) Silencer Unit

Specially designed heavy duty residential type low noise silencer meeting the sound pollution norms of CPCB-II or latest. Exhaust pipe shall be wrapped with asbestos/ mineral wool and aluminium cladding.

(8) Emission Related Parameters

Emission Related Parameters should be in accordance with Central Pollution Control Board norms as applicable at the time of supply.

(9) Alternator

The alternator shall be self-exciting brush less technology, copper wound, self-regulating with screen protected enclosure suitable for feeding 400 V, 3 phase, 4 wires, 50 Hz AC supply with neutral point brought out. The alternator shall conform to BS: 5000 / IS: 4722 and winding shall conform to class 'H' / 'F' insulation. Alternator shall be provided AVR and of Voltage regulation within (+ 1%) of the rated voltage from no load to full load and permissible over load of 10% for one hour in 12 hours operation.

(10) Automatic Main Failure Panel (AMF Panel)

The AMF Panel shall be capable of starting the Diesel Generating set in the event of main power supply failure or low voltage below the specified value and changeover to load from main supply to DG set. The AMF Panel shall be connected and provided with suitable interlocking arrangements to avoid incident of paralleling of normal supply to the Generator Set.

(11) Arrangement

The engine shall be directly coupled to the alternator through flexible coupling and both the units including the radiator shall be mounted on a rigid fabricated bed plate. Base plate shall have threaded holes for holding down bolts for mounting engine and alternator. All the equipment shall conform to latest version of IS Specification including:-

- (a) Indian Electricity Act 2003 & Rules framed there under

- (b) BS: 5514 / IS: 10000 I.C. Engine
- (c) BS: 2613 / IS: 4722 Electrical performance of rotating electrical machines
- (d) BS: 1271 – Classification of insulating materials
- (e) IS: 13947 – Circuit Breaker

(12) Tests

The generating sets shall be tested at the maker's works in presence of nominated representative for:

- (a) Guaranteed fuel consumption
- (b) Over Load Capacity
- (c) Proper operating protective devices provided for safety of the generating set and AMF Panel

(13) Acoustic Enclosure

Requirement shall be as per technical details furnished here under:-

- (a) The acoustic enclosure shall be made of 14 SWG CRCA sheet.
- (b) The enclosure shall be powder coated (inside and outside) with a special pure polyester based powder. All nut and bolts/ external hardware shall be made from stainless steel.
- (c) The doors shall be gasketed with high quality gaskets to prevent leakage of sound.
- (d) Noise level should not be more than 75 dB at 1 meter distance.
- (e) Air Temperature inside enclosure shall not exceed beyond 70° C.
- (f) Weatherproof, Sound proofing of the enclosure shall meet the CPCB-II norms or the latest and shall be done with high quality rock wool/ mineral wool conforming to IS: 8183. The rock wool shall be further covered with fiber glass tissue and perforated sheet.
- (g) A special residential silencer shall be provided within the enclosure to reduce exhaust noise.
- (h) There shall be a provision of emergency shutdown from outside the enclosure.
- (i) Satisfactory operation at 50°C ambient.
- (j) Insulation material shall conform to UL94HF1 class for flammability.
- (k) Use of zinc plating with green passivated hardware to withstand salt spray test as per ASTM B-117.

The DG Set shall conform to environmental and noise pollution norms of Central Pollution Control Board.

11.3 TESTING AND COMMISSIONING

- (1) After installation, the DG set shall be rated for continuous application duty and shall be tested successfully for a period of 12 hours on the full load/ rated Capacity including One hour on 10% over load after continuous run of 12 hours at full load/

rated Capacity in terms of IS 10000 Part IV, 1980. All consumables including fuel lube oil and load banks required for commissioning the DG set shall be supplied by the Contractor. Test readings together with an hourly log of the running test shall be furnished to the Engineer.

- (2) Any abnormal condition occurring during trial run of the DG set shall also be recorded. Test results shall be recorded at 30 minutes intervals. Test proving the satisfactory performance of all operating gear, safety functions and controls shall be carried out.

11.4 EARTHING

Transformer neutral, DG set, UPS and Solar System shall have dedicated earth system as per IS; 3043.

(End of Chapter-11)

CHAPTER 12- FIRE DETECTION AND ALARM SYSTEM

12.1 GENERAL

- (1) A study shall be conducted by the contractor to identify the Fire hazards, analysis and mitigation measures. Fire detection scheme shall be developed and submitted for the approval of Engineer.
- (2) Fire detection and alarm system for the stations buildings & other buildings shall be as detailed below:
 - (a) Fire detections and alarm System shall be provided in equipment rooms of Station Buildings & IMSD, Control Room Buildings of TSS, SSP, Auxiliary substation, additional DG room, Signal Equipment Rooms, Telecom Equipment Room and S&T Power Supply Equipment Rooms for Signalling and Telecommunication works in Block Section at Auto Location Huts, GSM-R locations and Interfacing IR Station as required and additional buildings, if any for Signalling and telecommunication works over and above the SER, TER and S&T Power Supply Equipment Rooms in Station and Block Section. The Response indicator shall be placed outside on top of the entry doors. A 2-8 loop Fire alarm & control panel as required shall be housed in ASM room. Fire detectors used shall be intelligent analogue addressable type and shall conform to NFPA-72 standards.
 - (b) Fire Alarm & Control Panel (FACP) along with alarm or hooter shall only be provided in ASM room or any other identified location as confirmed by The Engineer.
 - (c) The Fire Detection & Alarm System shall be designed, installed, verified, tested, and commissioned to the requirements of respective NBC 2005 Part-IV standards/NFPA-72 standards and NFPA 130 at stations.
 - (d) All these works shall also be in conformity to the statutory requirement of respective area Fire Service practices for which necessary clearance shall be obtained.

12.2 FUNCTIONAL REQUIREMENT

- (1) The main purpose of the installation of a fire detection and alarm system at stations and other service buildings is to detect a rising fire in its early stage, to take counter measures immediately, and thus prevent the spread of fire and protect life and property from severe damage, and maintaining the operation of the building and its services provided with necessary communication port and software as needed.
- (2) The Fire Alarm System shall be ready fit to tie-up with the Auxiliary/ Traction SCADA, Local Control and Mimic Panel into an Integrated System.
- (3) The Fire Alarm System shall conform the National Building Code of India.

12.2.1 Fire Alarm & Control Panel (FACP)

- (1) **Component**
 - (a) The Fire Alarm & Control Panel shall function as fully stand – alone panel as well as providing a communication interface to the central station. FACP

shall have its own microprocessor, software and memory and should be listed under UL. The FACP shall be capable of accepting up to 2-8 fire loops as required.

- (b) FACP shall provide general purpose inputs for monitoring such functions as low battery or AC power failure. FACP shall provide tamper protection and command able outputs, which can operate relays or logic level devices. Smoke detectors shall be powered using the FACP-based smoke detection circuits. FACP shall provide for resetting smoke detectors, fault-isolation and sensor loop operation. The following (LED) indicators or RED LCD as approved by the Engineer and control switches shall be provided on the panel:

(i) Indicators:

- System ON
- System Fault/Failed
- Battery ON
- Alarm Condition (supported by Buzzer/ hooter)
- Trouble Condition.

(ii) Control switches as approved by the engineer:

- Reset
- Alarm acknowledge
- Alarm silence
- Trouble silence
- General alarm (evacuation)
- Lamp test

12.3 POWER SUPPLY

12.3.1 Power Supply Unit

The power supply unit of FACP shall have the following characters:

- (1) The main power supply shall be 230 V AC, 50 HZ and shall in turn provide all necessary power to FACP.
- (2) FACP shall be provided with a battery charger for 24 hrs for standby power using dual-rate charging technique for Trickle, Boost and float Battery charging. Contractor shall provide Maintenance free lead-acid battery as approved by the Engineer.

12.3.2 Initiating Devices

(1) Heat Detectors

- (a) Automatic heat detectors shall be of the analogue addressable type using the latest algorithm principles for accurate indication of normal condition, pre-alarm and alarm indications.
- (b) The heat detectors shall be of the combination, fixed and rate-of-rise

sensors. The fixed temperature setting shall be 72°C and rate-of-rise temperature setting shall be 9°C (15°F) per minute.

- (c) The detectors shall comply with the applicable requirements of UL 521 and shall be resettable type.

(2) Smoke detectors

- (a) Automatic smoke detectors shall be of the intelligent analogue addressable type, using the latest algorithm principles for accurate indication of normal condition, pre-alarm and alarm indications, complete with plug-in base and auxiliary contacts.
- (b) The smoke detectors shall be of the photo-electric type which operates on the light scattering principle utilizing a solid-state infrared LED and high speed, light sensing photo diode within its sensing chamber to detect visible products of combustion.
- (c) The detectors shall comply with the applicable requirements of UL 268.

(3) Manual Actuated Alarm-Initiating Devices (Manual Stations)

- (a) The manual station shall consist of a push button switch housed in a dust tight sheet steel enclosure of minimum 1.5 mm thick sheet to manually initiate audio-visual alarms. The front shall be sealed with a breakable glass cover fixed in such a way that the actuating push button is kept depressed as long as the glass is intact and released automatically when the glass is broken.
- (b) The Manual stations shall comply with the applicable requirements of UL 38.

(4) Combined Optical Smoke & Heat Detector

The detector shall operate on light scattering principle, containing an emitter and photo sensor. The scattered light reaching the photo sensor shall be proportional to the smoke density inside the detection chamber. It shall combine both optical and heat detector technology to detect clear burning fire products, which hitherto could only be easily detected by ion-chamber detectors. The detectors shall not operate on a rate of rise of temperature alone. It shall meet the UL standard. The detector shall be fully operable between -20°C and +70°C and up to 95%relativehumidity non-condensing. The Combined Optical smoke & Heat detectors shall be installed in the most areas.

(5) Isolator Module

Isolator modules shall be provided to automatically isolate wire-to-wire short circuits on loop. In stations, the alarm (hooter) may be placed in the station master room.

(6) Hooter/ buzzer:

The FACP on detection of the Fire hazard as noticed by the detector shall activate the requisite enunciator/ hooter or Buzzer.

(7) Response Indicator

Response Indicator shall be provided outside the unmanned/ locked areas / room. The Response Indicator shall glow clearly in case the detector to which it is connected gives an alarm signal. The word "FIRE" shall be clearly written on the visible face of the box. There shall be two numbers of red LEDs to compensate for

fusing of either LED.

The Response Indicator shall also have the words "ROOM" or "ABOVE FALSE CEILING" screen printed on it, as the case may be RI should be separate for each level i.e. detectors in false ceiling, flooring should not be provided with common RI.

12.3.3 Conduit and Wiring

Main control wiring loop shall be twisted with shield Fire Survival (FS) Cable and wiring shall not be less than 1.5 mm² FS Cable for initiating devices and 2.5 mm² FS Cable for alarm indicating devices and run in conduits. The number of wires and size of conduits shall be in accordance with the manufacturer's recommendation or as shown on the drawings. Supply and return lines for initiating devices must be in separate conduits or raceways.

12.4 TESTING AND COMMISSIONING

- (1) These shall prove that:
 - (a) All equipment cabling and distribution is electrically and mechanically safe.
 - (b) All cables, cores and terminations are properly made off, secure, properly supported and correctly identified and coloured.
 - (c) All phases, polarities, neutral and common connections are correctly switched as required, that power is correctly available at all points and that voltage and frequency at all equipment is correct and in accordance with the requirements for correct working.
 - (d) All supplies are properly provided with fuse, or otherwise protected to give satisfactory discrimination and safe disconnection under fault conditions.
 - (e) Batteries are properly ventilated, installed, connected and fitted, and that battery chargers are working correctly.
 - (f) Insulation resistance of all cabling and equipment is not less than that required by the requirements of the appropriate Statutory Authorities.
 - (g) All instruments and meters are energized with the correct polarity and working properly.
 - (h) All fault indications and alarms are working correctly.
 - (i) All essential equipment fed from battery systems continues to function correctly and without disturbance during all supply failures, restoration and standby sequences.

12.4.1 Additional Tests

- (1) Additional tests shall be performed to verify that the complete electrical installation shall meet the requirements of this Specification. The list provided below is indicative of the minimum tests required.
 - (a) **Cables**
 - (i) Continuity Test
 - (ii) Insulation Resistance Test
 - (iii) Earth Test
 - (iv) Polarity Test

- (2) The Fire Detection & Alarm Systems shall be tested in accordance with NFPA 70 & 72. Each component and assembly shall be type tested and functionally tested before installation, and the entire system functionally tested for correct operation including all interfaces with the other systems.
- (3) Minimum required tests are as follows:
 - (a) Test initiating and indicating circuits for proper signal transmission under open circuit conditions. One connection each shall be opened at not less than 10 percent of the initiating and indicating devices. Observe proper signal transmission according to class of wiring used.
 - (b) Test each initiating and indicating device for alarm operation and proper response at the control unit. Test smoke detectors with actual products of combustion.
 - (c) Test the system for all specified functions according to the approved operation and maintenance manual. Systematically initiate specified functional performance items at each area, including making all possible alarm and monitoring initiations and using all communications options.
 - (d) Complete testing of automatic and manual fire alarm system.

(End of Chapter-12)

CHAPTER 13 – FIRE SUPPRESSION SYSTEM

13.1 GENERAL

The Contractor shall assess the fire risks & hazard, calculate the fire load and design, supply, install, test and commission the fire suppression system as per application duty requirements and the local Fire Regulations as under:

- (1) Portable Fire extinguishers as per the clause no. 13.3 of this specification.
- (2) Fire trace tube system for panels as applicable.

13.2 CODES AND STANDARDS

The latest editions of the following codes, specification and regulations shall be followed for the detailed design and provision of Fire suppression system:

- (1) NFPA 10, 13 & 14: 2001: as relevant and latest
- (2) SMPV Rules, PESO (For storage cylinders)
- (3) Clean Agent manufacturer's recommendations as applicable
- (4) National Building Code 2005

13.3 PORTABLE FIRE EXTINGUISHERS

- (1) The Portable Fire Extinguishers shall be provided at Station building (in equipment rooms viz. D.G. cum Solar room, battery rooms, IPS room, station control / ASM / Panel rooms, power supply and equipment room, switch room, SER & TER), Auxiliary Substations, additional DG Room, Control Room building of TSS/SSP, and at IMSD depots(in power supply room, covered sheds, offices, stores and stairs etc. as applicable).
- (2) The type, location and quantity of extinguishers shall be appropriate for the risk and shall be got approved from the Engineer.
- (3) In addition to the above, based on the assessment of fire hazard, fire load calculation, Portable fire extinguishers shall be provided by the Contractor at strategic locations as approved by the Engineer.
- (4) Portable fire extinguishers shall be compliant to NFPA 10 standard and suited for electrical equipment fires.
- (5) In Signalling & Telecom Equipment Rooms at Station, Depot (IN OFC equipment Telephone exchange) and Signalling & Telecom rooms in block section, Portable Fire Extinguishers shall be provided.

13.4 FIRE BUCKETS

GI fire buckets filled with dry sand including hanging arrangements for buckets, manufactured with MS angle of appropriate size/section shall be provided on specified locations as under:

- (1) Auxiliary substations;
- (2) Additional room for D.G. set;

- (3) Electrical Installations at Stations and depots; and
- (4) Control Room building (TSS/SSP) as described in Volume-2, PS for Electric traction and associated works.

(End of Chapter-13)

CHAPTER 14-EARTHING, BONDING AND LIGHTNING PROTECTION SYSTEM

14.1 GENERAL

- (1) The Contractor shall supply, install, connect, test and commission a complete system of safety grounding and lightning protection in accordance with the Drawings and specifications herein.
- (2) All the non-current carrying metal parts of electrical installation shall be earthed properly. All metal conduits, cable trays, trunking, cable sheaths, switchgear, distribution fuse boards, light fittings and all other parts made of metal shall be bonded together and connected by means of specified earthing conductors to an efficient earthing system.
- (3) Earthing System shall be required at locations at the Auxiliary Sub-station, buildings, depot at all Equipment room including provision of main earth terminal in equipment rooms.

14.2 APPLICABLE STANDARDS AND CODES

The **Earthing System** shall also conform to the following:

- (1) TNS earthing system shall be followed
- (2) It shall comply with Indian Electricity Rule 1956, National Building Code, and railway Guidelines
- (3) IEEE 80: 2000 Guide for safety in AC substation
- (4) IEEE 81: Guide for measuring Earth Resistivity, Ground Impedance and Earth Surface Potentials of a ground system
- (5) Earthing practices as laid down in CPWD specification for Electrical Work Part-1 Internal 2005 shall be referred
- (6) The material used for earthing shall preferably be UL listed

14.3 MATERIAL DESCRIPTION

- (1) The material for earthing and lightning protection system shall consist of ground rods with pits, ground conductors, test boxes, lightning down conductors, lightning conductors, air terminals and accessories interconnected for the complete system.
- (2) The earthing system is primarily of G.I. and the earthing configuration is Indian TN-S as per IS: 3043 – 1987. The Contractor shall ensure that the intents of the earthing configuration are met with, by providing a single-phase-ground fault current, sufficient enough to trip all the circuit breakers and fuses in the system.

14.4 CRITERIA

Earthing and bonding shall accomplish the following requirements:

- (1) Protect personnel and equipment from electrical hazard
- (2) Achieve a reduction in potential to the system neutrals

- (3) Keep the step and touch potential within safe limits and prevent possibilities of voltage rise to ensure faults are cleared by circuit protection

14.5 LIGHTNING PROTECTION SYSTEM

- (1) Protection of building against lightning shall be done in accordance with IS: 2309-2005, IEC 62305, NFPA 780 and include the provision of a parallel path lightning protection system complete with air terminal conductors, ground terminals, interconnecting conductors & other fittings required for the complete system.
- (2) The procedure for lightning protection system shall be as laid out at General Specifications for Electrical Works Part-1(Internal)-2005 issued by CPWD, Chapter- 9.
- (3) Lightning detection and protection system should be as per the requirements of the National Building Code of India 2005.

14.6 INSTALLATION

All equipment shall be installed& earthed at the locations conforming to the standard as specified. The Earthing system installed shall conform to the requirement of IEEE:80-2001 including the chemical treatment of the soil as required.

14.7 TESTING AND COMMISSIONING

Following Earth resistance values shall be measured with an approved earth megger and recorded:

- (1) Each earthing station
- (2) Earthing system as a whole
- (3) Earth continuity

The measured values should be within the limit as specified in the relevant standards.

(End of Chapter-14)

CHAPTER 15- AIRCONDITIONING & VENTILATION SYSTEM

15.1 GENERAL

- (1) The contractor shall assess the Air-conditioning & Ventilation requirement to maintain the requisite working temperature range and provide Air-conditioning system for the following installations:
 - (i) Station Manager/ SM room, Signalling and Telecom Equipment rooms at the Station;
 - (ii) Officer Rest room and Inspector Rest Room at Stations;
 - (iii) Telecom Equipment Room in Block Sections at Auto Location Huts, GSM-R locations, interfacing IR station and at the TSS.
- (2) The system shall be designed and provided with N+1 standby Air-conditioners for a 24 hour application duty requirement.
- (3) Mechanical ventilation shall be provided for the stair, toilets, equipment rooms, power supply room (ASS), additional DG room at Stations, Depots, Control room building(TSS/ SSP)and at specific location of staff quarters, etc as required.

15.2 STANDARDS & CODES

The applicable Standards/Codes are:

- (1) American Society of Heating, Refrigeration and Air-conditioning Engineers (ASHRAE)
- (2) National Building Codes
- (3) American Heating and Refrigeration Institute (AHRI)
- (4) Indian Society of Heating Refrigerating and Air-Conditioning Engineers (ISHRAE)
- (5) Weather Data and design Conditions for INDIA published by Indian Society of Heating Refrigerating and Air-Conditioning Engineers (ISHRAE) and India Chapter of ASHRAE

15.3 BASIS OF DESIGN

- 15.3.1 The contractor shall submit heat load calculations for approval based on finalized building drawings. The building shall have double glazed windows and under deck insulation below the top floors / floors exposed to external heat / cold. The system shall be such so as to be most efficient in terms of performance and electricity consumption.
- 15.3.2 The contractor shall provide the requisite capacity air-conditioning system to achieve the Room temperature of 21 +/- 2 Degree Celsius at highest climatic/ ambient conditions.
- 15.3.3 The air-conditioning system shall be designed for continuous application Duty at Highest ambient without any de-rating in the performance standards.
- 15.3.4 The air-conditioning system shall be provided with clean refrigerant only as per the latest standard

15.3.5 The ventilation shall be provided as per the type of Buildings conforming to Nation Building Code.

15.4 AIR-CONDITIONING SYSTEM PERFORMANCE REQUIREMENT

- (1) The air-conditioning shall be designed as per the Outdoor & Indoor Design Conditions conforming to ASHARE Guidelines. Site conditions shall be as specified in GS.
- (2) Fresh Air: Adequate fresh air quantity shall be provided to air-conditioned spaces to maintain indoor air quality (IAQ) generally as per ASHRAE standard 62.1-2005.
- (3) Lighting Load, Equipment heat Load and Occupancy shall be as confirmed by the Engineer.

15.5 AIR CONDITIONING AND VENTILATION BY THE CONTRACTOR AT STATIONS, IMD AND IMSDS AND CONTROL ROOM BUILDING

15.5.1 The Air-conditioning system shall be provided at location as mentioned in para 15.1

15.5.2 The contractor shall assess the Air-conditioning tonnage required for each area and submit a detailed calculation Sheet to the engineer for approval. Contractor shall provide the air-conditioners of required capacity as approved by The Engineer.

(End of Chapter-15)

CHAPTER 16 - SOLAR POWER SYSTEM

16.1 GENERAL

The specification covers general and technical requirements for design, manufacturing, testing, supply, installation and commissioning of Grid connect solar generating system to be provided at station and IMSD. The grid connects solar photovoltaic system (SPV) shall be provided as under:

- (1) Station: 5 KW for Junction Station Solar Energy Generation.
- (2) Depot (IMSD): 1 KW of Solar Energy Generation

16.2 SYSTEM DESCRIPTION

Solar Photovoltaic (SPV) grid connects system shall consist of mainly the following: -

- (1) Solar panels
- (2) Module mounting structure
- (3) Junction boxes
- (4) Power conditioning unit (PCU)
- (5) Import & Export metering
- (6) Cable and other accessories

16.2.1 The PV array converts the light energy of the sun to DC power. The module mounting structure shall be used to hold the PV module in position. The DC power shall be converted to AC by PCU to supply AC loads within the premises. Solar power shall be integrated with the premises power supply from electricity authority.

16.2.2 DC distribution board/ combiner shall be provided in between solar array and PCU. It shall have DC Dis-connector switch /MCCB of suitable rating for connection and disconnection of array section. Type II Surge Arrestor should be incorporated for surge protection. It shall have meters for measuring the array voltage and array current.

16.2.3 AC distribution board shall be provided in between PCU and loads. It shall have an integrated energy meter, voltmeter and ammeter. Class I + II (as per IEC 62305) 100 kA Surge Arrestor should be incorporated for protection against surges.

16.3 GENERAL REQUIREMENTS

16.3.1 Solar generating system shall supply part/ full load of railway service buildings/ areas.

16.3.2 The PV system shall reduce the electric energy units drawn by railway from the grid and thereby reduce IR's CO₂ emissions.

16.3.3 Solar panels and array junction boxes shall be installed on shade free roof while the PCU/ grid tie string inverter and distribution boards, etc. shall be housed inside the room provided for this purpose.

16.3.4 Array structure of PV yard and all electrical equipment such as PCU, inverters, etc. shall be grounded properly. The contractor shall supply and install adequate number of earthing Pits; at least one each for AC circuit, DC circuit and lightning protection system in compliant of IS: 3043-1987.

- 16.3.5 Suitable marking shall be provided on the bus for easy identification.
- 16.3.6 PV modules may be connected in series up to the maximum allowed operating voltage of the PV modules and the PV inverter, whichever is lower.
- 16.3.7 The reverse current of blocking diodes (connected in series) used shall be rated for 2 X VOC STC of the PV string.
- 16.3.8 Proper sealing arrangements at the points of cables entering the enclosures/ buildings should be incorporated. The cables entering into the enclosures/building shall be sealed with modular EPDM based cable sealing and protection system based on multi-diameter technology as recommended by the manufacturer.

16.4 TECHNICAL REQUIREMENTS

- 16.4.1 The DC output from the modules shall be fed to array junction box and the strings are paralleled at sub Main & Main junction boxes. Then Power Conditioning Unit shall convert DC energy produced by the solar array to AC energy. The AC power output of the inverter shall be fed to the AC distribution board (metering panel & isolation panel), which also houses the energy meter. The AC output of grid-connect SPV system should be paralleled with normal electric power supply (power supply received from the electricity authority).
- 16.4.2 When the grid voltage and/or frequency goes out of preset range, the inverter shall be immediately disconnected from the grid. The inverter shall reconnect after a pre-determined time when the grid is back in the range.
- 16.4.3 Array to inverter voltage drop shall be less than 3% at the maximum power output of the array.
- 16.4.4 For safety reasons, PV inverter system shall be disconnected from the network following a fault or loss of supply on the power network.
- 16.4.5 The performance and generation data shall be recorded using a data logger. The monitoring system shall comprise of the following main components.
- (1) PCU shall log the inverter performance data and transmit the same to the data logger. It shall also monitor basic parameters like power generated, etc.
 - (2) Data logger shall gather information and monitor the performance of the inverter. It shall also support measurements from the external sensors. Data Logger shall also monitor the Solar Insulation and Temp of Arrays.
 - (3) Data logging system/software shall enable automatic long-term storage of measured data from PV plant. It shall allow visualization, monitoring, commissioning and service of the installation. The data logger shall integrate with SCADA system. It should also be possible to retrieve the data directly from the data logger. The software for access/ visualization of data from data logger shall be provided by the supplier. Necessary executable files, if any, shall be required to be given by the contractor on a CD/any other storage device.
 - (4) **Communication interface**
The system should offer RS232/RS485 port and LAN/ WAN interface to facilitate remote monitoring of the system.
- 16.4.6 **SPV Module**
- (1) Individual Solar PV Module should be of minimum capacity 230 WP conforming to

IEC: 61215 Ed 2 or latest - Edition II, IEC: 61730 - I: 2007, IEC: 61730 - II: 2007, manufactured in a plant certified under ISO 9001: 2008 and type tested by an accredited national/international testing laboratory. The Solar 1W Module should be made from mono/poly crystalline Silicon Solar Cell connected in series. Cut cells should not be used.

- (2) SPV modules of similar output with $\pm 5\text{WP}$ tolerance in single string shall be employed to avoid array mismatch losses.
- (3) SPV module shall contain crystalline high power silicon solar cells. The solar cell shall have surface anti-reflective coating to help to absorb more light in all weather conditions.
- (4) Photo-electric conversion efficiency of SPV module shall not be less than 14%.
- (5) Fill factor of the module shall not be less than 72%.
- (6) Each module shall have low iron tempered glass front for strength and superior light transmission. It shall also have tough multi-layered polymer back sheet for environmental protection against moisture and provide high voltage electrical insulation. Transitivity of glass shall not be less than 91%.
- (7) Module junction box and terminal block (weather resistant) shall be designed for long life outdoor operation in harsh environment.
- (8) Bird spike shall be provided so as to avoid bird sitting on the solar modules at the highest point of the array/module structure.
- (9) SPV module shall be highly reliable, light weight and shall have a service life of more than 25 years. SPV modules shall have a limited - power loss of not more than 10% of nominal output at the end of 10 years and of not more than 20% of nominal output at the end of 25 years.
- (10) The output of any supplied module shall not be less than the rated output and shall not exceed the rated power by more than 5 Wp. Each module, therefore, has to be tested and rating displayed.
- (11) Whenever more than one module is required, identical modules shall be used.
- (12) The module shall perform satisfactorily in relative humidity upto 95% and temperature between -10°C and $\pm 85^{\circ}\text{C}$.
- (13) The solar modules shall have suitable encapsulation and sealing arrangements to protect the silicon cells from the environment. The encapsulation arrangement shall ensure complete moisture proofing for the entire life of solar modules. The terminal block shall be preferably of Noryl rubber with weatherproof design (minimum IP 66) and shall have a provision for opening /replacing the cables if required.
- (14) Insulation Resistance of the module shall not be less than 50M-ohm when measured with a 500V DC megger.
- (15) The Contractor shall furnish a Calculation supported by a simulation to demonstrate the proper sizing of Solar Power Module and the other components.
- (16) Selection of SPV modules shall be made on the basis of the output which shall not be less than 99.5%.

16.4.7 **Module Mounting Structure**

- (1) The array structure shall be so designed that it shall occupy minimum space

without sacrificing the output from SPV panels.

- (2) The structure shall be designed to allow easy replacement of any module and shall be in line with the site requirements.
- (3) The array structure shall be made of hot dipped galvanized MS angles of suitable size. Galvanization thickness shall be of min. 85 micro-metre.
- (4) The foundation for module mounting structure shall be preferably 1:2:4 RCC constructions or any other combination based on the local site condition requirement for which design details shall be submitted. The weight of the structure should be considered while designing the building and the water proofing should not be damaged.
- (5) The support structure, design and foundation shall normally be designed to withstand wind speed upto 150 kmph or higher as may be encountered in the Dadri - Khurja section.
- (6) The clearance between lowest part of the module structure and the developed ground level shall normally not be less than 500mm. However, in exceptional cases, lower clearances may be allowed on case to case basis.
- (7) The module alignment and tilt angle shall be calculated to provide the maximum annual energy output. This shall be decided based on the location of array installation.
- (8) In general, bolt, nuts, shims and other hardware should be zinc plated. Fasteners visible to the public shall generally be of austenitic stainless steel SS-304. The generally applicable engineering principle shall be that fasteners shall be equal to or of greater corrosion resistance than the most corrosion resistant metals being fastened.
- (9) The array structure shall be designed with arrangement of rotation of frame / tracking control so that PC Cells face towards the sun during the day for 1KW and above rating.

16.4.8 Junction Boxes

- (1) The module junction box (if any) shall be certified as per IEC 61215. Else, they should have the same properties as mentioned for array junction boxes. Array sub-main and main junction boxes, shall have the following properties:
 - (a) They shall be dust, vermin & waterproof and made of Polycarbonate-Glass Fibre Substance (PC- GFS) thermoplastic. The enclosure should be double insulated.
 - (b) The enclosure shall have a transparent front lid for enabling easy visibility.
 - (c) The enclosures shall have IP 66/67 protection in accordance with IEC 60529.
 - (d) Minimum requirements for fire protection in the event of internal faults: Glow wire test in accordance with IEC 60695-2-11 at 960°C for box and 850°C for conducting components.
 - (e) Burning Behaviour: Base part of Polycarbonate Enclosure shall be UL94-V-0 compliant and Lid part of PC Enclosure shall be UL94-V-2 compliant.
 - (f) The enclosures shall have IK 08 degree of protection for mechanical load.
 - (g) The material used shall be halogen, silicon free conforming to RoHS

directive 2002/95/BC.

- (h) The enclosure shall have a usage temperature rating of - 10°C to 55°C.
- (i) The enclosure should be chemically resistant to acid, lye, petrol, mineral oil & partially resistant to benzene.
- (j) The enclosures shall have a rated insulated voltage of 1000V DC and dielectric strength of 4.65 kV DC.
- (k) The material of the enclosure shall be UV stabilized.
- (l) Breather glands in the array junction boxes to prevent overheating and explosions are to be provided.
- (m) SPDs Class II as per IEC 61643-1, shall be used at the terminals of array junction boxes for external surge protection. Internal Surge protection (SPDs) shall consist of three MOV type arrestors connected from (+ve) and (-ve) terminal to earth (Via Y arrangement) for higher withstand of the continuous PV-DC voltage during earth fault condition. SPD shall have safe disconnection & short circuit interruption arrangement through integrated DC in-built bypass fuse (parallel) which should get tripped during failure mode of MOV, extinguishing DC arc safely (created by inbuilt thermal disconnection) in order to protect the installation against fire hazards. Nominal discharge current (In) at 8/ 20 microseconds shall be minimum 10 MA with maximum discharge current (Imax) of minimum 20 MA at 8/20 microseconds with visual indication (through mechanical flag) in all modules to monitor the life of SPD. The Iscwpv (Short Circuit current withstand capacity of arrester) would be at least 10% more than Nominal output current of the combiner box and AJB. Detailed internal schematic for the above SPDs, compliant to these specifications, should be submitted.

16.4.9 Earthing for PV array, Balance of System (BOS), lightning protection and other components.

- (1) The photovoltaic modules, Balance of system (BOS) and other components of power plant require proper grounding for protection against any serious faults as guided by IEC 60364.
- (2) The earthing resistance must not exceed the limits generally in practice for such applications.
- (3) The contractor shall submit the detailed scheme of earthing and grounding.
- (4) The contractor shall supply and install an adequate number and appropriate size of IS:3043 - 1987 compliant earthing kits; at least one each for AC circuit, DC circuit and lightning protection system.
- (5) Lightning protection should be provided as per IEC 62305.
- (6) The lightning conductor and structures shall be earthed through flats as per applicable Indian Standards with earth pits. Each lightning conductor shall be fitted with individual earth pit as per required Standards including accessories, and providing masonry enclosure. Else, a matrix of lightning conductors is to be created which shall be required to be connected to an earth.
- (7) If necessary, more numbers of lightning conductors (connected in parallel) may be provided.
- (8) The contractor shall submit the drawings and detailed specifications of the PV

array lightning protection equipment.

16.4.10 Power Conditioning Unit (PCU)

- (1) PCU shall supply the DC energy produced by array to DC bus for inverting to AC voltage using its MPPT (Maximum Power Point / Tracking) control to extract maximum energy from solar array and produce 400V (+15% and -20%) AC, 3 phase, $50 \pm 5\%$ Hz (47.5 to 52.5 Hz) to synchronize with the local grid. The array output should be well within the input voltage range of the inverter so that the inverter works in MPPT range for most of the solar insolation range. This should be applicable for the whole life of the solar array and needs to be substantiated through design calculations. PCU should be able to handle maximum open circuit DC voltage of 1,000V.
- (2) MPPT controller, inverter and associated control and protection devices, etc. all shall be integrated into the PCU. The inverter must have a minimum of two independent MPPT channels inbuilt.
- (3) PCU string inverter shall provide 3 phase, 400V (with grid tracking of +15%/-20%), 50 Hz (with grid tracking of $\pm 5\%$ i.e. 47.5 to 52.5 Hz) supply on AC side with voltage THD of less than 3% and current THD of less than 5%.
- (4) Efficiency of PCU with transformer shall not be less than 92% for systems from 5 KWP to less than 30 KWP, 93% for systems from 30 KWP to less than 50 KWP. For transformer-less design, it shall be minimum 96%.
- (5) Degree of protection shall be minimum IP20 for non-electronics portion where transformer, etc. are mounted, if any. All outdoor electronic equipment/ components shall be of IP65.
- (6) The inverter shall be efficient with IGBT based reliable design. The control system should be of highest reliability preferably based on Digital Signal Processors. Though not mandatory, the manufacturers are encouraged to provide the control system of redundant type.
- (7) The PCU shall be capable of complete automatic operation, including wake-up, synchronization and shut down.
- (8) PCU shall have the facility to display the basic parameters of the system on a typical 4 line by 20 characters type LED/LCD display. Displays of a bigger size can also be provided. The inverter must have a dry contact output for remote indication of inverter status. The inverter should have a dry contact input for disabling the inverter remotely.
- (9) PCU shall be able to synchronize independently and automatically/ phase-lock with POWER SUPPLY AUTHORITY grid power line frequency to attain synchronization.
- (10) Built-in data logging to monitor plant performance through external PC shall be provided.
- (11) Inverter shall be tested for islanding protection performance.
- (12) Only isolated inverters shall be grounded on DC side.
- (13) The inverter should be CE marked for the Low Voltage Directive according to IEC 62109-1 / IEC 62109-2, AS3100, for electrical safety.
- (14) The inverter should be certified to comply to the following grid interconnection standards – BDEW, VDE0126-1-1, VDE-AR-N 4105, RD1663, RD661, RD1699,

ENEL-Guide, CEI 0-21, A70, G59/2, UTE C15-712-1, AS4777/SI4777, PO12.3, IEC 62116, IEC 61727.

- (15) The inverter should be tested for power conversion efficiency as per IEC 61683:1999 / EN 61683:2000.
- (16) The inverter should be CE marked for the EMC directive 2004-108-EC and should comply to EN 61000-6-2.

16.4.11 **Indications (through LEDs/ LCD display)**

Following is an indicative list of indications (the actual scheme shall be finalized at design stage):

- (1) Inverter ON
- (2) Grid ON
- (3) Inverter under voltage/over voltage
- (4) Inverter over-load
- (5) Inverter over-temperature
- (6) Daily Run time
- (7) DC Input Voltage, Current & Power, per MPPT channel
- (8) Output Voltage, Current, Frequency, Power & Power Factor
- (9) Inverter Status
- (10) Energy Harvested Daily
- (11) Energy Harvested for the Month
- (12) Energy Harvested for the year
- (13) Total Operation Time
- (14) Total electricity generated
- (15) Earth Fault

16.4.12 **Protections**

- (1) Following is an indicative list of protections (the actual scheme shall be finalized at design stage):
 - (a) Over-voltage both at input and output
 - (b) Over-current both at input and output
 - (c) Over/under grid frequency
 - (d) Over temperature
 - (e) Short circuit on AC side
 - (f) Reverse polarity protection
 - (g) Array ground fault protection
 - (h) Protection against lightning induced surges Class II, 10 kA as per IEC 61643-1
 - (i) Protection against surge voltage induced at output due to external source
- (2) Night consumption of the PCU shall be less than 0.2% of the KW rating of the

inverter for system capacities of 25KWP or more. It shall be less than or equal to 50W for system capacities of less than 25KWP.

- (3) Noise level of the PCU should be less than 65 dBA (nominal) at 1m.
- (4) DC insulation resistance should be more than 50MΩ.
- (5) EMI and EMC Requirements: PCU shall comply the following EMI and EMC requirements:
 - (a) Emitted interference as per IEC: 61000-6-4
 - (b) Interference emitted as per IEC: 61000-6-2
- (6) An integrated earth fault detection device is provided to detect eventual earth fault on DC side and shall send message to the supervisory system.
- (7) Idling current at no load shall not exceed 2% of the full load current.
- (8) PCU shall withstand high voltage test of 2,000 Vrms between either the input or the output terminals and the cabinet (chassis).
- (9) PCU includes ground lugs for equipment and PV array groundings. The DC circuit ground shall be a solid single point ground connection.
- (10) Where PCU hasn't been provided with galvanic isolation, a type B residual current device (RCD) according to IEC 60755 amendment-2 shall be installed to provide fault protection by automatic disconnection of supply. Inbuilt RCD shall also be accepted.
- (11) To allow maintenance of the PCU, means of isolating the PCU from the DC side and the AC side shall be provided.
- (12) PCU can be a combination of multiple string (10 to 20 KWp each) inverters depending on capacity of SPV.
- (13) The PCU should withstand the environmental tests (as per IEC 60068/ IS 9000) listed below with the PCU working at full load for at least last half an hour. For SPV systems of 10 KWP or higher capacity, environmental test results in respect of any similar design PCU for at least 10 KWP SPV systems shall be adequate and as defined below:
 - (a) Dry Heat Test: 50°C±2°C for 16 hours
 - (b) Damp Heat Test (Steady state): 40°C, 93% RH for 4 days
 - (c) Damp Heat Test (Cyclic): 40°C, 93% RH for 6 cycles (duration of one cycle shall be 24hrs)
 - (d) Cold Test: 0°C for 16 hours
 - (e) Change of temperature Test: -10°C/-5°C to 50°C for 3 cycles (rate of change in temperature shall be 3°C per minute)

16.4.13 Cables and Hardware

- (1) The cables used in module/ array wiring shall be TUV 2Pfg 1169/08.2007 or VDE EPV 01:2008-02 or UL4703 certified. Cables of appropriate size to be used in the rest of the system shall have the following characteristics: Temp. Range (-)10°C to (+)120°C.
- (2) Voltage rating 600/ 1000V

- (3) Excellent resistance to heat, cold, water, oil, abrasion, UV radiation, ozone and weathering
- (4) Halogen-free, low smoke, low toxicity
- (5) Flame retardant
- (6) Flexible
- (7) Fulfils IEC 60332-1 requirements. Accredited lab test report/Manufacturer's test report shall be attached.
- (8) Conductor class IEC 60228 class 5. Accredited lab test report/Manufacturer's test report shall be attached.
- (9) Cabling on DC side of the system shall be as short as possible to minimize the voltage drop in the wiring.
- (10) Components and hardware shall be vandal and theft resistant. All parts shall be corrosion-resistant.
- (11) Voltage drop on the DC side from array to the inverter should not be more than 3%. Necessary calculations in this regard shall also be submitted during design approval.
- (12) Overload protection may be omitted to PV string and PV array cables when the continuous current-carrying capacity of the cable is equal to or greater than 1.25 times $I_{sc}STC$ at any location. Necessary calculations in this regard shall be submitted during design approval.
- (13) Overload protection may be omitted to PV main cable if the continuous current-carrying capacity of the cable is equal to or greater than 1.25 times $I_{sc} STC$ of the PV generator. Necessary calculations in this regard shall be submitted during design approval.

16.4.14 **AC Distribution Board (ACDB)**

The ACDB must have the following features:

- (1) Cables connecting bus bar should be minimum 3 times capacity of Solar Power plant.
- (2) The Designated Load should be routed through ACDB and an Energy Meter to register the Load Energy Consumption from Solar and Grid during Week Days and Holiday.
- (3) ACDB should have Class I + II (as per IEC: 62305; IEC: 61643 and IEC: 60364-5-53), 100 kA Surge Suppression inbuilt for surge protection. Surge protection on AC side (Type 1 +Type 2) shall consist of Prewired metal encapsulated spark gap based solution for fire safe and fire proof operation at site, consisting of base part and plug in protection modules. Total discharge capacity/ Lightning Impulse current (Iimp) at 10/350 microseconds and nominal discharge current (In) at 8/ 20 microseconds shall be minimum 100 KA for three phase power supply system and 50 KA for single phase power supply system. The discharge capability of L-N connected module shall be 25 KA at 10/350 microseconds and 8/20 microseconds. All the LN & N-E connected arresters shall have built in mechanical health indication. Complete solution shall have voltage protection level (Up) of ≤ 1.5 KV to protect the sensitive electronics inside the Invertors, having follow current extinguishing and limiting capability up to 25 mA rms (at 255V) without tripping of even small rating 32 AOL/DO fuse and approved from international independent

test labs like KEMA or VDE or UL as per latest IEC 61643-1 or equivalent EN 61643-11 standard. SPDs on the ACDB shall be provided if the same haven't been provided on the PCU.

16.4.15 **Provision for Maintenance**

The Array Yard should have permanent Water Line with Butterfly valve and rubber hose so that cleaning can be done.

16.5 **INSTALLATION & COMMISSIONING**

- 16.5.1 The installation shall be done by the contractor for system performance, direction of installation and structural stability. The contractor shall conduct a detailed site assessment. The PV installer shall obtain data specific to the site, rather than relying on general data. While making foundation design, due consideration shall be given to weight of the module assembly, maximum wind speed at the site etc.
- 16.5.2 The SPV panel shall have a provision for angular adjustment of the mounting structure to get maximum utilization of incident sunlight. It shall be mounted facing south and tilted to an angle equal to the latitude (where being used), for optimum performance.
- 16.5.3 Solar panel supporting structure shall be hot dip galvanized MS frame.
- 16.5.4 The supporting structure shall incorporate corrosion resistant hardware for all external connections.
- 16.5.5 The installation shall include the electrical wiring, cabling, terminations, cable trays, string inverters, metering and hooking up the system to the electrical Panels of the buildings.
- 16.5.6 The PV modules shall be installed with necessary tilt with the most effective orientation in accordance of the locations of the buildings.
- 16.5.7 The 3 phase output of the Power Conditioning Units, PCUs shall be suitably terminated to an ACDB where individual electronic communicable metering and summation metering of accuracy class 0.5s shall be carried out. The Output of the ACDB shall be suitably connected to the LT grid for feeding power to the building load. The energy supplied by Solar PV system shall be monitored and available in the central display. In case of grid failure, the inverter shall be isolated from the circuit. Suitable provision, protection as per the IEEE 929, UL 1741, IEEE 1547 and IEEE 1543 shall be provided.
- 16.5.8 Supply and installation of cables on prefabricated GI cable trays and / or within suspended ceiling spaces including installation, cable trays, hangers, supports, cable terminations all fixing accessories (terrace to plant room inclusive of PVC sleeve/ other accessories etc. wherever required).
- 16.5.9 Supply and installation of GI/ copper earthing system with testing joint for every pit (grounding) system including timely coordination with building contractor and/or cutting of roads / paved areas and making as good as in original shape. Design shall be submitted by contractor and approval obtained from the Engineer.
- 16.5.10 Supply and installation and testing of entire system including automatic synchronization and isolation with plant main LT Panel grid, DG set and UPS.
- 16.5.11 Supply fixing, testing commissioning of lightening arrester for connecting to the PV panels.
- 16.5.12 The system must be capable of communicating with PCUs on a network logging all parameter like generated power in KW / KVA, voltage, current, frequency etc. inclusive of

Energy meter (Electronic / Multifunctional).

- 16.5.13 The system must be capable of upgrading, extension at later stage as and when required. Adequate capacity may be provided in PCUs to accept addition of SPV panels at later date.
- 16.5.14 Supply and laying of power and control copper cables from PV power panel to plant room Main LT panel including within terraces to main P V panels.
- 16.5.15 Contractor shall design their SPV panel structure according to RCC roof. Design of SPV structure and distribution of load on roof top beam shall be coordinated with the civil structure design, well in advance. Contractor shall provide the staircase or pathways for accessibility of Solar PV panels if not provided.
- 16.5.16 Data networking cabling as per site requirement from PV solar system to existing plant room.
- 16.5.17 Danger notice plates at some prominent locations as per IS: 2551.
- 16.5.18 Contractor shall ensure that the installation, performance, testing, commissioning, warranty, etc. are as per latest MNRE guidelines.

(End of Chapter-16)

CHAPTER 17- CIVIL WORKS

17.1 GENERAL

The Contractor shall undertake Design and Construction of following buildings and structures guaranteeing at least minimum facilities as described herein but not limited to:

- (1) **Ancillary Buildings:** Control Room Building at Traction Sub-station (TSS), Sub Sectioning, & Paralleling Posts (SSPs), S&T Service Buildings in the block section (Auto Location Huts) consisting of Signalling Equipment Rooms, Telecom Equipment Rooms, Signal & Telecom Power Supply Equipment Rooms, GSM-R equipment rooms; any additional Service buildings for S&T works in Station and Block section and Structure / building as required for Auto transformers (stand-alone post if any).
- (2) **Ancillary rooms : ASS** at Service Buildings Stations / Depot adjacent or subsidiary to the main buildings as required to facilitate the provision of services like for Auxiliary Power Supply consisting of HT/ LT equipment Room, additional DG room and structure / fencing for and HV / LV transformers as per Employer's Requirements.

The Contractor shall be responsible for land preparation, boundary wall, entrance gate, foundations, support anchor blocks, Fire / Baffle walls between transformers (as per the requirement identified in the Employer's requirement Volume-2 PS for Railway Electrification and associated works), including architectural, civil structural, drainage, plumbing, and E&M services for the above buildings. All such parts and accessories shall be deemed to be within the scope of this specification whether specifically mentioned or not.

17.2 GEOTECHNICAL INVESTIGATION

The Contractor shall perform a detailed soil investigation to arrive at sufficiently accurate, specific information about the soil profile and the necessary soil parameters of the site so that the foundation of the various structures can be designed and constructed safely and rationally.

- 17.2.1 A report to the effect will be submitted by the Contractor for the Engineer's specific approval giving details regarding data proposed to be utilized for civil structures design.
- 17.2.2 The contractor may visit the site to ascertain the soil parameter before submitting the bid. Any variation in soil data shall not be constitute a valid reason for any additional cost & shall not affect the terms & condition of the contract. Tests may be conducted under all the critical locations i.e. Control Room Buildings, locations of structure and Transformers etc.
- 17.2.3 The Contractor shall submit the detailed report containing information regarding the geological detail of the site, summarized observations and test data, bore logs, and conclusions and recommendations on the type of foundations with supporting calculations for the recommendations shall be provided.

17.3 ELECTRICAL RESISTIVITY OF SOIL

This test shall be conducted to determine the electrical resistivity of the soil required for designing safe grounding system for the entire station area. The specifications for the

equipment and other accessories required for performing electrical resistivity test, the test procedure, and reporting of field observations shall confirm to IS:3043. The test shall be conducted using Wagner's four electrode method as specified in IS: 1892, Appendix-B2. Unless otherwise specified at each test location, the test shall be conducted along two perpendicular lines parallel to the coordinate axis. On each line a minimum of 8 to 10 readings shall be taken by changing the spacing of the electrodes from an initial small value of 0.5m upto a distance of 10.0m.

17.4 LAND PREPARATION

- 17.4.1 The Bidder is advised to inspect the sites for various Substation and Switching station locations and gather for himself various details such as topography and land levels, soil condition including the safe bearing capacity, soil resistivity etc. HFL (highest flood level) at the Substation site, drainage requirements etc. in order to ensure that the work content is fully appreciated by him at the time of preparation of bid.
- 17.4.2 The site shall have to be cleared of all existing encumbrances, leveled and compacted. The compaction of soil shall be done in accordance with Standard Engineering practices and shall be fit to support the transportation of heavy equipment, including transformers whose weight may be in the region of 100-150 tones (or higher as per contractor's design). During land preparation, if it becomes necessary to cut or transplant trees, it shall be done by the Contractor with the approval of DFCC.
- 17.4.3 The density of filled materials shall be compacted as per relevant IS : 2720 (latest version) and as per direction of the Engineer. Backfilled earth shall be compacted at Optimum Moisture Content ("OMC"). The sub-grade for the roads and embankment filling shall also be compacted at OMC.
- 17.4.4 Land for temporary work required if any beyond Right of Way (ROW) shall be arranged by the contractor at his own cost.

17.5 ROAD & CULVERTS

- 17.5.1 The Contractor shall make his own arrangements, subject to the consent of the Engineer, for access required to the Site. The Contractor will negotiate with the land owners or other appropriate government agencies to seek temporary occupation of land and seeking necessary permission for construction of temporary access roads. The existing access roads may be used by the Contractor for transport of his men, material and equipment. However, these shall be maintained by the Contractor to a satisfactory level to allow uninterrupted flow of traffic including the public traffic otherwise using these roads. The preparation & strengthening including modification of existing roads to meet the site conditions for access to Power supply installation i.e. TSS, SSP and ATS if any are in the scope of the Contractor.
- 17.5.2 The Contractor will be required to provide suitable pathways to afford easy reach to equipment in the switchyard. A motorable road should be provided to permit vehicle movement upto Control Room for TSSs.
- 17.5.3 It may be noted that the roads within the substation and SSP as required shall be constructed by Contractor CP-105 to permit transportation of all heavy equipment. The roads shall have min. 5.0m wide RCC road. Road construction shall be as per IRC standards.
- 17.5.4 Adequate provision shall be made for road drainage. Protection of cut and embankment slopes of roads as per slope stability requirement shall be made. All the culverts and

allied structures (required for road/rail, drain trench crossings etc.) shall be designed for class A loading as per IRC standard / IS code and should be checked for loading.

17.6 DRAINAGE

17.6.1 At all times unfinished construction shall have adequate drainage. Upon completion of the road's surface course, adjacent shoulders shall be given a final shaping, true alignment and grade.

17.6.2 Drainage of the Substation site shall be provided as per the best engineering practices, so as to prevent surface flooding and pooling of water. For this purpose, suitably designed drains and sumps shall be provided and if the water level inside the sump rises above a predetermined level, the sump water shall be arranged to be evacuated by means of suitable automatic electric pumps fixed in the sump.

17.6.3 Suitable precautions as per IE Rules shall also be taken to prevent transformer insulating oil from being discharged into the environment in the event of a ruptured transformer tank.

17.6.4 This shall be realized by a retention tank for each transformer:

- (1) Dimensioned in order to be able to contain the whole transformer oil
- (2) Laid below the transformer
- (3) Covered by a net to maintain a 5 cm width stone bed on which the oil might fall
- (4) Fitted with a side extraction pit to be used for oil or raining water pumping

The pumping shall be realized with a portable manual or electrical pump, which is to be stored in the maintenance room.

17.7 FOUNDATION WORK

17.7.1 In the Traction Substations (TSSs) and SSP, the Contractor shall provide a road & rail system integrated with the transformer foundation to enable installation and the replacement of any failed unit by the spare unit located at the site. The Contractor shall connect such rail system to the adjoining Railway track for easy transport of the Transformers and heavy equipment through rail transport as per the requirements of ACTM. This system shall enable the removal of any failed unit from its foundation to the nearest road.

17.7.2 The procedure used for the design of the foundations shall be the most critical loading combination of the structure and or equipment and/or superstructure and other conditions, which produces the maximum stresses in the foundation or the foundation component and as per the relevant IS Codes of foundation design. Detailed design calculations shall be submitted by the Contractor showing complete details of piles/pile groups or isolated /combined footings proposed to be used. The Contractor shall submit calculations for foundations structure for transformer and other equipment for approval. The foundations shall be cast after the acceptance of the design.

17.7.3 Concrete shall conform to the requirements mentioned in IS: 456 and all the tests shall be conducted as per the relevant Indian Standard Codes as mentioned in Standard Field Quality Plan appended with the Specification. A minimum grade for PCC and RCC shall be used for all structural/load-bearing members as per latest IS 456.

- 17.7.4 If the site is wet, the foundation height will be adjusted to maintain the exact level of the top of structures to compensate slopes. The switchyard foundation's plinths and building plinths shall be minimum 300mm and 500mm above Finished Ground Level (FGL) respectively.
- 17.7.5 The design and detailing of foundations shall be carried out based on the approved soil data and sub-soil conditions as well as for all possible critical loads and the combinations thereof. The spread footings foundation or pile foundation as may be required based on soil/sub-soil conditions and superimposed loads shall be provided.
- 17.7.6 All sub-structures shall be checked for sliding and overturning stability during both construction and operating conditions for various combinations of loads. Factors of safety for these cases shall be taken as mentioned in relevant IS Codes or as stipulated elsewhere in the Specifications. For checking against overturning, weight of soil vertically above footing shall be taken and inverted fulcrum of pyramid of earth on the foundation should not be considered.
- 17.7.7 Only approved admixtures shall be used in the concrete for the Works. When more than one admixture is to be used, each admixture shall be batched in its own batch and added to the mixing water separately before discharging into the mixer. Admixtures shall be delivered in suitably labeled containers to enable identification.
- 17.7.8 Admixtures in concrete shall conform to IS: 9103. The water proofing cement additives shall conform to IS: 2645. The Engineer shall approve concrete Admixtures/ Additives for use.

17.8 CABLE & PIPE TRENCHES

- 17.8.1 The cable trenches and precast removable RCC cover (with lifting arrangement) shall be constructed using RCC of M25 grade for substation. Cable trench covers shall be designed for self-weight of top slab + concentrated load of 200 kg at centre of span on each panel. Cable trenches crossing the road/rails shall be designed for class A loading of IRC/relevant IS Code and should be checked for transformer loading.
- 17.8.2 Trenches shall be drained and necessary sumps be constructed and sump pumps if necessary shall be supplied. Cable trenches shall not be used as storm water drains. The top of trenches shall be kept at least 100 mm above the finished ground level at the new substations. The top of cable trench shall be such that the surface rainwater does not enter the trench.
- 17.8.3 All metal parts inside the trench shall be connected to the earthing system. Cables from trench to equipment shall be run in hard conduit pipes. Trench walls shall not foul the foundations and suitable gaps shall be provided. The trench beds shall have a slope of 1/500 along the run & 1/250 perpendicular to the run.
- 17.8.4 Cable trenches shall be blocked at the ends with brick masonry in cement sand mortar 1:6 and plaster with 12mm thick 1:6 cement sand mortar.
- 17.8.5 Cable trenches shall contain cable trays which shall be supported on ISA. The size and spacing of angle sections shall be as per design criteria mentioned above.
- 17.8.6 Cable trenches shall be provided for 25kV, 400 V, 230V and 110 V cables.
- 17.8.7 A separate control wire duct shall be provided for cable connections from the yard equipment to the control room building equipment and within the control room building.

17.9 GRAVEL SPREADING

The Contractor shall furnish all labour, equipment and materials required for complete performance of the work in accordance with the Specification Vo. 2 PS and as per direction of the Engineer. Gravel spreading shall be carried out in the areas of the switchyard wherever equipment and or structures are to be provided under present Scope of Work covering entire fencing area.

17.10 FINISHING

17.10.1 After all the structures/equipment are erected, the surface of the switchyard area shall be maintained, rolled/compacted to the lines and grades as decided by the Engineer. De-weeding including removal of roots shall be done before rolling is commenced. The final formation level shall however be very close to the formation level indicated in the drawing using a half-ton roller with suitable water sprinkling arrangement to form a smooth and compact surface.

17.10.2 A base layer of uncrushed/crushed/broken stone of 20 mm nominal size (single sized) shall be spread and rolled/compacted by using a half ton roller with 4 to 5 passes and water sprinkling to form a minimum 50 mm layer on the finished ground level of the specified switchyard area excluding roads, drains, cable trench and tower and equipment foundations as indicated in the drawings.

17.10.3 Over the base layer of site surfacing material, a final surface course of minimum 50 mm thickness of 20 mm nominal size (single sized) broken stone as specified above shall be spread and compacted by a light roller using half ton steel roller (width 30" and 24" dia meter) with water sprinkling. The water shall be sprinkled in such a way that ponding does not take place.

17.10.4 The Contractor shall arrange at their cost all labor, equipment and materials required for complete performance of the work in accordance with the drawings, specification and direction of the Engineer.

17.11 GATES AND FENCING

17.11.1 The gate frame shall be made of medium duty MS pipe conforming to relevant IS with welded joints. The gates shall be fabricated with welded joints to achieve rigid connection. The gate frames shall be painted with one coat of approved steel primer and two coats of synthetic enamel paint.

17.11.2 Gates shall be fitted with approved quality iron hinges, latch and latch catch. The latch and latch catch shall be suitable for attachment and operation of a pad lock from either side of gates. Hinges shall permit gates to swing through 180 degree back against fence. The gates shall be earthed by G I wire. The gates shall be fitted with galvanized chain hooks or gate hold back to hold gates open. Double gates shall be fitted with center rest and drop bolt to secure gates in closed position with suitable provision of barbed wires and anti-climbing device as approved by the Engineer.

17.11.3 The arrangement shall be generally as per the drawing DRG No. DFCC/Chain link fencing/TYP-001.

17.12 SWITCH YARD LIGHTING

17.12.1 The Scope of Work consists of the design, engineering, supply, installation, testing and

commissioning of lighting fixtures complete with lamps, supports and accessories.

- 17.12.2 The switchyard lighting shall consist of normal lighting and emergency lighting. This includes street lighting and flood/spot lighting from towers. The illumination levels(LUX) shall be maintained as per the Attachment at 20.2.
- 17.12.3 The lighting at substations switching Yards shall be through Lighting cum Lightning Mast system maintaining adequate uniform illumination level of minimum of average 50 lux (at 1 m above ground level) as well as Electrical Clearance from the conductors, Bus system, Equipment and live parts. The clearance shall not be less than 3.5 meters from the live conductors as per IE rules.
- 17.12.4 The complete lighting fixture shall have an Ingress Protection code of IP 65 to ensure good protection against dust and water (raining).

17.13 ANCILLARY BUILDING:

The provision of this clause is applicable to Traction substation (TSS) and Switching Stations (SSPs) control rooms, Auxiliary substations (ASS), Signal Equipment Rooms, Telecom Equipment Room and S&T Power Supply Equipment Rooms for Signalling and Telecommunication works in Block Section at Auto Location Huts, GSM-R locations and Interfacing IR Station as required and additional buildings, if any for Signalling and telecommunication works over and above the SER, TER and S&T Power Supply Equipment Rooms in Station and Block Section. The Contractor shall study the General Layout of these Building, shown in the Layout drawing. The structure shall be of RCC framed structure in compliance with IS codes. Based on this, the Contractor will be required to prepare and submit detailed design of civil, structural, architectural and electrical works. All applicable building regulations shall be observed, and also the rules for good building practice. After obtaining the Engineer's approval, the Contractor will construct the building along with auxiliary works, in accordance with approved drawings and designs.

17.14 CIVIL & STRUCTURAL DESIGN

- 17.14.1 The Contractor shall carryout the civil and structural design, including the preparation of calculations, drawings, specifications, cost estimates and other documents, for but not limited to:
- (1) General arrangement (layout and elevation)
 - (2) Structures and sub-structures
 - (3) Foundations
 - (4) Drainage (Covered type)
 - (5) Networks (Water, sewage, etc.)
 - (6) Fire/ Baffle walls
 - (7) Boundary walls/ Fencing
- 17.14.2 Building structures shall be designed for the most critical combinations of dead loads, super- imposed loads, equipment loads, crane load, wind loads, seismic loads, and temperature loads. Dead loads shall include the weight of structures complete with finishes, fixtures and partitions and should be taken as per IS: 1911.

- 17.14.3 Super-imposed loads in different areas shall include live loads, minor equipment loads, cable trays, small pipe racks/hangers and erection, operation and maintenance loads. Equipment loads shall constitute, if applicable, all loads of equipment to be supported on the building frame.
- 17.14.4 The wind loads shall be computed as per IS 875, The Seismic Coefficient method shall be used for the seismic analysis as per IS 1893 with importance factor 1.5. Wind and Seismic forces shall not be considered to act simultaneously.
- 17.14.5 Floors/slabs shall be designed to carry loads imposed by equipment, cables piping, equipment and other loads associated with the buildings. Floors shall be designed for live loads as per relevant IS. Cable and piping loads shall also be considered additionally for floors where these loads are expected.
- 17.14.6 For consideration of loads on structures, IS: 875 shall be strictly adhere to. Any other load within the structure, not mentioned in IS 875 shall be calculated as per relevant IS code and NBC.

17.15 ARCHITECTURAL SERVICES

The architectural design shall include but not be limited to site plans, floor plans, elevations, sections including detailed design and drawings. Structure would have signature architecture in terms of Elevations and other architecture elements including efficient use of Green Building concepts using optimum solar energy.

The Contractor shall perform the architectural services design, including the preparation of calculations, drawings, specifications and other documents, for but not limited to:

- (1) General arrangement (layout and elevation)
- (2) Section and details
- (3) Walls, floors, ceiling finishing
- (4) Doors, frames and windows
- (5) Toilet rooms, and partitions including equipment
- (6) Concrete (types and treatments)
- (7) Thermal and moisture protection
- (8) Electrical and mechanical fittings
- (9) Building surrounding environmental arrangement

The standard of architectural work should be of the same level as existing for other surrounding buildings of DFCC's Stations.

17.16 E&M / BUILDING SERVICES

The Contractor shall perform the building services design, including the preparation of calculations, drawings, specifications and other documents, for the work as below but not limited to:

- (1) Lighting, fans and sockets;
- (2) Ventilation;

- (3) Air-conditioning as required;
- (4) Fire detection;
- (5) Cables routing (cable trenches, trough, trays etc.);
- (6) Earthing;
- (7) Water pumps;
- (8) Access control system.

17.17 GENERAL REQUIREMENTS FOR S&T BUILDINGS

17.17.1 The General Requirement for SERs, TERs, S&T Power Supply Equipment Rooms, Auto Location Huts, GSM-R Rooms, is specified in Table -17.1 below:

Table 17.1

S. No.	Description	Specifications	Skirting / Dado
1.	Signalling & Telecom Equipment Rooms, ALHs & GSM-R Equipment Rooms	Ceramic tile flooring	Same with 100 mm high,
2.	Signalling & Telecom Power Supply Equipment Rooms	Acid Proof tiles for flooring.	Same with 2 meter high,
3.	Doors	Door Frame – Steel section painted with Enamel paint.	
		Shutter Door – Water proof flush Door Steel section painted with Enamel paint.	
4.	Ventilators	Ventilator as per Drawing.	
		Grill – Steel painted with Enamel paint	
5.	Internal Finish	Cement Plaster on all walls and finished with colour wash.	
6.	External Finish	Cement Plaster on all walls and finished with snowcem paint or equivalent.	
7.	False Ceiling	600X600 mm calcium silicate panels for Signal & Telecom Equipment Room,	

17.17.2 The S & T Equipment Rooms at the station and in the block section are required to be so designed so that there is proper ventilation and the temperature inside the rooms does not raised much above the ambient temperature. These Rooms should also be dust resistant so that the performance of the equipment does not degrade during its rated life cycle. The Signalling & Telecommunication equipment particularly the electronic based equipment are sensitive to dust and temperature.

17.17.3 The GSM-R Room where required shall be constructed to the same specification and size as defined for Telecom Equipment Room.

17.17.4 Although the exact size of the SERs, TERs and S&T Power Supply Equipment Rooms will be determined at the design stage, the minimum carpet area shall be as per Drawing DFCC/S&T/01/2016 and DFCC/S&T/02/2016 included in Part – 4, as applicable.

17.18 GENERAL REQUIREMENTS FOR CONTROL ROOM BUILDINGS (ELECTRICAL)

17.18.1 While planning and constructing the buildings and rooms for electrical equipment, care must be taken to ensure that:

- (1) All operational requirements are satisfied
- (2) The rooms are free from groundwater and flooding
- (3) Adequate accesses are provided for operation, transport and fire-fighting services
- (4) All applicable building regulations are respected
- (5) The building is structurally and functionally adequate in all respects and aesthetically presents a good appearance

Materials used for the construction of the building shall be new and of good quality. Materials shall be so chosen that the buildings when erected shall have good heat and sound insulation properties in normal conditions, as well as when combined with the heating or air-conditioning equipment installed by the Contractor.

The height of the control room shall be at least 4.2 mtr.

17.19 WALLS, CEILING & FLOORS

Walls, ceiling and floors must be dry. Both external and internal walls shall be sound proof and 2 hours fire proof. The inside surfaces of the walls should be as smooth as possible to prevent dust deposits. The ceiling shall be finished in such a way that the equipment are not endangered by falling plaster. The floor surface must be easy to clean, pressure-resistant, non-slip and wear-resistant. Concrete floor shall have adequate strength to withstand movement of equipment/panels. Attention must be paid to floor loadings when taking the equipment in and out. In front of control panels, insulated mats of approved design shall be provided. The internal walls & ceiling shall be finished with plastic emulsion in the control room and oil bound distemper in other rooms. Exterior wall finishes shall withstand the natural weathering effects with minimum periodic maintenance.

17.20 DOORS AND WINDOWS

- (1) Windows to each room shall be of an area, about 20% of the room floor area. Windows must be so arranged that they can be opened and closed without any personnel coming dangerously close to any live parts. All windows of the ground floor building shall be fitted with burglar bars firmly attached to the structure of the building. All opening windows shall be fitted with locks. Internal doors shall be 2 hours fire rated and shall be fitted with door closers, lever latches, mortise lock and keys.
- (2) External doors shall be of solid external quality and hung with heavy-duty hinges.
- (3) Provision of window(s) is not required in Telecom Equipment Rooms and S&T Power Supply Equipment Rooms.

17.21 VENTILATION

- (1) The rooms must be sufficiently ventilated. In the control room, where staffs are likely to be present constantly, pleasant climatic parameters shall be maintained.

- (2) The rooms where switchgears are installed, the maximum relative humidity should not exceed 70%. The maximum ambient temperature inside the room, averaged over 24 hours shall not exceed 35°C.

17.22 BATTERY ROOMS

In battery rooms, the following additional precautions have to be taken:

- (1) The walls & floor shall be resistant to electrolyte action and provided with acid resistant tiles.
- (2) Ceilings shall be painted with acid-resistant paint which does not give off harmful vapours.
- (3) Ventilation by means of induced draught shall be adopted. An air change rate of 6 times per hour the room volume shall be considered in the design as per NFPA guidelines.

17.23 WATER SUPPLY, ELECTRICITY, SANITATION

- (1) The buildings shall be supplied with continuous (24 hour) water to the wash rooms.
- (2) The toilets which shall use raw water for flushing shall be equipped with water closets, sitting type stools and urinals and shall be adequately ventilated through the ceiling.
- (3) The Contractor shall provide the necessary arrangements for the constant and hygienic disposal of all effluent, sewerage and rubbish from the buildings to the nearest sewer line or septic tank as applicable (Except at SPs & SSPs).
- (4) All buildings shall be supplied with electricity at 230 volts, at 50 Hz.

17.24 EXTERIOR FINISH

External finish of the Control Room Building shall be attractive and pleasing to the eye preferably of stable and durable cladding of sandstone or equivalent of approved shade and design. The building shall have a good exterior finish as approved by the Engineer.

17.25 INTERNAL EQUIPMENT

The Control Room building shall be designed and constructed to accommodate the following equipment and facilities:

- (1) Power equipment room
 - Low voltage distribution cubicles (AC and DC)
 - Battery chargers
- (2) Battery Room
 - Batteries
- (3) Control Room
 - Control and Relay panels
 - SCADA equipment, including RTU
- (4) Rest Room and Toilets
- (5) Maintenance and store room
- (6) Tools and Plants room

17.26 LIGHTING & POWER

Normal lighting and power supplies

- (1) The lighting and power auxiliary outgoings located in AC auxiliary cubicles, forming the exit point for all the normal lighting supplies and power connections, shall be supplied from both Auxiliary transformers.
- (2) Each outgoing circuit shall be protected by a miniature circuit breaker, provided with differential protection.

17.27 EMERGENCY LIGHTING

Emergency lighting system will be provided evenly by means of self-contained units in the various accesses and ways to indicate the way to exit. For this purpose, UPS of suitable capacity shall be provided.

17.28 LIGHTING EQUIPMENT

- (1) The illumination level shall be maintained in the control room, store and battery room etc. as specified in the Attachment 20.2.
- (2) The light fittings proposed by the Contractor are subject to approval by the Engineer.

17.29 POWER SOCKETS

- (1) The power Sockets shall be of sealed, wall mounted type, 5-pin rated for 16 A and 32/63 Amps for single phase and 3-phase load with a cover flap fitted with a plug holding pin.
- (2) Suitable capacity power sockets for oil filtration plant at minimum 2 (two) locations shall be provided near the transformers.
- (3) The external sockets shall be mounted on mast, at the level of each circuit breaker.

17.30 SAFETY EQUIPMENT

The Contractor shall supply one safety tool board comprising at least:

- Insulated gloves
- Insulating stools
- Protecting glasses
- Body lifting pole
- Single pole voltage detection
- Movable earthing and short circuit equipment
- Insulated cable cutting pliers
- Danger/hazard notices

- Salt to avoid kidney blocking

The battery rooms shall be fitted with eye wash equipment.

17.31 CABLE PATHS

- 17.31.1 The Contractor shall provide suitably prepared cable paths in the form of RCC trenches, Ducts and pipes as required in terms of IS:1255 or EN:61537 in the HV yard and inside the Power Supply Control Room Buildings. The cable path in the open yard shall be in the form of suitable RCC cable trenches with appropriate RCC covers or in the form of Heavy Duty PVC pipes of suitable diameter, subject to the Engineer's approval.
- 17.31.2 The cable paths below floor level, inside the rooms shall be in the form of cable trenches with necessary cable supports and covered by steel/aluminium checker plates of good and aesthetic quality.
- 17.31.3 As the cable routes involve different disciplines, they shall be physically separated. The power and control cables shall be physically separated as per IE Rules and prudent practices.
- 17.31.4 The Contractor shall submit cable route plans, cable trench cover drawings, to the Engineer, for approval, in advance of construction work.

17.32 SIGNAGE

The entire Substation (TSS) and SSP premises shall be provided with suitable Building signage. Depending upon the layout and construction finally adopted, the various installations shall be provided with sign boards. These sign boards are in addition to equipment labelling, which shall be provided as per approved drawing. The Contractor shall submit drawings for the proposed signage, for the Engineer's approval and the signage shall be provided in accordance with approved drawings.

(End of Chapter-17)

CHAPTER 18– UNINTERRUPTED POWER SUPPLY (UPS)

18.1 GENERAL

18.1.1 The section covers the Design, supply, installation, testing and commissioning of UPS as described herein in this chapter. The Contractor shall assess the capacity and provide UPS meeting Emergency Power requirements as described below:

- (1) Auxiliary SCADA system and associated equipment at Stations and Depots;
- (2) Very critical light load (at least 20% of the normal light load);
- (3) Small power sockets for computers at Stations and Depots etc.;
- (4) Access control system, Security Light, emergency signage;
- (5) Fire Alarm & Control System

18.1.2 The contractor shall obtain approval of the Engineer for final sizing of UPS. Indicative UPS Supply requirement is shown in Attachment – 20.3 to these Specifications.

18.1.3 Uninterrupted Power Supply shall be provided for CCTV, access control system and Intruder detection system at the TSS and SSPs as required.

18.2 SUBMITTAL

18.2.1 The Contractor shall submit material list and technical data including schematic diagrams to the Engineer for approval, before installation.

- (1) Installation detail drawings of UPS system and Batteries (Dimension plan, section view, required clearances and location of all associate equipment).
- (2) Installation detail drawings of Cables & Raceways and its accessories connected with the UPS and Batteries.

18.2.2 Installation and operation manuals

- (1) The Contractor shall submit calculation sheets for batteries capacity based on ambient operating temperature.
- (2) The Contractor shall submit the battery de-rating curve and the data related to decrease in life expectancy due to room temperature variation.

18.3 MATERIAL DESCRIPTION

18.3.1 The UPS system shall be True Online Double Conversion System consisting of rectifier/charger, inverter, static bypass transfer switch, manual bypass switch, dedicated battery banks (for each UPS) of SMF lead acid batteries and other equipment necessary for completion of the system.

18.3.2 The UPS shall be a dual unit parallel-redundant type suitable for continuous operation.

18.3.3 The Contractor shall ensure that the harmonics generated by each UPS unit shall not affect the performance of the electrical distribution system.

18.4 PHYSICAL REQUIREMENT

- 18.4.1 The UPS equipment shall be housed in a free-standing, floor mounted with Ingress protection as per application duty requirement, designed for heavy-duty applications and constructed of steel, or equivalent. All components and materials shall be new version of the current state-of-the-art.
- 18.4.2 All equipment in the system shall form a match and lineup configuration.
- 18.4.3 Equipment shall be designed for front access.
- 18.4.4 Enclosures shall be coated with required coats of anti-sulphuric or anti-alkaline enamel Inside and outside within the manufacturer standard color. All equipment doors shall be hinged and provided with lockable handles (all keyed alike), or pad- lockable handles.
- 18.4.5 All status, alarm and Instrumentation displays and all normal operator controls shall be visible and accessible to a person standing on the floor.
- 18.4.6 All power circuit sub-assemblies except major magnetic elements shall have the capability of Insertion or removal by one person without the use of mechanical means except to remove screws/bolts, Sub-assemblies performing similar functions shall be interchangeable. All power connections shall be bolted and readily accessible.
- 18.4.7 Control sub-assemblies shall be in racks or trays. Printed circuit boards shall be grouped according to function in a single location/rack in the module.

18.4.8 Protective Devices Requirement

The following protective devices and system shall be equipped within the UPS system:

- (1) Switches with Fuse for main AC input protection;
- (2) Circuit Breakers for DC Input protection;
- (3) Switches with Fuse for AC output protection;
- (4) Alarm warning system for the Rectifier, Charger, Inverter and Bypass Switches;
- (5) Phase sequence, Reverse Power Relay, Earth fault, Low battery voltage, Self-diagnostic annunciation system;
- (6) Separation of electronic load equipment with power distribution equipment shall be used as per IEEE standard 1100-2005, Chapter 8, Figure 8.1 (d).

18.4.9 Performance Requirement

The UPS shall be Parallel redundant for 24 hour application duty requirement.

18.4.10 Technical Specifications

- (1) Technology – IGBT based on line double conversion technology with high frequently PWM.

Input:

a)	Voltage	160V – 280 Volts single phase 350 – 475 Volts for three phase
b)	Frequency range	50 ± 8 Hz
c)	Power factor measured at input terminal shall be more than 0.8 at full load	

Output:

a)	Voltage 3 Phase	400V ± 1%
b)	Output frequency	50V ± 0.5 Hz(free running)
c)	Output Waveform	Sine
d)	Load Power factor	May vary from 0.65 to unity
e)	Transient response	230V ± 5% for 0-100% load jump and vice versa
f)	Transient recovery time	40 ms for 0-100% load jump and vice versa
g)	Phase displacement (for 3 phase out put only)	a. With balanced load 120 ± 1 b. With unbalanced load 120 ± 3.0
h)	Total Harmonic Distortion	a. <2% for 100% Linear load b. <4% for 100% Non-linear load
i)	Overall efficiency	>50% from 50% to 100% load
j)	Over Load	a. 125% for minimum 10 min. b. 150% for minimum 1 min.
k)	Crest Factor	Better than 3:1

- (2) Backup time: 30min at 100% load, 0.95 pf. Each UPS shall have dedicated battery sets.

18.5 CONTROL AND ANNUNCIATION SYSTEM

- 18.5.1 The UPS shall incorporate the necessary control, Instruments and annunciation to perform the completed function and to allow the operator to monitor the system status and performance as well as to take any appropriate action.
- 18.5.2 The control and annunciation system shall be microprocessor based control, complete with LCD display for monitoring of events and measured values.
- 18.5.3 The visible and audible alarm for the UPS shall be provided.
- 18.5.4 The minimum requirement for the measuring values for monitoring shall be as listed:
- (1) Input: Voltage, Frequency, Power
 - (2) Output: Voltage, Current, Frequency, Power
 - (3) Battery Output: Voltage, Current, Temperature, Autonomy time
- 18.5.5 The minimum requirement for the status and alarm for monitoring shall be as listed:
- (1) Rectifier: Off Over Temperature, Failure
 - (2) Inverter: Off, Over Temperature, Failure
 - (3) Battery: On Load, Over Temperature
 - (4) Load on Bypass
 - (5) Overload
 - (6) Network Interfacing
- 18.5.6 A Network/Communication ports shall be provided within the UPS for remote monitoring and management.
- 18.5.7 The interface units shall be provided to interface with the BMS / SCADA System for remote monitoring and management.
- 18.5.8 The UPS and Battery management software shall be provided complete with license number and documentation.

18.6 INSTALLATION

- 18.6.1 The UPS and Battery Bank including associated equipment shall be installed in spaces to be decided with the engineer.
- 18.6.2 The installation, size of cables and conduits shall follow the instructions from the manufacturer.

18.7 TESTING

- 18.7.1 Upon completion of installation, the UPS and associated equipment shall be tested within the minimum requirement as follow:
- 18.7.2 The system shall be tested involving electrical characteristics as specified above for the following load conditions.
- (1) No Load
 - (2) 50% Load (Dummy Load)
 - (3) Full Load (Dummy Load)
- 18.7.3 Record Input and output voltage/current wave form, which shall be measured in each load condition of 0%, 25%, 50%, 75% and 100%.
- 18.7.4 The overall efficiency of the UPS shall be >0.95.
- 18.7.5 The overall efficiency at 100% load shall be measured and recorded for each condition of main power supply from utility line and from batteries.
- 18.7.6 Grounding of the system shall be tested and results recorded.

(End of Chapter-18)

CHAPTER 19 – ACCESS CONTROL SYSTEM

19.1 GENERAL

This section of the Specification identifies the Performance requirement of Access control system including design, supply, installation, testing and commissioning complete with all accessories for efficient and trouble-free operation.

The access control system shall be installed in the Control room Buildings of Traction substations, Switching Stations (i.e. TSS and SSPs etc.), and Auxiliary Substation. The access control system shall be modular and expandable.

19.2 SCOPE OF WORK

Design, Supply, Installation, Testing and Commissioning of Access Control System and Security Alarm System for the following locations of Dadri – Khurja section of DFCCIL:

- a) Main Entry gates (TSS,& SSPs);
- b) Control Room building (TSS)
- c) Auxiliary substation

19.3 FUNCTIONAL REQUIREMENTS

- (1) The main Workstation PC shall be kept in the OCC and security / control room of depot and substation (TSS,SSP and ASS). It should be connected with Main network PC at OCC. The access to the System shall be limited by passwords. It shall be possible to generate Time& Attendance reports from the software and Daily Report (general), Daily Report (section wise).
- (2) The system shall be capable of supporting the latest technology free of risks of obsolescence such as Contactless Smart Card/ Biometric finger scan/ Barcode encrypted.
- (3) The System shall have facilities to have restricted control of flow of persons, monitoring and /or control of fire escape doors, recording of attendance etc. as specified in the technical specifications.
- (4) The System shall have Access Control on the controlled Gates both at the Entrance and Exit. There shall be provision of prohibition of Access through a gate in case the previous exit is not recorded and vice versa. This is to ensure that there is no piggyback entrance and/or exit.
- (5) The System will have provision to attend the alarms from Control Room at the Main Entry gate or elsewhere.
- (6) The system will have provision for automatic release of door in case of fire. The restrictive access of Access Control system will be overridden and all the controlled gates of affected rooms will be released permanently unless reset.
- (7) There will be provision of overriding the controlled access in case of an emergency by manual override from the security control room.
- (8) Each user shall be granted a unique a log in ID and Password.
- (9) Data Communication shall be Through RS 232/ 485 connectivity to facilitate

interface with other systems.

- (10) The Access Control System shall have the emergency override facility to release open the locks in case of fire or any other emergency situation. Manual override is also to be provided by means of a manual glass break door release. Also a discreet key switch needs to be provided for manual override purpose.
- (11) Suitable cables will be laid in separate MS conduit for Signal and Power Supply from each controller to reader. The controllers of each building will be connected through independent communication cable, which is also in the scope of work.
- (12) The whole Access Control System shall be UL/FM/CE approved. The makes and Model of the various subsystems/equipment shall be so selected that they are mutually compatible.

19.4 PERFORMANCE REQUIREMENTS

The performance requirement for the system shall be as below but not limited to:

19.4.1 Reliability

The Access system shall be designed with high reliability and single failure should not make the system non-functional.

19.4.2 Maintainability REQUIREMENTS

All parts of the various subassemblies of the Equipment System shall be readily accessible and removable for maintenance and adjustment. The Equipment Systems shall be so designed as to ensure easy access for easy lubrication of the moving parts and at the same time meet the standard of ingress protection stipulated for that sub-assembly. The layout of the Equipment shall be so planned that the various subassemblies can be easily removed from their normally installed location for the purpose of cleaning, checking and readjustment of any mechanism. It shall be possible to replace critical components quickly and easily with spares held at site.

19.4.3 Environmental Condition Requirements

The contractor shall ensure that the entire key equipment of the system provided herein should meet environmental conditions:

Highest temperature: 50⁰C

Lowest temperature: (-) 5⁰C.

Indoor Equipment should be drip proof and outdoor should be splash proof.

(End of Chapter-19)

CHAPTER-20-ATTACHMENTS

Attachment 20.1: Schedule of Electrical Fixtures – Junction Station

Junction Stations -							
Level	Description	General Purpose Switched Socket Outlets				Fans	
		6A 5Pin SP SSO	16A 5Pin SP SSO	16A SP SSO Indstl (IP≥65)	32A TPN SSO	Ceiling Fan	Exhaust Fan
Ground Floor	DG cum solar Room	2	2	-	-	-	1
	Battery Room	2	1	-	-	-	1
	IPS Room	4	2	-	-	-	-
	Signalling Eqpt Room	4	2	-	-	-	-
	Station Control / Panel Room	4	3	-	-	-	-
	Record Room	2	-	-	-	1	-
	Toilet Room	1	-	-	-	-	1
	Telecom Equipment Room	4	2	-	-	-	-
	Battery Room	2	2	-	-	-	1
	Power Supply Equipment Room	2	2	-	-	-	-
	Switch Room	2	2	-	-	-	-
	Toilet Room	1	-	-	-	-	1
	Verandah	1	-	1	-	1	-
	First Floor	Office	3	2	-	-	1
Running Staff Rest Room		6	2	-	-	3	-
Running Staff Rest Room		6	2	-	-	3	-
Telecom Maintenance Room		4	2	-	-	1	-
Signalling Maintenance room		4	2	-	-	1	-
Toilet Room		1	-	-	-	-	1
Inspector Rest Room		6	2	-	-	2	-
Toilet		1	-	-	-	-	1
Toilet		1	-	-	-	-	1
Officer Rest Room		4	2	-	-	1	-
Veranda		1	-	1	-	1	-
Ancillary Bldg.	HT Metering Room	2	1	-	-	-	1
	HT Panel Room	2	2	-	-	-	1
	LT panel Room	2	2	-	-	-	1
Tower Shed	6	6	4	2	-	1	

Note: The provision of the above Electrical Fixtures is indicative only. The contractor shall provide electrical fixtures as per the layout and requirement approved by the engineer.

Attachment 20.1: Schedule of Electrical Fixtures-IMSD

Integrated Maintenance Sub Depot (IMSD)							
	Rooms/Area	Socket Outlets				Ceiling Fan	Exhaust Fan
		6A, 5pin SP	16A 6pin SP	16A SP Industrial	16A SP SSO Industrial (IP≥65)		
IMSD Section,	Work Shop	1	2	-	-	1	1
	Store Electrical	1	2	-	-	1	-
	Store S&T	1	2	-	-	1	-
	Toilet Area 1	1	-	-	-	-	1
	SUP - OHE	2	1	-	-	1	-
	SUP - GS	2	1	-	-	1	-
	SUP - PSI	2	1	-	-	1	-
	SUP - SIG	2	1	-	-	1	-
	SUP - TELE	2	1	-	-	1	-
	SUP –BR/MC	2	1	-	-	1	-
	SUP - WKS	2	1	-	-	1	-
	SUP –P WAY	2	1	-	-	1	-
	Toilet Area2	1	-	-	-	-	1
	Verandah	1	-	1	-	1	-

Note: The provision of the above Electrical Fixtures is indicative only. The contractor shall provide electrical fixtures as per the layout and requirement approved by the engineer.

Attachment 20.2: Typical Type of Fittings & Illumination Level at Various Locations

TYPICAL ILLUMINATION LEVEL AT VARIOUS LOCATIONS

SN	Location	Recommended Normal Lux Level at floor level	Type of Fitting	Indoor/ Outdoor
1.	Circulating Area	150	LED	Outdoor
2.	Entrance Area	200	LED	Outdoor
3.	Covered Passage Way Corridor Stairs	150 150	LED	Indoor Indoor
4.	Stores	150	LED	Indoor
5.	Other Service Building	200	LED	Indoor
6.	Public Utility Services (Toilet/Bathroom)	150	LED	Indoor
7.	Equipment Room	300	LED	Indoor
8.	Control Room	350	LED	Indoor
9.	Staff Quarters	200	LED	Indoor
10.	Street Lighting	40	LED	Outdoor
11.	Rest Room	150	LED	Indoor
12.	Rooms	200	LED	Indoor
13.	Washbasin	150	LED	Indoor
14.	Substation building/battery room/Cable distribution Area	150	LED	Indoor
15.	Sign Boards	-	LED	Outdoor
16.	Level Crossing	50	LED	Outdoor
17.	Switch Yard	50	LED	Outdoor
18.	IMD (technical Rooms)	300	LED	Outdoor
19.	Signs, Maps, Displays	200	LED	Indoor/Outdoor
20.	Rest House / Club / Institute	200	LED	Indoor

Note:

- 1- All the rooms at the Station and Depot shall be illuminated from UPS supply maximum of 20% of Normal Illumination level as specified above subject to minimum of one light in each room as applicable.
- 2- All the rooms at the Station and Depot shall be illuminated from DG backed supply maximum of 30% of Normal Illumination level as specified above in addition to UPS circuit as applicable.

Attachment 20.3: Power Supply Arrangement

(A) Power Supply Arrangement for S&T Installation

Location	UP & DN Aux AT Supply kVA as assessed	Local Utility	DG Set	UPS	Auxiliary Transformer with ASTS (s)*
Junction Station	√	√	√	√	√
S&T Equip. rooms in block section	√	NA	NA	NA	√

*ASTS = Auto Source Transfer Switch

(B) Power Supply Arrangement other than S&T Installations

Location	Rating Solar Panel	Local Supply	DG Set	UPS	Auxiliary Transformer with ASTS (s)
Junction Station	5 kW	√	√	√	√
IMSD	1 kW	√	√	√	√
Quarters	NA	√	NA	NA	NA
TSS/SSP	NA	NA	NA	√	NA

Attachment 20.4: Matrix of Required Facilities at Various Locations

FACILITIES AT VARIOUS LOCATIONS BY CP 105 CONTRACTOR

S N	Parameters	Station Building	Control Room Building(TSS/SSP)	Auxiliary Substation	IMSD	Staff Quarters	S&T Equip. rooms in block section
1.	Conduits Concealed by CP 302 Contractor	✓	NA	NA	✓	✓	NA
	Conduits Concealed by CP 105 Contractor	NA	✓	✓	NA	NA	✓
2.	Wiring/ Cabling	✓	✓	✓	✓	✓	✓
3.	Solar Panel	✓	NA	NA	✓	NA	NA
4.	DG Set Supply	✓	NA	✓	✓	NA	NA
5.	Fire Detection and Alarm System	✓	✓	✓	✓	NA	✓
6.	Air-conditioning	✓	TSS – Telecom equipment room	NA	✓	NA	✓
7.	Ventilation / Exhaust Fans	✓	✓	✓	✓	✓	✓
8.	Traction Supply (Aux AT Supply)	✓	✓	NA	NA	NA	✓
9.	Portable Fire Extinguisher	✓	✓	✓	✓	NA	✓
10.	Access Control System	NA	✓ (Control Room building and Main entry gate)	✓	NA	NA	NA
11.	Cold water dispenser with RO arrangement	✓	NA	NA	✓	NA	NA

Note: The provision of the above facilities shall be read in conjunction with the details mentioned in the respective chapter of this PS.

Attachment 20.5: Standard List of Electrical Fittings in Quarters

Scale of Fittings for Staff Quarters Standard List of Electrical Fittings in Quarters

	Type B	Type A
Light Fitting: LED Lamps	2	2
Light Fitting: LED Tube Light	6	6
Fan	3	2
6Amp. Socket (5 pin)	3	2
16Amp. Socket (6 pin)	2	0
25 Amp. MCB (AC)	1	0
Bell	1	1
Exhaust Fan	1	1
ELCB	1	1
TV Socket	2	2
Telephone Socket	1	1
TOTAL	23	18

NOTE:

- 1- Every Room / Veranda / confined space shall be provided with One (1) Light Lamp/tube and One (1) 6A Socket.
- 2- All rooms and Verandah shall be provided with fan and Fan Box.
- 3- The above quantity is minimum and indicative only. The contractor shall be responsible to develop its design for approval of the engineer.

Attachment 20.6: Applicable Codes and Design Standards

ISO 8528-Part-1	Reciprocating Internal Combustion Engine driven Alternating Current Generating Sets- application, Ratings & Performance
ISO 8528-Part-2	Engines
ISO 8528-Part-3	Alternating Current Generators for Generating Sets
ISO 8528-Part-4	Control gear & Switchgear
ISO 8528-Part-5	Generating Sets
ISO 8528-Part-6	Test Methods
BS 5839-8	Fire Detection and Fire Alarm Systems for Buildings – Part 8: Code of Practice for the Design, Installation, Commissioning and maintenance of Voice Alarm
BS: 3116-Part-1	Automatic Fire Alarm Systems in Buildings
BS: 3116-Part-4	Control and Indicating Equipment
BS: 5445: 1984	Specification for Smoke Detectors
BS: 5446: 1984	Specification for Heat Sensitive Detectors
BS: 6387	Fire Survival Cables
BS: 7671-2001	Requirements for Electrical Installations. IEE Wiring Regulations – 16th Edition
BS7430	Code of Practice for Earthing
BS 7375	Code of Practice for Distribution of Electricity on Construction Sites
BS EN 50122	Protective Provisions Relating to Electric Safety and Earthing
BS EN 50122-2	Protective Provisions Against the Effects of Stray Currents on DC Systems
USA: UL1776	Standards for Uninterruptible Power Supply Equipment.
IEC: 60831	Shunt Power Capacitors of the Self-healing Type for AC Systems Having a Rated Voltage up to and Including 1000V
IEC 60068-2-38	Specification for Permitted Humidity Test
IEC 60146	Semiconductor Converters - General requirement and line commutated converters - Part 1-1: Specification of basic requirements
IEC60364-7-712 (2002)	Electrical Installations of Buildings Part 7: requirements for special installations or locations Section, 712: Photovoltaic power supply systems.
IEC 60529	Classification of degree of protections provided b enclosures
IEC 60598-1	General Requirements and Tests
IEC 60598-2-1	Fixed General Purpose Luminaires
IEC 6076 Part-1	General
IEC 6076 Part-2	Temperature Rise
IEC 6076 Part-3	Insulation level and die-electric tests
IEC 6076 Part-5	Ability to the withstand short circuit
IEC 6076 Part-8	Applicable guide
IEC 60950	Information technology equipment - Safety-- Part I: General Requirements
IEC 61000-3-2	Limits for Harmonic current emission – THD < 10%
IEC 61723 Ed 1.0	Safety Guidelines for grid connected photovoltaic systems mounted on the building
IEC 62040-2	Specification for UPS EMC requirement

IEC 62040-3	Uninterruptible power systems (UPS) - Part 3: Performance requirements
IEC 62446 (2009)	Grid connected photovoltaic systems - Minimum requirements for system documentation, commissioning tests and inspection
IEC: 61701	Salt mist corrosion testing of photovoltaic (PV) modules
IEC: 61730 Pt 1 & 2	Photovoltaic (PV) module safety qualification -Part 1: Requirements for construction Part 2: Requirements for testing
IEC:60068	Environmental testing
IEC:60904-1(2006)	Photovoltaic Devices- Part-I: Measurement of Photovoltaic current-Voltage Characteristic
IEC-62040-I Ed. 1.0 b	Specification for UPS. General and Safety requirements
IEC 61950	Relay software systems
IEC 62271-200	A.C. metal enclosed switchgear and control gear for rated voltages above 1 KV and up to and including 52 KV
IEC 62271-1	Common clauses for high voltage switchgear and control gear standards
IEC 62271-100	High voltage alternating current circuit breakers
IEC 62271-102	High voltage alternating current disconnectors and earthing switches
IEC 60044-1	Current transformers
IEC 60044-2	Voltage transformers
IEEE 1 100	Recommended Practice for Powering and Grounding of Sensitive Electronic Equipment
IEEE 80	Guide for Safety in AC Substation Grounding
IEEE 81	Guide for measuring earth resistivity, ground impedance and earth surface potential of a ground system
IEEE 485	Lead Acid Batteries for Stationary Applications. This standard details methods for defining the dc loads and for sizing a lead-acid battery.
IEEE 837	Standards for qualifying permanent connections used in substation grounding
NFPA 780	Standard for the installation of lightning protection system
UL 467	Ground Rods
IS 3043-1987	Indian standard code of practice for earthing
IS: 1248	Direct Acting Electrical Indicating Instruments
IS: 132947 (Part I)	Degree of Protection
IS: 13340	Power Capacitor of Self-healing Type for AC Systems Having Rated Voltage upto 650 Volts
IS: 13341	Requirements for Ageing Test, Self-healing Test and Destruction Test on Shunt Capacitors
IS: 13925	Shunt Capacitor for Power System
IS: 2705	Current Transformers
IS: 3202	Code of Practice for Climate Proofing of Electrical Equipment
IS: 3231	Electrical Relays for Power System Protection
IS: 5216 : Part I : 1982	Recommendations on Safety Procedures and Practices in Electrical Work - Part I : General
IS: 5578375 & 11353	Marking & Arrangement of Switchgear, Bus-bars, Main Connection and Aux. Wiring

IS: 7752	Guide for Improvement of Power Factor at Consumer's Installations
IS 1944	Code of practice for lighting of public thoroughfares
IS 2175:1988	Heat Sensitive Detectors for Use in Automatic Fire Alarm Systems
IS 2189: 1999	Code of Practice for Installation of Automatic Fire Alarm System
IS 60309 (Part 1): 2002	Plugs, socket outlets & couplers for industrial purpose: general requirements
IS 60309 (Part 2): 2002	Plugs, socket outlets & couplers for industrial purpose: Dimensional interchangeability requirements for pin & contact tube accessories
IS 732: 1989	Code of Practice of Electrical Wiring Installations (System Voltage not exceeding 660 V)
IS 9537 : Part 1 : 1980/IEC 60614-1 (1978)	Conduits for electrical installations: Part 1 General requirements
IS: 0118	Code of Practice for Selection, Installation and Maintenance for Switchgear and Control Gear
IS: 10028	Code of Practice for Selection, Installation and Maintenance of Transformers
IS: 10118 (Parts 1-4) - 1982	Code of Practice for Selection, Installation and Maintenance of Switchgear
IS: 10322 (All Parts)	Specification for Luminaires
IS: 10322: Part-5: Sec. 3: 1987	Luminaires: Part 5 Particular Requirements, Section 3. Luminaires for Road and Street Lighting (Superseding IS: 2149).
IS: 10418	Wooden Drums for Electric Cables
IS: 10561: 1983 / IEC 606 (1978)	Application Guide for Power Transformers
IS: 10810	Methods of Tests for Cables (All Tests)
IS: 12021	Specification for Control Transformer
IS: 1239: Part-1: 2004	Steel Tubes, Tubulars and Other Wrought Steel Fittings – Specification – Part 1: Steel Tubes
IS: 1239: Part-2: 1992	Mild Steel Tubes, Tubulars and other Wrought Steel Fittings, Part 2: Mild Steel Tubular and Other Wrought Steel Pipe Fittings
IS: 1255-1983	Code of Practice for Installation and Maintenance of Power Cables up to and Including 33kV Rating
IS: 12640	Earth Leakage Circuit Breakers
IS: 1271	Classification of Insulating Materials
IS: 12729	High Voltage Switchgear
IS: 12834:1989 (reaffirmed 2000)	Solar Photovoltaic Energy Systems - Terminology
IS: 1293/IEC 60884- 1 (2002)	Plugs and socket outlets of rated voltage up to and including 250 volts and rated current upto and including 16 amperes
IS: 1293-1988	3-pin Plugs and Socket Outlets up to 250 Volts
IS: 1302 / IEC 60928 (1990)	AC Supplied Electronic Ballasts for Tubular Fluorescent Lamps
IS: 13118	AC Circuit Breakers
IS: 13234	Short Circuit Calculation in Three Phase AC Systems
IS: 13364	Specification for AC Generators Driven by Reciprocating Internal Combustion Engine

IS: 13707	Specification for HRC fuses
IS: 13779	Digital Measuring Instrument and Testing Accessories
IS: 13947	Control Switches
IS: 13947 (Part 4)	AC contactors up to 1000V
IS: 13947 (Part I)	Degree of Protection for Enclosure
IS: 1460	Automotive Diesel Fuels
IS: 1554 (Part-I)- 1988 / IEC 60502 (1983)	PVC Insulated (Heavy Duty) Electric Cables: Part 1 for Working Voltages up to and Including 1100V.
IS: 15549	Stationary Valve Regulated Lead Acid Batteries
IS: 1646: 1997	Code of Practice for Fire Safety of Building
IS: 1777-1978	Industrial Luminaire with Metal Reflectors
IS: 1822	Motor duty Switches
IS: 1913	General and safety Requirements for Fluorescent Lamp Luminaires Tubular
IS: 1913-1978	General and Safety Requirements for Luminaires: Part 1 Tubular Fluorescent Lamps
IS: 2026	Power Transformers
IS: 2026: 1977 Part 1 to 10 / IEC 76	Specification for Power Transformer
IS: 2099: 1986	Bushing for Alternating Voltages Above 1000V (2nd Revision)
IS: 2208	Specification for HRC Cartridge Fuse Links up to 650V
IS: 2309 - 2005 Amendment -1	Code of practice for the protection of buildings and allied structures against lightning (Second Revision)
IS: 2412-1975	Link clips for electrical wiring
IS: 2551- 1982	Danger Notice Plates
IS: 2667-1988	Fittings for rigid steel conduits for electrical wiring
IS: 2705	Current Transformers
IS: 2713: Parts 1 to 3: 1980	Specification for Tubular Steel Poles for Overhead Power Lines
IS: 3043-1987	Code of Practice for Earthing
IS: 3156	Voltage Transformers
IS: 3156 & 4146	Potential Transformers
IS: 3202	Code of practice for climate proofing
IS: 3231	Electrical Relays for Power System Protection
IS: 3347-1967 / DIN 42531, 23, 3	Specification for Porcelain Transformer Bushing
IS: 335: 1993 / BS: 148, D-1473, D- 1533-1934, IEC Pub 296-1969	New Insulating Oils
IS: 3401	Specification for Silica Gel
IS: 3427	Metal Enclosed Switchgear & Control Gear for Voltages Above 1000V up to and Including 52000V
IS: 3480: 1966	Flexible steel conduits for electrical wiring
IS: 3528-1966	Water Proof Electric Light Fitting

IS: 3553	Specification for Watertight Electric Lighting Fitting
IS: 3636	Code of Practice for Interior Illumination
IS: 3646 (All 3 Parts)	Code of Practice for Interior Illumination
IS: 3696 (Part-2)- 1966	Safety Code for Scaffolds and Ladders: Ladders
IS: 3837	Accessories for Rigid Steel Conduits for Electrical Wiring
IS: 3842	Specification for Electrical Relays for AC System
IS: 3854-1997/IEC 60669-1 (1998)	Switches for domestic and similar purposes.
IS: 3961	Recommended current ratings for cables
IS: 3975	Mild Steel Wires, Strips and Tapes for Armouring of Cables
IS: 4064	Air Break Switches for Voltage not exceeding 1000V
IS: 4160-1967/IEC 60884-2-6 (1997)	Interlocking switch socket outlet.
IS: 4615-1968	Switch socket outlets (non-interlocking type)
IS: 4648-1968	Guide for Electrical Layout in Residential Buildings
IS: 4722-2001 & IEC 60034-03	Rotating Electrical Machines (2nd Revision) -2006
IS: 4889/BS: 269	Rules for Method of Declaring Efficiency and Electrical Machines
IS: 5082	Wrought Al. and Aluminium Alloys, Bars, Rods, Tube and Sections for Electrical Purposes
IS: 14772	Boxes for the Enclosure of Electrical Accessories
IS: 14772 Part-I&II 1969	Boxes for the Enclosure of Electrical Accessories
IS 10000 Part IV, 1980	Method of test for IC Engine
IS: 5216 : Part II : 1982	Recommendation on Safety Procedures and Practices in Electrical Work - Part II : Life Saving Techniques
IS: 5424- 1969	Rubber Mats for Electrical Purposes
IS: 5578-1984	Guide for marking of insulated conductor
IS: 5831	PVC Insulation and Sheath of Electrical Cables
IS: 5891-1970	Recommended Short Circuit Rating of High Voltage XLPE Insulated PVC Cables
IS: 61000 – 2-4	Electromagnetic Capability
IS: 6600: 1972 / IEC 76	Guide for Loading of Oil Immersed Transformers
IS: 6655-1972	Code of Practice for Industrial Lighting
IS: 6792: 1992 / IEC 60156 (1963)	Method for Determination of Electric Strength of Insulating Oils
IS: 694–1990 (Reaffirmed 2005)/ IEC 60227-1to 5(1979)	PVC Insulated cables for working voltages up to and including 1100 Volts – specification
IS: 7098 (Part I)	XLPE Cables - LT
IS: 7098 (Part II) or IEC:60502-2	Cross-linked Polyethylene Insulated PVC Sheathed Cables for Working Voltage from 3.3kV up to and Including 33kV.

IS: 732: 1989	Code of Practice for Electrical Wiring Installation
IS: 7671-2001	Requirements for Wiring Installations. IEE Wiring Regulations – 16th Edition.
IS: 8130 or IEC:60228	Conductors for Insulated Electric Cables and Flexible Cords
IS: 8478	Application guide for Tap- Changers
IS: 8623	Factory Built Assembly of Switchgear & Control Gear
IS: 8623 (Part-I)	Factory Built Assemblies of Switchgear and Control Gear for Voltage up to and Including 1000V AC and 1200V DC
IS: 8623 (Part-II)	Bus Bar Trunking
IS: 8828	Miniature Circuit Breakers
IS: 9000	Basic environmental testing procedure for Electronic and electrical items.
IS: 9224	HRC Cartridge Fuse
IS: 9537	Rigid Steel Conduits for Electrical Wiring (Second Revision)
IS: 9537 : Part 3 : 1983	Conduits for electrical installations: Part 3 Rigid plain conduits of insulating materials(superseding IS:2509)
IS: 9537 : Part 4 : 1983	Specification for Conduits for Electrical Installations -Part 4 : Pliable Self-recovering Conduits of Insulating Materials
IS: 9537 : Part 5 : 2000	Conduits for Electrical Installations - Part 5 : Pliable Conduits of Insulating Material
IS: 9537 : Part 6 :2000	Conduits for Electrical Installations - Specification - Part 6 : Pliable Conduits of Metal or Composite Materials
IS: 9537 : Part 8 :2003	Conduits for Electrical Installations - Specification - Part 8 : Rigid Non-Threadable Conduits of Aluminium Alloy
IS: 9537 Part 1 : 1980	Conduits for Electrical Wiring Part I – General Requirements
IS: 9537 Part 2 : 19812	Conduits for electrical wiring Part II – Rigid Steel Conduits
IS: 9676	Reference Ambient Temperature for Electrical Equipment
IS:10028	Selection, Installation and Maintenance of Transformers
IS:371-1999	Ceiling roses
JEC : 61215 Ed 2 or latest	Crystalline silicon terrestrial photovoltaic (PV) modules - Design qualification and type approval
NFPA	National Fire Protection Association
RDSO/2009/EM/SP EC/0002 Rev. 1, Jan 2010	Manufacture and Supply of Single / Multicore 11/33kV grade XLPE insulated and PVC Sheathed Armoured / Unarmoured Power Cables for Electric Supply Purposes in Indian Railways. Issued by RDSO/Lucknow.
RDSO/2009/EM/SP EC/0002 Rev. 1, Jan. 2010	Manufacture and Supply of Single / Multicore 11/33kV grade XLPE insulated and PVC Sheathed Armoured / Unarmoured Power Cables for Electric Supply Purposes in Indian Railways. Issued by RDSO/Lucknow.
RDSO/2009/EM/SP EC/0006 Rev. 1, Jan. 2010	Manufacture & Supply of Armoured & Unarmoured Single / Multicore XLPE Insulated & PVC Sheathed Cable for Working Voltages up to and Including 1100V. Issued by RDSO/Lucknow.
RDSO/PE/SPEC/AC /0100-2008 (REV. 0) Amdt-1	Specification for Double Capped Tubular T5 Fluorescent Lamps and Its Fitting with Electronic Ballast
RDSO/PE/SPEC/PS /0123 (REV. 0)-2009	Provisional Specification for Energy Efficient LED Based Luminaires for Street Lighting and Platform Lighting.

Safety	Europe EN 500091-1
SP 31: 1986	Special Publication: Chart on Treatment for Electric Shock
Specification No. RDSO/PE/ SPEC/PS/0092- 2008 (Rev. '0')Amdt- 4	Grid connect solar generating system for INDIAN RAILWAYS
Specification No. RDSO/PE/ SPEC/PS/0023- 2001(Rev-0) Amndt. No.3	Technical specification for fault tolerant Uninterrupted Power Supply (UPS) System for PRS, EDP Centres and Other similar requirements of online UPS system for INDIAN RAILWAYS
Emission and Immunity	Europe: EN 500091-2
IS 15885, 16101, 16102, 16103, 16104, 16105, 16106, 16107 (Part I & II), 16108 and relevant RDSO specifications	All Indian standards on LED based systems for general illumination relevant to the applications and it future amendments.

Attachment 20.7: Indicative Scheme for Auxiliary Power Supply System

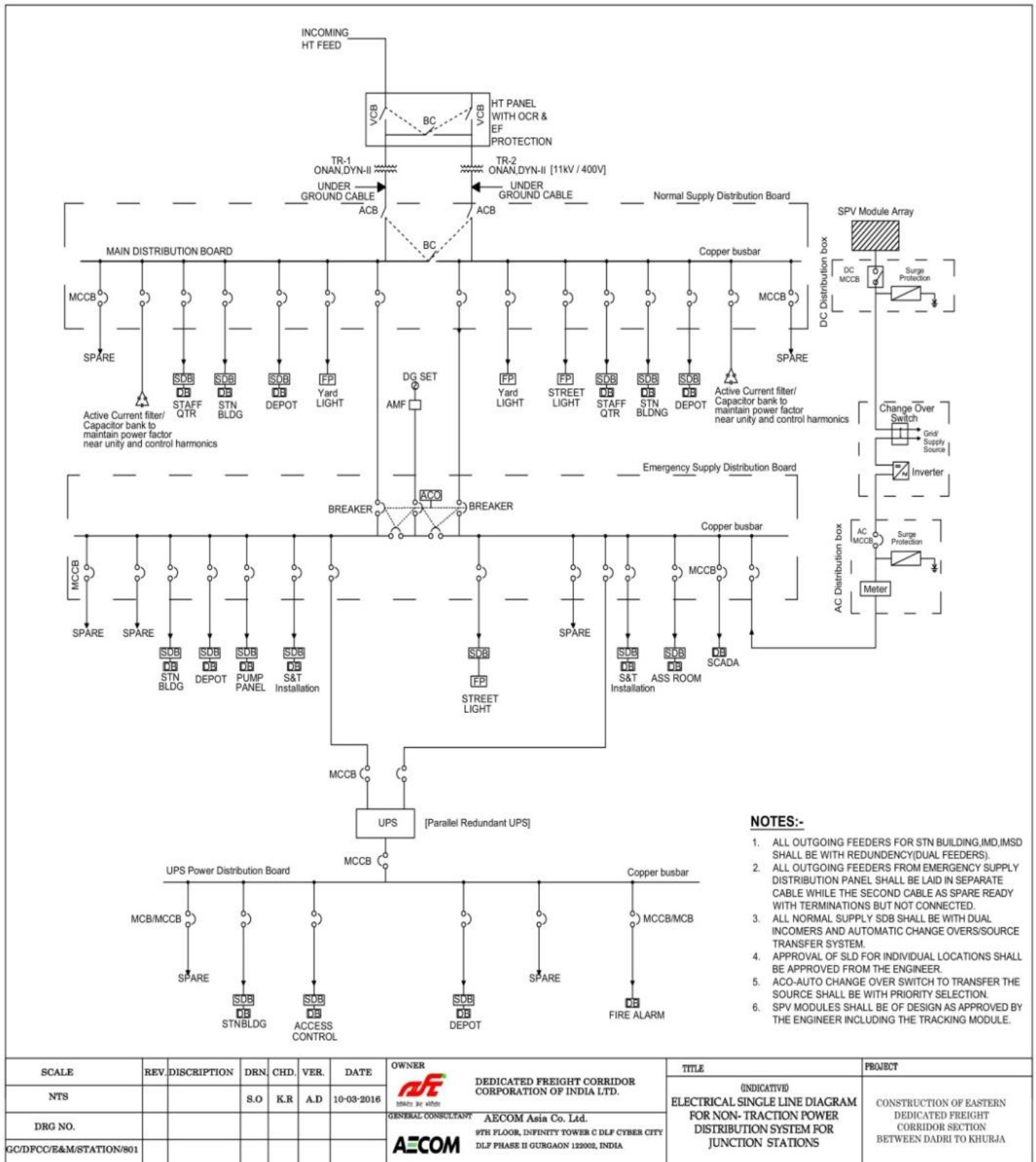

(End of Chapter-20)



BID DOCUMENT FOR

Design, Supply, Construction, Installation, Testing and Commissioning of 2x25kV AC Electrification, Signalling & Telecommunication, E&M and Associated Works on Design-Build Lump Sum Basis for Dadri-Khurja Section (approximately 47 Route Km of Double Line) of Eastern Dedicated Freight Corridor

SYSTEMS WORKS CONTRACT PACKAGE 105

Issued on: 14.06.2017

ICB No.: HQ/SYS/EC/D-B/Dadri– Khurja

(Part-3)

**EMPLOYER: DEDICATED FREIGHT CORRIDOR CORPORATION OF INDIA LTD
(A GOVERNMENT OF INDIA ENTERPRISE)**

MINISTRY OF RAILWAYS

COUNTRY: INDIA

Table of Contents

PART 1 – Bidding Procedures

Section I. Instructions to Bidders

Section II. Bid Data Sheet

Section III. Evaluation and Qualification Criteria (Following Prequalification)

Section IV. Bidding Forms

Section V. Eligible countries

PART 2 – Employer’s Requirements

Section VI. Employer’s Requirements

Volume 1: General Specifications

Volume 2: Particular Specifications – 2x25 kV, AC Traction Electrification and Associated Works

Volume 3: Particular Specifications – Signalling Works

Volume 4: Particular Specifications – Telecommunication Works

Volume 5: Particular Specifications – E&M and Associated Works

PART 3 – Conditions of Contract and Contract Forms

Section VII. General Conditions (GC) As per FIDIC Yellow Book 1999-Edition

Section VIII. Particular Conditions

- *Appendix to Tender*

Section IX. Contract Forms

PART 4 – Reference Documents

1. Alignment Plans, Yard Plans and Building Plans
2. Power Supply, Distribution, OHE and SCADA system Schemes & layouts and S&T Drawings
3. DFCC-Environmental Assessment Report for Khurja - Dadri Section
4. Environmental Management Framework(EMF) for EDFC
5. DFCC– Resettlement Action Plan for Khurja- Dadri Section
6. DFCC-SHE Manual
7. Specification for 12000hp locomotive and Tractive effort Curve
8. IR’s Transmission line Network and DFCCIL’s Traction Sub Station (TSS) Connectivity

Section VII. General Conditions (GC) As per FIDIC Yellow Book 1999-Edition

GENERAL CONDITIONS OF CONTRACT (GC) REFER TO

The conditions of Contract comprise the “General Conditions” which form part of the conditions of Contract for Plant and Design Build first edition 1999 published by the Federation Internationale Des Ingenieurs – Conseils (FIDIC) and the following “Particular Conditions” which include amendments and addition to such General Conditions.

Copies of the above FIDIC publication i.e. “Conditions of Contract for Plant and Design Build” can be obtained from

International Federation of Consulting Engineers
FIDIC Bookshop – Box- 311 – CH – 1215 Geneva 15 Switzerland
Fax: +41 22 799 49 054
Telephone: +41 22 799 49 01
E-mail: fidic@fidic.org
www.fidic.org

Section VIII. Particular Conditions

The Conditions of Contract comprise the “**General Conditions**”, which form part of the “Conditions of Contract for Plant and Design Build for Electrical and Mechanical, and for Building and Engineering Works designed by the Contractor”, First Edition, 1999 published by the Fédération Internationale des Ingénieurs-Conseils (**FIDIC**), and the following “**Particular Conditions**”, which include amendments and additions to such General Conditions. The General Conditions are incorporated herein by reference only and are not set out at length. The Contractor is deemed to have obtained for himself and read and fully understood the General Conditions in their entirety. The following Particular Conditions shall supplement the General Conditions in Section VII. Whenever there is a conflict, the provisions herein shall prevail over those in the General Conditions.

Clause	PROVISIONS
Sub-Clause 1.1.3.1	Insert the words “Second Stage” before the word “Tender” in second line of the Sub-Clause 1.1.3.1.
Sub-Clause 1.1.3.10	Insert additional Sub-Clause 1.1.3.10 “Milestone” means the completion of a part of the Works, or the occurrence of an identified event.
Sub-Clause 1.1.3.11	Insert additional Sub-Clause 1.1.3.11 “Stage” means the part of the Works identified as such and more particularly described in the Price Schedules, Part I Section IV Bidding Forms.
Sub-Clause 1.1.3.12 Reference to Period	Insert additional Sub-Clause 1.1.3.12: “Reference to period” means period commencing ‘from’ a specified day or date and ‘till’ or ‘until’ a specified day or date shall include both such days and dates.”
Sub-Clause 1.1.6.6	Delete the contents of this clause and replace as under: “ Performance Security ” means the security as identified under Sub-Clause 4.2. “ ESHS Performance Security ” means the security for Environment, Social, Health and Security (ESHS) as identified under Sub-Clause 4.2. ”
Sub-Clause 1.1.6.9	Delete the existing clause and substitute with the following: “ Variation means any change to the Employer’s

	<p>Requirements with reference to change in Scope of Works, Design Criteria & Specifications and Criteria for the Testing & Performance of the completed Works specified in the Employer’s Requirements or the Works, which is instructed or approved as a variation under clause 13 [Variations and Adjustment].”</p>
<p>Sub-Clause 1.1.6.10 General Clauses Act 1897</p>	<p>Insert the following Sub-Clause 1.1.6.10: “Any word or expression used in this Contract shall, unless otherwise defined or construed in this Contract, bears its ordinary English meaning and, for these purposes, the General Clauses Act 1897 shall not apply.”</p>
<p>Sub-Clause 1.2. Interpretation</p>	<p>Insert the following sub-paragraphs after sub-paragraph (d): “(e) the word ‘tender’ is synonymous with ‘bid’, and ‘tenderer’ with ‘bidder’ and the words ‘tender documents’ with ‘bidding documents’.”</p>
<p>Sub-Clause 1.3 Communication</p>	<p>Add the following paragraph at the end of this Sub-Clause: “In this Contract, unless the context otherwise requires, any Contract, consent, approval, authorisation, notice, communication, information or report required under or pursuant to this Contract from or by any Party or the Engineer shall be valid and effective only if it is in writing under the hand of a duly authorised representative of such Party or the Engineer, as the case may be, in this behalf and not otherwise”</p>
<p>Sub-Clause 1.5 Priority of Document</p>	<p>Delete sub paragraphs (a) to (h) and replace with the following: “1) The Contract Agreement; 2) Letter of Acceptance; 3) Minutes of meeting of pre-award clarifications / negotiations after opening of the Second Stage Bid, if any; 4) Addenda to Bidding Documents, if any 5) (i) Letter of Bid-(Two Stage Bidding, Second Stage Bid), (ii) Appendix to Bid (Percentage Breakup of Lump Sum</p>

	<p>Bid Price for local & foreign currencies</p> <p>(iii) Price Schedules submitted by the Contractor;</p> <p>6) Appendix to Tender;</p> <p>7) Particular Conditions;</p> <p>8) General Conditions;</p> <p>9) Memorandum titled ‘Changes Required Pursuant to First Stage Evaluation’;</p> <p>10) (i) Employer’s Requirements; (a) Particular Specifications (b) General Specifications (ii) Letter of Bid (First Stage Bidding)</p> <p>11) Contractor’s Updated Technical Proposal;</p> <p>12) Part 4 (Reference Documents) of Bidding document; and</p> <p>13) Any other documents forming part of the Employer’s requirements and Bidding documents.”</p>
<p>Sub- clause 1.7 Assignment</p>	<p>Delete Sub-clause 1.7 (a)</p>
<p>Sub- clause 1.9 Errors in Employer’s Requirements</p>	<p>Delete Sub-clause 1.9 and replace with:</p> <p>“If the Contractor suffers delay and/or incurs Cost as a result of an error in the Employer's Requirements with reference to purpose, scope, design and /or other technical criteria for the works and an experienced Contractor exercising due care would not have discovered the error when scrutinizing the Employer's Requirements with respect to purpose, scope, design and/or other technical criteria for the works under Sub-Clause 5.1 [General Design Obligations], the Contractor shall give notice to the Engineer and shall be entitled subject to Sub-Clause 20.1 [Contractor's Claims] to:</p> <p>(a) an extension of time for any such delay, if completion is or will be delayed, under Sub-Clause 8.4 [Extension of Time for Completion], and</p> <p>(b) payment of any such Cost plus reasonable profit, which shall be included in the Contract Price.</p> <p>After receiving this notice, the Engineer shall proceed in accordance with Sub-Clause 3.5 [Determinations] to agree or</p>

	<p>determine</p> <p>(i) whether an experienced Contractor could not have discovered the error?</p> <p>(ii) if the answer to the matter stated above in paragraph (i) is yes, to what extent the Contractor could not reasonably have discovered the error; and</p> <p>(iii) the matters described in sub-paragraphs (a) and (b) above to the extent under paragraph (ii) above.”</p>
<p>Sub- clause 1.14 Joint and Several Liability</p>	<p>Delete Sub- clause (b) and replace with:</p> <p>“In case of a joint venture or consortium or group of two or more persons performing the Contract, one of the members shall be nominated as the lead partner, who shall be the point of contact for the Employer. Each member of the joint venture or consortium or group of two or more persons shall furnish a power of attorney in favour of the lead partner to take all actions on behalf of the joint venture or consortium and bind the joint venture or consortium. However, the nomination of such lead partner shall not in any way affect the joint and several liability of the joint venture or consortium members under (a) above.”</p>
<p>New Sub- clause 1.15 Inspections and Audits by the Bank</p>	<p>Add New Sub-Clause 1.15:</p> <p>“The Contractor shall permit, and shall cause its Subcontractors and sub-consultants to permit, the Bank and/or persons appointed by the Bank to inspect the Site and all accounts and records relating to the performance of the Contract and the submission of the Bid, and to have such accounts and records audited by auditors appointed by the Bank if requested by the Bank. The Contractor’s and its Subcontractors’ and sub-consultants’ attention is drawn to Sub-Clause 1.16 [Fraud and Corruption] which provides, inter alia, that acts intended to materially impede the exercise of the Bank’s inspection and audit rights provided for under Sub-Clause 1.15 constitute a prohibited practice subject to contract termination (as well as to a determination of ineligibility pursuant to the Bank’s prevailing sanctions procedures)”</p>
<p>New Sub- clause 1.16 Fraud & Corruption</p>	<p>Add New Sub-Clause 1.16:</p> <p>“If the Employer determines that the Contractor and/or any of its personnel, or its agents, or its Subcontractors, sub-consultants, services providers, suppliers and/or their</p>

employees has engaged in corrupt, fraudulent, collusive coercive, or obstructive practices, in competing for or in executing the Contract, then the Employer may, after giving 14 days notice to the Contractor, terminate the Contractor's employment under the Contract and expel him from the Site, and the provisions of Clause 15 shall apply as if such expulsion had been made under Sub-Clause 15.2.

For the purposes of this Sub-Clause,

- (i) “corrupt practice” is the offering, giving, receiving or soliciting, directly or indirectly, of anything of value to influence improperly the actions of another party¹;
- (ii) “fraudulent practice” is any act or omission, including a misrepresentation, that knowingly or recklessly misleads, or attempts to mislead, a party to obtain a financial or other benefit or to avoid an obligation²;
- (iii) “collusive practice” is an arrangement between two or more parties³ designed to achieve an improper purpose, including to influence improperly the actions of another party;
- (iv) “coercive practice” is impairing or harming, or threatening to impair or harm, directly or indirectly, any party⁴ or the property of the party to influence improperly the actions of a party;
- (v) “obstructive practice” is
 - (aa) deliberately destroying, falsifying, altering or concealing of evidence material to the investigation or making false statements to investigators in order to materially impede a Bank investigation into allegations of a corrupt, fraudulent, coercive or collusive practice; and/or threatening, harassing or intimidating any party to

¹ “Another party” refers to a public official acting in relation to the procurement process or contract execution]. In this context, “public official” includes World Bank staff and employees of other organizations taking or reviewing procurement decisions.

² “Party” refers to a public official; the terms “benefit” and “obligation” relate to the procurement process or contract execution; and the “act or omission” is intended to influence the procurement process or contract execution.

³ “Parties” refers to participants in the procurement process (including public officials) attempting to establish bid prices at artificial, non competitive levels.

⁴ “Party” refers to a participant in the procurement process or contract execution.

	<p>prevent it from disclosing its knowledge of matters relevant to the investigation or from pursuing the investigation, or</p> <p>(bb) acts intended to materially impede the exercise of the Bank’s inspection and audit rights provided for under Sub-Clause 1.15.”</p>
<p>Sub- clause 2.1 Right of Access to Site</p>	<p>Replace the words “Performance Security” with “Performance Security and ESHS Performance Security” in the last line of the 1st Paragraph.</p> <p>Insert ‘Formation, Track’ between the words ‘plant’ and ‘or’ in 5th line of paragraph 1.</p> <p>Delete the contents of Sub-Clause (b) in para 3 and replace with:-</p> <p>“Payment of any such cost plus reasonable profit subject to a maximum of Rs.2000.00 (Two Thousand) per day for every km. For length less than a kilometre pro-rata amount shall be calculated provided further that if such delay in handing over does not affect the execution of Permanent Works under this Contract, provisions under para 2.1(b) of this sub-clause shall not apply</p>
<p>Sub-Clause 3.1 Engineer’s Duties and Authorities</p>	<p>Delete 4th paragraph “However, whenever given approval” of this Sub-Clause.</p> <p>Add the following at the end of this Sub-Clause:</p> <p>“Notwithstanding anything contained hereinabove, the Engineer is required to obtain specific written approval of the Employer before exercising specific authorities as listed below:</p> <ul style="list-style-type: none"> i) Consenting to proposed Subcontractors / Specialized sub-contractors pursuant to Sub-Clause 4.4 (b); ii) Giving consent to the Contractor’s proposed Designer pursuant to Sub-Clause 5.1; iii) Giving approvals to the Contractor’s documents under Sub-Clause 5.2 as specified in Employer’s Requirement; iv) Determination of any additional payment in accordance with Sub-Clause 3.5 read with Sub-Clause 2.5 & 20.1. v) Determination of Extension of Time for Completion in accordance with Sub-Clause 8.4 read with Sub-Clause 20.1;

	<p>vi) Taking action in connection with variations in the Employer’s Requirements which have been initiated by the Employer.</p> <p>vii) Issuing of Taking-Over Certificate pursuant to Clause 10;</p> <p>viii) Instructing or approving Variations pursuant to Sub-Clauses 13.1, 13.2 and 13.3 except;</p> <p>a. In an emergency affecting the safety of life or of the works or of adjoining property or track, he may, without relieving the Contractor of any of his duties and responsibility under the Contract, instruct the Contractor to execute all such things as may, in the opinion of the Engineer, be necessary to abate or reduce the risk.</p> <p>In case the emergency mentioned above occurs on account of failure of Contractor, by way of not adhering to the sound industry practice or not taking adequate safety precautions, then no amounts shall be paid to the Contractor for attending to such emergencies.</p> <p>b. If the variation is within a limit of 0.1% of original contract price in a single instance and combined with all variation orders previously issued, increase the original Contract Price by less than 2%.</p> <p>The Employer shall, on the best effort basis, give its decision on Engineer’s proposal of variation within 21 (twenty one days) of the receipt of the proposal.”</p>
<p>Sub-clause 4.1 Contractor’s General Obligations</p>	<p>Insert in the fifth paragraph after the words “The Contractor shall, whenever required by the Engineer, submit details of the arrangements and methods which the Contractor proposes to adopt for the execution of the Works.”</p> <p>“The Contractor shall not commence any Works, including mobilization and/or pre-construction activities (e.g. limited clearance for haul roads, site accesses and work site establishment, geotechnical investigations or investigations to select ancillary features such as quarries and borrow pits), unless the Engineer is satisfied that appropriate measures are in place to address environmental, social, health and safety risks and impacts. At a minimum, the Contractor shall apply the Management Strategies and Implementation Plans and Code of Conduct, submitted as part of the Bid and agreed as part of the Contract. The Contractor shall submit, on a</p>

	<p>continuing basis, for the Engineer’s prior approval, such supplementary Management Strategies and Implementation Plans as are necessary to manage the ESHS risks and impacts of ongoing works. These Management Strategies and Implementation Plans collectively comprise the Contractor’s Environmental and Social Management Plan (C-ESMP). The C-ESMP shall be approved prior to the commencement of construction activities (e.g. excavation, earth works, bridge and structure works, stream and road diversions, quarrying or extraction of materials, concrete batching and asphalt manufacture). The approved C-ESMP shall be reviewed, periodically (but not less than every six (6) months), and updated in a timely manner, as required, by the Contractor to ensure that it contains measures appropriate to the Works activities to be undertaken. The updated C-ESMP shall be subject to prior approval by the Engineer.</p>
<p>Sub-clause 4.2 Performance Security</p>	<p>Delete the contents of Paragraph 4.2 and replace as under:</p> <p>4.2 Performance Security and ESHS Performance Security</p> <p>The Contractor shall obtain (at his cost) a Performance Security for proper performance and ESHS Performance Security for compliance with the Contractor’s ESHS obligations, in the amount and currencies stated in the Appendix to Tender. If an amount is not stated in the Appendix to Tender, this Sub-Clause shall not apply.</p> <p>The Contractor shall deliver the Performance Security and ESHS Performance Security to the Employer within 28 days after receiving the Letter of Acceptance, and shall send a copy to the Engineer. The Performance Security and ESHS Performance Security shall be issued by an entity and from within a country (or other jurisdiction) approved by the Employer, and shall be in the form annexed to the Particular Conditions or in another form approved by the Employer.</p> <p>The Contractor shall ensure that the Performance Security and ESHS Performance Security are valid and enforceable until the Contractor has executed and completed the Works and remedied any defects. If the terms of the Performance Security and ESHS Performance Security specify its expiry date, and the Contractor has not become entitled to receive the Performance Certificate by the date 28 days prior to the expiry date, the Contractor shall extend the validity of the Performance Security and ESHS Performance Security until the Works have been completed and any defects have been</p>

	<p>remedied.</p> <p>The Employer shall not make a claim under the Performance Security and ESHS Performance Security, except for amounts to which the Employer is entitled under the Contract in the event of:</p> <p>(a) failure by the Contractor to extend the validity of the Performance Security and/or ESHS Performance Security as described in the preceding paragraph, in which event the Employer may claim the full amount of the Performance Security and/or ESHS Performance Security, as the case may be.</p> <p>(b) failure by the Contractor to pay the Employer an amount due, as either agreed by the Contractor or determined under Sub-Clause 2.5 [Employer’s Claims] or Clause 20 [Claims, Disputes and Arbitration], within 42 days after this agreement or determination,</p> <p>(c) failure by the Contractor to remedy a default within 42 days after receiving the Employer’s notice requiring the default to be remedied, or</p> <p>(d) circumstances which entitle the Employer to termination under Sub-Clause 15.2 [Termination by Employer], irrespective of whether notice of termination has been given in which event the Employer shall forfeit the amount of the Performance Security and ESHS Performance Security as indicated in Sub-Clause 15.4.”.</p> <p>In case the Employer makes a claim on the Performance Security and ESHS Performance Security, which it was not entitled to make, the Employer shall forthwith refund such amount of claim to the Contractor. The Employer shall return the Performance Security and ESHS Performance Security to the Contractor within 21 days after receiving a copy of the Performance Certificate.</p> <p>“</p>
<p>Sub-clause 4.4 Subcontractors</p>	<p>“Delete the first line of Sub-Clause 4.4 and substitute with the following:</p> <p>“The Contractor shall not subcontract Works of value more than 30% of the Accepted Contract Amount in addition to the Works for which Specialized Subcontractor(s) are named in the Contract.”</p>

	<p>Add the following at the end of the Sub-Clause:</p> <p>“The Employer at his discretion may permit the replacement of Specialized Subcontractors, named in the Contract, provided new Specialized Subcontractor(s) have required qualification.”</p>
<p>Sub-clause 4.7 Setting Out</p>	<p>Delete paragraph 2, 3 & 4 of Sub-clause 4.7 and substitute with the following:</p> <p>“Accuracy of these specified items of reference shall be deemed to have been verified by the Contractor. Accordingly, the Contractor shall have no right to claim towards time or cost caused due to errors in these specified items of reference.”</p>
<p>Sub-Clause 4.10 Site Data</p>	<p>Add at the end of paragraph 1 of Sub-Clause 4.10.</p> <p>“Accordingly, the Contractor shall have no claim in this regard.”</p> <p>In paragraph 2 of Sub-Clause 4.10.</p> <p>Delete the words “To the extent which was practicable (taking account of cost and time)”.</p> <p>Start the word “‘the’ with a capital letter.”</p> <p>Delete “To the same extent” from the fourth line and Start the word “the” with a capital letter.</p>
<p>Sub-Clause 4.11 Sufficiency of the Accepted Contract Amount</p>	<p>Add the following after Sub-Clause 4.11</p> <p>“DFCC project being funded by the World Bank, qualifies for exemption from payment of custom duty and Excise duty on goods supplied/intended to be supplied to the Project in terms of Government of India’s Customs notification no. 84/97 – customs dated 11.11.1997 and Central Excise Notification no. 108/95-CE dated 28.08.1995 (read along with all subsequent amendments) respectively, provided the goods brought in to the project are not withdrawn by the supplier or the Contractor.</p> <p>Under various notifications of the Department of Excise and Customs, Government of India, goods brought in to the project funded by the International Bank of Reconstruction and Development (IBRD) and / or awarded after conducting process under the International Competitive Bidding are exempt from Customs and Excise duties and / or are eligible for Deemed Export Benefits, provided the said goods are not withdrawn by the supplier or Contractor.</p>

	<p>The certificates required for claiming exemption of customs duty and excise duty and / or for claiming deemed export benefits on goods by the Contractor shall be issued by the Employer. The Contractor shall be solely responsible for obtaining such duty exemptions and / or deemed export benefits and in case of failure to avail such benefits for any reasons whatsoever; the Employer shall not reimburse any such duties.</p> <p>The above stated certificate(s) shall be issued for the bonafide and reasonable quantities of goods to be used as input in the construction of Works, on the recommendations of the Engineer taking in to account the Work Programme [Sub-Clause 8.3 of the Conditions of Contract] and approved methodology.</p> <p>Any delay in procurement of the goods as a result of any delay, in the issuing of the above mentioned certificates and / or availing the exemptions, shall not be entertained as a reason for granting any Extension of Time for Completion and / or additional cost.</p> <p>Service Tax department vide their Notification No. 25/2012-Service Tax dated 20.06.2012, has exempted the services by way of construction, erection, commissioning, or installation of original works pertaining to railways. The Bidder shall examine to make his own assessment in regard to service tax liability in the Contract. No separate Service Tax reimbursement will be made by the Employer.</p> <p>No customs duty or excise duty or any tax, fee, royalty etc. will be reimbursed by the Employer.”</p>
<p>Sub-clause 4.12 Unforeseeable Physical Conditions</p>	<p>Delete the Sub-Clause and Substitute with the following:</p> <p>“In this Sub-Clause, "physical conditions" means man-made or natural physical conditions including sub-surface and hydrological conditions which the Contractor encounters at Site during the execution of the Works.</p> <p>Except as otherwise stated in the Contract:</p> <p>(a) the Contractor accepts total responsibility for having foreseen all difficulties and physical conditions; and</p> <p>(b) the Contract Price shall not be adjusted to take account of any unforeseen physical conditions.”</p>
<p>Sub-Clause 4.21 Progress Reports</p>	<p>Delete Sub-Clause (g) and replace with the following:</p>

	<p>“the Environmental, Social, Health and Safety (ESHS) metrics set out in Appendix 8</p> <p>Add another paragraph (i) at the end of Sub-Clause 4.21 as follows:</p> <p>“The Contractor shall provide immediate notification to the Engineer of incidents in the following categories. Full details of such incidents shall be provided to the Engineer within the timeframe agreed with the Engineer.</p> <ul style="list-style-type: none"> (a) confirmed or likely violation of any law or international agreement; (b) any fatality or serious (lost time) injury; (c) significant adverse effects or damage to private property (e.g. vehicle accident, damage from fly rock, working beyond the boundary) (d) major pollution of drinking water aquifer or damage or destruction of rare or endangered habitat (including protected areas) or species; or (e) any allegation of sexual harassment or sexual misbehavior, child abuse, defilement, or other violations involving children.
<p>Sub-clause 4.25 Change of Control</p>	<p>Insert the following additional Sub-clause</p> <p>“Any change in Control of the Contractor, or in case if the Contractor is a JV/consortium of members, any change of Control of any of the members of the JV/consortium, shall require prior approval of the Employer. Such approval shall not be unreasonably withheld, unless, such change in Control, if had taken prior to the date of submission of the bid, would have rendered the Contractor or any such member in case the Contractor is a JV/consortium, ineligible to bid for the Project in terms of the Instructions to Bidders or in the opinion of the Employer such change in Control shall jeopardize national security or interest.</p> <p>For the purposes of this clause “Control” shall mean the possession, directly or indirectly, of the power to direct or cause the direction of the management and affairs of such person, whether through the legal and beneficial ownership of more than 50% (fifty per cent) of the voting securities of such person, by agreement or otherwise or the power to elect majority of directors, partners or other individuals exercising similar authority with respect to such person.”</p>

<p>Sub-clause 5.1 General Design Obligations</p>	<p>Delete Sub-Clause 5.1 and substitute with the following:</p> <p>“The Contractor shall carry out, and be responsible for, the design of the Works. Design shall be prepared by qualified designers who are engineers or other professionals who comply with the criteria (if any) stated in the Employer's Requirements with reference to purpose, scope, design and/or other technical criteria for the works. Unless otherwise stated in the Contract, the Contractor shall submit to the Engineer for consent the name and particulars of each proposed designer and design Subcontractor.</p> <p>The Contractor warrants that he, his designers and design Subcontractors have the experience and capability necessary for the design. The Contractor undertakes that the designers shall be available to attend discussions with the Engineer at all reasonable times, until the expiry date of the relevant Defects Notification Period.</p> <p>Upon receiving notice under Sub-Clause 8.1 [<i>Commencement of Works</i>], the Contractor shall scrutinise the Employer's Requirements with reference to purpose, scope, design and /or other technical criteria for the Works. (including design criteria and calculations, if any). Within the period stated in the Appendix to Tender, calculated from the Commencement Date, the Contractor shall give notice to the Engineer of any error, fault or other defect found in the Employer's Requirements with reference to purpose, scope, design and /or other technical criteria for the works.</p> <p>After receiving this notice, the Engineer shall determine whether Clause 13 [<i>Variations and Adjustments</i>] shall be applied, and shall give notice to the Contractor accordingly. If and to the extent that (taking account of cost and time) an experienced Contractor exercising due care would have discovered the error, fault or other defect when examining the Site and the Employer's Requirements with reference to purpose, scope, design and/or other technical criteria for the works before submitting the Tender, the Time for Completion shall not be extended and the Contract Price shall not be adjusted.”</p>
<p>Sub-Clause 6.12 Employment of Foreign Nationals</p>	<p>Insert the following New Sub-Clause:</p> <p>“The Contractor acknowledges, agrees and undertakes that employment of foreign personnel by the Contractor and/or its Subcontractors may be subject to grant of requisite regulatory permits and approvals including employment/residential visas and work permits, required if any, and the obligation to</p>

	<p>apply for and obtain the same shall always be of the Contractor. Notwithstanding anything to the contrary contained in the Contract, refusal of or inability to obtain any such permits and approvals by the Contractor or any of its Subcontractors shall not constitute Force Majeure event, and shall not in any manner excuse the Contractor from the performance and discharge of its obligations and liabilities under the Contract.</p> <p>The Employer, on a best effort basis, will provide reasonable assistance in obtaining such visas and permits, but without thereby incurring any liability whatsoever towards the Contractor.”</p>
<p>Sub-Clause 6.9 Contractor's Personnel</p>	<p>Add Paragraph (e) after end of paragraph (d) as follows:</p> <p>“undertakes behavior which breaches the Code of Conduct (ESHS) (e.g. spreading communicable diseases, sexual harassment, gender based violence, illicit activity or crime).”</p> <p>After the sentence: <i>“If appropriate, the Contractor shall then appoint (or cause to be appointed) a suitable replacement person.”</i> insert a new paragraph below the last paragraph</p> <p>“The Contractor’s Personnel includes Key Personnel. If the Contractor intends to replace a Key Personnel, the Contractor shall, not less than 30 days before the intended date of replacement, give notice to the Engineer, the name, address, academic qualifications and relevant experience of the intended replacement Key Personnel. The Contractor shall not, without the prior consent of the Engineer, revoke the appointment of the Key Personnel or appoint a replacement.”</p>
<p>Sub-Clause 7.4 Testing</p>	<p>Insert the following at the end of this Sub-Clause:</p> <p>“The Contractor shall not be released from any liability or obligation under the Contract by reason of any such inspection or testing or witnessing of testing, or by the submission of reports of inspection or testing to the Engineer.”</p>
<p>Sub-Clause 8.2 Time for Completion</p>	<p>Delete this Sub-Clause and substitute with the following:</p> <p>“Whole of the Works shall be completed within 640 (Six Hundred Forty) days from the Commencement Date.</p> <p>Milestone-1: 300 (Three Hundred) days from the Commencement Date</p> <p>Prior to the occurrence of Milestone-1, the Contractor shall</p>

	<p>have commenced the activities of the Permanent Works entitling him a payment of at least 10% of the Accepted Contract Amount.</p> <p>Note: 10% of the Accepted Contract Amount shall not include advance payment made to the Contractor as per Clause 14.2 of GC.</p> <p>Milestone-2: 500 (Five Hundred) days from the Commencement Date</p> <p>Prior to the occurrence of Milestone-2, the Contractor shall have achieved the Permanent Works entitling him to a payment of at least 70% of Accepted Contract Amount.</p> <p>Milestone-3: 575 (Five Hundred Seventy Five) days from the Commencement Date</p> <p>Prior to the occurrence of Project Milestone-3, the Contractor shall have completed the Tests on Completion pursuant to Clause 9 of the Conditions of Contract including integrated Testing required, complete in all respects as per Employer’s Requirement mentioned in the Contract.</p> <p>Milestone-4: 640 (Six Hundred Forty) days from the Commencement Date</p> <p>Prior to the occurrence of Milestone-4, the Contractor shall have completed all necessary Works required as per the Contract including certification of installation by an authority nominated by the Employer and Taking Over of the entire Works pursuant to Clause 10 of the Conditions of Contract.”</p>
<p>Sub-Clause 8.3 Programme</p>	<p>Insert the following after 1st sentence in paragraph 1: “Each programme shall take into account the progress of the Works under execution of Civil Works Contract Package 302 of the same section under the same Project [Eastern Dedicated Freight Corridor Project-3].”</p> <p>Delete paragraph 3 of Sub- Clause 8.3 “The Contractor shall [Variation Procedure].”</p>
<p>Sub-Clause 8.4 Extension of Time for Completion</p>	<p>Delete Sub-Clauses (c)</p> <p>Delete “(d)” and substitute as under:- “Unforeseeable shortages in the availability of Goods caused due to changes in laws in accordance with the provisions of Sub-Clause 13.7”</p> <p>Add Sub-Clause (f) – “A cause of delay in handing over possession of Site in accordance with the provisions of Sub-</p>

	clause 2.1”
<p>Sub-Clause 8.7 Delay Damages</p>	<p>Delete Sub-Clause 8.7 and substitute with the following:</p> <p>“The Contractor shall complete the Works in accordance with the Time for Completion of Works set forth in Sub-Clause 8.2 [Time for Completion]. In the event that the Contractor fails to achieve any Milestone on the date set forth for such Milestone in the Time for Completion, unless such failure has occurred due to Force Majeure or for reasons solely attributable to the Employer, the Contractor shall pay Delay Damages to the Employer in a sum calculated at the rate stated in the Appendix to Tender until such Milestone is achieved; provided that if the construction period for any or all Milestones is extended in accordance with the provisions of this Contract, the dates set forth in the Sub-Clause 8.2 [Time for Completion] shall be deemed to be modified accordingly and the provisions of this Sub-Clause shall apply as if Appendix to Tender has been amended accordingly; provided further that in the event Whole of the Works are completed within the Time for Completion as stated in the Sub-Clause 8.2 [Time for Completion] of the Particular Conditions, the Delay Damages paid under this Sub-Clause shall be refunded by the Employer to the Contractor, but without any interest thereon.</p> <p>It is agreed that recovery of Damages under this Sub-Clause shall be without prejudice to the rights of the Employer under this Contract including the right of Termination thereof.</p> <p>The Parties hereby accept that delays cause loss to the public and the national economy for whose benefit the Works is meant, and that the loss is not susceptible to precise measurement. The Parties hereby agree that the rate of Delay Damages agreed in this Clause 8.7 is a reasonable pre-determined amount, and that the Delay Damages are not by way of penalty. Further, the total amount of Delay Damages under Sub-Clause 8.7 shall not exceed the maximum amount of delay damages (if any) stated in the Appendix to Tender.”</p>
<p>Sub Clause 8.8 Suspension of Works</p>	<p>Delete Sub-Clause 8.8, and Substitute with the following:</p> <p>“In the event of the failure of the Contractor to duly and effectively perform any of its obligations or to perform proper execution of the Works in accordance with the provisions of this Contract, the Engineer may by notice require the Contractor to suspend forthwith the performance</p>

of any obligations under the Contract or the whole or any part of the Works.

The Contractor shall, pursuant to the notice under this Sub-Clause, suspend the Works or any part thereof for such time and in such manner as may be specified by the Engineer and thereupon carry out remedial measures to rectify the defects and secure the safety of the suspended works. The Contractor may by notice require the Engineer to inspect such remedial measures forthwith, with a request that the suspension hereunder may be revoked. The Engineer shall either revoke such suspension or instruct the Contractor to carry out such other and further remedial measures as may be necessary and the procedure set forth in this Sub-Clause shall be repeated until the suspension hereunder is revoked.

All reasonable costs incurred for maintaining and protecting the Works and remedying the defects during the period of suspension shall be borne by the Contractor.

During the period of Suspension, the Employer may at its own discretion, on behalf of the Contractor, undertake to fulfill any of the Contractor's obligations for remedying and rectifying the cause of Suspension. Provided that any cost incurred by the Employer in fulfilling the obligations of the Contractor for the remedying or rectifying the cause of Suspension shall be borne by the Contractor. The Employer shall have the right to deduct any such expense incurred and another twenty percent thereof as Damages from any payment due or to be due to the Contractor under the provisions of this Contract.

If and to the extent the cause for the suspension is the responsibility of the Contractor, the following Sub-Clauses 8.9, 8.10, and 8.11 shall not apply.

The Contractor shall not be entitled to extra cost (if any), incurred by him, during the period of suspension of Work, if such suspension is:

- (a) provided for in the Contract; or
- (b) necessary for proper execution of Works or by reasons of weather condition or by some default on the part of the Contractor; or
- (c) necessary for the safety of Works or any part thereof;

	<p>or</p> <p>(d) necessary for the safety of adjoining public or other property or safety of the public or workmen or those who have to be at the site; or</p> <p>(e) to ensure safety and to avoid disruption of traffic and utilities, as also to permit fast repairs and restoration of any damaged utilities.”</p>
<p>Sub-Clause 10.2 Taking Over of Parts of the Works</p>	<p>Delete the Sub-Clause 10.2 in its entirety.</p>
<p>Sub-Clause 13.2 Value Engineering</p>	<p>After the Sub-Clause add the following ;-</p> <p>“The value engineering proposal shall not impair the essential character, functions or characteristics of the Work, including service life, economy of operation, ease of maintenance, desired appearance, or design, safety standards would not result in any reduction to the standard, or quality of works, or the performance of the Contractor and his obligations under the Contract.</p> <p>If the proposal of variation as a result of Value Engineering is approved, the reasonable share to be given to the Contractor shall be 30% of the net saving resulted due to Value Engineering.”</p>
<p>Sub-Clause 13.3 Variation procedure</p>	<p>Delete contents of sub-clause (a) and substitute with the following:a description of the proposed design and/or work to be performed, a programme for its execution and sufficient ESHS information to enable an evaluation of ESHS risks and impacts;”</p> <p>Add the following below the last paragraph:</p> <p>“For varied works of items due to variation as per Sub-Clause 1.1.6.9 determination of adjustment to the Contract Price shall be based on the following:</p> <ol style="list-style-type: none"> a. Inputs of man-days, machine hours and quantities of materials; b. (i) Prevailing market rates for Materials, hiring of equipment; (ii) Rates being paid by the Contractor for unskilled, semi-skilled and skilled worker as per the records maintained by the Contractor in accordance with the Laws; c. Contractor’s overheads and profit at the rate of 15

	<p>(fifteen) per cent of the cost arrived at on the basis of (a) and (b) above and;</p> <p>d. Applicable taxes.</p> <p>No price adjustment shall apply.</p> <p>The approval for Variation shall state the period of extension of time, if any, allowed for the Variation. If no extension of time is allowed, the same shall be stated.”</p>
<p>Sub-Clause 13.7 Adjustments for Changes in Legislation</p>	<p>Delete first paragraph of the Sub-Clause and Substitute with the following:</p> <p>“The Contract Price shall be adjusted to take account of any increase or decrease in Cost after the Base Date resulting from:</p> <ul style="list-style-type: none"> a. a change in the Laws of the Country (including the introduction of new Laws and the repeal or modification of existing Laws); or b. in the judicial or official governmental interpretation of such Laws, or c. the commencement of any Indian law which has not entered into effect until the Base Date; or d. any change in the rates of any of the Taxes or royalties on Materials and Services that have a direct effect on the Project <p>which affect the Contractor in the performance of its obligations under the Contract.</p> <p>Insert at the end of the Sub-Clause:</p> <p>If as a result of change in law, interpretation, or rates of taxes or royalties, the Contractor benefits from any reduction in costs for the execution of this Contract, save and except as expressly provided for in this Sub-Clause or in accordance with the provisions of this Contract, the Contractor shall, within [28] days from the date he becomes reasonably aware of such reduction in cost, notify the Employer with a copy to the Engineer of such reduction in cost.”</p>
<p>Sub-Clause 13.8 Adjustment for Changes in Cost</p>	<p>Delete Paragraph 3 of this Sub-Clause and Substitute with the following:</p> <p>“The adjustment to be applied to the amount otherwise payable to the Contractor, as valued in accordance with the appropriate Schedule and certified in Payment Certificates, shall be determined from formulae for each of the currencies in</p>

which the Contract Price is payable. No adjustment is to be applied to work valued on the basis of Cost at current prices.

(A) For Electrical Works (Cost Centre 2.1) & related Sub-Cost Centres:

The formula for adjustment for changes in cost shall be as follows:

$$P_n = a + b(L_n/L_o) + c(C_n/C_o) + d(S_n/S_o) + e(K_n/K_o) + f(W_n/W_o) + g(E_n/E_o) + h(T_n/T_o) + i(F_n/F_o)$$

and

(B) For Signalling Works (Cost Centre 2.2) & related Sub-Cost Centres, Telecommunication Works (Cost Centre 2.3):

The formula for adjustment for changes in cost shall be as follows:

$$P_n = a + b(L_n/L_o) + i(F_n/F_o) + j(M_n/M_o)$$

where:

"P_n" is the adjustment multiplier to be applied to the contract amount paid against cost center / stage as per Price Schedule in the relevant currency for the completed stage of work;

"a" is a fixed coefficient, representing the **non-adjustable portion** for various cost center as per price schedule;

"b" is a fixed coefficient, representing the adjustable portion for **Labour** component for various cost center as per price schedule;

"c" is a fixed coefficient, representing the adjustable portion for **Cement & Lime** component for various cost center as per price schedule;

"d" is a fixed coefficient, representing the adjustable portion for **Steel (Long)** component for various cost center as per price schedule;

"e" is a fixed coefficient, representing the adjustable portion for **Copper** component for various cost center as per price schedule;

"f" is a fixed coefficient, representing the adjustable portion for **Electrical Accessories, Wires and Cables** for various cost center as per price schedule;

"g" is a fixed coefficient, representing the adjustable portion for **Electrical Machinery, Equipment & Batteries** for

	<p>relevant cost center as per price schedule;</p> <p>“h” is a fixed coefficient, representing the adjustable portion for Communication Equipment for relevant cost center as per price schedule; and</p> <p>“i” is a fixed coefficient, representing the adjustable portion for Fuel & Power for relevant cost center as per price schedule.</p> <p>“j” is the fixed coefficient, representing the adjustable portion for Materials for relevant cost centre as per price schedule.</p> <p>Values of a, b, c, d, e, f, g, h, i and j for various cost centres are detailed in Annexure I of the Appendix to Tender.</p> <p>"Ln", "Cn", "Sn", "Kn", "Wn", "En", "Tn", "Mn" and "Fn" are the current cost indices or reference prices for period "n", expressed in the relevant currency of payment, each of which is applicable to the relevant tabulated cost element on the date 49 days prior to the last day of the period, (to which the particular Payment Certificate relates) as detailed in the Annexure I to Appendix to Tender.</p> <p>"Lo", "Co", "So", "Ko", "Wo", "Eo", "To", "Mo" and "Fo" are the base cost indices or reference prices, expressed in the relevant currency of payment, each of which is applicable to the relevant tabulated cost element on the Base Date, as detailed in the Annexure I to Appendix to Tender.”</p>
<p>Sub-Clause 14.1 Contract Price</p>	<p>Add the following after the last paragraph -</p> <p>“The Contract Price includes all duties, taxes, royalties, premiums for various insurances, licenses and fees that may be levied in accordance with the laws and regulations in force as on the Base Date on the Contractor's Equipment, Plant, Materials and supplies acquired for the purpose of the Contract and on the services performed under the Contract.</p> <p>Nothing in the Contract shall relieve the Contractor from its responsibility to pay any tax including any tax that may be levied in India on profits made by it in respect of the Contract.”</p>
<p>Sub – Clause 14.2 Advance Payment</p>	<p>Replace the words “Performance Security” with “Performance Security and ESHS Performance Security” in the 3rd Paragraph.</p>
<p>Sub 14.2 (a) Advance Payment</p>	<p>Delete Sub Clause 14.2 (a) and substitute with the following:</p>

	<p>“Deductions shall commence in the Payment Certificate in which the total of all certified interim payments (excluding the advance payment and deductions and repayments of retention) exceeds twenty five percent (25%) of the Accepted Contract amount less provisional Sums; and”</p>
<p>Sub-Clause 14.3 Application for Interim Payment Certificates</p>	<p>Delete first paragraph of this Sub-Clause and substitute with the following:</p> <p>“The Contractor shall submit a Statement in six paper copies and two digital copies (read Only CD/DVD) to the Engineer after the end of the period of payment stated in the Contract (if not stated, after the end of each month), in a form approved by the Engineer, showing in detail the amounts to which the Contractor considers himself to be entitled, together with supporting documents and shall include the relevant report on progress also in accordance with Sub-Clause 4.21 [<i>Progress Report</i>], in two paper copies & two digital copies (Read Only CD/DVD). All paper copies shall bear the original signatures of the Contractor If these are found in order then the Engineer shall forward and the same to the Employer, with Interim Payment Certificate, as per clause 14.6, for payment, otherwise return back all documents to the Contractor for rectification and resubmission. Responsibility of preferring the Statement and entering the details shall vest with the Contractor. It is his responsibility to ensure that under no circumstances the payment claimed is more than the amount equivalent of Work done for that stage. If it is discovered otherwise during the check by the Engineer or the Employer then a warning will be issued in the first instance and in the second instance amount equivalent to 10% of excess claimed shall be forfeited besides denying the extra claim.</p> <p>While submitting the Statement all supporting details like measurements, sketches, drawings, approvals, calculations etc. shall be submitted with the Statement so that payment can be substantiated by the Engineer as well as by the Employer.</p> <p>Even if no stage of work is completed during the month or Contractor does not choose to submit Statement, a ‘NIL’ Statement shall be submitted by him.”</p> <p>In the third line of paragraph 2 (a) delete the word “(g)” and substitute with “(h)”</p>

	<p>Add the following paragraph at the end of this Sub-Clause:</p> <p>“(h) any amount to be deducted for taxes/ cess in accordance with the applicable laws.”</p>
<p>Sub-Clause 14.4 Schedule of Payments</p>	<p>Delete this Sub-Clause and substitute with the following:</p> <p>“The Employer shall make interim payments to the Contractor as certified by the Engineer under Sub-Clause 14.6 on the basis of the estimated value of the Works executed as determined in accordance with the following procedure:</p> <ul style="list-style-type: none">(a) The Price Schedules 1, 2, 2.1, 2.1.1 to 2.1.8, 2.2, 2.2.1 to 2.2.7, 2.3 and 2.3.1 to 2.3.8 lay down the frame work for estimating the value of stages of work completed. The Price Schedules specify the Contract Price for the Works offered by the Contractor and accepted by the Employer, along with the estimated value of work of different cost centres. The description of items of work in the Schedules does not limit in any way the Contractor's obligations under the Contract to provide all the Works described in the Employer’s Requirements.(b) The entire Work has been divided into three (3) main cost centres [Electrical Works (Cost Centre 2.1), Signalling Works (Cost Centre 2.2) and Telecommunication Works (Cost Centre 2.3) along with their respective weightage percentages of the Contract Price in Schedule 2. Each of the cost centres has been broken into items of works with percentage weightage of the Contract Price to items of the works/stages as indicated in Schedules 2.1.1 to 2.1.8, 2.2.1 to 2.2.7 and 2.3.1 to 2.3.8.(c) The Bidder shall compute, and supply to the Engineer, the total quantities (in units as described in the Price Schedule-2 and under its) of various items of works and components on the basis of detailed design reviewed/approved by the Engineer.(d) The Contractor shall base its claim for interim payment for each stage for various items of the work on completion till the end of the month for which the payment is claimed, supported with documents and an up-dated programme in accordance with the

	<p>Employer’s Requirements.</p> <p>(e) The weightage/percentage assigned to cost centres will apply only to the Contract Price stated in the Contract Agreement. It shall not apply to any additions or subtractions to the Contract Price arising from the issue of any Variation Orders. Each Variation Order shall specify the manner of interim payments and completion of stages for it.</p> <p>(f) For items of uncharted utilities, extra payment over and above the Contract Price shall be made in accordance with variation proposals made on case to case basis as per provisions of Contract. Contractor shall make a detailed report / proposal for removal/ relocation of uncharted utilities as per procedure outlined in Part 2 “Employer’s Requirement, Section-VI, Volume-1, General Specification”</p>
<p>Sub-Clause 14.6 Issue of Interim Payment Certificates</p>	<p>Replace the words “Performance Security” with “Performance Security and ESHS Performance Security” in the 1st Paragraph.</p> <p>In the 1st Paragraph, 2nd line, ‘28’ is replaced with ‘15’.</p> <p>Add Paragraph (c) after Paragraph (b) as following:</p> <p>if the Contractor was, or is, failing to perform any ESHS obligations or work under the Contract, the value of this work or obligation, as determined by the Engineer, may be withheld until the work or obligation has been performed, and/or the cost of rectification or replacement, as determined by the Engineer, may be withheld until rectification or replacement has been completed. Failure to perform includes, but is not limited to the following:</p> <p>(i) failure to comply with any ESHS obligations or work described in the Works’ Requirements which may include: working outside site boundaries, excessive dust, failure to keep public roads in a safe usable condition, damage to offsite vegetation, pollution of water courses from oils or sedimentation, contamination of land e.g. from oils, human waste, damage to archeology or cultural heritage features, air pollution as a result of unauthorized and/or inefficient combustion;</p> <p>(ii) failure to regularly review Contractor’s – Environmental and Social Management Plan (C-</p>

	<p>ESMP) and/or update it in a timely manner to address emerging ESHS issues, or anticipated risks or impacts;</p> <p>(iii) failure to implement the C-ESMP;</p> <p>(iv) failing to have appropriate consents/permits prior to undertaking Works or related activities;</p> <p>(v) failure to submit ESHS report/s (as described in Appendix 8), or failure to submit such reports in a timely manner;</p> <p>(vi) failure to implement remediation as instructed by the Engineer within the specified timeframe (e.g. remediation addressing non-compliance/s).</p>
<p>Sub-Clause 14.7 Payments</p>	<p>In the Sub-Clause 14.7 (a), Replace the words “Performance Security” with “Performance Security and ESHS Performance Security”</p> <p>In the Sub-Clause 14.7 (b), 1st line, ‘56’ is replaced with ‘30’.</p> <p>Delete the last paragraph of Sub-Clause 14.7 and substitute with the following:</p> <p>“Payment of the amount due in each currency shall be made in to the bank account of the Contractor (Sole/JV/JVA) or its individually authorised member(s), nominated by the Contractor in the payment country (for this currency) specified in the Contract. However, in respect of foreign currency payments, copies of supporting documents evidencing the import of goods /services shall be submitted by the Contractor.”</p>
<p>Sub-Clause 14.9 Payment of Retention Money</p>	<p>Delete first para of Sub-Clause 14.9 and substitute with the following:</p> <p>“A retention amounting to 10 (ten) per cent of the value of the work done shall be deducted by the Engineer in the first and following Interim Payment Certificates, until the amount so retained reaches a limit of retention money of 5 (five) percent of the Contract Price.</p> <p>The Contractor may replace the Retention Money deducted from Interim Payment Certificates on quarterly basis with an unconditional bank guarantee from the Bank of equivalent amount for the respective currency portions. The Bank Guarantees shall be valid for the period up to the end of the</p>

	Defect Notification Period.”
Sub-Clause 14.12 Discharge	Replace the words “Performance Security” with “Performance Security and ESHS Performance Security”
Sub-Clause 15.2 Termination by Employer	<p>Replace the words “Performance Security” with “Performance Security and ESHS Performance Security” in Sub-Clause (a)</p> <p>Delete the words “the whole of” in Sub-Clause (d) and Substitute with the following words</p> <p>“more than the percentage specified in Sub-Clause 4.4”</p>
Sub-Clause 15.3 Valuation at Date of Termination	<p>Delete the last line of this Sub-clause “work executed Contract” and substitute with the following:</p> <p>“Work completed up to any defined stage of payment in accordance with the Contract. Extent of damages to the Employer due to termination under sub-clause 15.2 has been fixed as (1) Forfeiture of Performance Security and ESHS Performance Security as defined in Sub – Clause 4.2 of PCC (2) Forfeiture of Retention money (3) five per cent (5%) of the cost of the balance work at the date of termination. The Parties hereby agree that the rate of these damages agreed in this is a reasonable pre-determined amount, and that these damages are not by way of penalty.”</p>
Sub-Clause 15.4 Payment after Termination	<p>Delete the Sub-Clause 15.4 and substitute with the following:</p> <p>“After a notice of termination under Sub-Clause 15.2 [<i>Termination by Employer</i>] has taken effect, the Employer may:</p> <ul style="list-style-type: none"> (a) proceed in accordance with Sub-Clause 2.5 [<i>Employer's Claims</i>]; (b) withhold further payments to the Contractor until the actions in accordance with the following sub-paragraphs (c), and (d) are completed; (c) encash and forfeit the whole of the amounts of Performance Security ESHS Performance Security as defined in Sub – Clause 4.2 of PCC and Retention Money and take possession of Plant and Materials delivered to Site, for which payment has been made by the Employer; (d) encash and appropriate the bank guarantee for the

	<p>Advance Payment to recover the outstanding amount, if any, of the Advance Payment; and</p> <p>(e) pay to the Contractor any sums due under Sub-clause 15.3 [Valuation at Termination], after the full amounts of the Performance Security, ESHS Performance Security and Retention Money and five per cent (5%) of the cost of the balance work (as per clause 15.3) and any other amount due from the Contractor have been received by the Employer. Any outstanding amounts against the Contractor shall immediately become due and payable by the Contractor to the Employer.”</p>
Sub – Clause 15.5 Employer’s Entitlement to Termination	Replace the words “Performance Security” with “Performance Security and ESHS Performance Security”
Sub-Clause 16.2 Termination by the Contractor	<p>Delete the Sub-Clause 16.2 (d)</p> <p>Delete the following words from 16.2 (e)</p> <p>“ or Sub-clause 1.7 [Assignment]”</p>
Sub-Clause 16.4 Payment on Termination	Replace the words “Performance Security” with “Performance Security and ESHS Performance Security” in Sub – Paragraph (a)
Sub-Clause 17.3 Employer’s Risks	Sub-paragraph (h) - Delete
Sub-Clause 18.1 General Requirement of Insurance	<p>Delete Sub-paragraph 6 (b) and replace with the following</p> <p>“ (b) copies of the policies for the insurances described in</p> <ul style="list-style-type: none"> (i) Sub-Clause 18.2 [Insurance for Works and Contractor’s Equipment], (ii) Sub-Clause 18.3 [Insurance against Injury to Person and Damage to Property], and (iii) Sub-Clause 18.5 [Professional Indemnity Insurance]”
Sub-Clause 18.2 Insurance of Works and Contractor’s Equipment	Sub-paragraph 4 (d) Delete the words “(c), (g) and (h)”, and substitute with the words “(c) and (g)”.
Sub-Clause 18.3 Insurance Against Injury to Persons and Damage to Property	<p>Add the following at the end of this Sub-Clause:</p> <p>“The insurance policy shall include a cross liability clause such that the insurance shall apply to the Employer, the Contractor and his Subcontractors (wherever applicable) as</p>

	<p>separately insured.</p> <p>The Employer shall not be liable for or in respect of any damages or compensation payable to any workman or other person in the employment of the Contractor or of any of his Sub- Contractor(s) (wherever applicable), other than death or injury resulting from any act or default of the Employer, his agents or employees. The Contractor shall indemnify and keep indemnified the Employer against all such damages and compensation, other than those for which the Employer is liable as aforesaid, and against all claims, proceedings, damages, costs, charges, and expenses whatsoever in respect thereof or in relation thereto.”</p>
<p>Sub- Clause 18.4 Insurance for Contractor's Personnel</p>	<p>Add the following at the end of this Sub-Clause:</p> <p>“The Employer shall not be liable for or in respect of any damages or compensation payable to any workman or other person in the employment of the Contractor or any</p> <p>Sub- Contractor (wherever applicable), other than death or injury resulting from any act or default of the Employer, his agents or employees. The Contractor shall indemnify and keep indemnified the Employer against all such damages and compensation, other than those for which the Employer is liable as aforesaid, and against all claims, proceedings, damages, costs, charges, and expenses whatsoever in respect thereof or in relation thereto.”</p>
<p>Sub-Clause 18.5 Professional Indemnity Insurance</p>	<p>Add the following new Sub-Clause:</p> <p>“The Contractor shall obtain the professional indemnity insurance, to cover the risk of professional negligence in the design of the Works carried by him, for the amount(s) stated in the Appendix to Tender and the insurance shall be maintained in full force and effect from the Commencement Date of the Works until 03 (three) years after the expiry of the Defects Notification /Extended Defects Notification Period. The insurance policy is required to indemnify the Employer as joint insured and the cover shall apply separately to each insured as though a separate policy had been issued for each of the joint insured.</p> <p>The Engineer will not certify any Payment Certificate until the Contractor has provided evidence of this insurance and its period of effectiveness.”</p>
<p>Sub Clause 20.6</p>	<p>Delete Sub-Clause 20.6 and substitute with the following:</p>

Arbitration

“Any dispute not settled amicably and in respect of which the DAB’s decision (if any) has not become final and binding shall be finally settled by arbitration. Unless otherwise agreed by both parties, arbitration shall be conducted as follows:

- (a) For contract with foreign contractors
 - (i) International arbitration in accordance with the rules of arbitration of the International Chamber of Commerce.
 - (ii) The seat of arbitration shall be Singapore/Dubai.
 - (iii) The number of Arbitrators shall be three (3) and language of communication will be English.
- (b) For contract with domestic contractors (For the purpose of this sub-clause, the term “Domestic Contractor” means a Contractor who is registered in India and is juridical person created under Indian Law as well as a joint venture between an Indian partner and a foreign partner where Indian partner is authorized representative of the JV or Lead Member).
 - (i) In accordance with rules of Arbitration of the International Centre for Alternative Dispute Resolution, New Delhi or such other rule as may be mutually agreed by the parties and shall be subject to the provision Indian Arbitration and Conciliation Act, 1996
 - (ii) The seat of arbitration shall be New Delhi.
 - (iii) The number of Arbitrators shall be three (3) and language of communication will be English.

The arbitrator(s) shall have full power to open up, review and revise any certificate, determination, instruction, opinion or valuation of the Engineer, and any decision of the DAB, relevant to the dispute. Nothing shall disqualify the Engineer from being called as a witness and giving evidence before the arbitrator(s) on any matter whatsoever relevant to the dispute.

Neither Party shall be limited in the proceedings before the arbitrator(s) to the evidence nor in arguments previously put before the DAB to obtain its decision, or to the reasons for dissatisfaction given in its notice of dissatisfaction. Any decision of the DAB shall be admissible in evidence in the arbitration.

Arbitration may be commenced prior to or after completion

	of the works. The obligations of the Parties, the Engineer and the DAB shall not be altered by reason of any arbitration being conducted during the progress of the Works.”
--	---

APPENDIX TO TENDER

Item	GC Sub- Clause	Data
Employer	1.1.2.2 & 1.3 (b)	Dedicated Freight Corridor Corporation of India Limited, 5 th Floor Pragati Maidan, Metro Station Building Complex, New Delhi, India – 110001 Authorised Representative and its communication address: <i>[To be inserted at the time of signing the Contract]</i>
Contractor	1.1.2.3 & 1.3 (b)	<i>[To be inserted at the time of signing the Contract]</i>
Engineer	1.1.2.4 & 1.3 (b)	<i>[To be inserted at the time of signing the Contract]</i>
Time for Completion	1.1.3.3	The Contractor shall complete the whole of the Works within 640 (Six Hundred Forty) days from the Commencement Date and each of the Milestones shall be achieved as per Sub-clause 8.2 of the Particular Conditions of Contract.
Defects Notification Period	1.1.3.7	2 (Two) years
Electronic Communications	1.3 (a)	In case of communication is through fax or e-mails, it should be confirmed through hard copy (paper) within 48 hours of transmission of fax or email. In case of delayed confirmation, the date and time of confirmation shall be deemed to be the date and time of hard copy (paper) communication delivered.
Governing Law	1.4	Republic of India
Ruling Language	1.4	English
Bank	1.15	The International Bank for Reconstruction and Development (IBRD) [World Bank]
Right of Access to the Site	2.1	The Employer / Engineer shall give Right to Access to Site to the Contractor, subject to the Contractor providing Performance Security & ESHS Performance Security in terms of Sub Clause 4.2 of General Conditions of Contract, in

Item	GC Sub- Clause	Data	
		the following manner: Possession of the site will be handed over to the Contractor as per the Work Plan approved by the Engineer for the execution of work of CP-105 or as per the Access Schedule for “Formation and Track of CP-302” appended in Part-4 Reference Documents, whichever is later.	
Security			
Amount of Performance Security	4.2	5 (Five) per cent of the Accepted Contract Amount, in local currency.	
Amount of Environmental, Social, Health and Safety (ESHS) Performance Security	4.2	1 (One) per cent of the Accepted Contract Amount, in local currency.	
General Design Obligations	5.1	56 Days	
Normal working hours	6.5	(Eight) 8 working hours shift in a day and total 48 (Forty eight) working hours in a week.	
Amount of Delay Damages	8.7 & 14.15 (b)	Milestone	Amount of Delay Damages
		For Milestone-1	INR 50,000/- (Rupees Fifty Thousand) per day
		For Milestone-2	INR 1,00,000/- (Rupees One Lakh) per day
		For Milestone-3	INR 2,00,000/- (Rupees Two Lakh) per day
		For Milestone-4	INR 3,00,000/- (Rupees Three Lakh) per day
Limit of Delay Damages for the whole of the Works	8.7	5 (Five) per cent of the Accepted Contract Amount in Local currency.	
Provisional Sum	13.5	No Provisional Sum is payable under this Contract.	
Price Adjustment	13.8	As detailed in Annexure I below.	
Advance Payment	14.2	Mobilization Advance	

Item	GC Sub- Clause	Data
		<p>The Employer shall pay, on written request from the Contractor, an interest free Mobilization Advance up to (Ten) 10 per cent of the Contract Price. The Mobilization Advance shall be released in two instalments as under:</p> <p>(a) Up to (Five) 5 per cent: On Submission of Performance Security and commencement of mobilization process; and</p> <p>(b) Up to (Five) 5 per cent: On Submission of the Inception Report and details of utilisation of initial Mobilization Advance of 5% to the satisfaction of Engineer.</p> <p>The Advance Payment will be released on submission of unconditional Bank Guarantee for an amount equivalent to the component of the advance payment requested by the Contractor.</p> <p>Such Bank Guarantees can be split in to a maximum of 5 (Five) Bank Guarantees for each of 5% mobilisation advance (at the option of the Contractor) to be released on repayments. All such Bank Guarantee(s) shall remain effective until the advance payment has been repaid pursuant to the provisions of Sub-Clause 14.2 of the Conditions of Contract, but the amount thereof shall be progressively reduced by the amount repaid by the Contractor as indicated in Interim Payment Certificates issued in accordance with this Clause.</p>
Percentage of Retention	14.3 (c)	10 (Ten) per cent
Limit of Retention Money	14.3 (c)	5 (Five) per cent of the Contract Price,
Plant and Materials for payment when delivered to Site	14.5 (c) (i)	For all the Goods / Material for which payment event/stage on Supply/Delivery has been specified in the Price Schedules
Delayed Payment	14.8	<p>The financing charges shall be calculated</p> <p>(i) at an annual rate of LIBOR rate +2% for foreign currency; and</p> <p>(ii) 8% per annum (fixed) for Indian currency</p>

Item	GC Sub- Clause	Data		
Currencies of Payment ¹	14.15	Currencies unit	Percentage Payable in the Currency	Rate of exchange: number of Local per unit of Foreign
		Local: (INR)		1.000
		Foreign: [name]		
		[name]		
		[name]		
Note: the above table is to be filled before the signing of the Contract Agreement.				
Evidence of Insurance	18.1 , 18.5	Before Commencement Date of Works		
Relevant Policies	18.1(b)	Within 84 days of Commencement Date of Works		
Minimum amount of deductibles for insurance of the Employer's Risk	18.2 (d)	Zero Deductible		
Minimum amount of third party Insurance	18.3	Rs 100,000,000 (One hundred million) for any one occurrence.		
Professional Indemnity Insurance	18.5	Rs 250,000,000 (Two hundred fifty million)		
Appointment of Dispute Adjudication Board	20.2	The DAB shall comprise of three members		
Failure to Agree Dispute Adjudication Board	20.3	Appointing Entity: Chairman of the Institution of Engineers (India) Delhi State Center		

¹ To be filled at the time of signing the Contract

Annexure – I

Price Adjustment

(Sub-Clause 13.8)

1. Values of a, b, c, d, e, f, g, h, I and j for various Cost centres shall be as below:

(A) For Electrical Works (Cost Centre 2.1) & related Sub-Cost Centres:

COST CENTER		OHE Works	Traction Power Supply and E&M	SCADA
PRICE SCHEDULE		2.1.2	2.1.3, 2.1.4, 2.1.6, & 2.1.7	2.1.5
COEFFICIENTS				
Fix Component	a	0.20	0.20	0.20
Labour	b	0.10	0.07	0.05
Cement & Lime	c	0.05	0.03	-
Steel (Long)	d	0.30	0.05	-
Copper	e	0.25	-	-
Electrical Accessories, Wires and Cables	f	0.05	0.03	-
Electrical Machinery, Equipment & Batteries	g	-	0.60	0.05
Communication Equipment	h	-	-	0.68
Fuel & Power	i	0.05	0.02	0.02
TOTAL		1.00	1.00	1.00

(B) For Signalling Works (Cost Centre 2.2) & related Sub-Cost Centres and Telecommunication Works (Cost Centre 2.3) & related Sub-Cost Centres:

COST CENTER		For Signalling and Telecommunication Works
PRICE SCHEDULE		2.2 and 2.3
COEFFICIENTS		
Fix Component	a	0.15
Labour	b	0.30
Fuel & Power	i	0.15
Materials	j	0.40
TOTAL		

2. Values for Current Cost indices ("Ln", "Cn", "Sn", "Kn", "Wn", "En", "Tn", "Mn" and "Fn") and Base Cost indices ("Lo", "Co", "So", "Ko", "Wo", "Eo", "To", "Mo" and "Fo") shall be taken as follows:

Item	Indices	If procured from Employer's Country	If procured from outside Employer's Country
Labour	Ln or Lo	'Consumer Price Index for Industrial Workers' published by Labour Bureau (Government of India)	Index provided by the Bidder in Price Schedule 1 (Part 1: Section IV-Bidding Forms)
Cement & Lime	Cn or Co	'Wholesale price index for Cement & Lime' (Code 13090 30000) published by Ministry of Commerce and Industry (Government of India)	
Steel (Long)	Sn or So	'Wholesale price index for Steel (Long)' (Code-1310010200) published by Ministry of Commerce and Industry (Government of India)	
Copper	Kn or Ko	'Rates for Copper ' published by London Metal Exchange)	
Electrical Accessories, Wires and Cables	Wn or Wo	'Wholesale price index for Electrical Accessories, Wires and Cables etc. (Code-1311080000)' published by Ministry of Commerce and Industry (Government of India)	
Electrical Machinery, Equipment & Batteries	En or Eo	'Wholesale price index for Electrical Machinery, Equipment & Batteries (Code-1311070000)' published by Ministry of Commerce and Industry (Government of India)	
Communication Equipment	Tn or To	'Wholesale price index for Communication Equipment (Code-1311120000)' published by Ministry of Commerce and Industry (Government of India)	
Fuel & Power	Fn or Fo	'Wholesale price index for Fuel & Power (Code-1200000000)' published by Ministry of Commerce and Industry (Government of India)	
Materials	Mn or Mo	Wholesale Price Index for All Commodities (Code- 1000000000)' published by Ministry of Commerce and Industry (Government of India)	

Note: Currently the indices published by Ministry of Commerce and Industry (Government of India) are available at web-site <http://www.eaindustry.nic.in>.

3. Price Adjustment for each cost centre shall be made separately as set in the following table:

Price Schedule No.	Heading of Price Schedule	Price adjustment pursuant to Sub-Clause 13.8 of Conditions of Contract
2.1.1	Surveys, Investigations, Studies, Design & Documents, O & M Manuals and As Built Drawings, Training of Staff	Price Adjustment shall not be applicable
2.1.2	OHE Works	Price Adjustment shall be applicable
2.1.3	Traction Sub Station (TSS) Works	Price Adjustment shall be applicable
2.1.4	Sub-Sectioning Post (SSP) Works	Price Adjustment shall be applicable
2.1.5	SCADA Works	Price Adjustment shall be applicable
2.1.6	E&M Works	Price Adjustment shall be applicable
2.1.7	Supply of Contract Spares and Special Tools & Instruments	Price Adjustment shall be applicable
2.1.8	Integrated Testing, Commissioning and Final Taking over of Works	Price Adjustment shall not be applicable
2.2.1	Design & Documentation	Price Adjustment shall not be applicable
2.2.2	Signalling Works at the Junction Station	Price Adjustment shall be applicable
2.2.3	Signalling Works in Automatic Block Sections	Price Adjustment shall be applicable
2.2.4	Train Management System (TMS) and Service and Diagnostic System (S&D)	Price Adjustment shall be applicable
2.2.5	Supply of Contract Spares and Special Tools & Test Equipment	Price Adjustment shall be applicable
2.2.6	Integrated Testing & Commissioning and Final Taking Over	Price Adjustment shall not be applicable
2.2.7	Training	Price Adjustment shall not be applicable
2.3.1	Design and Documentation	Price Adjustment shall not be applicable
2.3.2	Telecom Works at 1 Junction station	Price Adjustment shall be applicable
2.3.3	Telecom works at Operational Control Centre (OCC)	Price Adjustment shall be applicable

Price Schedule No.	Heading of Price Schedule	Price adjustment pursuant to Sub-Clause 13.8 of Conditions of Contract
2.3.4	Telecom works in Automatic Block Sections	Price Adjustment shall be applicable
2.3.5	Integrated Testing & Commissioning and Final Taking-Over	Price Adjustment shall not be applicable
2.3.6	Contract Spares	Price Adjustment shall be applicable
2.3.7	Special Tools & Test Equipment	Price Adjustment shall be applicable
2.3.8	Training	Price Adjustment shall not be applicable

4. Price adjustment shall be applied on completion of the specified stage of the item of work tabulated in each Price Schedule.

Section IX. - Contract Forms

Table of Forms

S. No.	Sub-Clause	Description	Page
01	1.1.1.3	Letter of Acceptance	41
02	1.6	Form of Contract Agreement	42
03	4.2	Form of Performance Security (Demand Guarantee)	45
04	4.2	Form of Environmental, Social, Health and Safety (ESHS) Performance Security (ESHS Demand Guarantee)	47
05	14.2	Form of Advance Payment Security (Demand Guarantee)	49
06	14.9	Form of Retention Money Security (Demand Guarantee)	51

LETTER OF ACCEPTANCE

(Sub-Clause 1.1.1.3)

[On the letterhead paper of the Employer]

No.

Dated.....

To: *[name and address of the Contractor]*

This is to notify you that your Bid dated *[date]* for execution of the *[name of the Contract and identification number, as given in the Contract Data]* for the Accepted Contract Amount *[amount in numbers and words] [name of currency/currencies]*, as corrected and modified in accordance with the Instructions to Bidders, is hereby accepted by the Competent Authority

You are requested to furnish the Performance Security and an Environmental, Social, Health and Safety Performance Security within 28 days in accordance with the Conditions of Contract, using for that purpose Performance Security Form and the ESHS Performance Security Form, included in Section IX, Contract Forms, of the Bidding Documents.

Authorized Signature: _____

Name and Title of Signatory: _____

Name of Agency: Dedicated Freight Corridor Corporation of India Ltd

Note: All italicized text (including footnotes) is for use in preparing this form and shall be deleted from the final product.

Form of

Contract Agreement

THIS AGREEMENT made the _____ day of _____, _____,

BETWEEN

(1) Dedicated Freight Corridor Corporation of India Limited, incorporated under the laws of India and having its principal place of business at 5th Floor, Pragati Maidan Metro Station Building Complex, New Delhi, India – 110001 (hereinafter called ‘**the Employer**’) of the first part

AND

(2) M/S _____
a company/corporation/JV incorporated under the laws of _____ having its principal place of business at _____ (hereinafter called “**the Contractor**”) of the other part.

WHEREAS the Employer desires that the Works known as “Design, Supply, Construction, Installation, Testing and Commissioning of 2x25kV AC Electrification, Signalling & Telecommunication, E&M and Associated Works on Design-Build Lump Sum Basis for Dadri-Khurja Section (approximately 47 Route Km of Double Line) of Eastern Dedicated Freight Corridor “**Contract Package No. 105**” should be executed by the Contractor, and has accepted a Bid submitted by the Contractor for the execution and completion of these Works and the remedying of any defects therein,

The Employer and the Contractor agree as follows:

1. In this Agreement words and expressions shall have the same meanings as are respectively assigned to them in the Contract documents referred to.
2. The following documents shall be deemed to form and be read and construed as part of this Agreement.
 - (i) The Letter of Acceptance dated _____;
 - (ii) Certificate regarding Authenticity of Document;
 - (iii) Minutes of meeting of pre-award clarifications / negotiations after opening of the Second Stage Bid, if any;
 - (iv) Addenda to Bidding Documents No. _____ dated _____, (*insert the addenda numbers and date*) if any;
 - (v) Letter of Bid-(Two Stage Bidding, Second Stage Bidding) dated _____;
 - (vi) Appendix to Bid (Percentage Breakup of Lump Sum Bid Price for local & foreign currencies;

- (vii) Price Schedules submitted by the Contractor;
 - (viii) Letter of Bid (First Stage Bidding) dated _____;
 - (ix) Appendix to Tender;
 - (x) Particular Conditions;
 - (xi) General Conditions;
 - (xii) Memorandum titled ‘Changes Required Pursuant to First Stage Evaluation’;
 - (xiii) Employer’s Requirements;
 - (xiv) Contractor’s Updated Technical Proposal;
 - (xv) Part 4 of Bidding document; and
 - (xvi) Any other documents forming part of the Employer’s requirements and Bidding documents including, but not limited to:
 - i. the ESHS Management Strategies and Implementation Plans; and
 - ii. Code of Conduct (ESHS).
3. In consideration of the payments to be made by the Employer to the Contractor as indicated in this Agreement, the Contractor hereby covenants with the Employer to execute the Works and to remedy defects therein in conformity in all respects with the provisions of the Contract.
4. The Employer hereby covenants to pay the Contractor in consideration of the execution and completion of the Works and the remedying of defects therein, the Contract Price or such other sum as may become payable under the provisions of the Contract at the times and in the manner prescribed by the Contract.
5. **The Commencement Date of the Works is** _____ *[insert here date of commencement]* as notified by the Engineer vide his letter no. _____ dated _____ and **the Completion date** for Whole of the Works pursuant to Sub-Clause 8.2 of the Conditions of Contract is _____ *[insert date of Completion]*.
6. **The address of the Employer for notice purposes, pursuant to GC 1.3 is:**

Authorised Representative

[To be inserted at the time of signing the Contract]

with a copy endorsed to the *[To be inserted at the time of signing the Contract]*

7. The address of the Contractor for notice purposes, pursuant to GC 1.3 is:

(insert address of the Contractor).

8. The address of the Engineer for notice purposes, pursuant to GC 1.3 is:

(insert address of the Engineer).

IN WITNESS whereof the parties hereto have caused this Agreement to be executed in accordance with the laws of Republic of India on the day, month and year indicated above.

Contractor

Employer

Signature of the Authorised Person

Signature of the Authorised Person

Name:

Name:

Designation:

Designation:

For and on behalf of M/s _____

For and on behalf of Dedicated Freight
Corridor Corporation of India Ltd

Witness-1:

Witness-1:

Signature

Signature

Name:

Name:

Designation:

Designation:

Address:

Address:

Witness-2:

Witness-2:

Signature

Signature

Name:

Name:

Designation:

Designation:

Address:

Address:

Performance Security (Demand Guarantee)

[Guarantor letterhead or SWIFT identifier code]

Beneficiary: *[insert name and Address of Employer]*

Date: *_ [Insert date of issue]*

PERFORMANCE GUARANTEE No.: *[Insert guarantee reference number]*

Guarantor: *[Insert name and address of place of issue, unless indicated in the letterhead]*

We have been informed that *_ [insert name of Contractor, which in the case of a joint venture shall be the name of the joint venture]* (hereinafter called "the Applicant") has entered into Contract No. *[insert reference number of the contract]* dated *[insert date]* with the Beneficiary, for the execution of *_ [insert name of contract and brief description of Works]* (hereinafter called "the Contract").

Furthermore, we understand that, according to the conditions of the Contract, a performance guarantee is required.

At the request of the Applicant, we as Guarantor, hereby irrevocably undertake to pay the Beneficiary any sum or sums not exceeding in total an amount of *[insert amount in figures]()[insert amount in words]*,¹ such sum being payable in the types and proportions of currencies in which the Contract Price is payable, upon receipt by us of the Beneficiary's complying demand supported by the Beneficiary's statement, whether in the demand itself or in a separate signed document accompanying or identifying the demand, stating that the Applicant is in breach of its obligation(s) under the Contract, without the Beneficiary needing to prove or to show grounds for your demand or the sum specified therein.

This guarantee shall expire, no later than the Day of, 2...², and any demand for payment under it must be received by us at this office indicated above on or before that date.

¹ *The Guarantor shall insert an amount representing the percentage of the Accepted Contract Amount specified in the Letter of Acceptance, less provisional sums, if any, and denominated either in the currency(cies) of the Contract or a freely convertible currency acceptable to the Beneficiary.*

² *Insert the date twenty-eight days after the expected completion date as described in GC Clause 11.9. The Employer should note that in the event of an extension of this date for completion of the Contract, the Employer would need to request an extension of this guarantee from the Guarantor. Such request must be in writing and must be made prior to the expiration date established in the guarantee. In preparing this guarantee, the Employer might consider adding the following text to the form, at the end of the penultimate paragraph: "The Guarantor agrees to a one-time extension of this guarantee for a period*

This guarantee is subject to the Uniform Rules for Demand Guarantees (URDG) 2010 Revision, ICC Publication No. 758, except that the supporting statement under Article 15(a) is hereby excluded.

[signature(s)]

Note: All italicized text (including footnotes) is for use in preparing this form and shall be deleted from the final product.

not to exceed [six months][one year], in response to the Beneficiary's written request for such extension, such request to be presented to the Guarantor before the expiry of the guarantee."

Environmental, Social, Health and Safety (ESHS) Performance Security

ESHS Demand Guarantee

[Guarantor letterhead or SWIFT identifier code]

Beneficiary: *[insert name and Address of Employer]*

Date: *_ [Insert date of issue]*

ESHS PERFORMANCE GUARANTEE No.: *[Insert guarantee reference number]*

Guarantor: *[Insert name and address of place of issue, unless indicated in the letterhead]*

We have been informed that _____ (hereinafter called "the Applicant") has entered into Contract No. _____ dated _____ with the Beneficiary, for the execution of _____ (hereinafter called "the Contract").

Furthermore, we understand that, according to the conditions of the Contract, a performance guarantee is required.

At the request of the Applicant, we as Guarantor, hereby irrevocably undertake to pay the Beneficiary any sum or sums not exceeding in total an amount of _____ (),¹ such sum being payable in the types and proportions of currencies in which the Contract Price is payable, upon receipt by us of the Beneficiary's complying demand supported by the Beneficiary's statement, whether in the demand itself or in a separate signed document accompanying or identifying the demand, stating that the Applicant is in breach of its Environmental, Social, Health and/or Safety (ESHS) obligation(s) under the Contract, without the Beneficiary needing to prove or to show grounds for your demand or the sum specified therein.

This guarantee shall expire, no later than the Day of, 2...², and any demand for payment under it must be received by us at this office indicated above on or before that date. This guarantee is subject to the Uniform Rules for Demand Guarantees (URDG) 2010 Revision, ICC Publication No. 758, except that the supporting statement under Article 15(a) is hereby excluded.

¹ The Guarantor shall insert an amount representing the percentage of the Accepted Contract Amount specified in the Letter of Acceptance, less provisional sums, if any, and denominated either in the currency (cies) of the Contract or a freely convertible currency acceptable to the Beneficiary.

² Insert the date twenty-eight days after the expected completion date as described in GC Clause 11.9. The Employer should note that in the event of an extension of this date for completion of the Contract, the Employer would need to request an extension of this guarantee from the Guarantor. Such request must be in writing and must be made prior to the expiration date established in the guarantee. In preparing this guarantee, the Employer might consider adding the following text to the form, at the end of the penultimate paragraph: "The Guarantor agrees to a one-time extension of this guarantee for a period not to exceed [six months] [one year], in response to the Beneficiary's written request for such extension, such request to be presented to the Guarantor before the expiry of the guarantee."

[signature(s)]

Note: All italicized text (including footnotes) is for use in preparing this form and shall be deleted from the final product.

Advance Payment Security

Demand Guarantee

[Guarantor letterhead or SWIFT identifier code]

Beneficiary: *[Insert name and Address of Employer]*

Date: *[Insert date of issue]*

ADVANCE PAYMENT GUARANTEE No.: *[Insert guarantee reference number]*

Guarantor: *[Insert name and address of place of issue, unless indicated in the letterhead]*

We have been informed that *[insert name of Contractor, which in the case of a joint venture shall be the name of the joint venture]* (hereinafter called “the Applicant”) has entered into Contract No. *[insert reference number of the contract]* dated *[insert date]* with the Beneficiary, for the execution of *[insert name of contract and brief description of Works]* (hereinafter called “the Contract”).

Furthermore, we understand that, according to the conditions of the Contract, an advance payment in the sum *[insert amount in figures]* (*[insert amount in words]*) is to be made against an advance payment guarantee.

At the request of the Applicant, we as Guarantor, hereby irrevocably undertake to pay the Beneficiary any sum or sums not exceeding in total an amount of (*[insert amount in figures]*) (*[insert amount in words]*)¹ upon receipt by us of the Beneficiary’s complying demand supported by the Beneficiary’s statement, whether in the demand itself or in a separate signed document accompanying or identifying the demand, stating either that the Applicant:

(a) has used the advance payment for purposes other than the costs of mobilization in respect of the Works; or

(b) has failed to repay the advance payment in accordance with the Contract conditions, specifying the amount which the Applicant has failed to repay.

A demand under this guarantee may be presented as from the presentation to the Guarantor of a certificate from the Beneficiary’s bank stating that the advance payment referred to

¹ *The Guarantor shall insert an amount representing the amount of the advance payment and denominated either in the currency(ies) of the advance payment as specified in the Contract, or in a freely convertible currency acceptable to the Employer.*

above has been credited to the Applicant on its account number *[insert number]* at *[insert name and address of Applicant's bank]*..

The maximum amount of this guarantee shall be progressively reduced by the amount of the advance payment repaid by the Applicant as specified in copies of interim statements or payment certificates which shall be presented to us. This guarantee shall expire, at the latest, upon our receipt of a copy of the interim payment certificate indicating that ninety (90) percent of the Accepted Contract Amount, less provisional sums, has been certified for payment, or on the *[insert day]*day of *[insert month]*, 2*[insert year]*,² whichever is earlier. Consequently, any demand for payment under this guarantee must be received by us at this office on or before that date.

This guarantee is subject to the Uniform Rules for Demand Guarantees (URDG) 2010 Revision, ICC Publication No. 758, except that the supporting statement under Article 15(a) is hereby excluded.

[signature(s)]

Note: All italicized text (including footnotes) is for use in preparing this form and shall be deleted from the final product.

² *Insert the expected expiration date of the Time for Completion. The Employer should note that in the event of an extension of the time for completion of the Contract, the Employer would need to request an extension of this guarantee from the Guarantor. Such request must be in writing and must be made prior to the expiration date established in the guarantee. In preparing this guarantee, the Employer might consider adding the following text to the form, at the end of the penultimate paragraph: "The Guarantor agrees to a one-time extension of this guarantee for a period not to exceed [six months][one year], in response to the Beneficiary's written request for such extension, such request to be presented to the Guarantor before the expiry of the guarantee."*

Retention Money Security

Demand Guarantee

_____ *[Bank's Name, and Address of Issuing Branch or Office]*

Beneficiary: _____ *[Name and Address of Employer]*

Date: _____

RETENTION MONEY GUARANTEE No.: _____

We have been informed that *[name of Contractor]* (hereinafter called "the Contractor") has entered into Contract No. *[reference number of the contract]* dated *[date]* with you, for the execution of *[name of contract and brief description of Works]* (hereinafter called "the Contract").

Furthermore, we understand that, according to the conditions of the Contract, when the Taking-Over Certificate has been issued for the Works and the first half of the Retention Money has been certified for payment, payment of *[insert the second half of the Retention Money or if the amount guaranteed under the Performance Guarantee when the Taking-Over Certificate is issued is less than half of the Retention Money, the difference between half of the Retention Money and the amount guaranteed under the Performance Security and the ESHS Performance Security]* is to be made against a Retention Money guarantee.

At the request of the Contractor, we *[name of Bank]* hereby irrevocably undertake to pay you any sum or sums not exceeding in total an amount of (*[amount in figures]*)(*[amount in words]*)¹ upon receipt by us of your first demand in writing accompanied by a written statement stating that the Contractor is in breach of its obligation under the Contract because the Contractor used the advance payment for purposes other than the costs of mobilization in respect of the Works.

It is a condition for any claim and payment under this guarantee to be made that the payment of the second half of the Retention Money referred to above must have been received by the Contractor on its account number _____ at *[name and address of Bank]*.

This guarantee shall expire, at the latest, 21 days after the date when the Employer has received a copy of the Performance Certificate issued by the Engineer. Consequently, any demand for payment under this guarantee must be received by us at this office on or before that date.

¹ *The Guarantor shall insert an amount representing the amount of the second half of the Retention Money or if the amount guaranteed under the Performance Guarantee when the Taking-Over Certificate is issued is less than half of the Retention Money, the difference between half of the Retention Money and the amount guaranteed under the Performance Security and denominated either in the currency(ies) of the second half of the Retention Money as specified in the Contract, or in a freely convertible currency acceptable to the Employer.*

This guarantee is subject to the Uniform Rules for Demand Guarantees (URDG) 2010 Revision, ICC Publication No. 758, except that the supporting statement under Article 15(a) is hereby excluded.

[signature(s)]

Note: All italicized text (including footnotes) is for use in preparing this form and shall be deleted from the final product.