

OPERATING MANUAL



DEDICATED FREIGHT CORRIDOR CORPORATION OF INDIA LIMITED

A Govt. of India (Ministry of Railways) Enterprise

FEBRUARY 2018

PREFACE

1. This is the first issue of the Operating Manual of DFCCIL. This manual is meant to provide guidance to DFCCIL staff involved in train operation train operators. In the beginning the IR is expected to be the sole operator on DFCCIL.
2. In a manual of this kind it is not possible to foresee and provide instructions for every eventuality. An attempt has been made to visualize various situations that are likely to arise in day to day working and lay down instructions to meet them.
3. This manual does not supersede or alter in any way the Rules contained in General and Subsidiary Rules of DFCCIL or any other statutory publication.
4. This manual is solely for official use and is not for the information of public or for sale to public.

Index

Sr.No.	Chapter	Page No.
1	Introduction	4
2	DFCCIL Employee Responsibilities	9
3	DFCCIL Train Controller responsibilities	14
4	DFCCIL Train control system	19
5	DFCCIL Traction Power control system	27
6	DFCCIL Traction locomotive controller / Crew Controller	29
7	DFCCIL Wagon Control	30
8	Train Operator requirement on DFC network	31
9	Wayside Monitoring Devices	49
10	Rolling Stock operating on DFC Network	50
11	Train Diversions	51
12	Safe working Operations	52
13	Train Service Planning	53
14	Rolling Stock Outlines and Load Restrictions	55
15	Train Marshalling	61
16	Train Inspection	62
17	Train Documentation	63
18	Train Failures	65
19	Track Maintenance Machines	67
20	Interface Coordination Plan (ICP)	69
21	Coordination of Emergency Rescue Operations	71
22	Preferential schedule and rationalization	76
23	Station Working Rules	77
24	Temporary Working Order and Non Interlock working of stations	83
25	System of Interlocking	98
26	System of Communication	111

Appendices

Appendix	Description	Page No.
Appendix A	Model SWR	121
Appendix B	Normal period for which Station Operating Registers and Records are required to be preserved	130
Appendix C	Authorities used in train operation	131

1. Introduction

1.1 Overview

This version of the DFCCIL Operations Manual specifies operator access and operating requirements for the Dedicated Freight Corridor (DFC) network operated by the Dedicated Freight Corridor Corporation of India Limited (DFCCIL). It has been published by DFCCIL specifically for the use of DFCCIL employees and Train Operators requiring access to the DFC network, including Third Party Contractors that operate rail borne equipment or work trains.

It also contains important infrastructure and operational information about the DFC network. Information regarding rolling stock provided in this operations manual is limited to addressing the critical interfaces between rail traffic and the DFC infrastructure.

The terms and conditions upon which access is granted to the DFC network are specified in an Access Agreement negotiated between DFCCIL and the Operator.

1.2 Train Operator Requirements

The scope and contents of this Operations Manual for Operators is based on the premise that DFCCIL will normally operate all goods trains on the DFC network using operators' rolling stock. However, the procedures provided herein are applicable to any operator of trains and/or rail borne equipment that may require to access the DFC network.

Operators seeking access to the DFC shall develop and maintain documented and approved systems specific to the requirements of their operations and safety management system to ensure that they comply with the requirements of the DFC Operator documentation should include, but not be limited to:

- a) Rolling stock fleet capability and constraints;
- b) Rolling stock maintenance systems;
- c) Locomotive Pilot and guard (where applicable), safe working, route knowledge, train handling, training and competency;
- d) Environmental requirements;
- e) Occupational Health and Safety (OHS) requirements including policies relating to drug, alcohol and hours of employment, and
- f) Risk management.

1.3 Compliance

Where applicable, operators and third parties requiring access to the DFC network shall comply with the DFCCIL General Rules, Instructions, this Operations Manual, Station working rules and any other instruction that may be issued pertaining to the safe operation of rail traffic on the DFC.

1.4 DFCCIL Station Staff

Stations, junctions and terminals on the DFC are managed by a DFCCIL stationmaster (SM) and other employees reporting to the stationmaster. The DFCCIL SM and employees manage all rail activities within the station under the direction of the DFCCIL train controller.

Glossary

Above Rail	Rail functions for which a Rail Operator working a train on the DFCCIL is responsible.
Access Agreement	The contract that specifies the terms and conditions for access to the DFC network by a Rail operator
Adjoining Network	A Network that abuts the DFC network e.g. Indian Railways
Air Brake	A braking system activated by a change of air pressure
Approved means of communication	Any communication equipment or system which is capable of audio transmission between the train controller, and /or stations and /or Locomotive Pilot and is approved under special instructions,
ASM	Assistant Station Master
Attended Station	A station on double line or single line at which a Station Master, Assistant Station Master or qualified worker is located to perform duties including the operation of the signalling to side track a train allow another train to cross or pass.
Authorized officer	means the Director (OP & BD), DFCR, empowered to issue instructions or to do any other thing;
Automatic Air Brake	A braking system where the loss of air pressure (e.g brake pipe pressure) automatically results in an emergency brake application
Axle Counter	An electrical device which, when provided at two given points on the track, proves by counting axles in and counting axles out, whether the section of the line between the said two points is clear or occupied.
Bi-Directional Tracks	Single or Parallel lines on which the signalling will permit trains to travel in either direction.
Block working	Trains cannot collide with each other if they are not permitted to occupy the same section of track at the same time. Railway lines are divided into sections known as blocks. In normal circumstances, only one train is permitted in each block at a time.
Brake Holding Test	A test that proves the brakes on the rear three vehicles, and any other tested vehicles, will remain applied for a long enough period of time in the event of a breakaway, to allow the Locomotive Pilot to reach these vehicles and apply the hand brakes, in order to secure the train.
Brake Inspection	A test to ensure that all the brakes will apply and release in response to brake pipe pressure fall and rise, brake pipe piston travel does not exceed limits and brake force cause the brake shoes to be forced against the wheels and that all handbrakes are released.
Brake Pipe Continuity	A test to ensure that the brake pipe is continuous through the train
Brake Pipe Leakage Test	A test to determine whether there are excessive air leaks in the train that may interfere with the operation of the air brake system and confirm that only one brake valve controls the train.
Compensated Grade	The allowance for the friction in a curve on a grade expressed as an increased steepness of the grade.
Danger Zone	The zone within 2 meters of any live equipment in the 25KV AC traction system where there is danger to life or injury from shock, burn, fire or explosion, attendant upon transmission, transformation, conversion, distribution or use of electrical energy and in which no work is permitted when the equipment is live.

Dedicated Freight Corridor	All tracks, signals and other rail infrastructure operated and managed by the DFCCIL.
DFC	Dedicated Freight Corridor
Dedicated Freight Corridor Corporation of India Ltd	The rail organisation responsible for the management and operation of the DFC
DFCCIL	Dedicated Freight Corridor Corporation of India Limited
Disabled Train	A train with a failure such that it cannot complete its journey under its own power.
Distributed Power	An arrangement to synchronise powering of two or more locomotives distributed along the length of the train. The locomotives(s) located mid-train or at the rear is/are remote controlled from the leading locomotive through radio transmission
Draw Capacity	The strength of a vehicle (Couplers, draft gear, under frame etc) used to determine the load that can be hauled behind the vehicle.
Electrified Line	Track provided with Overhead equipment
Emergency Cock	A readily accessible, manually operated valve or tap, in a vehicle with an automatic air brake that exhaust the brake pipe to atmosphere causing an emergency brake application. Sometimes referred to as an emergency brake pipe tap.
End of Train Marker (EOTM)	A device fitted to the trailing end of the last vehicle of a train
EOTT	End of Train Telemetry
EP Brake	Electro- pneumatic brake
Full Train Inspection	A locomotive hauled train inspection that include loading and security checks, full mechanical inspection, brake pipe leakage test, air brake inspection and test, brake holding and pipe continuity test.
Goods Train	A train (other than a material train) intended solely or mainly for the carriage of animals or goods.
Hand brake	A mechanical device used to secure a rail vehicle against movement. Handbrake includes a spring parking brake.
He, Him, His	The term He, Him, His shall refer to both Males and Females performing the said duties. May also be referred to as Rail Servant or Qualified Worker.
ICP	Interface Coordination Plan
IR	Indian Railways
Light Locomotive	One or more locomotives operating while not attached to another vehicle.
Loading Outline	The maximum height and width to which rail vehicle can be loaded for a particular route, as prescribed in the operations Manual.
Locomotive Pilot	The Rail Servant/Qualified Worker in charge of driving a locomotive or other self-powered rail borne equipment.
LOCOTROL	Control of loco operations in long haul trains with multiple unit locomotives.
Marker	Lights that indicate the front or rear of the train
May	The term 'may' indicates the existence of an option
Modified Continuity test	A test to ensure the correct brake operation on the first three vehicles beyond the furthest amalgamation point when a locomotive or vehicles are attached to or detached from a train.
Multiple Unit Locomotive	Two or more locomotives marshalled together to provide the power to move itself or with other vehicles

Multiple Unit Train	A train consisting of two or more single unit trains coupled together and operated as one train
Network User	A Person/Company accessing the DFC network by reason by access agreement or maintenance agreement or other authority to be on the Network.
OCS	Officer in Charge of the Site
ODC	Over Dimensional Consignment
Operator	An organisation that manages, operates or maintains rail traffic on the DFC network pursuant to an Access Agreement
Operator Representative	A person authorized by an Operator's behalf
Overhead equipment	The electrical conductors over the tracks together with their associated fittings, insulators and other attachments, by mean of which they are suspended and secured in position for the purpose of electric traction.
OHE	Overhead Equipment.
OHE Recording car	A vehicle usually self-propelled, used for recording parameters of overhead equipment
ODC (Over Dimensional consignment)	A vehicle or load exceeding the loading outline for a particular section of track.
ODC train	A train with ODC rolling stock
Over-length train	A train exceeding the network infrastructure limits for train length.
Parallel line	A railway line that runs parallel and can either be operated by the same rail operator or an alternative rail operator.
Procedure	A set of instructions written specifically for use by that organization.
Programmed, Preventive, Maintenance (PPM)	Regular vehicle or train maintenance cycle based on a fixed time interval or distance travelled to ensure that vehicles remain fit for use on the DFC network for at least the duration of the PPM cycle.
Qualified Worker	A rail servant who possesses the necessary qualifications to perform specified tasks such as train driving, shunting, Station Master, and any other tasks pertaining to the operation of the railway.
Railway	Railways as defined under section 2 clause (31) of the Railways Act, 1989 and includes Government and non-government Railways.
Railways Act	Indian Railways Act, 1989
Railway Servant	Staff of the Government Railways, DFCCIL, and any other non-government railways, on whom any definite responsibility is entrusted by the relevant rules, procedures and other issued manuals and instructions. May also be referred to as the Qualified Worker.
Rail Operator	An operator responsible for rail infrastructure, train control, signalling, and above rail operations where applicable.
Rail-cum-Road Vehicle,	A specially designed vehicle, capable of travelling on both road and rails and is used for inspection and maintenance work. The vehicle will normally run on road and would run on rails only on the section where some works is required to be done. It is treated as a "Train" when running on rails.
RCRV	Rail-cum-Road Vehicle.
Registration and warranty	The formal process for operators to register and warrant rolling stock date with DFCCIL prior to being permitted to operate on the DFC network.

Rolling stock	Any vehicle which operates on or uses a railway track, excluding a vehicle designed for both on and off-track use when not operating on the track.
Rolling stock outline	The three-dimensional size of a railway vehicle including its movement that consists of three specific parts; the static outline, the basic kinematic outline and the swept kinematic outline.
Ruling grade	The maximum grade on a section of track used by the operator to determine the motive power required for a train and the load that can be hauled on that section of track.
Running Line	The line governed by one or more signals and includes connections, if any, used by a train when entering or leaving a station or when passing through a station or between stations.
Running Train	A train which has started under an authority to proceed from a station or yard and has not completed its journey.
Safe working rules and procedures	Rules and procedures issued by DFCCIL to mandate the requirements for safe operation on the DFC.
Safe working system	An integrated system of procedures and technology for the safe operation of trains and the protection of people and property on, or in the vicinity of the railway.
Scaled wheel	A build-up of metallic material on a wheel tread's surface. (Generally as a result of overheating from sticking brakes or dragging brakes causing wheels to side on the rail).
Sectional running times	The train running times between one location and the location in advance.
Shall	The word 'Shall' is to be understood as mandatory.
Should	The word 'Should' is to be understood as non-mandatory.
Skidded wheels	Flat areas on the wheel tread caused when wheels lock up under braking or seized axles and the wheel's slide or skid on the rail.
Special instruction	Instruction issued from time to time by the authorized officer in respect to particular case (s) or special circumstances;
Signal Control System	The system on which the points and signals are controlled by the Station Master at a station. The Signal Control System may consist of a VDU, Keyboard and mouse system or a Mimic with push buttons and switches.
Station Master	The Railway Servant/Qualified Worker on duty who is for the time being responsible for the working of traffic within station limits, and includes any person who is for the time being in independent charge of the working of any signals and responsible for working of trains under the system of working in force.
SWR	Station Working Rules.
Tower Wagon	A vehicle usually self-propelled, used for inspection & maintenance of overhead equipment
Train	A locomotive with or without vehicles attached, or any self-propelled vehicle with or without a trailer or vehicle (s) attached, which cannot be readily lifted off the track.
Train Control	The control and management of all rail operations on the DFC network.
Train Controller	A railway servant/qualified worker on duty who, for the time being is responsible for regulating the working of traffic on a section of a railway provided with communication.
Train Consist	A group of vehicles coupled together to form a train.
Train Manifest	The listed order of the vehicles arranged to make up a complete train.

Train Graph	The system used by Train Controllers to project, monitor and record the progress of trains over a section of track. The train graph may be on paper or electronic.
Train Number	A train or run number used to provide unique identification of a train.
Train Operator	An accredited 'Above Rail' operator of rail rolling stock consisting of locomotives and or rail vehicles, and can include track maintenance machines.
Train Parameters	The properties of a train the Train Operator is required to document as part of the marshalling process.
Train Path	The series of network segments over a particular interval through which a train can travel and may include stopping points and intervals and fuelling stations and other set down or changeover points (DFCCIL Access Agreement).
Train Protection Warning System (TPWS)	System to control train speed in case of signal passing at danger
TSWR	Traction Station Working Rule
TSWRD	Traction Station Working Rule Diagram
Thermal Cracks	Cracks in the running surface and adjacent areas of a wheel, caused by the thermal effect of heating and cooling resulting from on-tread friction braking.
Track	The combination of rails, rail connectors, sleepers, ballast, points and crossing, and substitute devices where used.
Track Circuit	An electrical circuit provided to detect the presence of vehicle on a portion of track, the rails of the track forming part of the circuit;
Track Maintenance Vehicle	A vehicle, usually self-propelled, used mainly for inspecting and maintaining track and infrastructure.
Track Speed	The allowable maximum train speed for a portion of track.
Traction Loco Control	The control & management of loco operations over DFC network
Traction Power Control	The Control & management of traction power for rail operations over DFC network
Unattended Station	A station where the points and signals are remotely operated from an attended station elsewhere and a Station Master is not normally on duty.
Vehicle	Any type of rolling stock that can operate on rail.
Wayside Monitoring Device	A device positioned on the rail network used to provide alerts of rolling stock or track infrastructure faults or anomalies.

2. DFCCIL Employee Responsibilities

2.1 Overview

DFC stations are divided into two categories i.e. junction station and crossing station. Stations having interface with Indian railway are Junctions stations and stations built for splitting section into block sections are termed as crossing stations.

All stations have a signal control system which, when required, will be operated by the SM or ASM to admit a train onto or off the DFC Network.

The SM or ASM shall operate the signal control system and shall only allow trains to enter the DFC network at a junction station when authorised by the DFCCIL train controller.

2.2 Duties of Station Master (Sr. Executive)

- a) Station Master is responsible for efficient discharge of duties by different members of staff at his station.
- b) Operating the signal control system as and when required.
- c) Ensuring that the general working of the Station is being carried out in strict accordance with the current rules, procedures and instructions.
- d) Providing prompt and courteous service with utmost safety and security of employees.
- e) Ensure availability, helpfulness and good conduct of Stations Staff.
- f) He shall be responsible for general up-keep of the station.
- g) He shall be responsible for keeping the safety and operating literature including circulars, pamphlets, gazette etc. up to date and these must be explained to the staff working under him and got noted by them.
- h) He shall be responsible for maintaining Accident register and Accident charts and keeping these up to date.
- i) He shall maintain figures in respect of the stock and get them relayed to the control in time.
- j) He shall promptly attend all accidents, assume charge of the site to and assist in relief measures. He shall take note of all the information available and protect and clues/evidence, which may be helpful in the enquiry. He shall intimate the control office at regular interval for current information and ask for the required assistance i.e., Relief Train, Medical van etc. He shall investigate yard accidents when directed, obtain statements of the staff responsible and submit his report with conclusions and joint note to the regional Office.
- k) He shall ensure that firefighting equipment at the station such as fire extinguisher, fire buckets etc. are in fine fettle and ready for use.
- l) The Station Master should regularly test and record in the charge book , the working of Points, "Signals and Axle Counter/Track Circuit to ensure that:
 - i) The Signals are back to 'ON' position when the relevant button is put back or intended train movement has been completed.
 - ii) It is not possible to take 'OFF' conflicting signals at the same time.
 - iii) Signals are not taken 'OFF' until all points are correctly set and facing points locked.
 - iv) Any other manner of testing prescribed by Authorized Officer.
 - v) Panel testing: Normal/Abnormal.
 - vi) At stations provided with continuous track circuits/Axle Counter or at stations having EI interlocking the method of testing shall be prescribed jointly by Signaling and Operating

Branch which shall be described in the Station Working Rules to be followed by station masters.

- m) He must ensure that the essential Safety equipment at his station are complete and if there is any deficiency it should be made good without delay.
- n) He shall conduct night and surprise inspections to check the alertness of staff and working of signals, and points and visibility of the signals.
- o) The Station Master shall inspect his station daily with a view to ensure efficient working of-
 - i) All equipment being in efficient working order. Deficiencies must be promptly rectified or recorded in Petty Repairs Book
 - ii) Safe and efficient working of trains.
 - iii) Station Manager's office, yards, and level crossing gates under his charge.
- p) He shall see that train signal register, station Diary, Inspection Note Book, reference books and other station record is properly maintained and preserved for a minimum period as prescribed.
- q) He shall fix up responsibility in case of detention to trains outside or at the station and submit full report to regional office.
- r) He shall be responsible to ensure that all the operating staff working under him is relieved in time for their periodical medical examination, refresher etc..
- s) He shall maintain close contact and co-ordination with Panel ASM ,wherever provided, for smooth running of trains and for better planning of operational work and will assist in case of any abnormal working.
- t) In case of abnormal working, he shall be responsible for manual operation (Hand Cranking) points and piloting of trains.
- u) At crossing Stations he shall also perform train passing duty.
- v) All instructions received from superiors shall be recorded in an Order Book. Senior officers should confirm these through a control order to avoid ambiguity. All such instructions shall be implemented, provided these do not violate safety rules & procedures.
- w) He shall be aware of TSWR, TSWRD & cautions to be observed in the electrified section.
- x) He shall ensure that all staff under him have signed the assurance register regarding precautions to be taken in electrified section.

2.3 Duties of Assistant Station Master (Executive) & Points Man (MTS)

The duties of each staff working at a station will be prescribed in the Station Working Rules for individual movement. Apart from the same, each of the staff shall note down the following additional duties indicated against each and observe them strictly.

2.3.1 Assistant Station Master (Executive):

- a) They will turn up their duty right time as per their roster and will not leave their duty until all train passing entries are correctly entered neat and clean in their duty hours till their duty roster.
- b) They will appear on their duty well dressed with Name badges so as to look Smart.
- c) They will pass trains efficiently, safely in their duty hours without any delay.
- d) They will always set the point against the Block line and will never adopt Short-Cut-Method for train passing.
- e) They will maintain Train Signal Register, Block Clearance Register, and Private Number Sheet neat and clean without over-writing.
- f) At the end of their duty, they will write physical position of the lines and Sign 'OFF' duty or 'ON' duty with their full Signature, date and time in Station Diary.
- g) They will exchange Alright Signal with Guard and Drivers of through passing trains with Green Hand Signal Flags/Hand Signal Lamp.

- h) If they happen to see any danger with the running train they will show Red Danger Signal to the Driver/Guard and take all possible steps to stop it in order to avoid derailment.
- i) They will not take off signals unless the line is clear and free from all obstruction for the safe passage of the train.
- j) They will never change the points in face of approaching train unless it warrants avoiding accident.
- k) They will obey all legal orders of Section Controller in respect of train passing.
- l) They will keep their essential equipment in good working condition and hand over the same to their relief.
- m) They will set Wall Clock in their shift hours once with Section Control.
- n) They will not allow entry of Un-authorized person in the Panel office.
- o) They will not allow handling of control cum indication Panel, Gears etc. by Un-authorized person.
- p) They will be extra-vigilant for train passing during foggy weather, disconnection of points and when relay room key has been given to S&T staff.
- q) They will keep their Telephones, Furniture neat and clean and will keep utmost devotion to duty.
- r) They must not go off duty until the train for which line clear has been given or obtained has reached the other end of the block section safely except when there is unusual delay due to accident or other abnormal circumstances.
- s) They will be responsible for safe passing of trains during failure of Home Signal & Starter Signal.
- t) They will attend all accidents/unusual occurrences at their station promptly and report to Station in charge, Sectional Traffic incharge and concerned officers.
- u) He will maintain the muster roll of staff working under him shift wise.
- v) He shall be aware of TSWR, TSWRD & cautions to be observed in the electrified section.

2.3.2 Pointsman (MTS):

- a) They will turn up on duty right time according to their roster, and will not leave their duty unless relieved by a competent person.
- b) They will wear uniform Name badges during their duty hours.
- c) They will obey all official orders given by SM/ASM
- d) They will clean SM/ASM office, Furniture, Telephones, Posters, and Photos etc. to the best satisfaction of SM on duty.
- e) They will clean essential equipment and keep them ready to use for Emergency use.
- f) They will not allow any Un-authorized person in the SM's office or to interfere with the safety equipment.
- g) They will hand-over T/369-3(b) stamped with DFCC logo & signed by SM/ASM to the locomotive pilot after checking facing points and will wave Green Hand Signal Flag from the foot of the signal to the locomotive pilot.
- h) They will assist SM/ASM on duty and hand over all necessary messages, Safety Forms as ordered by SM to the locomotive pilot and the Guard etc.
- i) They will supply drinking water to the SM on and when ordered by SM/ASM.
- j) They will maintain utmost devotion to duty and render all possible helps to the Railway staff.
- k) He should be aware of cautions to be observed in electrified sections.

2.4 Responsibility of DFCCIL Locomotive Pilot

DFCCIL Locomotive Pilots are responsible for proper operation of trains on the DFCCIL Network.

- a) Responsibilities include but are not limited to check :

- i) Prior to accepting a train from IR locomotive pilot to drive it on the DFCCIL network, the locomotive is provided with correct equipment in accordance with this Operations Manual and the DFCCIL Rules and Regulations;
 - ii) That the train consist is provided and is correct for operation on the DFCCIL network, and
 - iii) That the locomotive is clean and acceptable to the Locomotive Pilot's requirements.
- b) During the passage of the train:
- i) Drive the train in accordance with DFCCIL General rules and Procedures, Operations Manual and any other instruction;
 - ii) Monitor systems to ensure that the train is complete and no wagons have uncoupled.
 - iii) Remain alert at all times and comply with signal aspects, directions of the DFCCIL Train Controller and the Station Master at stations;
 - iv) Immediately report unusual to the Train Controller;
 - v) Report any delays to the train to the Train Controller;
 - vi) Act as DFCCIL Site Coordinator at accident/incident sites until relieved;
 - vii) Ensure that the locomotive cabin is maintained clean at all times, and
 - viii) Any other duties as prescribed.

2.5 Duties of Gateman

DFCCIL intends to introduce a system of working where the level crossing gates are completely eliminated. However, in exceptional cases the gate working may become unavoidable and gate working may be required during the transit period i.e. gate working may be required while ROB or RUB is under construction. Duties of gatemen under all such cases will be as follows:-

- a) At stations where gate is provided both for Indian Railway and DFCCIL lines and Indian Railway Gateman is provided, the responsibility of DFCCIL gateman shall be limited to assisting Indian Railway Gateman in gate operations.
- b) He shall be responsible for proper operation of the gate as per SWRs for the passage of trains.
- c) He shall ensure that no train suffers any detention on account of late closing of the gate.
- d) He shall keep the channels of check-rails clean and shall clean the road within the railway limits and water the area regularly.
- e) He shall clean the gate lamps and hand signal lamps daily.
- f) He shall keep the surroundings of his gate lodge clean tidy and neatly planted with shrubs, plants etc.
- g) He shall remain alert on duty till properly relieved. If he is required to leave the gate in an emergency he shall close and lock the gate booms against the road traffic before leaving the gate.
- h) He shall ensure that the equipment at Level crossing are complete and in working orders.
- i) He shall produce the public complaint book when required by public for lodging complaint and to the railway officials for inspection.
- j) He shall ensure that road traffic is not unnecessarily held up at the gate.
- k) He shall stand in attention near the gate lodge facing the track and be prepared to repeat any signal which the guard may intend to convey to the loco pilot or show caution or danger signal should anything appear to be wrong with the train (such as hanging part, hot axle etc.) itself as it passes.

- l) He shall be polite and courteous in his behavior towards the public.
- m) He shall report any defect in the gate to the ASM on duty without any delay.
- n) He shall close the gate on sighting a train or when ordered by the ASM on panel duty.
- o) He shall attract the attention of the loco pilots and guards by shouting and gesticulating instead of showing danger signal in case of train parting; he will show green flag up and down during day and white light during night.
- p) He shall obey all lawful orders of the SM on duty.
- q) In case of any obstruction, accident or damage to the gates, he shall protect the gate/obstruction as per instructions and rules in force.
- r) He shall ensure that the traction bonds at the crossing are intact and report any deficiency/defect are reported to Traction power controller immediately.

3. DFCCIL Train Controller Responsibilities

3.1 Overview

The DFCCIL train controller is responsible for controlling a designated area of track on the DFC and shall be competent in the train control board operations.

This may include but is not limited to:

- a) Interface arrangements for network entry and exit, and associated documentation;
- b) Route and infrastructure practical knowledge, including yards and other facilities;
- c) Communications equipment and facilities;
- d) Train control or signalling panels and associated facilities;
- e) Computing facilities;
- f) Train graphing and recording techniques;
- g) Emergency procedures, and
- h) Other office equipment.

Objectives of the control organization:

- a) To ensure proper running of goods trains.
- b) To ensure maximum utilization of the rolling stock
- c) To ensure maximum utilization of the section capacity
- d) To increase the speed of goods trains.
- e) Maximum utilization of the train crew.

3.2 Responsibilities of the DFCCIL Train Controllers

3.2.1 Chief Controller (In-charge)(Sr. Executive)

The chief controller will be overall Incharge of control office and shall be responsible for the total transportation of the Corridor on day to day basis. His duties include –

- a) A review of previous day's performance to conform that all forecasts have been fully met. For shortfalls, convincing reasons have to be pinpointed to prevent recurrence.
- b) Prepare current forecast indicating assistance needed from Corporate Office, adjoining corridor headquarter, adjoining Division and Railways.
- c) Assistance needed will generally relate to interchange, loading and locomotive utilization.
- d) Checking control chart and bringing to the notice of the Area Officer all avoidable detention to trains.
- e) Scrutiny of stock papers, Monitoring interchange obligation.
- f) Watching detention to stock at stations and terminals.
- g) Watching the work of yards/Freight terminals.
- h) Maintaining liaison with neighboring Divisions/ Corridor.
- i) Watching utilization of locos and their terminal detention.
- j) Checking duty hours of running staff and balancing of crews.
- k) Granting engineering, power blocks etc.
- l) Attending control office in cases of accident.
- m) Establishment work of control office.

3.2.2 Chief controller Movement / Dy. Chief Controller (Sr. Executive/Executive) / Shift duty:

He is responsible for:

- a) Running of goods train, preparing interchange forecast and monitoring the same, loco utilization.
- b) Deputy Chief Controller shall remain in constant touch with corridor HQ, adjacent corridor and adjacent IR Division through regular conference to facilitate the smooth flow of traffic.
- c) Dealing immediately with significant detention or transport bottleneck and other unusual.
- d) Keeping constant touch with the working of major terminals & yards and taking timely action to deal with congestion.
- e) Giving advice of serious accident to all concerned,
- f) Supervising the running of ODCs.
- g) Maintaining liaison with Traction loco controller and Traction power controller.
- h) Plan and grant maintenance blocks.
- i) Coordinate the work of various section controllers.
- j) Maintain discipline among control staff in the absence of Chief controller.
- k) Maintain coordination and liaison with various functionaries involved in train running.

3.2.3 Section Controller:

The Section controller shall be responsible for:

- a) Reporting for the duty at the prescribed time and ascertaining the position of the section from his reliever.
- b) Ensure accurate time is maintained and is used for all procedures and communications;
- c) Control and record each Authority and occupancy;
- d) Provide permission to DFCCIL SM or ASM at stations to allow trains to enter the DFC network after confirming that the train will effectively reach its destination and exit the DFC network;
- e) Accurately record:
 - i) The progress of train on the 'Control' graph including crossing, connections and shunting reasons for detention etc.
 - ii) Communications, signalling and other infrastructure conditions as necessary for the safe and efficient operation of the network. Advising stations in advance of the work to be done on trains on move.
- f) When vehicles are detached short of their destination at an unattended location, record and maintain the status of the vehicle for subsequent movement as required for the train operator concerned;
- g) Ensure changes are recorded to train length, tonnage, locomotives and other operational information, and provide the information to the train controller in the adjoining jurisdiction as required;
- h) Informing lobby and stations about the late running of the trains to avoid the calling of Crew earlier than necessary or to put back train wherever advisable.
- i) Informing major stations and concerned Section controller about the current running of trains on the section and their anticipated arrivals well in time.
- j) Keeping in close touch with concerned department regarding blocks of material trains and working of material Trains so as to give the maximum possible time with least detention to other traffic.
- k) Incident management to include adjusting movement of the trains in view of the likely impact of the incident, informing all concern.
- l) Keeping a watch over damaged vehicles detached at road side stations and arranging repair or transshipment of their contents and proper attention on the part of the train examining staff.
- m) Arrangement of ART & Material Van in case of accident.

- n) Eliminating all possible detention to train and stock.
- o) Watching the working of Yards & major terminals.
- p) Making timely arrangements for the relief of Guards/Loco pilots whose duty Hours are likely to exceed enroute.

3.3 Vigilance

Train controllers shall remain vigilant at all times and promptly respond to:

- a) Emergencies;
- b) Unusual occurrences;
- c) The requirements of safeworking;
- d) Incoming radio transmissions;
- e) Incoming telephone calls, fax and other communications, and
- f) Train notices, circulars and other instructions.

3.4 Train Control Hand Over

- a) Before assuming responsibility for a train control jurisdiction, hand over procedures shall be conducted and shall involve:
 - i) The outgoing train controller, and
 - ii) The incoming train controller.
- b) The outgoing train controller shall not depart until an understanding is reached in relation to:
 - i) Projected train working;
 - ii) Projected train paths;
 - iii) The actual position and status of each train;
 - iv) The status of signal and points at stations;
 - v) The status of Authorities and information;
 - vi) The status of track and other infrastructure including track out of service, failures etc.; and
 - vii) Log book or other records that could affect safety and operations.
- c) The incoming train controller shall check train graph or other recording facilities, if being used, for the correct recording of temporary speed restrictions and other information pertinent to operations and safety.
- d) The outgoing train controller shall:
 - i) Ensure that the incoming train controller is fully briefed on all aspects of the working, and
 - ii) Complete any outstanding reports and computer data entries which were not able to be completed during the shift.

3.5 Interface between Train Control Jurisdictions

- a) An interface between train control jurisdictions occurs in the following circumstances:
 - i) Where two or more train control jurisdictions are physically adjacent (such as IR), and
 - ii) At locations where trains enter, exit or cross the DFC network, for example:
 - At interface stations;
 - Yard or terminal locations;
 - Junctions; or

- Any other situation where the control of facilities is not the normal responsibility of the DFCCIL train controller, with responsibility for the adjacent network running lines, but the facility is connected to the network running lines.

- b) The interface between train control jurisdictions may be undertaken from the same or different train control offices or locations. Train controllers whose jurisdictions interface with another jurisdiction shall discuss as frequently as necessary to reach understanding in relation to:
- Anticipated train arrival and departure times;
 - The planning of train paths;
 - Train identification details; and
 - Crossing and passing requirements as appropriate.
- c) Before authorising a movement to proceed to or from a location where the working beyond that location is controlled by another jurisdiction, permission from that jurisdiction shall be first be obtained.

3.6 Reporting Train Performance

- a) The DFCCIL train controller shall report on train performance in terms of time lost or gained by each train in relation to:
- Trains exceeding or running better than section running times;
 - Trains exceeding or using less time than scheduled for activities such as crossing, passing, shunting, fuelling, crew changes etc., and
 - Time lost as a result of unscheduled events, including incidents and train prioritisation decisions.
- b) The DFCCIL train controller shall not assume the reason for delay but where time has been lost, the reason shall be sought from:
- The SM or ASM at a station where the delay has occurred;
 - The Locomotive Pilot, where the delay has occurred during transit, or
 - The track maintainer, where the delay has occurred due to track or infrastructure works.
- c) Train performance, including reasons for delays, shall be reported for each station. This may require the DFCCIL train controller to do one or more of the following:
- Accurately input information into computing systems;
 - Accurately record information on train graphs;
 - Produce specialised reports, and
 - Where 'codes' are used to describe delays or incidents, use these and provide an additional explanation where the code is not sufficient.

4. DFCCIL Train Control System

4.1 Overview

The DFCCIL train controller is in charge of all rail activities over the area of control on the DFC network and no rail movement, or track occupancy may occur without the authority of the DFCCIL train controller.

Station employees, Locomotive Pilots and other workers requiring access to the DFC network shall comply with all instructions issued by the DFCCIL train controller provided the directions consistent with the General Rules and Procedures, and other instruction.

4.2 Train Control Communications

4.2.1 Overview

Train controllers are responsible for communicating with each other the projected train working at the interface to ensure that trains pass through the interface in a planned and timely manner.

Where there are parallel lines, the DFCCIL and IR train controllers shall communicate with each other, should an abnormal event or emergency occur that may affect the safety of train running within the area of control.

4.2.2 Using Train Control Telephone

The DFCCIL train control telephone is to be used for operational purposes only and all transmissions shall be clear, concise and polite.

When there is requirement to communicate with Train Control, the person wanting to talk to the train controller shall:

- a) Lift the Train Control handset and listen to ensure it is not in use and announce their identity i.e. station name etc.;
- b) Wait for the train controller to respond;
- c) Commence transmission with the train controller
- d) Repeat any direction issued by the train controller to ensure it is correct;
- e) Ensure the train controller has understood information provided, and

In the event that there is requirement to urgently contact the train controller owing to an emergency, the words 'Emergency, Emergency, Emergency' shall be broadcast into the train control phone irrespective if it is already in use, and when acknowledge by the train controller, the details of the emergency may then be transmitted.

When an emergency call is heard on the train control phone, other users shall cease transmission to allow the train controller to deal with the emergency call.

4.2.3 Using GSM-R based Train Control Radio

The DFCCIL train control radio used for operational purposes only and all transmissions shall be clear, concise and polite.

When there is requirement to communicate with Train Control, the person wanting to talk to the train controller on the train control radio shall:

- a) Listen to ensure that the radio is free and available for use;
- b) Speak in announcing the train number, locomotive number or other distinct contact name and the word 'Speaks';

- i) Wait for the train controller to respond;
- ii) Commence transmission with the train controller;
- iii) At the end of each transmission, use the word 'over' to confirm that the train controller can respond;
- iv) Repeat any direction issued by the train controller to ensure it is correct;
- v) Ensure the train controller has understood information provided, and
- vi) At the end of the transmission, the train number, locomotive number or other distinct contact name and the word 'Finish'.

In the event that there is requirement to urgently contact the train controller owing to an emergency, the words 'Emergency, Emergency, Emergency' shall be broadcast on the train control radio irrespective if it is already in use, and when acknowledge by the train controller, the details of the emergency may then be transmitted.

When an Emergency call is heard on the train control radio, other users shall cease transmission to allow the train controller to deal with the emergency call.

4.2.4 Emergency Call through GSM-R

Details are provided in chapter 26.

4.3 DFCCIL Train Control Permission

4.3.1 Overview

Permission of the DFCCIL train controller shall be obtained when:

- a) A train requires to enter or exit the DFC network from / to the IR network;
- b) Trains operating on the DFC require to depart from a station, junction, terminal, yard or siding;
- c) Prior to the DFC SM or ASM signalling an approaching train to pass through a DFCCIL station;
- d) Trains require to shunt onto or from the DFC network, or
- e) Any other rail activity requires to occur on the DFC main lines.

At stations or junctions that interface with the IR network, the DFCCIL SM or ASM shall contact the IR SM, ASM or train controller prior to allowing a train the exit the DFC network onto the IR network.

The DFCCIL SM or ASM shall ensure that the permission of the DFCCIL train controller is obtained prior to routing a train at the station.

Train operators shall not request entry onto the DFC network unless the train movement has been planned and all the required details have been provided.

Train operators shall not request to be routed into a DFC siding unless it has been planned and agreed with DFCCIL.

The DFCCIL train controller may, at discretion, permit a train to operate on the DFC network, or enter a siding in special circumstances.

4.3.2 Train requiring to enter DFCCIL from IR Network

The DFCCIL SM or ASM shall not operate the signalling for a train to enter the DFC network from the IR network without the permission of the DFCCIL train controller.

When advised by the IR SM or ASM, or IR train controller that a train requires to proceed from the IR network to the DFC network, the DFCCIL SM or ASM shall contact the DFCCIL train controller and request permission to accept the train.

The DFCCIL train controller shall not give permission for a train to enter onto the DFC network unless:

- a) The train is planned to operate on the DFC network;
- b) The train operator has provided the required train documentation for the train to operate on the DFC network;
- c) The Locomotive Pilot has contacted the DFCCIL train control to test communications and provide train details;
- d) The train is correctly equipped to operate on the DFC including:
 - i) Correct locomotives when entering the Corridor, and or
 - ii) End of Train Telemetry, or a guard in a brake van in exceptional cases with the prior permission of DFCCIL control.
- e) The DFCCIL train controller has been provided the locomotive and train running details for the train,
- f) The DFCCIL train controller has been provided details of the train working including:
 - i) Shunting requirements on the DFC;
 - ii) Required Locomotive Pilot and guard (where applicable) changes along the DFC;
 - iii) Changes to locomotives or brake van whilst operating on the DFC, and
 - iv) Any other activity that may have an effect on train operations on the DFC network.
- g) The train is ready to enter the DFC network unimpeded.

The DFCCIL train controller shall ensure that the correct conditions exist, as detailed, and provided the train can be accepted, provide permission to the DFCCIL SM or ASM to accept the train and including any other instructions applicable to the trains operation.

Upon receiving permission, the DFCCIL SM or ASM may operate the signalling to allow the train to be signalled onto the DFC network and confer with the IR SM, ASM or IR train controller to allow the train to proceed.

The DFCCIL SM or ASM shall record the time the train enters the DFC network and report the time to the DFCCIL train controller.

If for any reason the train does not proceed expeditiously toward the DFC network as planned, the DFCCIL SM or ASM shall immediately seek the reason from the IR SM, ASM or IR train controller, and then advise DFCCIL train controller and seek further instruction regarding passage of the train.

Should the DFCCIL train controller provide an instruction that the train can no longer be accepted, the DFCCIL SM or ASM shall immediately advise the IR SM, ASM or IR train controller and arrange for the train to remain at its current location pending further direction.

The DFCCIL SM or ASM shall not cancel the signalling for the train unless it has been confirmed that the train is stationary and it is safe to do so.

4.3.3 Train Requiring to Proceed from DFCCIL to IR network

4.3.3.1 Train Controller Requirements

The DFCCIL train controller shall not allow a train on the DFC to approach a junction station unless it is ensured that the train can be signalled of the DFC network toward the IR network without delay.

Upon the train approaching the station in the rear of the junction station, the DFCCIL train controller shall liaise with the IR train controller and establish that the train can be accepted onto the IR network.

If the train cannot be accepted onto the IR network, the DFCCIL train controller shall arrange for the train to be stopped at the station in the until it has been confirmed that the train can be accepted.

If the DFCCIL train controller considers that the train can be advanced to the junction station without interruptions to other rail operations, the train may be advanced to the junction pending acceptance onto the IR network.

4.3.3.2 Junction Station Requirements

When a train requires to depart from the DFC network and proceed onto the IR Network, the DFCCIL SM or ASM shall seek permission from the DFCCIL train controller.

Provided the DFCCIL train controller has granted permission, the DFCCIL SM or ASM shall contact the IR SM or ASM, or IR train controller and seek permission for the train to be signalled toward the IR Network.

The IR SM or ASM, with the permission of IR train controller shall operate the signalling to accept the train and allow the DFCCIL SM or ASM to signal the train toward the IR Network.

Should the train be delayed, the DFCCIL SM or ASM shall advise the IR Station Master or IR train controller of the delay and seek further direction. The DFCCIL train controller shall also be advised.

Immediately the train exits the DFC network, the DFCCIL SM or ASM shall record the train departure and advise the DFCCIL train controller.

4.3.4 Train requiring to depart DFCCIL Station, Terminal or Siding

The DFCCIL SM or ASM shall not signal a train to depart from a station, junction or siding without first obtaining the permission of the DFCCIL train controller.

When advised that a train is ready to depart, the DFCCIL SM or ASM shall contact the DFCCIL train controller and request permission to signal the train to depart.

The DFCCIL train controller shall not give permission for a train to depart unless:

- a) The train is planned to operate on the DFC network;
- b) The train operator has provided the required train documentation for the train to operate on the DFC network;
- c) The Locomotive Pilot has contacted the DFCCIL train controller to test communications and provided train details;
- d) The train is correctly equipped to operate on the DFC including:
 - i) Correct locomotives when entering the Corridor, and or
 - ii) End of Train Telemetry, or a guard in a brake van only in exceptional cases with the permission of DFCCIL control;
- e) The DFCCIL train controller has been provided the locomotive and train running details for the train,
- f) The DFCCIL train controller has been provided details of the train working including:
 - i) Shunting requirements on the DFC;
 - ii) Required Locomotive Pilot and guard (where applicable) changes along the DFC;
 - iii) Changes to locomotives or brake van whilst operating on the DFC, and
 - iv) Any other activity that may have an effect on train operations on the DFC network.
 - v) The train is ready to depart unimpeded.

The DFCCIL train controller shall ensure that the correct conditions exist, as detailed, and provided the train can be accepted, provide permission to the DFCCIL SM or ASM to signal the train to depart and also any other instructions applicable to the trains operation.

Upon receiving permission, the DFCCIL SM or ASM may operate the signalling system to allow the train to be signalled to proceed.

The DFCCIL SM or ASM shall record the time the train departs and report the time to the DFCCIL train controller.

If for any reason the train does not depart as planned, the DFCCIL SM or ASM shall immediately seek the reason from the Locomotive Pilot, and then advise DFCCIL train controller and seek further instruction.

Should the DFCCIL train controller provide an instruction that the train can no longer be allowed to move due to changed network conditions arising out of delay in departure, the DFCCIL SM or ASM shall immediately advise the Locomotive Pilot and arrange for the train to remain at its current location pending further direction.

The DFCCIL SM or ASM shall not cancel the signalling for the train unless it has been confirmed that the train is stationary and it is safe to do so.

4.3.5 Train Requiring to Proceed through DFCCIL Station or Junction

4.3.5.1 Signals at Stations located on double line automatic section

Where signals at DFCCIL stations are normally in Auto mode, they will operate automatically to proceed after the passage of each train, and will only be operated to stop when required

At DFCCIL stations where signals are in auto mode, the DFCCIL SM or ASM shall not place signals to stop a train unless directed by the train controller.

4.3.5.2 Stations where signals are not in Auto Mode located on double line automatic section

At stations or junctions where the signals do not operate in Auto mode, the signals must remain at stop and the DFCCIL SM or ASM shall not place the signals to proceed for a train without the permission of the DFCCIL train controller.

When advised that a train is approaching a station, the DFCCIL SM or ASM shall contact the DFCCIL train controller and seek instructions regarding the passage of the train.

The DFCCIL train controller shall provide the necessary instructions to the DFCCIL SM or ASM regarding the trains working.

If the train is to continue, the DFCCIL SM or ASM shall operate the signals to proceed for the train's passage.

If the train is to stop or to be placed into the station siding, the DFCCIL SM or ASM shall to operate the applicable points and signals to route the train as directed by the DFCCIL train controller.

The DFCCIL SM or ASM is to provide time updates to the DFCCIL train controller regarding the train movement at the station.

4.3.5.3 Stations on single line absolute block section

At single line absolute block section train reception, dispatch or run through, line nomination shall be done by the DFCCIL controller and SM shall follow all valid instructions of Train controller in this regard.

4.3.6 Shunting on running lines

The DFCCIL SM or ASM shall not allow a train to shunt onto the main running lines without the permission of the DFCCIL train controller. The request for shunting shall be made by the Operator before the train enters DFCCIL network along with the details such as the location where shunting needs to be done, reason thereof, the wagons to be detached attached etc. DFCCIL control shall give prior permission for the shunt operation before the train enters DFCCIL network.

The DFCCIL train controller shall not allow trains to shunt on the main running lines unless the shunting will not impact on train operations.

In case of emergency, when there is a need to shunt a train due to wagon defect etc. and the DFCCIL SM or ASM receives a request from a train operator to shunt on the main line, the DFCCIL SM or ASM shall establish from the train operator:

- a) The reason for the shunt;
- b) Consist details of the train shunting (number of wagons and locomotive Number), and

- c) The proposed durations of the shunt.

The DFCCIL SM or ASM shall then communicate the details to the DFCCIL train controller and seek permission for the shunt to take place.

The DFCCIL train controller shall;

- a) Confirm that the shunt movement will not affect train operations;
 - i) If the shunt will affect train operations, deny permission and provide details of the reason, or
 - ii) If the shunt can proceed, provide permission for the shunt to take place.
- b) Record the outcomes of the shunting request, and
- c) Monitor the shunting activities to ensure that it occurs within the timeframe as requested.
- d) The DFCCIL SM or ASM shall then signal the shunt movement.

4.3.7 Stabling on DFCCIL Network

DFCCIL network is not designed to undertake stabling operations and these should be avoided to the extent possible. In exceptional cases, following procedure and precautions should be adopted:

- a) The Station Masters shall ensure that each vehicle standing at their stations are so placed and secured that they do not and cannot obstruct other lines in the manner specified below-
 - i) Vehicles shall be coupled together and hand brakes applied,
 - ii) the vehicles shall be secured with safety chains fastened to the rail and padlocked and the sprags or wooden wedges or skids shall also be used to prevent rolling down of vehicles;
- b) As far as possible, such vehicles shall be stabled on lines that are isolated from the running lines;
- c) Whenever one or more vehicles are detached from a train-
 - i) before the locomotive of the train is detached to shunt the vehicle(s), the competent DFCCIL/Railway servant provided for shunting, or in his absence the Assistant Loco pilot of the locomotive shall ensure that brakes of the portion of the train being left behind is adequately secured against any movement which may obstruct the adjacent line;
 - ii) before uncoupling the vehicle(s) being stabled it shall be ensured that they have been secured as in clause above.
 - iii) No detached vehicle shall be kept on a running line at any time.
- d) In case of stabling of full load:
 - i) a minimum of six wagons at each end, in a load of upto 60 vehicles, shall be secured by either applying hand brakes by assistant Loco pilot and secured with at least two safety chains one at either end fastened to the rail and padlocked by the Station Master. Further at least four sprags/wooden wedges be used, two each below the outermost pair of wheels. In case the load exceeds 60 vehicles it shall be treated as two separate loads;
 - ii) The vehicles of stabled load shall be coupled together. In case, the stabled load has to be split for any reason and also in case of a long haul train each split part shall be treated as a separate load for the purpose of securing;
 - iii) when stabled on a running line, action as per extant instructions shall also be taken and remarks made in TSR in red ink to the effect that "line No..... " is blocked.

- iv) Normally a full train shall not be stabled on a running line having gradient more than 1 in 400 except in emergency at stations where stabling is allowed in Station Working Rule.
- v) In case of stabling of train with locomotive attached or stabling of light engine(s) before shutting down the locomotive, the Loco pilot shall additionally ensure that every given brake, including hand brake and parking brake have been applied, and locomotive secured with wooden wedges.
- e) In case a train is stalled in block section besides protecting the train in terms of DF GR 9.17, the vehicles shall also be secured when either the locomotive is to be detached or being shut down or a portion of the train is left behind or the continuity of brake has been affected due to accident.

4.4 Advise of Train Stopping on the DFCCIL Main Line

When advised that a train has come to a stand unexpectedly on the main line, the DFCCIL train controller shall establish the reason from the Locomotive Pilot.

If the Locomotive Pilot is unable to give reason, or it is considered that the train may be obstructing a parallel line the DFCCIL train controller shall:

- a) Use Emergency alert to inform all the trains running either on DFCCIL or IR network in vicinity of the stopped train and direct trains to approach the location cautiously prepared to stop.
- b) Immediately communicate with the train controller of any parallel line and provide details of the stationary train;
- c) Advise the traction power controller of the stationary train and establish if there has been any disruption to the overhead traction supply,
- d) Advise the DFCCIL SM or ASM at either end of the section of the stationary train and request Signals to be placed at 'ON' if required.
- e) Put in place emergency management protocols.

Once it has been established that no parallel lines are obstructed and it is safe for trains to pass, the DFCCIL train controller shall advise the train controller of the parallel lines and any other trains operating on the DFC network.

The Station Master or Assistant Station Master at the station **of** end may also be directed to place the signalling to proceed.

4.5 Advise of Train Stopping on the Parallel Line

When advised by the parallel line train controller, or other employee that a train has come to a stand on a parallel line and the cause cannot be established, the DFCCIL train controller shall:

- a) Advise trains on the DFC network within the vicinity using emergency alert and provide details of the stationary train and direct trains to approach the location cautiously prepared to stop,
- b) Advise the DFCCIL SM or ASM at either end of the section of the stationary train and request signals to be placed at 'ON' if required.
- c) Put in place emergency management protocols.

Once it has been established that no parallel lines are obstructed and it is safe for trains to pass, the DFCCIL train controller shall advise any trains operating on the DFC network

The Station Master or Assistant Station Master at the station end may also be directed to place the signalling to proceed.

5. DFCCIL Traction Power Control System

5.1 Overview

DFCCIL Traction Power Control is located in the respective DFCCIL train control centres and are responsible for:

- a) Monitoring the overhead power supply over the allocated area of control;
- b) Guide the DFCCIL train controller, SM or ASM at stations, Locomotive Pilots and other operating staff in dealing with issues associated with the overhead power supply;
- c) Arranging maintenance blocks for the overhead equipment;
- d) Arranging alternative power supply in case of tripping etc., through remote control;
- e) Monitoring overhead equipment failures and taking remedial action;
- f) Monitoring detention of trains owing to overhead equipment issues;
- g) Authorising the manual isolation of the overhead power supply, and
- h) Responding to emergencies and incidents where the overhead power supply may be or is affected.

A DFCCIL traction power controller is allocated to specific areas of control and shall work closely with the train controller to ensure efficient operation of the DFC.

5.2 General Responsibilities of the DFCCIL Traction Power Controller

The DFCCIL traction power controller shall be responsible for direct control of the 2X 25 kV power supply for electric traction and shall be fully acquainted with all the traction power supply installations, and sectionalizing arrangements.

When on duty the traction power controller shall:

- a) Remain acquainted with the prevailing position of the entire section and review any special instructions to be carried out.
- b) Maintain continuous contact with power supply authorities to ensure continuous power supply;
- c) Maintain continuous contact with the DFCCIL train controller in regard to power supply affecting train movements;
- d) In the event of power supply interruptions or other failures, take prompt action in accordance with prescribed rules and local instructions for restoration of supply;
- e) Imposition of and removal of power blocks as required, following the prescribed procedure and safety rules;
- f) In the event of power supply failures, advise promptly the concerned DFCCIL maintenance team and management, and keep them posted with developments, and
- g) Record in the Log Book, full details of all switching operations carried out, power blocks imposed or refused (or delayed) and other occurrences in the distribution system;

5.3 Traction Power Control Communications

Locomotive Pilots encountering issues with the overhead equipment shall report the issue to the DFCCIL train control and seek assistance to resolve the issue.

The DFCCIL train controller may request the Locomotive Pilot to directly communicate with the DFCCIL traction power controller if it is considered more appropriate.

Each station and junction is provided with phone communications providing the DFCCIL SM or ASM direct communications with the DFCCIL traction power controller.

When communicating with the DFCCIL traction power controller the SM or ASM shall ensure correct information about the condition of overhead equipment and its location is relayed and all discussions are understood.

6. DFCCIL Traction Locomotive Control/Crew Control

6.1 General Responsibilities of the Locomotive Controller

The DFCCIL Locomotive Controller is located in the respective DFCCIL train control centres and are responsible for:

- a) Ensuring IR or the respective Train Operator have provided sufficient locomotive resources to allow effective operation of trains in the DFCCIL network;
- b) Liaise with IR or the respective Train Operator regarding issues associated with locomotive allocation and arrange changes as may be required;
- c) Liaise with IR or the respective Train Operator when a locomotive becomes defective and make arrangements for relief locomotives to assist the train operations;
- d) Liaise with the Traction power Controller for issues associated with traction power/OHE;
- e) Where locomotives are detached from trains, liaise with the IR or the respective Train Operator, regarding repair of the locomotives and the clearing of the locomotives from the DFCCIL network;
- f) Liaising with the DFCCIL Train Controller regarding issues associated with locomotives and resolution actions;
- g) Liaise with nominated loco inspector for assistance to loco pilot in trouble shooting any abnormality enroute.
- h) Monitoring of locomotives operating on the DFCCIL network, and
- i) Ensuring locomotives are allocated to work trains operating on the DFCCIL network.

A DFCCIL locomotive controller is allocated to specific areas of control and shall work closely with the train controller to ensure efficient operation of the DFC

6.2 Protocol for removing a defective Locomotive

- a) DFCCIL will be responsible for the management of rolling stock including locomotive whilst a train is operating on the DFC in conjunction with the train operator.
- b) If a locomotive is found to have a fault on the DFC, the level of the fault needs to be determined by the Locomotive Controller who must establish if it requires immediate repair at the location of the train, or if the train is able to be worked to the next station and the defective locomotive can be safely placed into the siding at that station pending repairs.
- c) The determination that a defective locomotive can be moved is the responsibility of the 'train operator' in liaison with the Locomotive Controller, who will be required to provide a guarantee to DFCCIL that the train can be worked with the locomotive attached and the conditions under which it will operate to ensure that no network infrastructure damage will occur.
- d) DFCCIL may accept the advice of the train operator, or reserve the right to reject it and insist that the affected locomotive be removed from the network at its current location, or repairs be effected prior to the locomotive being moved.

When placing the defective locomotive into a siding at the next station, the train operator will be responsible for effecting repairs that will enable the locomotive to resume service, or be relocated to the next available maintenance depot for further repairs. DFCCIL may assume such responsibilities only to the extent that the defective locomotive exits the DFCCIL network without any further disruptions or adverse impact on performance.

7. DFCCIL Wagon Control

7.1 General Responsibilities of the Wagon Controller

The DFCCIL Wagon Controller is located in the respective DFCCIL train control centres and are responsible for:

- a) Ensuring Rail Operators have provided train consist for the operation of trains on the DFCCIL;
- b) Ensure that the wagons allocated on a train is suitable for operation in the DFCCIL network;
- c) Liaise with Above Rail Operators regarding issues associated with wagon allocation and arrange changes as may be required;
- d) Liaise with Above Rail Operators when a wagon becomes defective and make arrangements for the removal of the wagon;
- e) Where wagons are detached from trains, liaise with the Above Rail Operators, repair of the wagon and the clearing of the wagon from the DFCCIL network;
- f) Liaising with the DFCCIL Train Controller regarding issues associated with train consists and resolution actions;

A DFCCIL wagon controller is allocated to specific areas of control and shall work closely with the train controller to ensure efficient operation of the DFC.

7.2 Protocol for removing a defective wagon

- a) DFCCIL will be responsible for the management of rolling stock whilst a train is operating on the DFC in conjunction with the train operator.
- b) If a wagon is found to have a fault on the DFC, the level of the fault needs to be determined by the Wagon Controller who must establish if it requires immediate repair at the location of the train, or if the train is able to be worked to the next station and the defective wagon placed into the siding at that station pending repairs.
- c) The determination that a defective wagon can be moved is the responsibility of the 'train operator' in liaison with the Wagon Controller, who will be required to provide a guarantee to DFCCIL that the train can be moved with the wagon attached and the conditions under which it will operate to ensure that no network infrastructure damage will occur.
- d) DFCCIL may accept the advice of the train operator, or reserve the right to reject it and insist that the affected wagon be removed from the network at its current location, or repairs be effected prior to the wagon being moved.

When placing the defective wagon into a siding at the next station, the train operator will be responsible for effecting repairs that will enable the wagon to resume service, or be relocated to the next available maintenance depot for further repairs. DFCCIL may assume such responsibilities only to the extent that the defective stock exits the DFCCIL network without any further disruptions or adverse impact on performance.

8. Train Operator Requirements on DFC Network

Introduction

In the starting phase IR will be the sole operator over DFC. It is expected that MOR will subsequently establish the legal and operational framework to allow Operators other than IR to access DFC network. The operator requirement for two phases as outlined above will differ. When IR is the sole operator, IR and DFCCIL will establish an operating protocol containing at least following indicative items:-

- a) General Train Planning
- b) Train identification numbering
- c) Time table for running of scheduled freight trains
- d) Transfer of traffic as per concession agreement
- e) Network information to be provided to IR
- f) Information exchange between IR and DFCCIL through FOIS and TMS
- g) Communication protocol
- h) Train requirement for entry into DFC
- i) Crew requirement and working of crew
- j) Train length
- k) Brake Power certificate and train braking requirement
- l) EOTT and brake van
- m) Movement of ODC
- n) Non acceptance and regulation of trains
- o) Shunting on DFC
- p) Speed restrictions
- q) Working of trains with Locotrol
- r) Supply of stock for loading in Sidings/PFTs/Ports directly connected with DFC.
- s) Rolling stock requirement on DFC network
- t) Protocol for handling Defective rolling stock and locomotives on DFC network
- u) C&W examination of rolling stock operating on DFC.
- v) KPIs
- w) Incidents and notifiable incidents
- x) Accident and Unusual.
- y) Accident Enquiry
- z) Safety performance compliance monitoring and review.

It is expected that to allow Operators other than IR, MOR will establish a legal and executive framework to address following issues:-

- a) Licensing of Rail Operators: Licensing of operators will mainly address the financial and technical capability or the Operator and relationship between MOR, Operator and DFCCIL.
- b) Safety: For establishing the safety system required to be complied by the operators, MOR may set up a regulator or an executive body backed by Legislation or executive orders. The institution set up will establish the requirement for
 - i) Rolling stock & Locomotive – Registration, maintenance and operation over DFC and IR.
 - ii) Manpower : Competence, training, fit to work, drug and alcohol requirements while on duty
 - iii) Incident and unusual reporting
 - iv) Accidents and Accident enquiry.

Operators may be required to set up a Safety Management System to ensure compliance to the items listed above. A review and compliance monitoring body may also be established to ensure satisfactory compliance with the requirements of the SMS.

This chapter seeks to lay out the details of Operator requirements for

- i) Rolling stock & Locomotive
- ii) Manpower, Medical Standards, Hours of Work, Competence
- iii) Safety performance monitoring and review
- iv) Other Requirements

Train Operator Requirements

A. Staff Requirements

8.1 Operators requiring to operate rolling stock on the DFC Network shall comply with applicable DFCCIL safety and operating requirements. Train operators accessing to the DFC Network and DFCCIL shall:

- a) Identify rail safety related worker functions undertaken within their operations.

These include but are not limited to:

- i) Driving and operation of trains;
 - ii) Controlling and signaling the movement of trains;
 - iii) Working on track infrastructure or rolling stock;
 - iv) Shunting and terminal operations, and
 - v) Other activities that require employees to be on or near the track that require either training or supervision.
- b) For each of the functions identified, determine for each individual worker the following:
 - i) Capacity to perform the function; and
 - ii) Competence.
 - c) For each of the functions identified, specify and maintain the following:
 - i) Medical standards;
 - ii) Operations, required competence, and
 - iii) Engineering systems competence.

8.2 Guidelines for Medical Standards

DFCCIL and train operators are responsible for ensuring that employees are medically capable of undertaking nominated functions in a safe manner.

8.3 Drug and Alcohol

DFCCIL and train operators are responsible for ensuring Zero alcohol and drug impairment policies are in place and employees shall not breach the prescribed concentration of alcohol and be free from the influence of other drugs when about to, or engaged in carrying out rail safety related worker functions on the DFC network.

DFCCIL and train operator shall have in place systems that include but not limited to:

- a) Intermittent or random testing of all employees;
- b) Testing when it is suspected that an employee is attempting to start work under the influence of alcohol or other drugs;
- c) Testing after incidents or accidents where the involvement of alcohol or other drugs could be a factor, and

- d) DFCCIL and train operators shall ensure compliance with relevant regulations and directives related to detection and quantification of drugs of abuse in urine of employees.

8.4 Hours of Employment and Periods of Rest Rules

Fatigue shall be recognised by DFCCIL and train operators as a workplace hazard and hours of employment and periods of rest policies as laid down through the prevailing acts and regulations shall be adopted when operating on the DFC Network.

DFCCIL and train operators shall manage the risks associated with the hazard of fatigue in accordance with their relevant safety systems and measures.

These systems and measures shall include:

- a) A policy that recognises the shared responsibility of employees,
- b) Details risk minimising strategies and clearly defines responsibilities for managing fatigue,
- c) Training and education programs for railway servants involved in shift work, and
- d) Systems to determine levels of fatigue associated with hours of work including overtime and the maintenance of records for audit purposes.

8.5 Competencies

8.5.1 Operations and Safety

DFCCIL and train operators shall ensure that systems for the development and maintenance of employee competence are in place and take into account the following:

- a) Employees shall be certified as competent in the relevant safety requirements described in the DFCCIL General Rules, Procedures and other manuals and instructions;
- b) Assessments should be conducted according to the level of risk arising from the work carried out for each employee;
- c) The maximum period between assessments for any employee shall be no longer than three years;
- d) Where the requirement for assessment exceeds the specified period by more than three months, the employee not completing the re-assessment shall not carry out any operational and safety functions on the DFC network;
- e) An employee's safety competence shall be re-assessed, according to the level of risk arising, where the worker has not engaged in performing operational safety for a prolonged continuous period and be withdrawn if the continuous period exceeds twelve months. Reinstatement shall occur once re- assessment is successfully completed, and
- f) An employee's competence shall cease to be recognised where such competence has been withdrawn or suspended.

8.5.2 Route or Area Specific Competence

DFCCIL and train operators shall ensure that systems for the development and maintenance of route or area specific competencies take into account the following:

- a) For driving and operation of trains:
 - i) Network route knowledge;
 - ii) Yard competencies for DFC sidings, junctions and stations including those on the adjoining network, and
 - iii) Communication protocols and interfacing requirements.
- b) For controlling and signalling the movement of trains:
 - i) Control room, panel, or signal box competency, and
 - ii) Communication protocols and interfacing requirements.
- c) For work on infrastructure or rolling stock:

- i) Route, yard, infrastructure and rolling stock knowledge as applicable for the work to be undertaken, and
 - ii) Communication protocols and interfacing requirements.
- d) For shunting and terminal operations:
- i) Yard and infrastructure knowledge as applicable for the work to be undertaken; and
 - ii) Communication protocols and interfacing requirements.
- e) For any other activities occurring on or near the track:
- i) Track awareness;
 - ii) Electrified track awareness; and
 - iii) Communication protocols and interfacing requirements.

8.5.3 Engineering Systems Competence

DFCCIL and train operators shall ensure systems are in place for the development and maintenance of employee competence that take into account functions associated with the design, construction, commissioning, monitoring and maintenance, decommissioning and disposal of infrastructure and rolling stock.

8.6 Operations and Safety forms

DFCCIL and train operators shall have in place systems for the management of operations & safety forms to ensure the following:

- a) That there is adequate supply and provision of operations & safety forms, including those carried on locomotives, track vehicles and machines, and those held within control rooms, panels stations, and other locations as appropriate;
- b) That operations & safety forms are correctly completed, submitted, collected and retained, and
- c) That operations & safety forms are retained for a minimum of four weeks. During this period, they shall be made readily available for request by, or exchange between, organisations allowing comparisons with other documents and recordings, for example train graphs and voice recordings. Following this period, the completed forms shall be managed by the organisation in accordance with their own requirements and legislation.

8.7 Safety keys

DFCCIL and train operators shall ensure safety keys are formally issued and withdrawn to or from employees taking into account:

- a) Whether the employee has safety certification, route and yard competence;
- b) Whether the employee requires the safety keys to carry out rail safety work, and
- c) The requirement to withdraw the keys upon the employee's termination or completion of employment.

B. Rolling Stock Requirements

8.8 Train Braking Requirements

Train operators shall establish systems and manage all requirements associated with train braking including, but not limited to ensuring that:

- The train brake applies to the train characteristics and DFC network area;
- Brakes are repaired or vehicles remarshaled or detached and brakes cut out as detailed below

- All IR trains must have a valid brake power certificate to operate on the DFC network. Under normal circumstances the brake power should not become invalid while on transit over DFC. In case of any lapses in Brake Power certificates, DFCCIL shall not be tasked or responsible in any manner whatsoever, in restoring the same and this shall be sole responsibility of IR
- All private operators must have internal controls and provisions into their respective safety management systems to ensure that all trains have valid brake power certification (internal or through external agency) in line with requirements of DFCCIL and its various agreements with the operator. Such certification must be valid at all times during train's passage through DFC Network unless it is involved in long haul formation. For long haul formation, instructions will be issued by DFCCIL which will also cover the issue of valid BPC. In case of any lapses in Brake Power certificates, DFCCIL shall not be tasked or responsible in any manner whatsoever, in restoring the same and this shall be sole responsibility of the operator

DFCCIL and Train Operators shall be responsible for ensuring compliance with the following:

- a) Instructions issued by IR for
 - i) allowing isolated vehicles,
 - ii) Coupling of unbraked vehicles and
 - iii) identification of wagons with isolated brakes should be followed by Train Operators.

C. Locomotive requirements

8.9 Locomotive Pilot Competency

- a) Train operators and DFCCIL shall ensure that Locomotive Pilots are competent in the following:
 - i) DFCCIL General Rules and Procedures;
 - ii) Interface arrangements for network entry and exit, and associated documentation; and
 - iii) The processes of the operations manual.
- b) To be in control of a train on the DFC network, the Locomotive Pilots shall be competent in operational and practical requirements relating to the following:
 - i) Train preparation, testing and management;
 - ii) Locomotives and rolling stock types to be operated; and
 - iii) Route and infrastructure knowledge, including yards and other facilities, for the areas over which the Locomotive Pilot is required to operate.

8.10 Locomotive Equipment

- a) When operating on the DFC network, Locomotive Pilots shall ensure the following equipment is provided and is in good working order:
 - i) A watch or clock;
 - ii) Approved personal safety equipment;
 - iii) Locomotive communications equipment for on train and off train communications;
 - iv) Operational End of Train Telemetry Equipment where a guard is not on the train;
 - v) Safe working keys;
 - vi) Forms required as per DFCCIL General Rules and other circulars.
 - vii) Emergency Equipment as prescribed
 - viii) First aid supplies as prescribed.
 - ix) For operation during foggy weather
- b) Prior to allowing a train to enter the DFC network, Locomotive Pilot shall ensure that:

- i) All necessary air brake tests have been performed and are within required limits;
 - ii) Locomotive headlights are tested on high and low beam and, and where fitted, 'ditch lights' are checked and are fully operational;
 - iii) Where fitted, locomotive identification lights are fully operational;
 - iv) The locomotive whistle/horn is fully operational;
 - v) Where a guard is not on the train, the End of Train Telemetry is operational, and
 - vi) The locomotive communications equipment is fully operational.
 - vii) Sanders and wipers are in working condition.
 - viii) No safety equipment is in bypass condition
 - ix) Locomotive pantograph is fit for high rise OHE if required to operate on WDFC.
- c) The Locomotive Pilot shall ensure that a locomotive, when attached to another locomotive or to a train, is securely and correctly coupled.
 - d) When preparing locomotives, the Locomotive Pilot shall enter details as required into the data logger or similar device or facility, if provided, on each locomotive before working the train. At subsequent crew changes, the details shall be entered on the leading locomotive only;
 - e) Should the train have an operating locomotive midway of the train consist, and it is required to assist with hauling the train, the driver shall ensure that the remote operating equipment such as Locotrol for the locomotive is tested and operational;
 - f) A Locomotive Pilot shall not render inoperative any device provided for the safe operation of the locomotive unless authorised and appropriate instructions accompany the action, and
 - g) If the vigilance control system becomes defective, and it becomes necessary for the Locomotive Pilot to isolate the device, the matter shall be reported in accordance with train operator's instructions. In all instances the DFCCIL train controller shall be advised.

8.11 Locomotive Speedometer

- a) Prior to entering the DFC network, or as soon as practicable the Locomotive Pilot shall ensure that the locomotive speedometer is working;
- b) In case of speedometer failure during the run, the DFCCIL train controller and Locomotive Controller shall be advised and the Locomotive Pilot shall measure train speed as detailed in the DFCCIL General & Subsidiary Rules and Procedures.

8.12 Locomotive Pilot Vigilance

Locomotive Pilots operating trains on the DFC network shall observe the following:

- a) Be alert and observe the track in the direction in which the movement is being made;
- b) Not engage in any activity on the locomotive that distracts attention to safety;
- c) Start and stop the train carefully, control slack action, and pay attention to the weather and track conditions as well as the length and mass of the train;
- d) Regulate the running of the train as accurately as possible to avoid loss of time;
- e) Not exceed speed limits;
- f) Be alert and prepared to stop or reduce train speed;
- g) Obey each speed restriction imposed, or in accordance with the condition of the track as noticed by the Locomotive Pilots themselves;
- h) When approaching a station, siding, signals or a level crossing, keep a sharp look out, particularly when weather is not clear or visibility is impaired for any reason;
- i) Keep a sharp look out for track workers or other persons, track vehicles or machines on or near the track;
- j) When starting and accelerating, and at frequent intervals during the journey, look back to see that the whole train is following in a safe and proper manner.

- k) Keep a sharp look out for flooding or fires by the side of the track, or on adjacent land or property;
- l) Report incidents including inclement weather hampering visibility to the DFCCIL train controller;
- m) Work as directed by the DFCCIL train controller, SM or ASM, and
- n) Not be absent from the Locomotive Pilot position in the locomotive cabin.

8.13 Locomotive Whistle Operation

8.13.1 Normal use of locomotive Whistle

- a) Locomotive Pilots shall sound the locomotive whistle clearly and distinctly;
- b) The intensity, length and repetition shall be as per G&SR;
- c) The Locomotive Pilot shall sound the locomotive whistle in the following situations:
 - i) Before moving a locomotive from stop and, as far as practicable, having seen that no person is in a position of danger;
 - ii) When approaching and passing another train;
 - iii) When shunting is being performed;
 - iv) When approaching workers on or near the track on which the train is operating;
 - v) When approaching level crossings, bridges and tunnels;
 - vi) When indicated by whistle signs situated at the track side; and
 - vii) When operating a work train with workers riding or working in or near rolling stock, before starting or reducing speed.
- d) The Locomotive Pilot shall not sound the locomotive whistle without a valid reason to do so.

8.13.2 Locomotive Whistle failure

- a) If the locomotive whistle fails at any time on the DFC network, the Locomotive Pilot shall report to the DFCCIL train controller and locomotive controller and operate the train as directed by the DFCCIL train controller.

The Driver must:

- i) Attempt to repair the fault;
- ii) Change the locomotive in consultation with train controller ; or

Arrange for the fault to be repaired by the train operator's maintainer.

- b) If it is not possible to carry out repairs, the following shall apply:
 - i) The Locomotive Pilot may continue at normal speed while conditions are clear, and there is sufficient view from the driving position to ensure there are no road vehicles, workers, pedestrians or livestock in the vicinity of the track;
 - ii) If conditions are not clear or there is insufficient view from the driving position to ensure there are no road vehicles, workers, pedestrians or livestock in the vicinity of the track, the Locomotive Pilot shall reduce speed.
 - iii) The Locomotive Pilot shall operate the headlight between low and high beam to attract attention when approaching:
 - a level crossing;
 - a person or people walking or working on or near the track; or
 - any other location where the Locomotive Pilots considers it necessary; and
 - iv) If the Locomotive Pilot considers that occupants of vehicles or persons walking or working on or near the track have not become aware of the approach of the train the Locomotive Pilot shall:

- Attempt to stop the train; and
 - Remain stationary until any danger of an accident has passed.
- c) When approaching level crossings not equipped with automatic warning devices or gate keepers and the locomotive whistle is inoperative, the Locomotive Pilot shall:
- i) Approach the level crossing at a speed that will enable the train to stop safely and avoid collisions with road vehicles, workers or pedestrians;
 - ii) Stop before the level crossing;
 - iii) Obey the signal of a DFCCIL/ Railway Servant or one of the Locomotive Pilots who shall go ahead to the level crossing and signal the Locomotive Pilot when the level crossing is clear, and all road and pedestrian traffic has stopped or is clear of the level crossing; and
 - iv) Proceed across the level crossing at cautious Speed.

8.14 Locomotive Headlight Operation

8.14.1 General

These procedures must be read in conjunction with the DFCCIL General Rules and Procedures.

8.14.2 Normal Use of Locomotive Headlight

- a) The Locomotive Pilot shall ensure that the headlight is on at all times during night time or when visibility is impaired, in the full position, whenever the train is moving on the running lines, except as set out in Items (c), (d) and (e) below;
- b) The Locomotive Pilot shall ensure that the headlight is turned off when the train is waiting to cross another train. However, the headlight shall only be turned off after the train has been confirmed as standing in clear and the points have been set to protect the train;
- c) The Locomotive Pilot of an over-length train shall dim, but not turn off the headlight, when:
 - i) The train is authorized to enter a station;
 - ii) The train is waiting to cross another train, and
 - iii) The train has stopped; it is not in clear of the clearance point (due to it being over length) at a station.
- d) The Locomotive Pilot of the over length train shall only turn the headlight off when:
 - i) The Locomotive Pilot establishes voice communications with the Locomotive Pilot of the approaching train, before it arrives, and
 - ii) The conditions of entry are clearly established so that the train can be stopped before the points.
- e) The Locomotive Pilot shall dim the headlight or if “marker” or “Flasher”, lights are fitted, switch off the headlight when:
 - i) Passing through locations where shunting is occurring;
 - ii) Standing close behind another train;
 - iii) Approaching junctions, terminals or stations;
 - iv) IV. Approaching locations where the train is to stop;
 - v) When motor vehicles are approaching (on nearby roads) from the opposite direction, and
 - vi) Approaching a train operating in the opposite direction on a parallel track.
- f) The marker” or “Flasher” lights fitted to the leading locomotive, they shall be left on in each of the circumstances described in Items (c), (d) and (e).

8.14.3 Locomotive Headlight Failure

- a) If the locomotive headlight fails at any time on the DFC network, the Locomotive Pilot shall report to the DFCCIL train controller and locomotive controller.
- b) One of the following alternatives, whichever is the most practical in the circumstance, shall be carried out if possible:
 - i) Repair the fault;
 - ii) Change the locomotive in consultation with Train controller; or
 - iii) Arrange for a maintenance worker to remedy the defect.

If it is not possible to carry out any of these alternatives to enable headlight, ‘marker” or “Flasher”, lights to be displayed, the driver shall proceed as detailed in the DFCCIL General Rules and Procedures.

8.15 Locomotive Pilots verifying Authorities and other Information

When approaching signals, point indications, speed signs or other trackside signs the Locomotive Pilot at the controls of the locomotive shall obey its meaning, and if there is more than one Locomotive Pilot on the locomotive, both Locomotive Pilots shall confirm and verbally call the meaning of the signal to the other Locomotive Pilot, and ensure that the Locomotive Pilot is controlling the train in accordance with the signals meaning.

8.16 Signal Passed at Danger

8.16.1 Signal Failure

Should a train or locomotive pass a signal displaying stop, the driver shall immediately stop the train report the event to the DFCCIL train controller and advise the reason the train has passed the signal.

If the signal has reverted to stop as the train was approaching, the DFCCIL train controller shall contact the DFCCIL SM or ASM at the station and establish the cause for the signalling restoring to stop and if established that a signal fault has occurred, authorise the train as detailed in the DFCCIL General Rules and Procedures.

The DFCCIL train controller shall advise the S&T Controller of the event and make arrangements for the signal fault to be rectified. DFCCIL shall also initiate an investigation and submit outcomes to the appropriate authority.

8.16.2 Locomotive Pilot Error

If it is found that the Locomotive Pilot has allowed the train to pass the signal at stop in error, the DFCCIL train controller shall not allow the train to be moved by the Locomotive Pilot and arrangements shall be made the Locomotive Pilot relieved.

If there is requirement to move the train owing to safety reasons, the assisting driver may be permitted to move the train into a safe position but only as directed by the DFCCIL train controller and the SM or ASM at the station.

DFCCIL will be responsible for investigating the reason for the train passing the signal at stop and providing outcomes, recommendations and corrective actions to DFCCIL

8.17 Trains Unexpectedly Stopping on the Main Line

Should there be requirement for the driver to stop a train in between stations owing to an abnormal event, such as locomotive failure or loss of train brake pressure, the driver shall immediately communicate with the DFCCIL train control and provide details.

If the Locomotive Pilot considers that the train may be obstructing parallel lines, the Locomotive Pilot shall broadcast warnings on the train radio, emergency call in an attempt to stop other trains approaching.

The Locomotive Pilot shall endeavour to put in place protection methods to protect the stationary train if required.

If the stationary train is not obstructing parallel lines, the Locomotive Pilot shall exercise caution when leaving the locomotive to resolve the issue and once resolved, again communicate with the DFCCIL train controller prior to allowing the train to continue.

8.18 Locomotive Pilot Fatigue or other Incapacity

A Locomotive Pilot shall not commence or continue to operate a train if their ability to operate the train safely is impaired due to incapacity

- a) for example through illness, injury or duty over hours;
- b) Where incapacity has occurred after the commencement of duty, the Locomotive Pilot shall:
 - i) Stop the train at the next station and advise the DFCCIL train controller of the circumstances;
 - ii) Not proceed until their capacity to manage the train safely is restored or another Locomotive Pilot is provided, and
 - iii) At the completion of duty, the Locomotive Pilot shall complete a report detailing the circumstances of the incapacity and submit it to DFCCIL

D. Safety

8.19 Safety Performance

8.19.1 Compliance Monitoring

DFCCIL and train operators shall monitor operational safeworking activities and engineering systems safety that take into account:

- a) The conducting of formal internal audits of procedural systems and physical assets within appropriate intervals;
- b) The regular observation of employees undertaking activities on the job;
- c) The initiation of corrective action where there is evidence of non-compliance;
- d) The prompt exchange of information between affected organisations when serious non-compliance is detected, and
- e) The maintenance of safety compliance monitoring records.

8.19.2 Performance Review

DFCCIL and train operators shall review safety performance including incident data, reports and recommendations.

Problems identified during safety performance reviews shall be subject to appropriate corrective action and post review to ensure their effectiveness.

DFCCIL and train operators shall implement and participate in joint safety performance review meetings where incidents require corrective actions that may affect more than one organisation.

E. Other Requirements

8.20 Train Documentation and other Instructions

DFCCIL and Train operators shall ensure that Locomotive Pilots are provided with relevant documentation, circulars and other advices applicable to the DFC network.

- a) Before commencing duty or as frequently as necessary, familiarise themselves with any notices and instructions relevant to their working on the DFC network;
- b) During duty be in possession of, and familiar with, all train documents that are required for their train which may include the following:
 - i) Certificate associated with train integrity;
 - ii) Train consist details;
 - iii) Safe working documentation;
 - iv) Speed restriction information;
 - v) Dangerous goods documentation; and
 - vi) Other documents applicable to the operation of the train on the DFC network.
- c) At the completion of duty
 - i) If the Locomotive Pilot changes over with another Locomotive Pilot, , give the information to the other Locomotive Pilot that is to take over the responsibility for the train; and
 - ii) At the final destination, provide the documents to the train operators appointed employee for its collection, or place it in the location provided for the purpose, as appropriate.

8.21 Track Access Agreements

Access agreements negotiated between DFCCIL and a train operator shall specify the terms and conditions of access to the DFCCIL network. Reference shall be made to the functional parameters agreed through the implementation of the ICP.

Access agreements should identify the process for:

- a) Proposed timetable for trains to have access to the DFC network, and
 - b) Class of each train including its operational performance restrictions and limits.
- DFCCIL and the train operator shall maintain appropriate accreditation before the train service commences.

8.22 Infrastructure and Rolling Stock Restrictions

DFCCIL and train operators shall implement systems to manage restriction information, including the following:

- a) Permanent speed restrictions imposed (e.g. due to track curvature, gradient or signal sighting);
- b) Temporary speed restrictions imposed (e.g. due to infrastructure condition);
- c) Other warnings and restrictions (e.g. loading, clearances, those to compensate for the effects of weather and other natural occurrences), and
- d) Means of communicating the restrictions such as the following:
 - i) Track side sign boards to identify speed restrictions;
 - ii) The regular issue of restriction information; and
 - iii) Advice to Locomotive Pilots of details of new restrictions that may be imposed between regular issues of restriction information by the network. This information should be provided as soon as practicable such as not to jeopardize safety, and detail whether trackside signs have been installed.

Train operators shall ensure Locomotive Pilots are issued with current restrictions, warnings and other important notices issued by DFCCIL.

8.23 Train Identification Numbering

Train Identification Numbers will be allocated, updated and maintained by DFCCIL and provided to train operators.

Locomotive Pilots, when communicating with the DFCCIL train controller must utilise the train number as the source of identification

8.24 Length of Trains

The maximum length that a train shall operate on the DFC network is 750 meters Single haul train & 1500 metres long-haul train.

Train operators shall provide an effective means of accurately determining the length of a train (including locomotives), and the length of a train shall not exceed the specified maximum length for any portion of the train's transit.

For long trains, allowance should be made for 'train slack' when determining train length.

The train length is specified in the Access Agreement for that particular train over the corridors of operation and may be equal to or less than the network infrastructure limits.

8.25 Access to the DFC Network

8.25.1 Overview

Train operators shall ensure that trains requiring to access the DFC network are correctly marshalled and ready to enter expeditiously.

The train operator shall ensure that all train marshalling activities, including the detaching and attaching of locomotives, brake vans, combining or splitting of trains occur prior to entry to the DFC network.

8.25.2 Shunting on the DFC

When a train requires to shunt on the DFC after network entry, including the detachment or attachment of locomotives, brake vans or the combination or splitting of trains, this may only be performed provided it has been included in the train plan for the train.

Any activities that are not planned may only be undertaken provided the DFCCIL train controller authorises the shunting activities and then only provided the shunting activities will not have impacts on other trains operating on the DFC.

8.26 Incidents and Notifiable Occurrences

Operations and safe working incidents shall be reported in accordance with the requirements of the ICP.

Each organisation should maintain contact details of the person(s) within their organisation responsible for receiving the information regarding incidents. These details should be provided to other organisations party to the ICP.

Each organisation should determine if the incident is a notifiable occurrence and undertake the requirements of their organisation.

Each organisation should maintain their own records of incidents and corrective actions that are planned or implemented.

8.27 Major Emergency Response Plan

DFCCIL and train operators shall maintain an Emergency Response Plan.

The purpose of the Emergency Response Plan is to provide direction to DFCCIL/Railway personnel in the coordination and mobilisation of resources in the event of a major emergency necessitating urgent medical or emergency aid.

The Emergency Response Plan shall remain in effect at the site of the major emergency until police or other command authority hand the site back to the DFCCIL/Railway organisation(s) and declare the area safe for recovery purposes.

The Emergency Response Plan shall define the following:

- a) Geographic scope to which it applies;
- b) Distribution list;
- c) Point of contact in the DFCCIL/Railway organisation(s);
- d) Identification of resources able to render assistance in the event of a major emergency;
- e) Procedures for emergency access to the infrastructure including site access to the track and special requirements in electrified areas;
- f) Communication requirements including the following:
 - i) Contact details and communication protocols during the emergency for Emergency Services and key railway personnel;
 - ii) Requirements for immediately informing the emergency services or controlling authority of the situation via a situation report containing information in a format consistent with Emergency Services requirements;
 - iii) Requirements for ongoing situation reports to be also provided to the emergency services controlling authority and railway organisation representatives, and
 - iv) Procedures for ensuring the maintenance of constant communication with, and at the emergency site and keeping the site informed of the progress of the emergency services Response.
- g) Responsibilities of DFCCIL/Railway servants during a major emergency including:
 - i) Initial survey by on-site personnel of the scene of the major emergency with the aim of preventing further casualties from secondary effects. This will ordinarily take precedence over first aid and evacuation of the injured and should be carried out without creating danger to the personnel involved;
 - ii) Initial response requirements of personnel following advice of a major emergency, be it from a railway worker, other authority, or member of the public;
 - iii) Site control both prior to and following arrival of emergency services;
 - iv) The duty of workers to comply with the directions of the controlling emergency authority and provide every assistance possible in response to those directions; and
 - v) Control of train and other movements impacted by or required to assist in the major emergency.
- h) Evacuation procedures for workers, passenger and the public;
 - i) Dangerous goods requirements, and or
 - ii) Requirements for responding to media inquiries.

8.28 Fire on Train

When any vehicle or freight on a train is on fire, as far as practicable, the Locomotive Pilot must stop the train in a position where the Locomotive Pilot and guard (where provide) can attend to their own safety and that of any other persons on the locomotive, or on the train, and determine the extent of the fire and if dangerous goods are involved.

The Locomotive Pilot shall:

- a) Immediately advise the DFCCIL train controller, in order to institute the appropriate Emergency Response Plan and Emergency Procedures for the train and for the location (e.g. electrified territory);
- b) Alert neighbouring trains on the Emergency Call;
- c) Ensure that parallel lines are protected against rail traffic;
- d) Determine if the fire can be dealt with on the spot using on-train emergency response procedures and the equipment provided on the train for the purpose;
- e) If the burning vehicle(s) carry freight, determine if they should be isolated from the remainder of the train and not moved again until the danger has passed;

- f) Consult with the DFCCIL train controller to determine if the train should continue with burning freight vehicle(s) to a convenient location where they can be dealt with or be detached.

If the freight vehicle(s) where the fire has occurred are to be isolated from the remainder of the train, the Locomotive Pilot shall:

- i) Secure the portion of train behind the fire and uncouple that portion of the train;
- ii) Pull the front portion with the burning vehicle(s) forward and clear of the secured rear portion; and
- iii) Uncouple the burning vehicles(s) and pull forward once again to isolate that portion.

The Locomotive Pilot shall remain in constant communication with DFCCIL train controller to:

- i) Seek assistance as required;
- ii) Report actions that have been taken; and
- iii) Arrange recovery, track clearance and whatever is required for the resumption of normal operations.

8.29 Guard or Brake Van on Train

8.29.1 Overview

All trains running on DFC are required to have a functional End of Train Telemetry (EOTT) fitted and work without guards. In extraordinary circumstance, with prior permission of DFCCIL control, Trains without EOTT may operate on the DFC with a guard in a brake van, without a guard in a brake van or with no brake van attached to the rear of the train.

8.29.2 Train with Guard in Brake Van

For a train operating on the DFC network with a guard in the brake van without End of Train Telemetry attached to the rear of the train, the guard shall remain in communication with the Locomotive Pilot confirming the train's integrity at each station or in accordance with the train operators operating requirements.

8.29.3 Train with No Guard in Brake Van

When a train requires to operate on the DFC network with no guard in the brake van, the train operator must ensure that an operational End of Train Integrity device is attached to the rear of the train reporting end of train details to the Locomotive Pilot in the locomotive of the train.

The train operator shall also ensure that the brake van is secure and all access doors are locked to prevent unauthorised entry to the brake van.

8.29.4 Train with No Brake Van

When a train requires to operate on the DFC network with no brake van, the train operator must ensure that an operational End of Train Telemetry device is attached to the rear of the train reporting end of train details to the Locomotive Pilot in the locomotive of the train.

8.29.5 Changes While in Transit on the DFC

Permission of DFCCIL train controller must be taken of any changes, such as the guard disembarking the train and being replaced with End of Train Integrity equipment during the trains journey on the DFC which shall include the provision of an updated train consist being issued to the DFCCIL train controller. No changes in transit will be permitted without prior permission of DFCCIL Train controller.

8.30 Locomotive De-Sanding Equipment

Train operators shall allocate locomotives with functioning sanding and where available, de-sanding equipment.

Sanding equipment on locomotives may affect the integrity of the signalling system in track circuited areas.

In track circuited area where locomotives do not have desanding equipment, the Locomotive Pilot must limit the application of sand where practicable.

8.31 On Train Communication

Train operators are responsible for the provision of locomotive based communication equipment required for network operations and safeworking.

The train operator shall ensure that locomotive communications equipment as prescribed by DFCCIL is provided, maintained and is compatible with the equipment used by DFCCIL train control. Train operators may request radio frequencies directly from DFCCIL.

8.32 Locomotive Pilot Allocation

DFCCIL or Train Operators shall establish systems and manage all requirements associated with providing crew for working of trains.

The systems established shall ensure that:

- a) Locomotive Pilots are medically fit and capable of undertaking their duties;
- b) Locomotive Pilots are certified and have current competency in relevant route knowledge, train handling and safeworking rules and procedures;
- c) Locomotive Pilots are competent in the operational and practical requirements relating to train preparation, testing and management for the types of locomotives and rolling stock to be operated;
- d) Locomotive Pilots are not overhours and have sufficient working hours left from their sign on time to perform the crew run assigned to them. Loco pilots who do not comply with zero drug and alcohol requirements, are not permitted to operate trains.

Before a train enters the DFC network, advice shall be provided to the DFCCIL train controller about any planned Locomotive Pilots change requirements that may affect the train's path.

After entering the network, Locomotive Pilots should continue to communicate with the DFCCIL train controller about changing Locomotive Pilots in transit so that path of trains is not unduly affected.

Locomotive Pilot changes should not be planned to take place part way through any section.

Where a train is comprised of more than one crewed locomotive, the Locomotive Pilots shall have effective radio communications with each other and the loco pilot of the leading locomotive shall have full control of train braking.

8.33 Combining Trains with LOCOTROL

A joint procedure order may require to be issued by MOR for running long haul trains using Locotrol.

9. Wayside Monitoring Devices

9.1 Device in Use

Wayside monitoring devices are installed on the DFC network to provide a variety of performance statistics and where necessary, operational alarms within the DFCCIL Train Control centre.

9.2 Table: Wayside Monitoring Devices

Device	Description
HBD	Hot Box Detector: Devices that measure the temperature of wheel bearings as the wheels pass over the device.
ABD	Acoustic Bearing Detector: Devices used to monitor trending of rail wheel bearing faults.
HWD	Hot Wheel Detector: Devices used to detect sticking or defective brakes.
WILD	Wheel Impact Load Detector: Devices used to measure the impact on the rail surface caused by wheel tread defects.

9.3 Response to Alarms

- a) Alarms from Wayside Monitoring devices will be received by the DFCCIL train controller.
- b) Upon receiving an alarm, the DFCCIL train controller shall contact the Locomotive Pilot of the train triggering the alarm and advise the Locomotive Pilot of the circumstances.
- c) The DFCCIL Train Controller shall also advise the DFCCIL Station Master or Assistant Station Master at the next station of the circumstances.
- d) The Locomotive Pilot shall bring the train to a stand and arrange for the train to be inspected for any faults associated with the alarm.
- e) Should the train stop between stations, the DFCCIL train controller shall contact other trains on the DFC in the area and advise the Locomotive Pilots to approach the stationary train cautiously.
- f) The Locomotive Pilot shall relay outcomes of the train inspection to the control who shall arrange to advise the train operator and establish if the train can resume its journey, be moved to the next station for the affected vehicle to be detached, or not be moved pending further inspection or repairs.
- g) If the vehicle requires to be repaired at its current location the train operator shall advise the requirements for the repair activities including any requirements to isolate parallel lines and/or the overhead power equipment.
- h) The DFCCIL Train Controller and/or DFCCIL Traction Controller shall put in place processes and arrange for DFCCIL management to attend the scene and ensure the site is safe for the repairs to occur.

10. Rolling Stock operating on DFC Network

10.1 Registration and Warranty

Details of Rolling stock (including locomotives) requiring to operate on the DFC network shall be provided by the Operator to DFCCIL.

DFC Locomotive Controller and Wagon Controller shall keep the rolling stock information provided by Operator for ready use whenever required.

When new rolling stock is added to a fleet, or if rolling stock operational or engineering characteristics are modified, the train operator shall provide DFCCIL with the information that the rolling stock complies with the train operators Access Agreement.

Locomotive and rolling stock data to be provided by the train operator to DFCCIL shall include:

- a) Automatic equipment identification (if provided) ;
- b) Maximum axle loading (tonnes/axle);
- c) Maximum speed (empty);
- d) Maximum speed (loaded);
- e) Number of axles;
- f) Tare weight (tonnes);
- g) Tractive horsepower (locomotive);
- h) Length over couplers;
- i) Unique vehicle description (class and number), and
- j) Rolling stock type (e.g. freight type, freight hopper, locomotive type).

Train operators shall establish systems and manage all requirements associated with managing their registered rolling stock fleet, whether leased or owned, to ensure only rolling stock that is fit for use on the DFC network is allocated for access to any or all of the DFC network.

10.2 Wheel Profiles

Train operators shall establish systems and manage all requirements associated with ensuring compatible wheel profiles are used on the DFC network.

Rolling stock with incorrect wheel profiles may continue to be used provided re-profiling to the correct standard is scheduled as part of a regular rolling stock maintenance program.

11. Train Diversions

Owing to network disruption, DFCCIL may be required to divert rail services of the DFC network and onto the IR network provided the IR network can accept the increase in rail traffic.

When there is a requirement to divert rail traffic, the DFCCIL train controller shall liaise with the IR train controller and come to an agreement on the process and timing that will allow the rail traffic to be diverted onto the IR network and then back onto the DFC network at the next unaffected junction station.

The DFCCIL train controller shall also liaise with the train operators and ensure that the train is able to be diverted ensuring that the Locomotive Pilot has appropriate competencies and route knowledge to operate on the IR network, and the train meets the operating requirements of IR such as axle load and Maximum Moving Dimensions (MMD) permitted.

12. Safe working Operations

12.1 Rule books

DFCCIL is responsible for the management and distribution of the DFCCIL General Rules and Procedures to train operators and other employees performing safety related activities.

Train operators are responsible for obtaining the DFCCIL General Rules and Procedures, and ensuring that all employees requiring to perform safety related task on the DFC are issued a copy for their own personal use.

12.2 Safe working Forms and Safety Equipment

Train operators shall establish systems and manage the supply, maintenance and provision of safe working forms and safety equipment for use by employees. This includes, but is not limited to safe working forms and safety equipment:

- a) Issued directly to employees, and
- b) Provided on locomotives, rolling stock or track maintenance vehicles for their use.

Systems established by DFCCIL, Operators and Maintainers for safeworking forms shall include, but not be limited to:

- a) Supply and provision;
- b) Collection and internal audit;
- c) Retention for a minimum of four weeks for access by DFCCIL where there has been an incident, and
- d) Archiving within the organisation (as per Appendix B)

Safety equipment includes but is not limited to:

- a) Watches and clocks;
- b) Safe working keys;
- c) Radios and telephones (fixed or mobile);
- d) End of train monitors and markers;
- e) Emergency equipment for train protection including sufficient detonators / audible warning devices, red and green flags, hand lamps and torches, and
- f) Personal protective equipment for normal and emergency use for all conditions of the Network.

Systems established by DFCCIL, Operators and Maintainers for safety equipment shall include, but not be limited to:

- a) Security for issue, storage and withdrawal from rail safety workers;
- b) Provision and security of fixed equipment on locomotives, rolling stock or track maintenance;
- c) Vehicles for the use of rail safety workers, and
- d) Internal records and audit.

DFCCIL shall ensure safe working keys are available to train operators and maintainers at their cost to enable access to safe working equipment for operations. Accredited Operators may request details about the types of safe working keys required directly from DFCCIL.

12.3 Time

All operations on the DFC network operate on 24 hour time.

13. Train Service Planning

13.1 General Requirements

Train operators shall establish systems and manage all requirements associated with train service planning including building and operating trains within the requirements of DFCCIL for the train path for each train in respect of:

- a) Any planned shunting en route and their effect on train parameters;
- b) Axle load maximum, for locomotives and rolling stock;
- c) Braking requirements including testing;
- d) Dangerous goods;
- e) Rolling stock (including locomotives) allocation;
- f) Train compatibility for possible train diversions;
- g) Diversion arrangements;
- h) Train documentation;
- i) Train height, width and length limits;
- j) Train loading and security;
- k) Train marshalling requirements (including for locomotives marshalled together);
- l) Train schedule adherence (sectional running times);
- m) Train speed maximums, and or
- n) Train amalgamations as part of a normal train service.

Operators shall conduct train operations to meet the terms and conditions of DFCCIL and legislative requirements.

13.2 Locomotive Allocation

Train operators shall establish systems and manage all requirements associated with locomotive allocation and the support of locomotives.

When allocating locomotive, train operators require to take into consideration the potential differences between the eastern corridor and the western Corridor, and ensure that locomotive operating on the western corridor are suitably equipped to operate under the higher overhead equipment designed for double stacking.

Allocation of locomotives shall include but not be limited to locomotives:

- a) Rated for the track speed and capable of meeting the schedule to which the train is allocated;
- b) Fit for use on the DFC network in terms of:
 - i) multiple unit compatibility;
 - ii) mechanical and electrical condition, and
 - iii) the task to be performed.
- c) Provisioned with sufficient supplies of fuel, sand, coolant lubricants;
- d) Safe working and communications equipment, and
- e) Managed for train integrity when attached dead or offline.

Operators shall provide the DFCCIL locomotive controller with:

- a) Advice of locomotive allocations at least three hours prior to the service commencing use of the DFC network, and
- b) Timely advice of subsequent changes due to operational reasons.

13.3 Train Speed Capacity

Train Operators shall establish systems and manage all requirements associated with ensuring the train consist is comprised of locomotives and vehicles rated and loaded to travel at the speeds required in the train schedule.

The speed of any train must not exceed the maximum permissible speed, whichever is lowest, of:

- a) The speed specified for the train schedule type;
- b) Load Limits for DFC network;
- c) The lowest maximum speed rating for any locomotive or vehicle in the train consist;
- d) Permanent or temporary speed signs displayed trackside;
- e) The speed needed to comply with signal indications, or
- f) Temporary speed restrictions notified by network control.

13.4 Train Hauling and Holding Capacity

Train operators shall establish systems and manage all requirements associated with train hauling and holding capacity by individual and multiple locomotives in any combination or arrangement. This shall include, but not be limited to:

- a) Managing the allocation of rolling stock (including locomotives);
- b) Train hauling capacity to maintain the train schedule running, and or
- c) Train holding capacity when stationary on all conditions and grades for the intended journey.

14. Rolling Stock Outlines and Load Restrictions

14.1 Overview

Train operators shall establish systems and manage all requirements associated with compliance to DFCCIL network rolling stock outlines and load restrictions.

14.2 Maximum Wagon/Loading Dimensions

Figure: 14.2.1 - Maximum Moving Dimensions – Eastern Corridor (in mm)

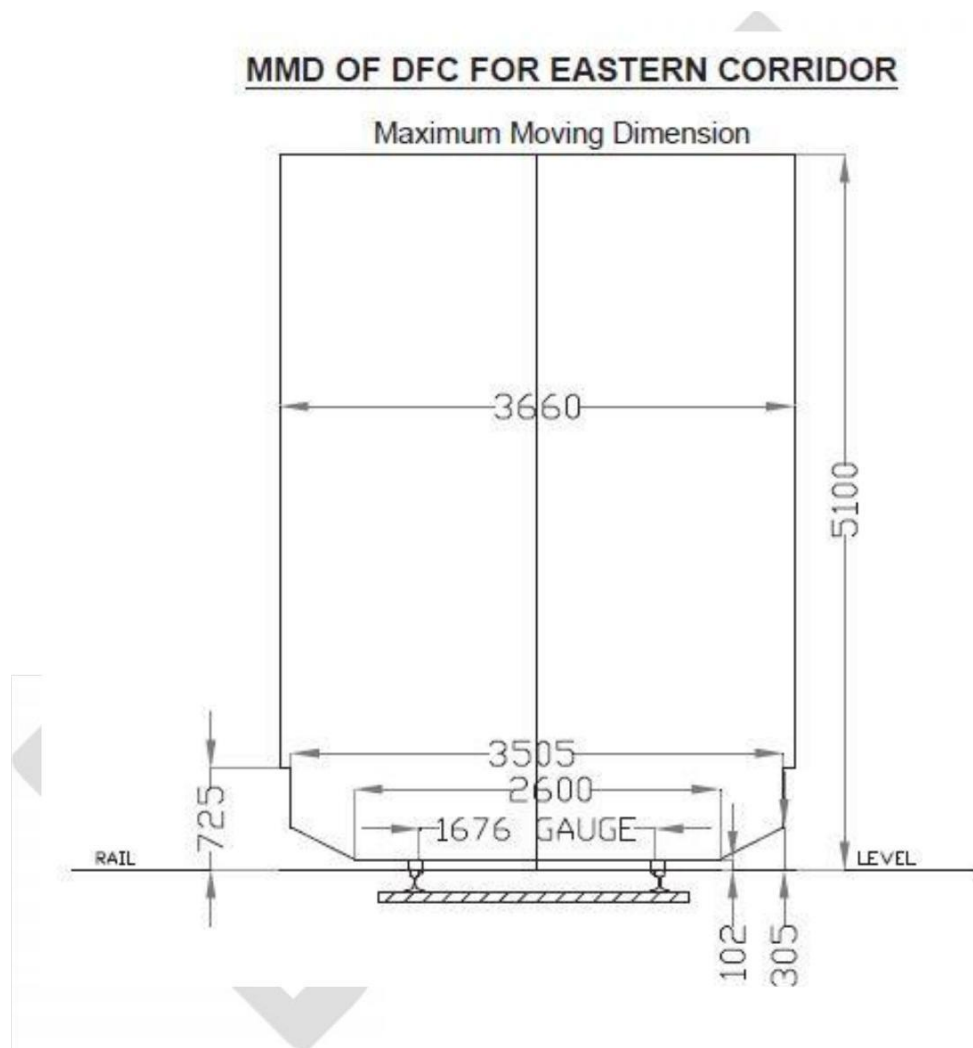
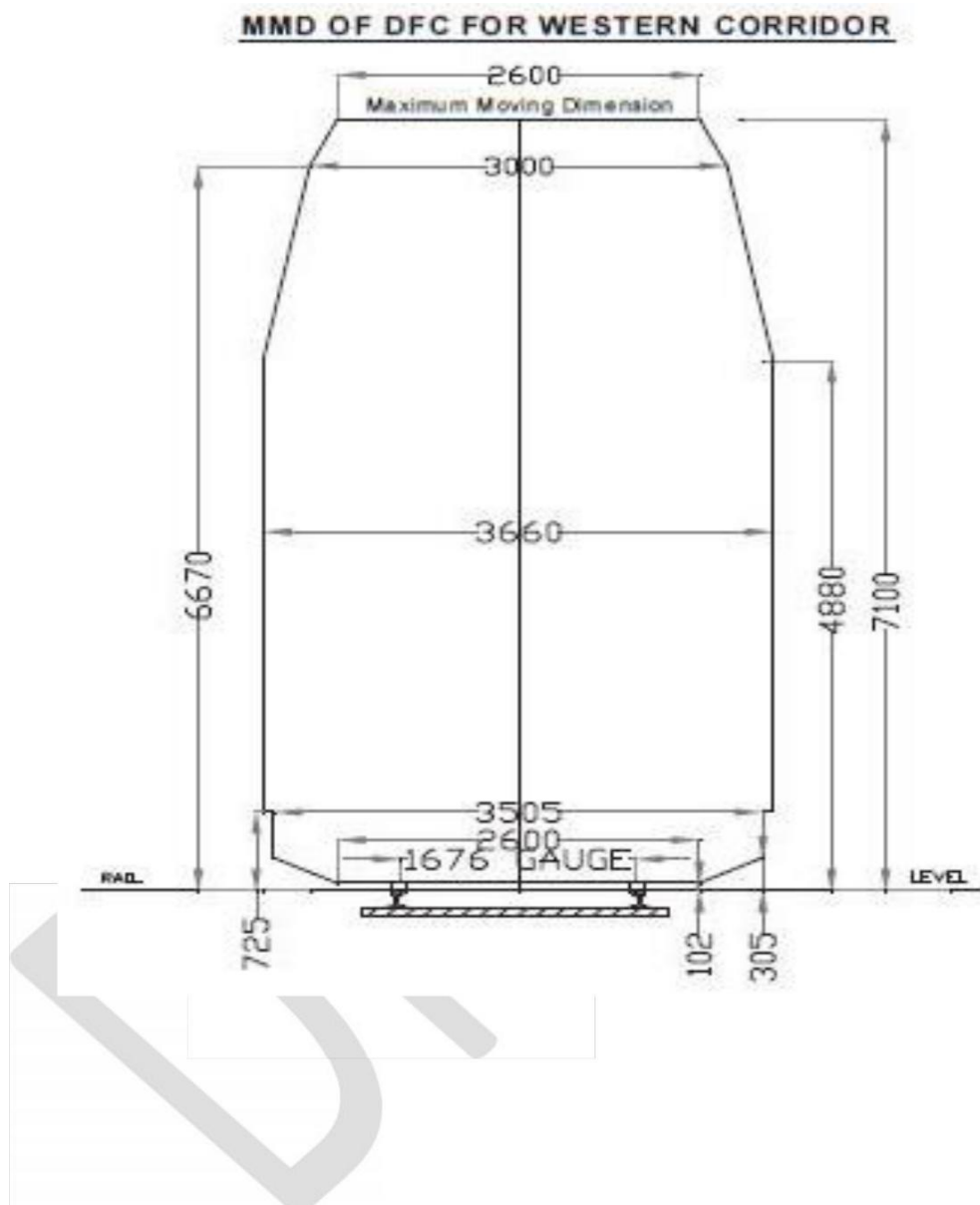

Figure 14.2.2 - Maximum Moving Dimensions – Western Corridor (in mm)



- a) Any loading exceeding the dimensions shown in Figures 17-1 and 17-2 are classified as out of gauge and may only be conveyed under special conditions as determined by DFCCIL.
- b) Loading outlines include lashings, chains and securing equipment.

14.3 Maximum Axle Load

- a) The maximum permissible axle load on the DFCCIL network shall be 25 tonnes unless otherwise notified by DFCCIL.
- b) Any loading exceeding the permissible maximum axle load may only be conveyed under special conditions as determined by DFCCIL.

14.4 Other Loading Requirements

Following are additional loading requirements that apply on the DFC network:

- a) Train operators shall construct trains of vehicles loaded without exceeding applicable:
 - i) Axle load limits taking into account weight distribution, or
 - ii) Train height and width maximums.
- b) Loading shall be secured to prevent movement during transit due to train and vehicle dynamic Forces;

- c) Securing devices shall be correctly selected, protected against working loose, falling off or trailing from the wagon en route;
- d) Securing devices used shall be maintained in good condition and fit for use on the DFC network;
- e) Loading-specific segregation requirements shall be established and practiced ;
- f) Loading shall not protrude more than the length prescribed by DFCCIL beyond the headstock of any vehicle;
- g) Locking mechanisms on doors, containers and open vehicles shall be maintained in good condition and fit for use in respect of opening, closing, security and locking;
- h) Containers shall be placed on wagons subject to:
 - i) Operators ensuring that loading is to be evenly distributed within the container;
 - ii) Even distribution of loading between bogies;
 - iii) Loading of container trains should be done as prescribed by DFCCIL;
 - iv) Container(s) loaded in open wagons are located, secured centrally and evenly distributed over the bogies;
 - v) Open wagon side doors are secured against opening;
 - vi) Open wagons without side doors are not operated with a vacant container position, and or
 - vii) Open wagons are free of loose items.
- i) Double stacking shall be subject to:
 - i) Full height containers limited to container height not exceeding the overall height limits;
 - ii) Not exceeding maximum container loading limits;
 - iii) Containers shall be secured to each other at all four points by inbuilt spigots and locking pins or portable marine twist locks.
 - iv) Container securement devices shall be in good condition and fit for use on the DFCCIL Network
 - v) Loading of double stack containers should be done as per instructions issue by DFCCIL.
- j) Train examination shall ensure integrity of freight loading in respect of security and weight distribution, overloading, and adherence to the maximum loading gauge dimensions, as well as doors being closed. Detailed instructions regarding dimensions, classification and examination of ODC consignment originating from DFC will be issued separately.

Over Dimensional Consignment

14.5 Definition of Over Dimensional Consignment (ODC) :

Consignments, which when loaded upon a wagon, would infringe the maximum standard moving dimension, at any point, on the entire route, from the booking station to the destination, including via break of gauge is called an Over Dimensional Consignment (ODC). Therefore, any consignment exceeding the dimension quoted below for IR shall not be registered for booking unless prior sanction for its acceptance has been obtained from the Zonal headquarters.

A. Maximum Moving Dimensions from rail level (at any point) for IR network:

Description	Broad gauge
Height at Centre	4115 mm
Height at Sides	3505 mm
Maximum width	3050 mm for bogie wagon 3200 mm for 4 wheeled wagon

Note: (i) Above mentioned dimensions includes lashing and packing.

(ii) When a dummy truck is used, the maximum weight that may be loaded, in any wagon or truck is distinctly marked on each vehicle and must not be exceeded.

14.6 Classification of ODC consignment originating or terminating on IR and transiting over DFC:

ODCs are divided into 3 classes according to the minimum clearance available between the consignment and minimum fixed structure profile.

Class 'A': Those ODC loads, which has a gross clearance of 22.86 cm (9 inches) and above.

Class 'B': Those ODC loads, which has a gross clearance of 15.24 cm (6 inches) and above, but less than 22.86 cm (9 inches),

Class 'C': Those ODC loads, which has a gross clearance of less than 15.24 cm (6 inches) but not less than 10.16 cm (4 inches).

Sanctioning Authority

Class	Sanctioning Authority	Maximum permissible speed	Movement during Day or Night	Required to be escorted on IR	Required to be escorted on DFCCIL
A	Within Division : DRM, GGM(Operations) DFCCIL Inter Division within same zone : COM, GGM(Operations), DFCCIL Inter Railway : COM of zone , COM of concerned railways and GGM(Operations), DFCCIL	Sectional speed	Day and Night	–	–
B	Within Division : DRM, GGM(Operations), DFCCIL Inter Division within same zone : COM, GGM(Operations), DFCCIL Inter Railway : COM of zone, COM of concerned railways and GGM(Operations), DFCCIL	BG 40 kmph on IR Instructions regarding speed over DFC will be issued by DFCCIL separately.	Day and Night on IR. For DFC separate instructions will be issued.	TXR	Instructions will be issued by DFCCIL separately
C	CRS	BG 25 kmph Instructions regarding speed over DFC will be issued by DFCCIL separately.	Day on IR. For DFC separate instructions will be issued.	SE(C&W) SE(P Way) TI	Instructions will be issued by DFCCIL/IR separately

For ODCs originating and terminating on DFC and not transiting through IR, the classification and procedure for allowing movement of such ODCs will be separately issued by DFCCIL.

Over Dimensional Loads on Electrified Sections:

Separate instructions will be issued by DFCCIL.

Dispatch of Over Dimensional Loads

At the originating station the over- dimensional loads wagon shall only be moved when final approval has been obtained from DFCCIL/IR, and:

- a) The number of wagon/wagons carrying over- dimensional loads should be entered by the DFCCIL/IR SM or ASM and details provided to the DFCCIL/IR train controller;
- b) The DFCCIL/IR SM shall advise the DFCCIL/IR train controller and traction power/loco controller, before starting the train and while asking line clear, describe the train number with letter 'X' suffixed on it;
- c) The DFCCIL/IR train controller shall advise any adjoining DFCCIL/IR train controller or interfacing train controller details of the movement also ensuring that the consignment is moved strictly by the authorised route;
- d) Unless in emergency and then only when authorised by the DFCCIL/IR train controller, shunting of a train with an over- dimensional loads shall not occur;
- e) Loose and rough shunting of over- dimensional loads wagon on the DFC network is prohibited;
- f) When an over- dimensional loads wagon is detached from the train at a station, the operator is responsible to ensure safe placement and securing of wagon/load and then advising the Station Master.
- g) Facilities on the train, such as a passenger vehicle or brake van shall be provided for accompanying staff;
- h) When a load is so long that it cannot be accommodated in two vehicles (i.e. two 8 wheelers), it shall be loaded in three vehicles so that the entire weight is carried on the centre vehicle and the end vehicles are idlers.
- i) If the weight of the load is such that it cannot be carried on the centre vehicle, it must be carried as equally as possible on the vehicles and the centre vehicle must be an idler.

Request of ODC movement over DFC :

DFCCIL may consider train operator requests for ODC loads on a train path as follows:

- a) For non-divisible loads that cannot be reasonably reduced within the loading outline dimensions to conform to the DFCCIL structure gauge;
- b) DFCCIL shall not consider ODC loading requests for divisible items only to increase vehicle Capacity;
- c) A request for each proposed ODC load on a train path shall be submitted to DFCCIL Short Term Train Planning department for approval as published;
- d) If there is any doubt regarding ODC loading, it will not be approved by DFCCIL;
- e) ODC loads shall not operate without authorisation from DFCCIL, and
- f) ODC loading and train path arrangements include acceptability by the receiving system and is to be arranged by the Operator.

Dangerous Goods on Trains

Train operators shall establish systems and manage all requirements associated with the transport and carriage of dangerous goods including, but not limited to:

- a) Compliance with the relevant processes and acts;
- b) Separation between dangerous goods on rail vehicles and marshalling of rolling stock containing dangerous goods, and
- c) Dangerous goods shall comply with the provisions of the Dangerous Goods Code; and any regulations, provisions or exemptions to that code as approved by the Competent Authority.

15. Train Marshalling

15.1 Overview

Train operators shall establish systems and manage all requirements associated with the marshalling of trains, which involves making up the train consist, including locomotives.

15.2 Train Marshalling Principles

Train operators shall establish systems and apply train marshalling principles to ensure safe and reliable operation including, but not limited to:

- a) Loaded vehicles should generally be marshalled to the front of the train, immediately behind the locomotive(s), where possible;
- b) Lightly loaded and empty vehicles should generally be marshalled to the rear of the train;
- c) The marshalling of a vehicle within a train shall also be determined by:
 - i) Draw capacity
 - ii) Brake equipment type
 - iii) Type of rolling stock
 - iv) Dangerous goods loading and segregation
 - v) Length difference between adjacent vehicles
- d) Vehicle or loading destination shall not be used to determine marshalling sequence until safety factors have been fully considered, and or
- e) Impact on train marshalling in the event of two trains being amalgamated into one train due to operational reasons.

16. Train Inspection

Train operators shall establish systems and manage all requirements associated with the inspection of trains and vehicles.

Each train shall be examined by competent employee to ensure that all functions of the train and its constituent carriages/wagons etc. are working correctly.

The competent employee shall sign a certificate of safety test indicating duration of its validity.

The minimum inspection requirements including but not limited to trains prior to, and following entry to the DFC network, are set out in table below:

Table 16.1 - Train Inspection and Testing prior to entry onto DFC network

Circumstance	Requirements
All trains prior to DFC network entry.	Should have a valid BPC.
After train locomotives are attached to a pre-inspected train. The pre-inspection shall be carried out less than 24 hours prior to the attachment and effective security is maintained.	Should have a valid BPC
Light Locomotive Consist.	Should be fit for movement
A multiple unit train after amalgamation or division of trains where brake pipe continuity has been affected.	Should have a valid BPC

Table 16.2 Train Inspection and Testing following entry onto DFC network

Circumstance	Requirements
After pre-inspected wagon or a block / rake of wagons are attached to a train in transit. The pre-inspection shall be carried out less than 24 hours prior to the attachment and effective security of the pre-inspected wagons has been maintained.	Separate Instructions will be issued by DFCCIL
After more than one block / rake of wagons is attached to the same train in transit	
After a wagon or wagons / rake are attached and become one of the last three wagons on the train in transit.	
After a block / rake of wagons is detached from a train in transit, (not including the last three vehicles).	
After a train has been standing on the DFC network with locomotives attached provided the brake pipe is maintained fully charged and effective security of the train has been maintained.	
After a train has been standing on the DFC network without locomotives for not more than 24 hours and effective security of the train has been maintained.	
After a train has been standing on the DFC network with or without locomotives for more than 24 hours and effective security of the train has been maintained.	

17. Train Documentation

17.1 Overview

Train operators shall establish systems and manage all requirements associated with train documentation.

Note: Documents may be in electronic format.

17.2 Requirements Prior to Network Entry

Not less than four hours prior to the service commencing use of the DFC network, the Train Consist shall be documented and provided to DFCCIL wagon controller and traction locomotive controller and accurately include:

- a) Train number and date for identification;
- b) Identity of each locomotive working or being hauled;
- c) Total number of vehicles on the train;
- d) Gross load of train in tonnes;
- e) Trailing mass of train in tonnes (excluding mass of working locomotives);
- f) Length of the train in metres;
- g) Vehicles with dangerous goods;
- h) The identity and sequence of vehicles;
- i) The gross weight of each vehicle ;
- j) ODC loading if any along with the detail of permission granted by DFCCIL for ODC movement,
- k) Details of EOTT/guard on the train, and
- l) The origin and destination of each vehicle.
- m) Entry and exit stations on DFC network

In addition, the train operator shall provide to the DFCCIL wagon controller the location and details of vehicles to be attached/detached en route on the DFC.

17.3 Requirements On-Train

Train loco pilots drivers shall ensure that the following documentation remains on the train for the trains journey on the DFC:

- a) The train manifest
- b) A train inspection certificate warranting the following:
 - i) Correct braking function;
 - ii) Details of rolling stock with brakes isolated;
 - iii) Brake pipe leakage test results and;
 - iv) The identity of rolling stock used in brake holding tests.
- c) Applicable dangerous goods documentation;
- d) Applicable notices and circulars;
- e) Applicable safeworking forms;
- f) Location and details of vehicles to be attached/detached en route, and
- g) Operator specific documentation.

17.4 Requirements Following Network Entry

Whenever on-train documentation is amended to reflect changes to the train consist during its trip, these changes shall be advised to the DFCCIL train controller.

17.5 DFCCIL Requested Documentation

Upon request from DFCCIL, the train operator shall provide a copy of any documentation detailed in this section that affects the integrity of the train.

17.6 Discrepancies Affecting Operations Safety

When the train operator or DFCCIL becomes aware of a documentation discrepancy, the other party shall be advised.

When, in the opinion of either DFCCIL or the train operator, the discrepancy may impact on the safety and integrity of the train:

- a) The DFCCIL train controller shall arrange for the train to be stopped at the first available station;
- b) The train operator shall arrange for the on-train documentation to be compared with the actual composition of the train;
- c) The train operator shall provide details of the discrepancies found to the DFCCIL Station Master at that station who must provide details to the DFCCIL train controller, and
- d) The train operator shall rectify any train integrity problems and then advise the DFCCIL Station Master at the station.

Documentation discrepancies that may impact the safe integrity of the train include, but are not limited to:

- a) The actual train length exceeds the documented length;
- b) The actual train mass exceeds documented mass;
- c) The actual axle load exceeds documented load;
- d) The actual lead locomotive is not the documented lead locomotive, and or
- e) Omissions (e.g. locomotives or vehicles missed from the train consist).

When the train operator assures safe train integrity, and the DFCCIL SM or ASM has confirmed it is correct, the DFCCIL train controller may resume normal operations.

18. Train Failures

18.1 Locomotive Excessive Sanding

Excessive sanding can affect the normal operation of track circuits and the signalling system. The Locomotive Pilots of a train with a locomotive(s) applying excessive sand or sanding continuously shall:

- a) Advise the DFCCIL train controller and seek agreement to stop their train as soon as possible;
- b) Once their train has stopped, the Locomotive Pilots shall rectify the fault, and
- c) If the fault cannot be rectified, the sanding equipment shall be isolated.

If sand is needed to overcome poor adhesion conditions, the sand equipment may be cut in provided they advise the DFCCIL train controller.

In all cases the DFCCIL traction locomotive controller shall be advised who must provide details to the Train Operator.

18.2 Locomotive Wheel Spin

Uncontrolled locomotive wheel spin can cause severe damage to rails.

The Locomotive Pilots of a train with locomotive uncontrolled wheel spin shall advise the DFCCIL train controller so that rails can be inspected for damage.

If uncontrolled wheel spin occurs on any locomotive on a train, no more than three attempts may be made to move the train. If the train will still not move and/or wheel spin continues, the train shall be assisted from the section.

18.3 Trains Causing Fires

Trains with brake binding can cause fires on the DFC network. Locomotive Pilots shall be vigilant to ensure brakes that have failed to release are detected and cut out. Passing trains should be watched from both sides, where possible, for sticking brakes or other sources of fire.

18.4 Train Speed When Brakes Are Isolated

IR instructions regarding speed regulation when brakes are isolated on a train shall be followed.

18.5 Disabled Trains and Defective Vehicles

This section shall be read in conjunction with the General Rules and Procedures.

DFCCIL and Train operators shall establish systems and manage all requirements associated with disabled trains and defective vehicles including, but not limited to, providing that:

- a) Unless it is an emergency, the DFCCIL traction locomotive Controller, and the train operator's representatives of the assisting and disabled trains shall consult each other to determine and ensure application of all specific operating instructions, restrictions and technical information which may affect the safe removal of a disabled train;
- b) The DFCCIL train controller shall participate in communications between the DFCCIL traction locomotive controller, train operator's representatives and Locomotive Pilots for rail traffic management purposes;
- c) Any planning for a disabled train to be assisted or removed from the section by another train shall be made with the assistance of the DFCCIL locomotive controller and train controller;
- d) The train operator's representatives shall provide the DFCCIL traction locomotive controller with an assurance that a disabled train or a defective vehicle is safe to travel before continuing, being assisted or removed;
- e) Before a train that has divided, remarshaled or had vehicles detached continues, the DFCCIL train controller shall be provided with an assurance that the train is safe to travel;

- f) The train operator's representative shall in all cases advise the DFCCIL traction locomotive controller of any speed or other restrictions or limitations that will apply to the train as a result of technical incompatibilities or for any other reason, and
- g) A disabled train hauled may travel at normal speed provided the loco pilot is at the front and in full control of the automatic air brake of the whole train and there are no other Operator imposed speed restrictions.

When a vehicle on a train, including a locomotive, is suspected of being, or becomes defective, it shall be inspected and assessed by the train operator's representative and either:

- a) Repaired, or
- b) Made safe to travel, or
- c) Removed from the train.

Note: Defective vehicles may be detected by observation or by a wayside monitoring device.

19. Track Maintenance Machines

19.1 Types of Track Maintenance Vehicles

When operating on rail, track maintenance vehicles are used to carry out work on, or about the infrastructure. There are many types of track maintenance vehicles. DFCCIL will maintain a list of all types track machines working on DFC and provide the same to all concerned.

19.2 Registration and Warranty

DFCCIL maintains a listing of track maintenance vehicles that are registered for operation on the DFC network.

Vehicle owners/Operators intending to operate new or substantially modified track maintenance vehicles on the DFC network shall register each vehicle with DFCCIL.

For registration to occur, the vehicle owner/Operator shall warrant vehicles for compliance to relevant standards.

19.3 Vehicles Requiring Registration

A vehicle that travels, or may need to travel or be transferred on the DFC network shall be registered by the owner/operator of the vehicle.

This includes:

- a) Classified heavy weight rail bound vehicles. These shall be treated and registered as rolling stock and or
- b) Heavy weight rail bound vehicles, heavy weight road/rail vehicles and light weight road/rail vehicles. These shall be treated and registered as track maintenance vehicles.

19.4 Vehicles Not Requiring Registration

Vehicles that operate within the protection of a worksite and do not travel on the DFC network do not require registration. These include:

- a) Worksite only vehicles, and or
- b) Trolleys and trailers.

The owner/Operator of these vehicles shall establish systems to ensure compliance with the relevant technical requirements.

19.5 Operation of Track Maintenance Vehicles

Track maintenance vehicle operation shall be conducted in compliance with the relevant general rules and procedures for the area of operation.

Track maintenance vehicles shall operate and comply with the following:

- a) A light as per design approved by DFCCIL shall be fitted, unobstructed and switched on for all-round visibility;
- b) Head and tail lights shall be fitted and switched on;
- c) Audible warning detonator detection shall be fitted and whistle signals used for safety at and within worksites;
- d) The maximum allowable vehicle operating speed shall be permanently displayed in the vehicle for Operator compliance; otherwise the vehicle shall be operated at a maximum speed of 15 kmph for vehicles up to five tonnes and 30 kmph for vehicles 5 tonnes and over;
- e) Any other speed restrictions shall be adhered to that relate to the nature and characteristics of the vehicle as determined by the Constructor, Maintainer or vehicle manufacturer.

20. Interface Coordination Plan (ICP)

20.1 General

An Interface Coordination Plan (ICP) be agreed upon and implemented by those parties involved in safety related functions associated with the running of the railway, and may be between two or more parties. The Plan should form a part of the binding agreement between the parties involved.

The two main functions of the ICP are to:

- a) Define the responsibilities of each party involved, and the information that is required to be communicated across the interface, and
- b) Ensure the compatibility of the physical assets and procedural systems of each functional area of the railway.

The ICP should be developed in conjunction with the implementation of new, or modification of existing, systems and equipment, such that due consideration of the compatibility issues can be addressed from the point of conception by each party to the Plan.

The ICP shall describe the activities of each functional area in which each party will be involved, the subject matter that has been considered, and the interfaces across which coordination has been established.

20.2 Requirements and recommendations of the ICP

The ICP shall provide for the following:

- a) A full description of the scope of the railway operation being undertaken and all parties involved;
- b) Identification of the interface issues between the organisations;
- c) Clear delineation of the responsibilities of each party in relation to the interface issues and identification of the data to be communicated by each party;
- d) Identification of the nominated first point of contact for each party with respect to the Plan for:
 - i) The provision of data to other organisations; and
 - ii) The assessment of the engineering and operational systems compatibility.
- e) Identification of procedures for:
 - i) The exchange and communication of interface data and information including distribution lists, confidentiality issues and dispute resolution procedures;
 - ii) The sharing of good practice, issues of concern and relevant safety information;
 - iii) The reporting and investigation of incidents and notifiable occurrences, including reporting protocol and responsible persons;
 - iv) The auditing of each party's compliance with the Plan;
 - v) Document control; and
 - vi) VI. Review of the Plan.

20.3 Confidentiality issues

It is recognised that there are a number of issues with respect to the confidentiality of information which may arise in the preparation and implementation of an ICP, in particular the passing on of information to a competitor.

It shall not be acceptable for operators or their contractors to refuse information to network owners and vice versa on the grounds of confidentiality where that information is required to ensure operational or engineering compatibility.

Procedures for the handling of confidential information should be agreed.

20.4 Implementation of the ICP

The ICP should be implemented through standards and procedures for assessing the compatibility of engineering and operational systems identified in the ICP.

Implementation of the ICP should include:

- a) Determination and documentation of the functional parameters (i.e. Infrastructure route standards, vehicle and train operating standards) for the railway operation.
- b) Identification of the specific engineering and operational procedures that each party is committed to conform to through the ICP. These procedures should identify practices for handling infringements of the functional parameters as well as conditions of infrastructure or rolling stock that require temporarily restricted use.

20.5 Identification of Interface on the ICP

A variety of interfaces may apply at the interface between two rail operations and each requires to be identified and agreed between the parties.

Interfaces can include:

- a) Operations: Where the rules and operating process of one railway end and the other railway commences. This can be signified by a signal, infrastructure or sign.
- b) Track: Where the maintenance responsibility for one railway ends and the other railway commences. This can be signified by a signal, infrastructure, sleeper or sign.
- c) Signalling: Where the maintenance responsibility for one railway ends and the other railway commences. This can be signified by a signal, infrastructure, sleeper or sign.
- d) Overhead Equipment: Where the maintenance responsibility for one railway ends and the other railway commences. This can be signified by an air gap in the overhead, a sign or other structure.
- e) Shared Infrastructure: Where the maintenance responsibility for one railway is shared with the other railway such as signal equipment boxes, signal structures and overhead wire structures.
- f) Property: The agreed property boundary between the two rail operations.

It should be noted that the interfaces do not have to be the same for each of the above and may vary.

21. Coordination of Emergency Rescue Operations

21.1 Purpose

The purpose of this operating procedure is:

- To delineate responsibilities and procedures for the control and coordination of all responses to emergency situations on the mainline.
- To provide step by step guidance on how to deal with incidents should they happen

Train operators and DFCCIL employees shall provide suitable training to ensure all tasks are known in the event of a serious incident.

21.2 Objectives of Incident Management Plan

Objectives of the Incident Management Plan are but not limited to (in order):

- a) Save lives and alleviate suffering, then
- b) Where necessary, assist Indian Railways in providing help to stranded passengers and arrange their prompt evacuation, then
- c) Instil a sense of security amongst all concerned by providing accurate information, then .
Protect Railway property, then
- d) Ascertain the cause of accident, preserving clues by cordoning of incident site, then
- e) Expedite restoration of rail operations

21.3 Definitions

Term	Definition (Meaning)
Incident	An event that caused a delay to train services
Accident	An event which has the potential or causes loss of life and or injury and damage to property
Emergency/ Serious Accidents/ Disasters	An event that may or may not necessarily be the outcome of train accidents but have the potential to cause loss of life and or injury to human beings causing further death/injury and wide spread and prolonged distress to all those involved.
Disaster Management Team	A team of DFCCIL and Rail Operators Railway officials earmarked to reach incident site by first available means and take over site management

21.4 List of serious incidents requiring use of this plan

- a) Fire, smoke emission, explosion on railway premises including trains;
- b) Derailment of a passenger carrying train fouling the DFC network;
- c) Derailment of a train on the DFC network affecting the safety of parallel lines of an alternative rail network;
- d) Collision of a train/trains
- e) Security threats/Terrorist attacks, widespread violence, bomb explosion;
- f) Release of Chemical or biological gas in trains, stations or tunnels, and or
- g) Natural calamities like cyclone, floods and earth quakes.

21.5 Responsibility of Site Management

Management of an emergency on the DFCCIL network is the responsibility of DFCCIL. Management may include participation from an adjoining rail network should that network be affected.

When an event occurs on the DFC network:

- a) The GGM (Transportation)_ or designated DFCCIL control office supervisor, is responsible for the overall control and coordination of emergency situations on the DFC network for train operation. Executive Director of the concerned corridor will nominate Officer in Charge(OCSS) of site (Normally the senior most officer on the site shall be designated as OCS).
- b) The OCS is responsible for overall control and coordination of all activities at the incident scene under instructions of the DFCCIL train controller, and where applicable, the IR train controller;
- c) Traction, track and structure, signalling, and telecommunication, fire service & security personnel are responsible for providing technical assistance to the DFCCIL train controller and OCS;
- d) The train operators wagon control is responsible for providing technical assistance to the DFCCIL train controller and OCS;
- e) IR and DFCCIL employees are responsible for providing information, rendering first aid, mobilizing medical , fire services and assistance from civil administration, including police and providing all other assistance in alleviating suffering and hardship to people;
- f) Security Agency nominated by DFCCI/IR will be_ responsible for securing the incident scene and for performing/directing investigation activities in compliance with existing procedures. (in case of incidents caused by criminal acts);
- g) The senior police official at the scene are responsible for controlling and coordinating all police activities at all times. In doing so, this official has final authority to determine when these activities are complete and shall coordinate these activities with the OCS, and
- h) Security personnel are responsible for assisting the civil and railway police; fire services personnel, medical services or station staff as directed by OCS.

21.6 Staff Authorised to act as Officer in Charge of Site (OCS)

The following positions may be authorised by the DFCCIL train controller to assume the duties of OCS pending the arrival of the DFCCIL SM or other management at the site:

- a) Locomotive Pilot or Guard of the affected train, including a train on a parallel line operated by an alternative rail operator;
- b) DFCCIL or IR SM or ASM reliant on who is first on scene;
- c) DFCCIL or IR operations supervisor or traffic inspector reliant on who is first on scene;
- d) Any railway officer of any railway organisation either on duty, off duty or on leave, present at the site of incident and or
- e) DFCCIL or IR members of Division Disaster Management Team reliant on who is first on scene.

When none of the above mentioned personnel are present at the scene, the DFCCIL train controller shall appoint an OCS as directed by GGM(Transportation)/ ED of the corridor concerned.

The method of managing an emergency situation will be in compliance with the applicable DFCCIL Emergency Management Plan and where applicable, the DFCCIL General Rules and Procedures, the IR General Rules and Procedures (where applicable) or as directed by the DFCCIL train controller during incidents not covered by the relevant General Rules or Procedures.

The OCS is responsible for issuing directions to personnel and authorising the mobilization of equipment required at the scene on the DFC network and to command the removal of any unnecessary personnel or equipment from the scene. This does not apply to police or Fire Department personnel.

The OCS must continuously coordinate all activities with the Indian Railway OCS where a parallel line is affected.

Entry into the incident area by the news media or other visitors must be authorised shall be coordinated with DFCCIL train controller, the Rail Manager, OCS and or Police.

When it is necessary to notify the Fire Services, and or to seek medical assistance the following information shall be provided:

- a) Identification of caller;
- b) Nature of problem (give in plain English, /Hindi e.g., fire, flood, smoke, injuries);
- c) Type of assistance requested; be specific
- d) Specific location of the problem and the best access points;

21.7 Procedure

21.7.1 Duty of DFCCIL Train Controller

Immediately when an incident/accident/disaster is reported the DFCCIL train controller shall:

- a) Establish the location of the event;
- b) Immediately warn the IR train controller of the event;
- c) Immediately warn the loco pilot of all trains operating on the DFC network within the specific area to approach the site prepared to stop;
- d) Advise the DFCCIL SM or ASM at stations either side of the incident and request that signals to be placed at stop;
- e) Request the DFCCIL SM at a nominated station to attend the site;
- f) Advise the Chief Controller/Operations Manager of the event;
- g) Commence arranging emergency services to attend the site;
- h) Continue to liaise with field personnel regarding ongoing management of the site, and
- i) Appoint an OCS.

21.7.2 Duty of Locomotive Pilot

Immediately when an incident/accident/disaster occurs on a train the Locomotive Pilot shall:

- a) Provide constant warnings through train radio/ Emergency Call/Flasher Light to stop any trains operating on parallel lines;
- b) Advise the DFCCIL train controller of the event;
- c) Take steps to warn the IR train controller or IR SM or ASM at stations of the event if necessary, and
- d) Assume the role and perform the function of OCS until relieved by a DFCCIL manager.

21.7.3 Duty of OCS

The appointed OCS shall:

- a) Ensure that all personnel involved, at the scene, work efficiently to restore rail service as quickly and safely as possible;
- b) Control and coordinate all field activities with personnel at the scene;
- c) Coordinate all police related activities and requirements with the senior police official at the scene;
- d) Coordinate activities with the senior Fire Department official at the scene and, when available, provide the Fire Department Command Post with a knowledgeable employee, to act as a communications link to DFCCIL train control and to the OCS;
- e) Establish a command post, at the incident scene;
- f) Direct all inquiries and/or requests made by jurisdictional police officials to senior management
- g) Maintain a chronological log of all events.
- h) Establish a command post, at the incident scene;

21.7.4 Senior Management Actions

The GGM (Transportation) or designated DFCCIL Control Office Supervisor shall:

- a) Liaise with senior management of the train operator;
- b) Liaise with senior management of the IR when affected;
- c) Coordinate all field activities and requests through the OCS;
- d) Notify members of Disaster Management Team and all departments and personnel, as required;
- e) Coordinate and direct the safe movement of all trains, to include those trains which may be involved in the incident.
- f) Request Police /RPF assistance in critical stations for crowd control;
- g) Coordinate and assist OCS with restoration activities, and
- h) Provide and obtain, from OCS frequent updates on events;
- i) Coordinate and direct the safe movement of all trains.

21.7.5 Setting of Site Control Office at the Site

The DFCCIL Operations Manager, Assistant Operations Manager, or designated DFCCIL Control Office supervisor may choose to set up a Site Control Office at the site.

The Site Control Office will be manned by the OCS and other senior management at all times until the site is cleared and normal operations have been resumed.

21.7.6 Dealing with Passenger Trains on the Indian Railway Network

The IR Emergency Plan details the requirements for dealing with passengers on passenger trains and shall be complied with by the nominated Indian Railway OCS.

The requirements include providing refreshments, making announcements and arranging the clearance of the injured and deceased.

The DFCCIL OCS may provide assistance to the IR OCS where necessary.

DFCCIL employees shall not provide accident details affecting passenger trains to any member of the public and must refer such details to the nominated IR OCS.

21.7.7 Dealing with Goods Train on the DFCCIL Railway Network

In case of involvement of Goods Train on the DFC network, following actions will be taken promptly in coordination with the train operator:

- a) Make arrangements of adequate labour by mobilising resources available at other stations as well as from the market locally, for unloading of material from the wagons involved in accident;
- b) Allocate adequate tarpaulins to cover the contents so that these are saved from weather, and
- c) Make arrangements for retrieval of loose materials lying at the site of accident;

The train operator will be responsible for

- a) Advising consignor/consignee of the event;
- b) Arrangements of road transport for evacuation of the contents from the site of accident, and
- c) Supply of adequate empty stock for transshipment /disposal of the contents. Labour for transshipment/ disposal activity will be arranged by Operator.

21.7.8 Removing Train or Vehicles from Site

Removal of the train from the incident site shall be undertaken in accordance with the DFCCIL General Rules and Procedures.

In the event that the overhead traction equipment is affected, arrangements must be made between the DFCCIL OCS and the train operator to source a diesel locomotive to assist with the train recovery activities.

22. Preferential schedule and rationalization

22.1 Preferential Schedule

Movement of wagon load traffic, is regulated by what is known as the Schedule of Preferential Traffic, laid down by the Central Government (Railway Board) under Section 71 of the Railways Act, 1989 and is designed to ensure that certain essential commodities and urgent movements are accorded necessary preference at a time when the available transport is not adequate to meet with all the demands.

As per Railway Act, traffic is classified into 4 categories viz., A, B, C, and D. Commodities registered in the lower categories cannot have preference over those registered in the higher categories although the former may have been registered much earlier.

- a) This Priority Schedule is decided by Traffic Transportation Directorate of Railway Board.
- b) It lists the Sponsoring Authority and Accepting Authority for programmed traffic. (Copy of Priority Schedule can be obtained from Indian Railways website)

22.2 Rationalization Order

Under section 71 of Railways Act 1989, Railway Board has been empowered to charge freight over route, which may not be the shortest between alighting point and destination. The Rationalization order indicating the route through which the freight is to be charged is issued by traffic transportation branch, Railway Board.

Revised rule 125 of IRCA Goods Tariff Part I (Volume-I) vide Board's letter no. ECR/1125/94/3 dated 6/10/94 through which it has been that directed unless there is specific instruction in writing from the centre or his authorised agent to the contrary, goods will be despatched by the route optionally feasible and freight charges will be levied by the shortest route. However, charging of freight by shortest route is subject to any instructions issued under rationalized order issued from time to time.

23. Station Working Rules

General Rules 7.17 of DFCCIL, stipulates

“7.17 Station Working Rules.- In addition to the General Rules and Subsidiary rules for DFCCIL, each station shall be provided with Station Working Rules (SWR) applicable to the station issued under special instructions. It shall give complete description of train operation in normal as well as in abnormal condition as per the lay out and signalling equipment of the station. The SWR must invariably be updated immediately in case of any changes in the lay out or signalling equipment or introduction of any innovation or device to facilitate train operation or to ensure safety. Each page of the SWR must be numbered along with Station code. Each page should be initialled and last page signed in full by designated Operating and Signalling officials, affixing their designation, appointed in this behalf by the authorised officer of DFCR.

A copy of the station working rules or a relevant extract thereof shall be kept at stations and level crossing concern. SWR is to be issued in Bi-lingual i.e. in English and Hindi (Devnagri Script) form.”

In compliance with the stipulation of General Rules, SWRs will be prepared for all DFCCIL stations.

23.1 Purpose of SWR

The purpose of issuing SWR is to inform all staff concerned with working of trains about the special features of the station to ensure safe train operations on DFC network & between stations including level crossings, depending on local conditions.

23.2 Authority to issue SWRs:

- a) Under the provisions of DFC GR 7.17, the authority to issue SWRs rests with the officer appointed in this behalf by the authorised officer of DFCCIL.
- b) SWRs are issued in conformity with the G&SR and Operations manual of DFCCIL and cannot, in any way supersede them. In case of any conflict, the provisions of G&SR and Operations manual will prevail.

23.3 SWRs requiring sanction of Commissioner of Railway Safety (CRS):

- a) At stations where relaxation has been obtained from provisions of General Rules under approved special instructions, the approval of CRS already obtained, if applicable, shall find place in the SWRs.
- b) DFCCIL administration must obtain sanction of the CRS, when the SWRs are revised because of any work listed in para 1302 of the Indian Railways PWay Manual.

Para 1302 of the P Way manual reads as under:-

“1302. Works requiring the sanction of Commissioner of Railway Safety and Notice therefor –

- (1) Under section 20 of Indian Railways Act and chapter VI of the "Rules for opening of a Railway or Section of a Railway for the public carriage of passengers,1933", the sanction of Commissioner of Railway Safety is required for the execution of any work on the open line, which will affect the running of trains carrying

passengers and any temporary arrangement necessary for carrying it out, except in cases of emergency.

- (2) For the commencement and opening of the following works, when they are connected with or form part of Railway already opened, the sanction of the Commissioner of railway safety shall be obtained:
- (a) Additions, extensions or alternations to running lines.
 - (b) Alterations to points and crossings in running lines.
 - (c) New signalling and interlocking installations or alterations to existing installations.
 - (d) New stations, temporary or permanent.
 - (e) The construction (but not the removal) of an ash pit on a running line.
 - (f) Heavy regarding of running lines involving lowering/ raising of track in excess of 500mm.
 - (g) New bridges including road over and under bridges, foot over- bridges, strengthening, raising; reconstruction or extension of existing bridges, addition or replacement of existing girders, including provision of temporary girders.
 - (h) Provision of new level crossing, shifting of existing level crossing on running lines, demanning and downgrading of level crossing, manning of unmanned level crossings, upgrading of level crossing involving changes in the method of working or operation (such as interlocking, provision of lifting barriers in place of gates etc.) and closing down of level crossings.
 - (i) Permanent diversion (deviation) more than 2 kms. in length without any station in between and irrespective of length, when a new station is involved.
Note :- Permanent diversions more than 2 kms. in length, and irrespective of length when a new station is involved, are to be treated as new lines covered by the provisions of section 17 to 19 of Indian Railway Act.
 - (j) Temporary diversion irrespective of length, except those laid for restoration of through communication after accident.
 - (k) Addition or alterations to the electrical installations of tracks equipped for electrical traction.

- (3) Application for any alterations, reconstruction or additions that require the sanction of Commissioner of Railway Safety should ordinarily be made 30 days in advance of the expected commencement of such work.

If for any reason a sanctioned work is not taken in hand within 12 months from the date of sanction, the Commissioner of Railway Safety should be approached for renewal of the sanction.

23.4 Preparation of SWR

- a) Nominated Signal officer will prepare/ amend the rule diagram on the basis of signalling plan appendices and send the rule diagram and also signalling plan/ appendices in case of interlock system, to the nominated operating officer for framing Station Working Rule
- b) Since the Rule Diagram has a vital bearing on the preparation of the SWRs, the nominated Operating officer will scrutinize the Rule Diagram and the Signalling Appendices, if any, and have these checked at the site.

- c) The nominated operating officer will arrange for preparation of the Draft Working Rules by the APM/ Traffic in the Standard Format, after which these will be checked and approved by the nominated Operating officer. In case of interlocked stations, the Draft Working Rules shall be checked and approved by nominated Signal officer. Electrical officers shall also be associated in electrified sections.
- d) If there is a 'D' (Flag Station) and 'DK' (station with siding) between two Block Stations, the SWRs of the Block Stations on either side shall contain a reference to such D/DK class Station (in Appendix 'F' of the SWR). In the case of a DK class station, the special instructions for working the siding shall also be incorporated in the SWRs of the Block Stations situated on either side of the 'DK' class station. A copy of these special instructions along with the Rule Diagram shall be made available at such DK class Stations.
- e) LC Gates controlled by the Stations and rules for their working shall be incorporated in Appendix A of SWR.

23.5 Responsibility of the Officers signing the SWRs :

- a) SWRs are the functional rules governing the working of stations. These need to be prepared with care and attention as any deficiency in these rules can endanger safety, in which case the officers signing the SWRs shall also be held responsible along with other staff for breach of safety rules.
- b) It is obligatory that the rule diagram of the ground conditions are compared at site to confirm accuracy of Rule Diagram. In absence of officials signing the SWR having verified it personally, the AM/Traffic and AM/Signal will, after having jointly inspected the site shall certify in writing that the actual layout conforms to what is shown in the Rule Diagram and the number of points and signals quoted therein are correct.

23.6 Reviewing of SWRs:

In case of a new station commencing operations, the SWR should be reviewed after one year. After that the SWRs should be reviewed once in every five years. In case the review brings out the necessity of carrying out changes, the SWRs should be re-issued. In the event of more than three correction slips having to be issued, the SWRs should be reissued without waiting for the periodical review to be conducted every five years as mentioned above.

23.7 Method of correcting SWRs:

Whenever any addition/amendment is required to be made in the said rules, the entire page/pages duly signed by concerned officers on which the provisions requiring addition/amendment appears should be replaced. The method of pasting correction slips by hand in the SWRs is not permitted.

23.8 Responsibility of AM/Traffic

- a) The AM/Traffic is responsible to see that SWRs of stations on his section are correct and upto date. He will also be responsible to ensure that the station staff viz. Station Master and Assistant Station Master/ Pointsman and any other staff who are in any way connected with train passing duties, possess correct knowledge of the Rule Diagram and the SWRs and observe them strictly.

- b) AM/Traffic will also check the SWRs, Rule Diagram, and point out irregularities, if any, detected by him. If he finds that certain rules are impracticable thereby forcing the staff to infringe them, he shall immediately bring this matter to the notice of the nominated operations officer. If he detects any error or omissions, which, in any way, affect safe running of trains, he shall take immediate steps at the spot as necessary for safe working of trains and report the matter to the nominated Operations officer including the necessary amendment/ modification required in the SWRs.

23.9 Responsibilities of Station Master:

The Station Master on receipt of the SWRs must immediately check to ensure that these conform to the local conditions at their stations. If he finds any discrepancy in the said rules, he shall immediately bring such discrepancies and difficulties to the notice of the nominated Operations officer of the corridor. The Station Master shall see that all staff having definite responsibilities in train passing at their stations correctly understand and follow the SWR.

23.9 Assurance of staff:

- a) All the staff who are in any way associated with train passing duties, must sign a declaration in the Assurance Register in token of having studied the SWRs, Rule Diagram and other instructions pertaining to their duties and understood the same and that they are in a position to take up duties independently at the Station. The Station Master/ Assistant Station Master shall also certify that the staff concerned has understood the instructions pertaining to their duties.
- b) Fresh assurance shall be obtained in the Assurance Register from the staff concerned when:
 - i) He joins at the station as a new member,
 - ii) There is any change in the Station Working Rules,
 - iii) He resumes duty at the station after an absence of 15 consecutive days or more.

23.11 Distribution of Station Working Rules:

Unless otherwise notified the distribution of the Station Working Rules and correction slips thereto will as follows:

- a) One copy to each of the following:
 - i) Commissioner of Railway Safety
 - ii) ED of the corridor concerned
 - iii) Director (OP&BD)
 - iv) GGM(Safety)
 - v) GGM(Infrastructure)
 - vi) GGM(System)
 - vii) AGM/JGM (Signal)
 - viii) AGM/JGM(Electrical)
 - ix) AGM/JGM (Civil)
- b) Two copies to the following:
 - i) GGM(Transportation)
 - ii) AGM/JGM (Transportation & Safety)
 - iii) Station concerned
 - iv) Chief Controller of Corridor

Note:

- a) One of the two copies supplied to the AGM/JGM (Transportation & Safety), one will be for his office record and the other will be kept reserved for being carried in the Inspection Specials
- b) Out of two copies supplied to the stations, one will be kept with the Station Master and the other will always be kept in a case provided for the purpose in the office of Station Master on duty.
- c) The number of the copies suitably increased for the stations where additional places for train operations are provided so that a copy of the Station Working Rule is kept there at as prescribed by the GGM (Transportation).

23.12 Standardization of SWRs:

To maintain uniformity in the SWRs, the format as prescribed under Appendix A of this manual shall be used while framing/revising the Station Working Rules for stations. Care may, however, be taken to ensure that:

- a) The SWRs framed as per the format are self-contained, brief, precise to the point and written in simple spoken language and
- b) General and Subsidiary Rules need not be reproduced in the SWRs. Relevant GR/SR number, may be mentioned in bracket against each para when required.
- c) Nominated Operations, Signal and Electrical officials are required to add those special items or features having a bearing on safety in operation at the concerned Station, which is not covered by the format given in Appendix A.

24. Temporary Working order and Non-Interlock Working of Stations

24.1 Temporary Working Orders

Temporary Working Order (TWO) is an embodiment of detailed instructions issued and circulated by the AGM/JGM Operation whenever any pre-planned work of signalling, electrical (OHE) or engineering (Civil) department is to be executed, requiring special safety precautions to be observed by staff.

- a) Circumstances under which 'TWO' is to be issued:
 - i) When the nature of work is such that it will require the imposition of speed restriction for more than one day.
 - ii) In all the cases when addition or alteration in the layout of the Interface or yard or to permanent signalling and interlocking arrangements are to be made.
 - iii) Over hauling of the signal.
 - iv) The nature of the work involves temporary cessation of working of the trains.
 - v) For construction of all new installations on or near the track, such as new station, foot over bridge, OHE, renewal of track, providing temporary diversions, etc.

- b) Procedure for preparation of Temporary Working Order/Instructions:

The draft of TWO shall be prepared by the supervisor concerned viz. Depot Engineer Civil for engineering works, by the Depot Engineer S&T for signalling and interlocking work and the Depot Engineer Electrical for electrical works detailing the requirement of the work and precaution to be observed. This preplanning of the work is known as Draft of TWO.

Draft TWO is submitted by the above listed official to their Corridor Officers i.e. GM Infrastructure for the corridor. After the draft TWO is checked and justified by the GM Infrastructure, S/he will send the draft TWO to the GGM Transportation who will include instructions for regulation of Traffic during the execution of work and will issue the TWO with detailed instructions including the safety precautions to be observed during execution of work.

24.2 Non Interlocked Working (NI Working)

- a) N.I. Working means temporary disconnection of points, signals, track circuits, axle counters and other signalling gadgets for any designated works. This kind of working is normally resorted to works such as yard remodelling, introduction of panel/RRI working, cable etc.
- b) In another sense, at an interlocked station when points and signals become defective, station becomes non-interlocked for the purpose of working.

In both the cases the safeguards ingrained through normal functioning of various signalling equipment are missing and as such responsibility of the part of staff increases manifold. N.I. working puts staff under severe strain and hence prone for lapses. Unflagging attention from every quarter is the need of the hour so that safety is ensured.

Non- Interlocked working entails not only slowing down of train operations; it is also a less safe system as compared to interlocked working. Since it is desirable to avoid NI altogether, both from safety as also customer convenience point of view, attempt must be made at the project proposal stage itself to dispense with NI altogether and undertake the work by means of traffic blocks.

Instructions given below are in addition to any rules for Non – Interlocked working as may be prescribed by DFCCIL. They must be read together with existing provisions in DFCR- GR and other manuals.

24.3 Requirement of Non – Interlocked Working:

The following guidelines are laid down for a correct assessment of whether NI working is required in the first place or whether it can be dispensed with altogether.

- a) NI working should not be resorted to as far as possible, in case of installation of new S&T gears. NI is unavoidable only if modifications are to be made to existing S&T gears.
- b) For new S&T gears, there is no need of NI and the work can be managed through well-planned pre-change over works (insertions of point & crossing etc.). The final change over to new gears can be carried out under partial or complete traffic block.
- c) At the project proposal stage itself, S&T department should make it clear whether the project requires NI or not; and if it does, the duration of such NI. This fact must be mentioned in the check list on the original tracing itself.
- d) AGM/JGM Operations or any other official must quantify the actual impact of such NI, and deduce it to monetary terms, by calculating anticipated losses on account of freight traffic. These should include losses on account of cancellation, detention to trains and imposition of restriction on booking/movement of freight traffic.
- e) Expenses likely to be incurred on account of TA/DA of temporary NI staff, and other administrative costs should also be added to arrive at the traffic cost of proposed NI working.
- f) This traffic cost of NI should be communicated to S&T, who will evaluate if new gears can be installed without resorting to NI for less than the expected cost of proposed NI, if necessary by constructing a new building etc. as the case may be.
- g) If new gears can be installed in a new building and commissioned under traffic block at a cost that is comparatively less than the overall traffic cost of proposed NI, then the project should be recorded as one to be taken up without NI.
- h) This entire exercise must be carried out under the personal supervision of Executive Director of the corridor who will ensure that all estimates are reasonable and no figures are unrealistic both with regard to duration of NI or the anticipated traffic cost.
- i) Thus, NI will be undertaken only if found to be unavoidable, and this fact will be recorded on the original tracing, to be signed by officers concerned, and the Executive Director.

24.4 Minor and Major Works:

- a) Guidelines given below should be followed for deciding whether NI working is required or not. NI working is required only for following cases :

- i) Overhauling of S&T systems.
 - ii) Replacement of EI at road side stations.
 - iii) Meggering of cables.
 - iv) Changes to S&T system requiring NI working after approval of GM Infrastructure
 - v) Any other requirement duly approved by ED of concerned Corridor
- b) NI working can be divided into 2 distinct categories, namely minor and major works:
- i) Minor works – eg. Overhauling of S&T systems.
 - ii) Major works – Changes in yard or interface layouts, overhauling of cabins etc. at junction or interface stations.

24.5 MINOR WORKS

Procedure to be followed for Non – Interlocked Working for Minor Works:

- a) Stations with road connectivity on corridor are covered under this heading of Minor Works.
- i) Duration of NI working for Minor Works:
The nature of Minor works should be such that it can be divided into independent modules of 10 hours each. Such independent modules may not be interlinked and must allow for interlock working after each module. The cumulative duration of such works shall not exceed more than one day. S&T department must suitably augment the strength of their NI gang so that required works can be completed during this time frame.
 - NI working should start at 0800 hrs. in the morning and completed by 1800 hrs. so that the interlocked working commences after 1800 hrs and station is handed back to traffic.
 - The same procedure should be repeated the next day.
- b) General Instructions for Train Operation :
 - i) Speed restriction of 15 kmph shall be imposed over all facing points.
 - ii) No train/wagon should be stabled on any running line of the NI station.
 - iii) The common line should not be used for reception of trains coming from opposite directions.
 - iv) Emergency and other crossovers including sidings and interfaces taking off from the station should be set for normal position and clamped and padlocked. The keys of all padlocked points must be kept in the personal custody of the overall in-charge of NI working to prevent their being used even by mistake.
- c) Train Running on double line section during NI working :
 - i) No temporary single line working should be introduced during NI period, except in case of an accident or blockade of through communication.
 - ii) At road side stations on double line, route must be set for main line in each direction and clamped and padlocked.
 - iii) At all such stations no precedence should be arranged.

- iv) During the NI period station should basically function as a halt station.
- d) Staff requirement :
 - i) Station Master and Depot Engineer-S&T will be overall in-charge of NI working at the station.
 - ii) Additional staff if required should be managed locally from nearby IMD/IMSDs.

24.6 MAJOR WORKS

Procedure to be followed for Non – Interlocked Working for Major Works:

This shall pertain to items which do not comply with condition set in 24.4.1 a) i) above. Examples include changes in interface layouts, overhauling or installation of new S&T system etc. are covered under this heading of Major Works.

24.6.1 Duration of Non Interlocked Working:

- a) NI working must not be simultaneously introduced at more than one station in any corridor.
- b) NI must be planned during temperate weather, to avoid wrong actions on account of harsh and inclement weather.
- c) Period of Non – interlocked working must be kept to the bare minimum as it is a potential safety hazard.
- d) Staff of all departments must work round the clock in three shifts so that the work can be completed at the earliest.
- e) For each NI Working, plans will be finalized in consultation with ED of Corridor, GM/Transportation, and concerned GM S&T/Civil /Electrical as the case may be.
- f) For more than 3 days NI, plans should be worked out for cancellation or diversion of freight trains as the case may be.
- g) For NI working of more than 7 days personal approval of the Managing Director must be obtained.
- h) No NI working should last for more than 14 days.

24.6.2 Sanctions, clearances and preparatory works:

- a) Signal Plan must be finalised in Corridor Headquarters at least 45 days in advance.
- b) All plans and clearances including CRS sanctions that are required for NI working must be available at least 1 month before commencement of NI working.
- c) Under no circumstances should this period of 1 month be relaxed.
- d) NI working must be postponed in order to provide for 1 clear month before start of NI either in case of :
 - i) Delay in receipt of above clearances/sanctions etc.
 - ii) Last minute modifications to Signal Plan.
- e) All pre – NI work that can be carried out without non – interlocking must be completed before actual NI working begins. These include changes in Interface layout, insertion /removal of points & crossings etc. Changing/installation of new point machines must be done in advance.

- f) Preparatory work in connection with OHE work must also be done in advance, including shifting of neutral section, if required.
- g) Lessons learnt during previous NIs must be gone through in detail so that shortcomings of earlier occasions are avoided.

24.6.3 Level of Supervision/Responsibility :

- a) Responsibility to ensure availability of proper arrangement for NI working shall be of concerned department.
- b) Though the responsibility to provide necessary arrangement will be of concerned department, the DFCCIL officers from Regional/Corridor Head Quarter & IMD shall be responsible to ensure its availability and functioning during train operation. For this they shall be the coordinating officer for the department concerned.
- c) PERT (Planning Evaluation Review Technique) chart should be made out detailing various activities to be completed on a day-to-day basis.
- d) For round the clock working PERT chart should be made out detailing various activities to be completed on a shift to shift basis.
- e) Depot Engineers as applicable shall make themselves available in non-interlocked area where the work is being undertaken.
- f) The concerned department in -charge shall camp near the non-interlocked area till completion of non-interlocked working.
- g) Overall in charge for NI working will be GGM Transportation GGM Safety as the case may be for both Safety and Operations.

24.6.4 Green Notice :

- a) The concerned officials responsible for carrying out the work should send a 'circular notice' to the GGM Transportation, & GGM Safety, Station Master & in charge of IMD/ISMD at least two months in advance.
- b) They will advise as to when the work will be undertaken with a request to issue special instructions.
- c) GGM Transportation & Station Master & in charge of IMD/ISMD on receiving such 'circular notice' get special instructions prepared for that station. These are then issued to all concerned.
- d) Green notice is to be issued by GGM Transportation. It should incorporate the following:
 - i) Details of existing yard or Interface layout and its various provisions.
 - ii) List of all works to be completed by Civil Engg./S&T/Elec. before start of NI.
 - iii) List of all works to be undertaken by Civil Engg./S&T/Elec. during NI period.
 - iv) Additional facilities to be made available after commissioning of new works.
 - v) Existing facilities that are to be dismantled.
 - vi) Details of Interface or yard layout to be made available after completion of NI.
- e) Signalling Plan must indicate permissible routings and simultaneous movement facilities to be made available.
- f) Signalling Plan must invariably indicate whether any of existing facilities for train movement are to be
 - i) either curtailed,

- ii) modified or
- iii) restricted.

24.6.5 Time Tabling changes :

For assessing the impact of NI working at a bigger Interface or at a Junction station, a detailed exercise has to be undertaken as indicated below.

- a) During the course of NI working changing of points manually or automatically after passage of a train and after completing all formalities takes about 10 minutes time.
- b) The capacity of the junction station to handle maximum number of trains during a particular time period has to be worked out keeping in mind the above constraints.
- c) Every possible train movement of reception and despatch must be clearly documented,
 - i) Along with time of movement.
 - ii) With exact sequence of points, whether in normal or reverse.
- d) Trains demanding same point either at the same time or within 10 minutes must be identified since this is the time required before an existing setting of points can be changed. In case of conflicting moves, the less important moves have to be cancelled or rescheduled.
- e) Crossing and precedence must be restricted to the bare minimum with few specific routes being selected for most movements.
- f) As a thumb rule, only 80% of the reduced capacity as worked out should be utilized since unforeseen failures such as, equipment failures etc. are likely to take up the remaining 20% of the available capacity.
- g) In all such planning it is better to keep adequate cushion in train operations and initially cancel or reschedule number of trains than what may be required. In case NI working progresses smoothly without major detentions and it is felt that some of the cancelled trains can be restored, the same may be done after a week or so.
- h) Clear corridor for all trains must be charted out, with exact number of moves possible, and operating restrictions must be imposed, if required.
- i) More time must be spent in precise planning of each move during NI period, such that the station is not brought under pressure at any time.

24.6.6 Advance preparation for Train Running :

All efforts must be made to minimize detentions.

Crew Changing:

- a) Crew changing, if required, may be planned at adjoining stations.
- b) Controlling of Trains:
 - i) In case of major terminal stations, a mini control office may be opened at the station. This mini control will liaison with DFC/ divisional control office for purposes of train running. The jurisdiction of this mini control office would be the NI station itself, and 2 – 3 stations on either side in each direction.

- ii) Station undergoing NI must not be permitted to be brought under any pressure whatsoever at any time during NI working.
- iii) All relevant notices must be issued in advance.

24.6.7 HOER :

- a) Under no circumstances HOER violation should be permitted during NI working. As far as possible duty hours of staff should be restricted to 8 hrs. duty per shift in continuous roster.
- b) For catering to unexpected events such as leave, sickness etc. during the NI period, RG and LR staff must invariably be provided for.
- c) RG and LR must be made available shift wise. The standard of RG and LR should be the same as that of regular duty cadre staff for that shift as stipulated.

24.6.8 Duty Rosters shift wise:

Meticulous detailed planning must be carried out for drawing up roster of staff to be deputed for NI working. While drawing up roster of staff for various shift duties, following guidelines must be followed:

- a) Duty Roster should be drawn up for the entire duration of NI period.
- b) Duty rosters drawn up should be openly displayed and given wide publicity.
- c) No staff shall be permitted to mutually exchange his duty roster with any other staff, without prior permission of his supervisor at site.
- d) Level 'N + 1' shall be responsible for ensuring that level 'N' has followed all instructions, etc. as laid down above.
- e) Last Night Shift Duty:
 - i) Regular staff permanently posted at the NI station must be rostered during the last night shift.
 - ii) Second preference should be for staff who have previously worked at that station.
 - iii) Best and most competent supervisors should be deployed for last night shift duty.
- f) First Night Shift Duty:
 - i) Regular staff permanently posted at the NI station, if still available for deployment after covering last night shift, should be rostered for first night shift duty.
 - ii) Second preference should be for staff who have previously worked at that station.
 - iii) Amongst outstation staff preference should be as follows :
 - Senior staff having previous experience of NI working.
 - Staff who are presently posted at major junctions or interfaces.
- g) Day Shift Duty:
 - a) Comparatively junior inexperienced staff from outstation should be deputed for day shift working.
 - b) For day shift working, more number of staff may be deputed per locations, if required, to cater for comparatively inexperienced staff.

24.6.9 Temporary Working Instructions (TWI) :

- a) When NI is undertaken, inter – locking provisions stipulated in SWR are no longer available. So the SWR in its existing form becomes invalid.
- b) TWI is basically meant to replace some portion of Station Working Rules of the station during the period of NI working. While they need not be as detailed as the original SWR of the station, nevertheless, they must cover all aspects of train operation that are included in the existing SWR.
- c) Static information of SWR will continue to be valid. These include :
 - i) Inter – station distances.
 - ii) Description of Interface or yard layout.
 - iii) Level crossing gates.
- d) TWI is to be read in conjunction with DFCR- GR, Operating Manual etc. It must also be read along with existing SWR of the station.
- e) Portions of SWR that will get replaced pertain to:
 - i) Ensuring clearance of running lines.
 - ii) Granting of line clear.
 - iii) Reception/despatch of trains.
 - iv) Working of level crossing gates.
 - v) All checks that are done by means of :
 - Slots.
 - Point locks.
 - Signals.

All these checks have to be taken care of manually.
- f) TWI should list out procedure for portion of yard or interface control and procedure for reception / departure on/from different lines.
- g) TWI should list out different conditions required to be fulfilled for reception/despatch of train :
 - i) How line clear is to be granted/obtained.
 - ii) How clearance of nominated line is to be ensured.
 - iii) Procedure for closure of level crossing gates, if any.
 - iv) How the route is to be set.
 - v) What are the series of points involved.
 - vi) Which one of them are to be in normal position and which ones in reverse.
 - vii) How signals are to be taken 'off'
 - viii) Which staff would do what

24.6.10 Field level Advance Preparation:

- a) Detailed working instructions clearly specifying the zone of responsibility of each and every staff and supervisor along with temporary working instructions must be issued well in advance of the NI working. In any case these should be ready at least 15 days in advance of NI working.
- b) Station Master/AM Traffic who is overall in-charge should be fully aware of their responsibilities/duties. Temporary working instructions should clearly stipulate these unambiguously.
- c) Each Station Masters/Assist. Station Master, and other concerned staff deployed on shift duty should be supplied with copies of temporary working instructions.

- d) The temporary working instruction shall be supplied to SM/ASM in advance for study by them and for explaining to the staff working under him.
- e) The instruction should be prepared in Hindi, English and Vernacular language and assurance to the fact that they have understood shall be obtained.
- f) Readymade charts indicating normal and reverse position of points for specific routes must be prepared for each "goomty" . Modified working charts of all Signal and S&T assets must be prepared at least 15 days in advance.
- g) Compliance report must be submitted by Station Master at least 10 days in advance.
- h) These modified working charts must be printed, laminated and displayed in at each point of importance as mentioned in the chart and also given to each staff concerned.
- i) Draft instructions and modified working charts must be computerized and prepared in advance. Thereafter these should be revised on a day to day basis. Actual revision should take into account the progress of work as per the original time schedule.
- j) A checklist of items to be inspected jointly by Traffic, Signal and Permanent Way Supervisor should be drawn and controlling officers should monitor that instructions in the checklist are complied with.
- k) The exact location on the stock rail where clamps are to be fixed must be marked with white paint and clamps should actually be fitted to check that there are no obstructions.
- l) It may not be possible to fix clamps on motor operated points provided with second leading stretcher bar. In all such cases provision must be made for cotter bolting of points.
- m) In any case, cotter bolting of points must always be preferred as compared to clamping and padlocking since it is a much faster method.
- n) Normal/reverse position of points should be painted on tongue rail to indicate position of the road.

24.6.11 Mock Drill and Staff Assurance:

- a) Before the SM/ASM/Points man and other staff connected with train passing work are allowed independent duty, the Station Master shall obtain their verbal assurance that they have understood the same.
- b) With regard to station staff :
 - i) SM/AM Traffic should explain detailed working.
 - ii) Test their knowledge.
 - iii) Satisfy himself that they can work independently.
- c) Before starting actual non-interlocked working, a "mock drill" or "hands-on" demonstration/training should be given to all staff for at least 1 to 3 days in advance (depending on the size of the station) to familiarize them thoroughly with the type of work they have to handle.
- d) This should be carried out in all the 3 shifts to ascertain difficulties, if any, which may be encountered during NI working.
- e) Teams already formed for different shifts should be deputed as per roster.
- f) "Mock drills" should be carried out without actually disconnecting signal gears, points etc.

- g) Whatever deficiencies are noticed during this period should be rectified before introduction of actual NI. This experience should also be used to accurately estimate capacity to be available during N.I. and the number of trains planned to handled should be accordingly revised.
- h) Written assurances are required to be obtained before staff connected with train passing duties are allowed to work independently.
- i) This written assurance should be taken from the staff only after :
 - i) They have participated in the “mock drill”.
 - ii) Worked independently as per their laid down roster.
 - iii) Successfully carried out all responsibilities entrusted to them during the “mock drill”.
- j) No staff should be deployed unless proper entries are made in the “Assurance Register” and relevant signatures obtained.

24.6.12 Dissemination of information :

- a) All aspects of working during NI, and changes post-NI should be clearly documented and explained at all Loco pilot/Guard lobbies, whose staff pass through that yard or Interface.
- b) For this purpose crew supervisors, senior staff as deputed by DFCCIL will be nominated to visit these lobbies, with yard plans and camp at these lobbies.
- c) Assurance of each and every running staff regarding these changes should be recorded in respective lobby assurance registers, and complete report submitted to AGM/JGM Transportation ,Safety, Electrical, Mechanical, S&T and Civil on return.
- d) DFCCIL shall also pass on detailed program of NI working to all private train operators and Indian Railways for further dissemination in their concerned staff.
- e) All Train control staff should be appropriately briefed.
- f) The section controllers working at OCC must be fully conversant with the proposed changes pre-NI, restricted movement during the course of NI working and post-NI facilities to be made available.

24.6.13 Telecommunication, Lighting and Medical :

- a) Absolutely fail safe arrangements must be made regarding communication between the station and two adjoining stations on either side so that under no circumstances should there be a situation of total failure of communication between these stations.
- b) Satisfactory arrangements for telephonic communication between station (indoor), Cabins, temporary sheds, IMD/IMSDs (concerned) and Level Crossings Gates should be made to ensure efficient functioning of telephones provided at various locations.
- c) Additional fail safe communication between OCC and the NI station must be provided as a backup to existing section control channels.
- d) Loud speakers must be provided at suitable locations for making announcements regarding train movement.
- e) Walkie – Talkie sets must be provided to all supervisors working at site.

- f) Senior staff at block sections on either side of the NI station must be provided with walkie – talkie sets, electronic hand signal lamps etc.
- g) Arrangements of staff and recharging facilities should be available for charging of batteries of telecom equipment including walkie – talkies.
- h) General lighting in yard and Interface should be adequate.
- i) Separate lighting should be provided in each point zone. Lighting should be adequate so as to ensure that each modified S&T asset control is clearly visible to the ASM.
- j) Adequate generator backup should be provided. Spare bulbs should also be provided at each location.
- k) Round-the-clock medical post with doctor and para-medical staff must be provided. They should be equipped for handling first aid and crush injuries.

Anti-snake venom (Covalent) should be available. Road ambulance should be permanently stationed for quick transportation if needed.

24.6.14 Safety Equipment :

- a) Safety equipment required for each location such as level crossing gate etc. must be spelt out in detail and full complement arranged.
- b) Adequate spares must be arranged for safety equipment such as hand signal flags, detonators, , clamps and pad locks etc.
- c) LED based flashing Hand Signal Lamp must be provided to each such location for better visibility.
- d) Clamps & padlocks must be thoroughly tested to be in proper working condition.
- e) Adequate spares for each affected S&T asset, as prescribed by rules for such situations, must be kept in reach.
- f) Adequate arrangements for extra spares, lighting, safety clothing & gear, catering etc must be made at each affected S&T asset where a staff needs to be deployed during NI working

24.6.15 Security arrangements :

- a) Adequate security staff round the clock must be arranged at following locations :
 - i) SM's office.
 - ii) Central place at the station.
 - iii) Level crossing gates (if available)
 - iv) Any other location as may be deemed necessary.

24.6.16 Introduction of NI working :

- a) Before permitting introduction of NI working Executive Director-Corridor will satisfy himself regarding arrangement of staff, safety equipment, lighting, telecommunication and ground position.
- b) On the day of commencement of NI working, AGM/JGM from Operating, Safety, Civil, Signal, Electrical and Mechanical along with ED-Corridor will visit the place of work. They shall satisfy themselves of availability of necessary arrangement as per standard before permitting introduction of non-interlocking.

- c) On the notified day, for introduction of NI working, AM/Signal concerned shall give a general disconnection memo for gears proposed for NI working.

24.6.17 Train Operation during NI period :

24.6.17.1 Working of Signals:

- a) Speed restriction of 15 kmph. must be in force over all points and crossings. Speed restriction Board of 15 kmph must be exhibited at the foot of the first stop signal.
- b) A common NI home signal without route indicator should be provided with caution aspect.
 - i) NI Home/Starter signal can be taken off only after ensuring that all points on the route are correctly set, both facing and trailing points clamped and padlocked.
 - ii) Level crossing gates on the route have been closed against road traffic.
- c) Movement of trains to and from the block sections should be controlled by taking off the last stop signal.
- d) Normally, no Paper Line Clear should be issued to the loco pilots as authority to proceed in the block section.
- e) A traffic block of 2 – 3 hrs. should be taken for disconnecting the last stop signal and block instrument and reconnecting the new last stop signal and new block instrument.

24.6.17.2 Train Running:

- a) Trains must be allowed to enter cautiously at 15 kmph.
- b) Loco pilot of an incoming train must not under any circumstances pass the outermost facing points even though signals have been taken off unless a proceed hand signal is exhibited towards him from the points.

24.6.18 Failures :

- a) All indicative accidents during the period of NI working must be immediately reported to the site in charge in order to ensure prompt corrective action and avoidance in future.
- b) Details regarding such cases must be promptly intimated to ED-Corridor and AGM/JGM /Safety.
- c) A record must be kept for all S&T assets with modified working in which before handing over charge, staff will enter details of whatever difficulties they have faced during their shift. The person in charge of NI working at that station must scrutinize this record daily.
- d) Cases of bursting of NI target should be appropriately dealt with and individual responsibility should be fixed up.

24.6.19 Revised Station Working Rules :

- a) After completion of NI working, new works are to be commissioned.
- b) Since the yard layout, interface, facilities etc. have changed, the previous SWR is no longer valid.

- c) A new SWR duly approved by CRS is to be brought into effect after completion of NI.
- d) Staff assurances for the revised SWR must be taken afresh.

24.6.20 Completion of NI Working:

- a) NI working must not be terminated unless and until each and every item originally scheduled for completion has been successfully complied with.
- b) Designated operating officer must visit the NI station and verify the following:
 - i) Completion of work as per program.
 - ii) Correspondence of yard/interface layout as per new SWR.
 - iii) Correspondence of movements permitted as per new SWR.
- c) The installation shall jointly be tested by Transportation, S&T and Engg. officials and for their correct functioning.
 - i) The S&T asset including its points and connections should work freely and properly and that the installation fulfils its objective.
 - ii) Signals are properly focussed; the indications on the panel correspond with the signal aspect and point position at site.
 - iii) Engineering officials shall check the proper housing of various modified assets etc.
- d) Before issue of Safety certificate and taking over of stations, the Station Master shall instruct the station staff responsible or working the interlocking installation and test them in their knowledge of the signalling arrangement.
- e) Engineering and S&T officers shall give a certificate stating that all works as per the approved plan are completed.
- f) Staff concerned shall be notified through Station Order Book, Control Order Book and their acknowledgement obtained. All supervisors shall ensure strict compliance and report any deviation or violation with prompt to notify them and there.
- g) On the day of completion of work, Branch Officers concerned shall visit the work site to ensure completion of work as per program.

24.6.21 Post NI analysis :

- a) Within 7 days of completion of NI, a brain storming session should be held with all the senior supervisors involved for taking stock of lessons learnt.
- b) These lessons learnt should be compiled at one place for successive NIs, so that they are available for future reference.
- c) A copy of the same may also be sent to other corridors and Headquarters for reference purposes.

25. System of Interlocking

1. Interlocking: - Interlocking means an arrangement of Signals, Points and other gears, operated from a Panel, so inter-connected by Electrical/Electronic locking that their operation must take place in proper sequence to ensure safety.
2. The Essentials of Interlocking are:-
 - (a) It shall not be possible to take off a running signal, unless all points including isolation are correctly set, all facing points are locked and all interlocked level crossings are closed and locked against public road for the line on which the train will travel, including the overlap.
 - (b) After the signal has been taken off, it shall not be possible to move any points or lock on the route, including overlap and isolation, nor to release any interlocked gates until the signal is replaced to "ON" position.
 - (c) It shall not be possible to take "OFF" at the same time, any two fixed signals which can lead to any conflicting movements and
 - (d) Where feasible points shall be so interlocked as to avoid any conflicting movement.
3. Electronic Interlocking (EI)

Electronic Interlocking (EI) system is a microprocessor based interlocking equipment to read the yard and panel inputs; process them in a fail-safe manner as per selection table and generate required output. This system is the alternative to the conventional Relay Interlocking system (PI & RRI). Unlike PI or RRI, Microprocessors (IC'S) are doing the Interlocking based on pre-determined logic circuits.

Advantages of EI:-

- No relays are required for interlocking function. Only interface relays are required.
- Space requirement is reduced substantially.
- Reduction in power consumption.
- Reduction in wiring, interconnections and no. of fuses
- More reliability and safety due to less relays and accessories.
- Self-diagnostic features. Any failure in the system is located and enunciated. Faulty module can be immediately replaced by spare module hence the down time of installation is reduced.
- Less prone to short cut method, total system goes to shut down if even if wrong feed comes across.
- Alteration due to yard remodelling does not require any wiring change, only data of the CPU card is required to be changed. Hence, yard remodelling does not require large scale alterations and can be carried out in less time.

4. OPERATIONAL PROCEDURE OF VDU (Video Display Unit)

The below procedure for operation of VDU is for purpose of explanation only. There may be variations based on OEM's design of Electronic Interlocking. For details of any particular EI system installed at any station, the Station Working Rules (SWR) of that stations may be referred.

4.1 Route Setting & Signal (Main, Calling ON and Shunt Signals)

"Signal S2" and "DZ" exit spot button are taken as an example and the control sequence is same for all routes.

First click on S2 Signal entry spot button (placed near S2 signal). After pressing the S2 entry spot button, click on DZ exit spot button. Then by clicking SET button, route set command is transmitted to EI.

If the interlocking conditions are satisfied, EI sets the route and signal is cleared. The corresponding route set and signal clear indication are updated on EI terminal screen.

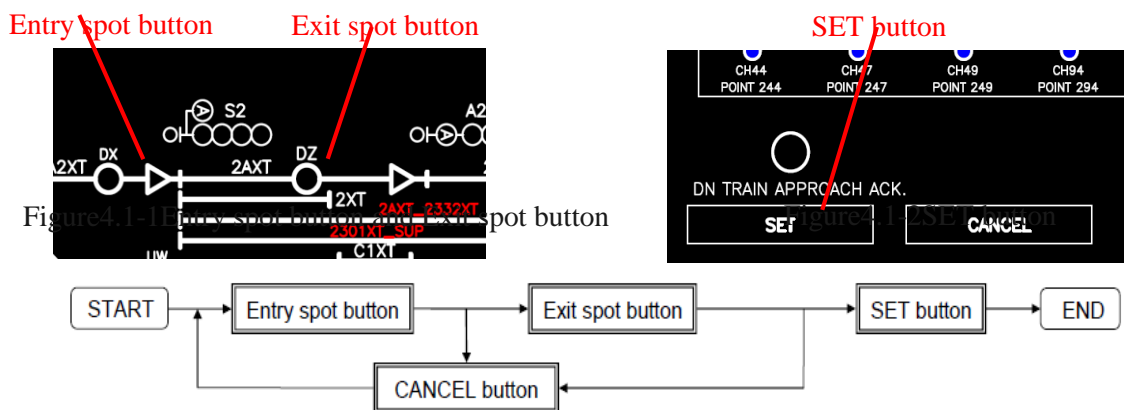

Figure4.1-3 FLOW OF ROUTE SETTING (1)

If some signals stand on same signal pole, kind of signal shall be selected after clicking entry spot button. Pop up menu comes up by clicking entry spot button. User can select kind of signal to be set.

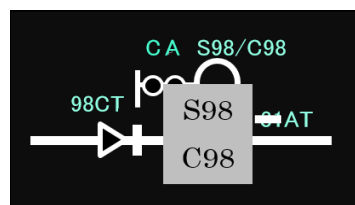

Figure4.1-4 ROUTE NAME SELECT

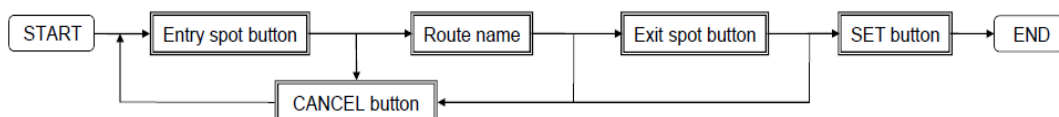

Figure4.1-5 FLOW OF ROUTE SETTING (2)

4.2 Signal Cancel

"Signal S1" is taken as an example and the control sequence is same for all other signals.

First click on EGSB button. After pressing the EGSB button, click on S1 entry spot button (placed near S1 signal). Then by clicking SET button, signal cancel command is transmitted to EI.

After a signal cancel operation, a cleared signal will be put back to red. The corresponding signal cancel indication will be updated on EI terminal screen.

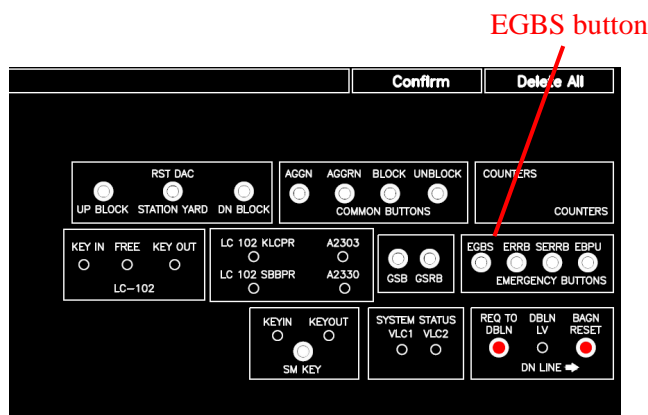

Figure 4.2-1 EGSB BUTTON

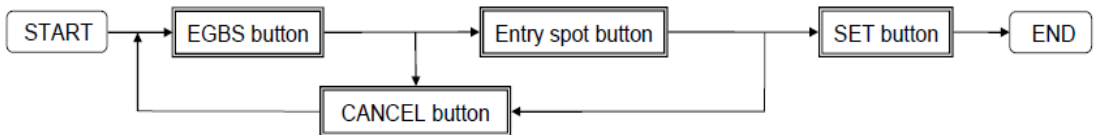

Figure 4.2-2 FLOW OF SIGNAL CANCEL

4.3 Emergency Full Route Release

"Signal S1" is taken as an example and the control sequence is same for all other signals.

First click on ERRB button. After pressing the ERRB button, password and user name input is required in password dialogue. And, click on S1 entry spot button (placed near S1 signal). Then by clicking SET button, emergency full route release command is transmitted to EI.

After an emergency full route release operation, track sections will be released. The corresponding track section indication will be updated on EI terminal screen.

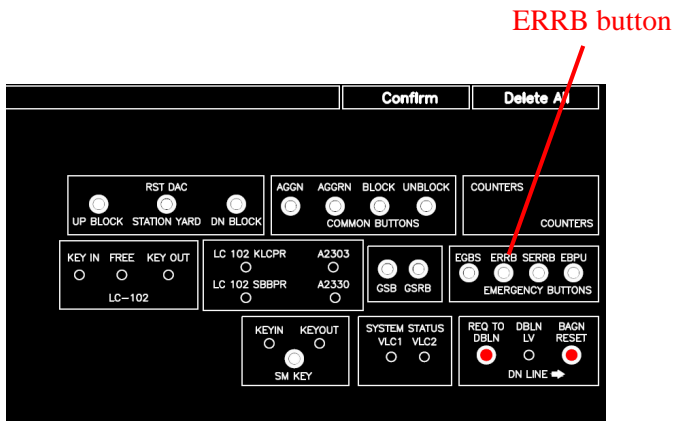

Figure 4.3-1 ERRB BUTTON

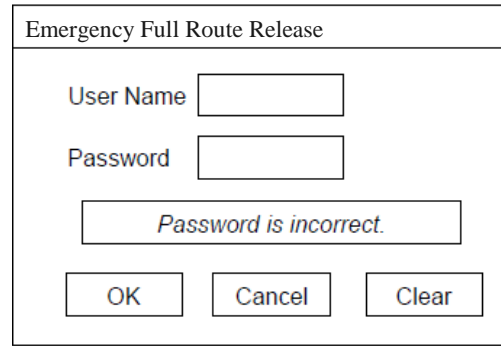

Figure 4.3-2 PASSWORD DIALOGUE

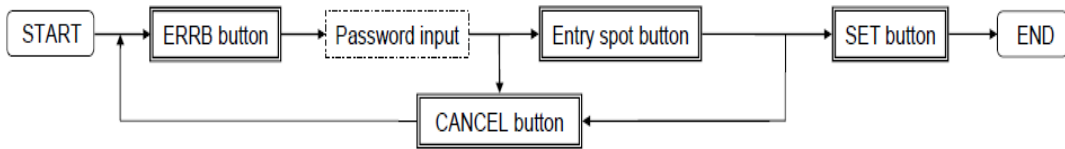

Figure 4.3-3 FLOW OF EMERGENCY FULL ROUTE RELEASE

4.4 Emergency Sub Route Release

"Signal S1" is taken as an example and the control sequence is same for all other signals.

First click on SERRB button. After pressing the SERRB button, password and user name input is required in password dialogue. And, click on track section.

Then by clicking SET button, emergency sub route release command is transmitted to EI.

After an emergency sub route release operation, track sections will be released. The corresponding track section indication will be updated on EI terminal screen.

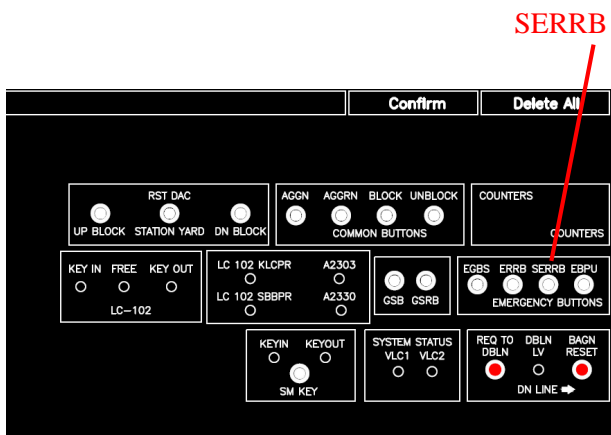

Figure 4.4-1 SERRB BUTTON

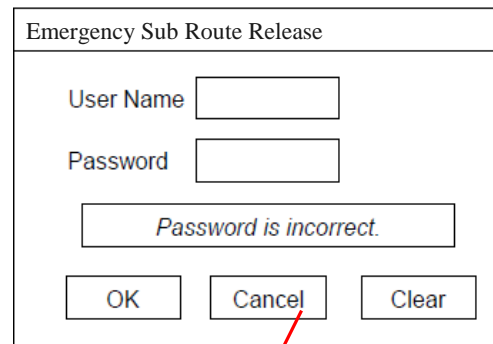

Figure 4.4-2 PASSWORD DIALOGUE

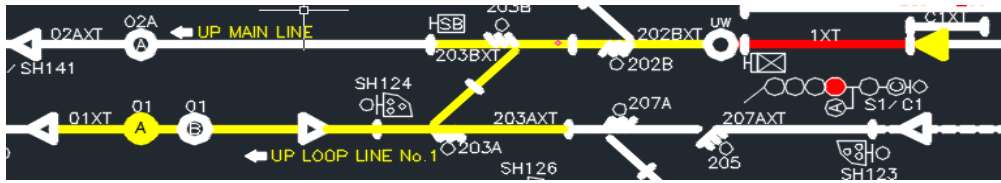

Figure 4.4-3 TRACK SECTION SELECT

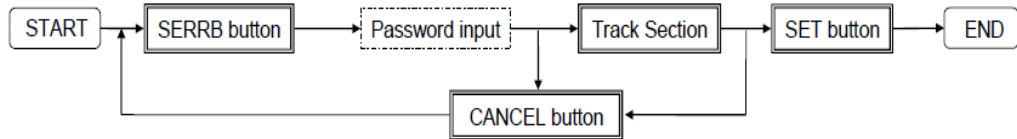

Figure 4.4-4 FLOW OF EMERGENCY SUB ROUTE RELEASE

4.5 Point Operation

“Point 202” is taken as an example and the control sequence is same for all other points.

First, click on "Point symbol". After pressing "Point symbol", select open direction on pop up menu. Then by clicking SET button, normal point operation command is transmitted to EI.

If the interlocking conditions are satisfied, EI sets the point. The corresponding point indication is updated on EI terminal screen.

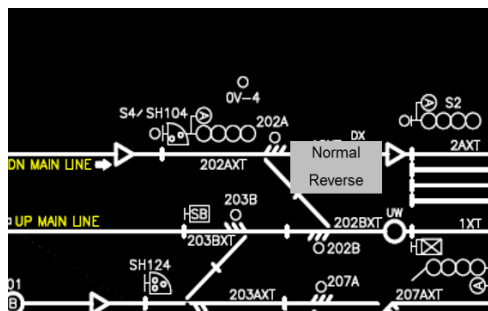

Figure 4.5-1 POINT SYMBOL SELECT

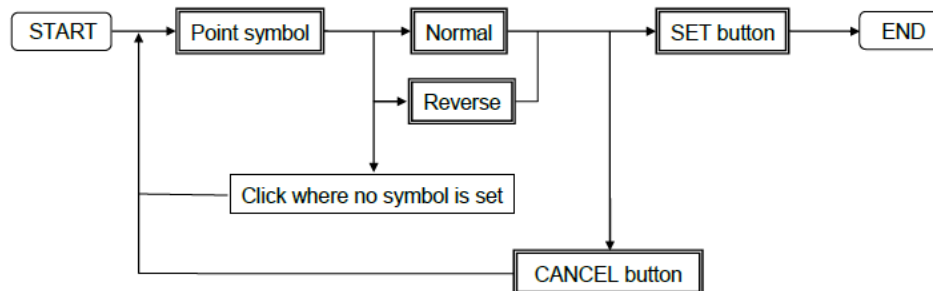

Figure 4.5-2 FLOW OF POINT OPERATION

4.6 Emergency Point Operation

"Point 202" is taken as an example for emergency point operation and the control sequence is same for all other points.

First, click on "EBPU" push button. After pressing EBPU button, password and user name input is required in password dialogue. Click on "Point symbol" and select open direction on pop up menu. Then by clicking SET button, emergency point operation command is transmitted to EI.

If the interlocking conditions are satisfied, EI sets the point. The corresponding point indication is updated on EI terminal screen.

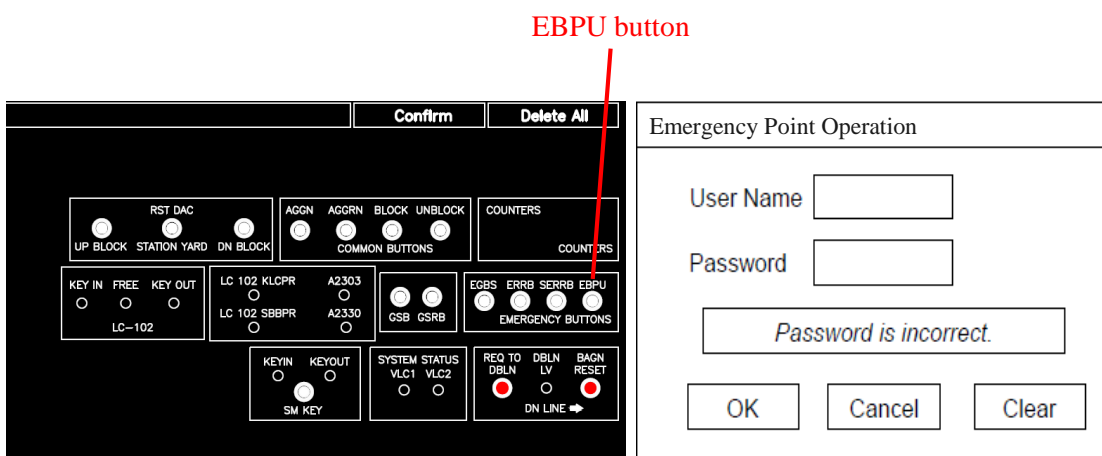

Figure 4.6-1 EBPU BUTTON

Figure 4.6-2 PASSWORD DIALOGUE

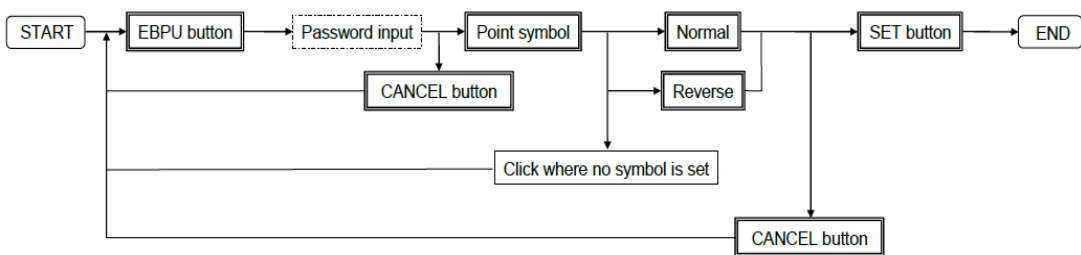

Figure 4.6-3 FLOW OF EMERGENCY POINT OPERATION

4.7 Crank Handle/ LC Gate Operation

"Crank Handle CH2" is taken as an example and the control sequence is same for all other crank handles.

First click on GSB button. After pressing the "GSB" button, click on CH1 symbol. Then by clicking SET button, crank handle operation command is transmitted to EI. In case of cancel of crank handle operation, first click GSRB button instead of GSB button.

If the interlocking conditions are satisfied, EI releases crank handle.

Similarly, the release control from "LC Gate" can be given as explained for Crank Handle operation.

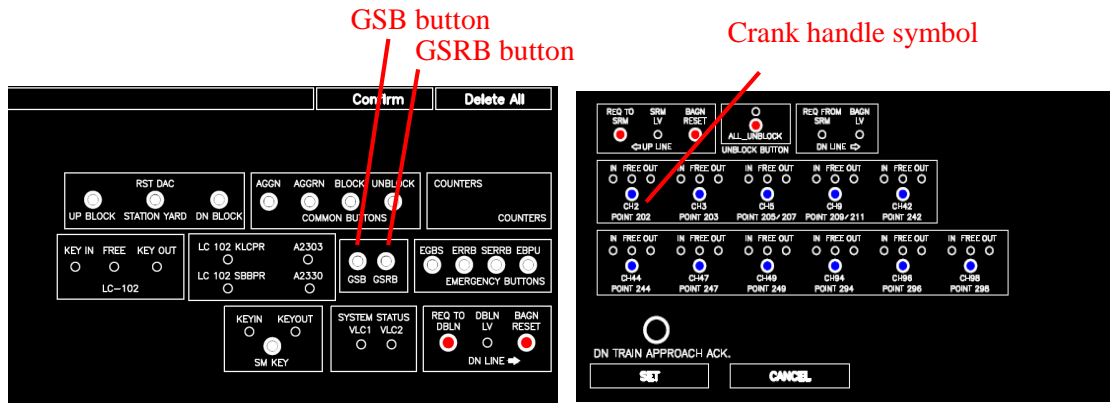

Figure 4.7-1 GSB BUTTON, GSRB BUTTON

Figure 4.7-2 CRANK HANDLE SYMBOL

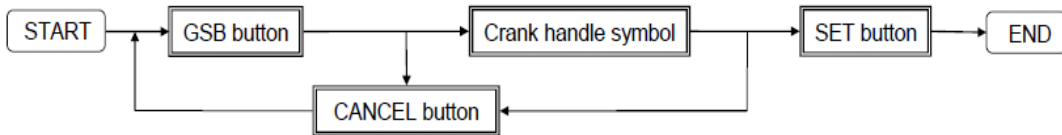

Figure 4.7-3 FLOW OF CRANK HANDLE OPERATION (set)

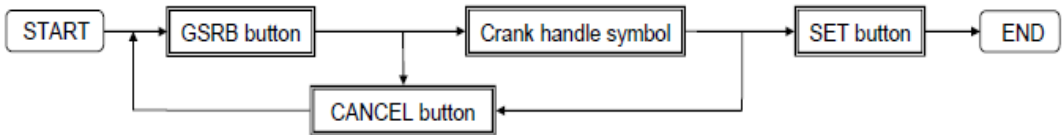

Figure 4.7-4 FLOW OF CRANK HANDLE OPERATION (cancel)

4.8 Auto Signal Set/ Reset Operation

"S2" Signal button is taken as an example and the control sequence is same for all routes.

First click on AGGN button. After pressing the "AGGN" button, click on S2 entry spot button. Then by clicking SET button, A/ AG marker set operation command is transmitted to EI.

In case of reset A/ AG marker operation, first click AGGRN button instead of AGGN button.

If the interlocking conditions are satisfied, EI sets A/ AG marker.

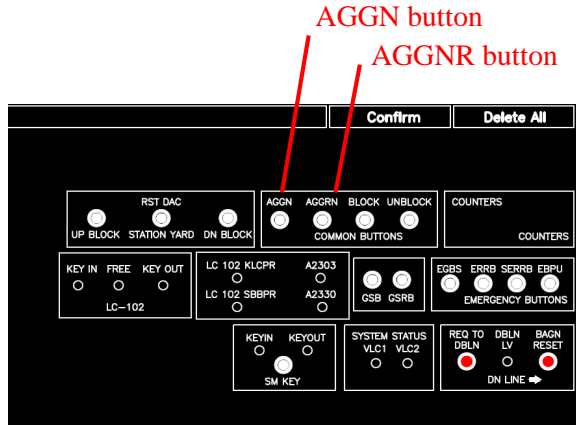

Figure 4.8-1 AGGN BUTTON, AGGNR BUTTON

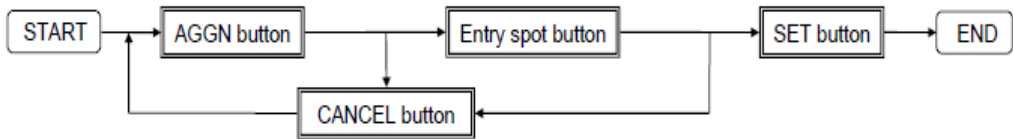

Figure 4.8-2 FLOW OF A/ AG Marker Set OPERATION

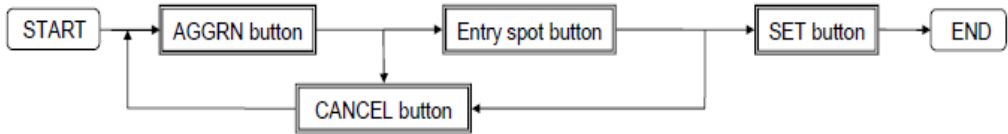

Figure 4.8-3 FLOW OF A/ AG Marker Reset OPERATION

4.9 All Unblock

Only click on All Unblock button, all blocking in initial EI start up is unblocked.

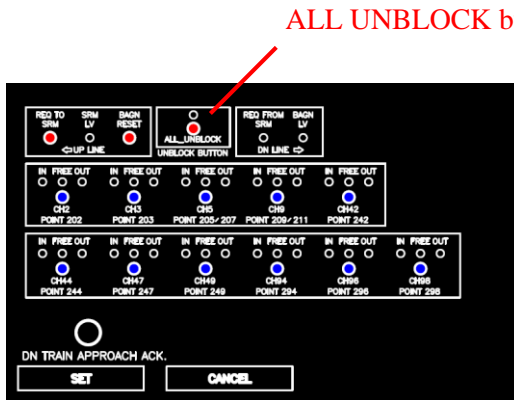

Figure 4.9-1 ALL UNBLOCK BUTTON



Figure 4.9-2 FLOW OF ALL UNBLOCK OPERATION

4.10 Signal Block/ Unblock

"S1" is taken as an example and the control sequence is same for all routes.

First click on BLOCK button. After pressing the BLOCK button, click on S1 entry spot button (placed near S1 signal). Then by clicking SET button, signal block command is transmitted to EI. In case of unblocking, click on UNBLOCK button instead of BLOCK button. And after pressing UNBLOCK button, password and user name input is required in password dialogue.

After a signal block operation, S1 exit spot button will be put back to red.

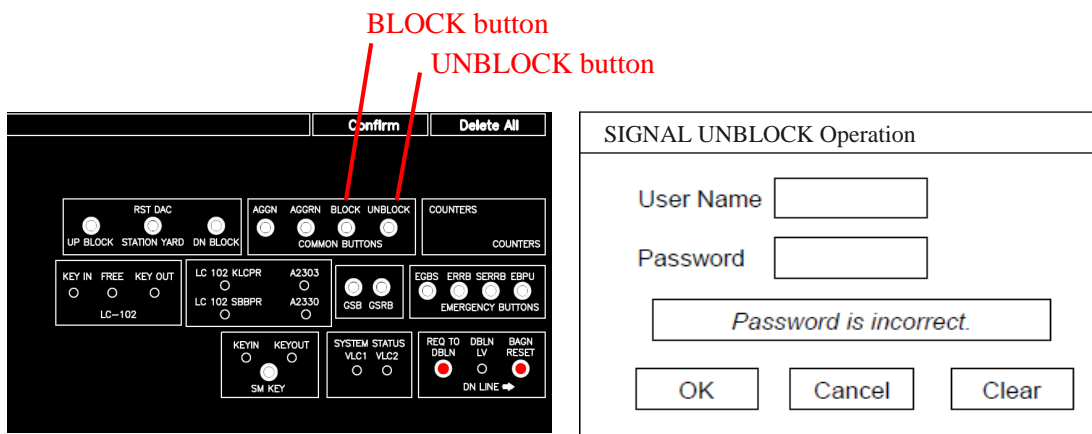

Figure 4.10-1 BLOCK BUTTON, UNBLOCK BUTTON

Figure 4.10-2 PASSWORD DIALOGUE

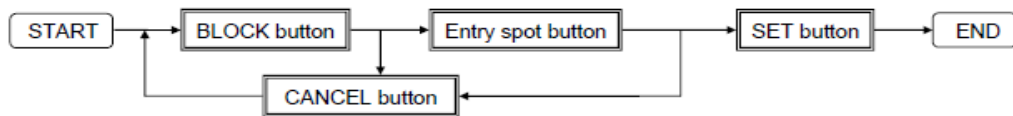

Figure 4.10-3 FLOW OF SIGNAL BLOCK OPERATION

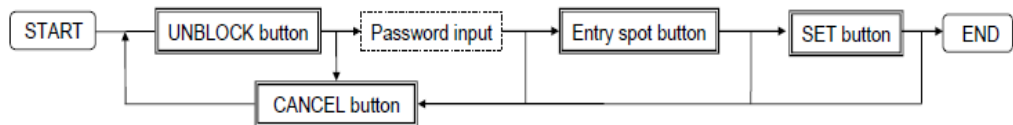

Figure 4.10-4 FLOW OF SIGNAL UNBLOCK OPERATION

4.11 Point Block/Unblock

"Point 202" is taken as an example and the control sequence is same for all routes.

First click on BLOCK button. After pressing the BLOCK button, click on point 202 signal symbol. Then by clicking SET button, point block command is transmitted to EI. In case of unblocking, click on UNBLOCK button instead of BLOCK button. And after pressing UNBLOCK button, password and user name input is required in password dialogue.

After a point block operation, point symbol will be put back to red.

POINT UNBLOCK Operation

User Name

Password

Password is incorrect.

Figure 4.11-1 PASSWORD DIALOGUE

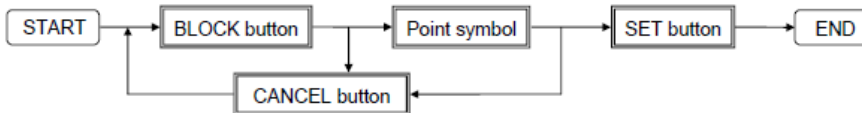

Figure 4.11-2 FLOW OF POINT BLOCK OPERATION

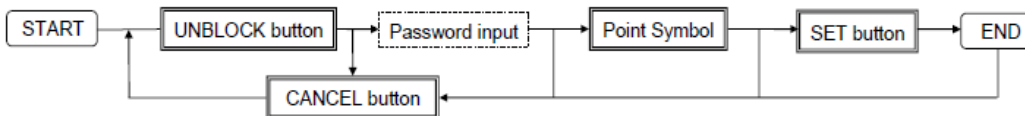

Figure 4.11-3 FLOW OF POINT UNBLOCK OPERATION

4.12 DAC Reset Operation

"Track Section 101AXT" is taken as an example and the control sequence is same for all track sections.

First click on LVB button on site. While pressing LVB button, track section name of 101AXT coloured in yellow. While pressing the LVB button, click on STATION YARD button. And, click on Track Section button. Then by clicking SET button, point block command is transmitted to EI. After pressing SET button, track section name of 101AXT coloured in green as preparatory mode. In case of block section, click on UP or DN button instead of STATION YARD button.



Figure 4.12-1 LVB PRESSING INDICATION



Figure 4.12-2 PREPARATORY MODE INDICATION

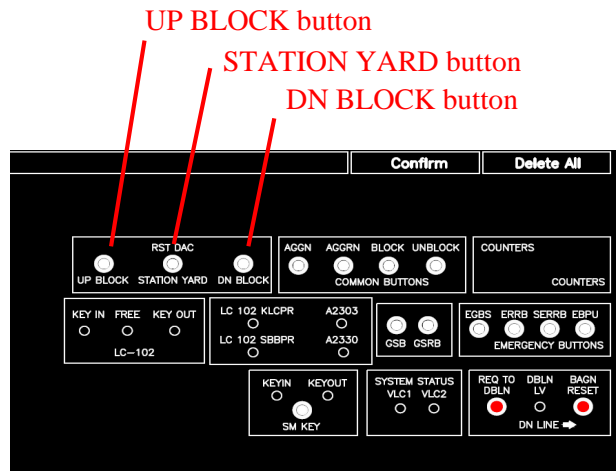

Figure 4.12-3 STATION YARD BUTTON, UP/ DN BLOCK BUTTON

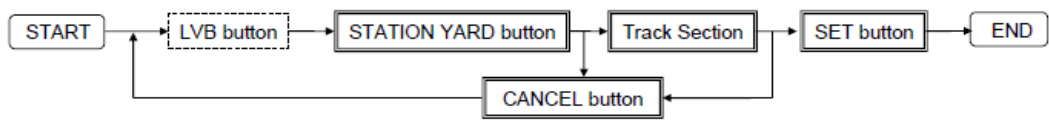

Figure 4.12-4 DAC RESET OPERATION (STATION YARD)

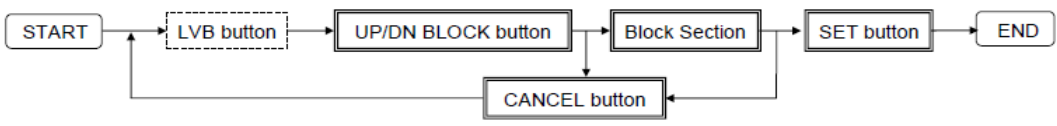

Figure 4.12-5 DAC RESET OPERATION (BLOCK SECTION)

4.13 SM key In/ Out Operation

First, click on "SM KEY" button. After pressing SM KEY button, password and user name input is required in password dialogue. Then by clicking SET button, SM key in/ out operation command is transmitted to EI.

The corresponding indication is updated on EI terminal screen.

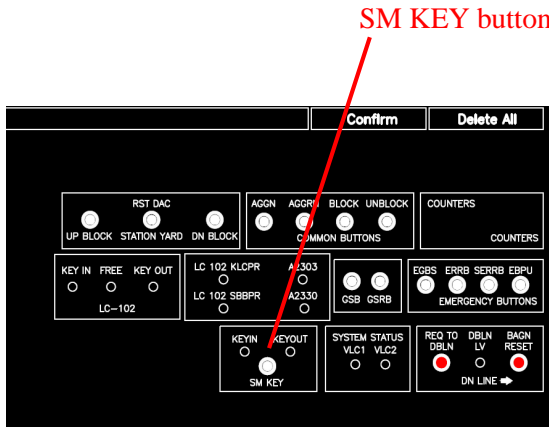

Figure 4.13-1 SM KEY BUTTON

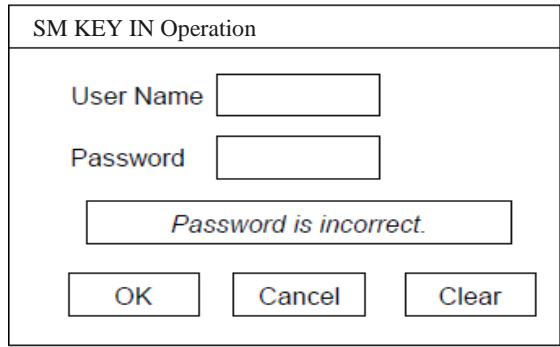

Figure 4.13-2 PASSWORD DIALOGUE

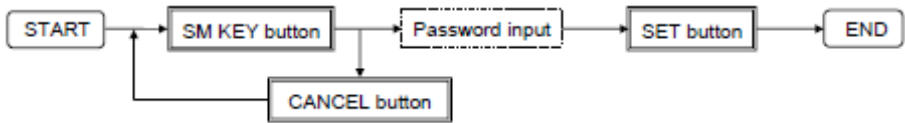

Figure 4.13-3 FLOW OF SM KEY IN/ OUT OPERATION

4.14 Slot Working Set/ Reset Operation

First click on GSB button. After pressing the "GSB " button, click on Slot button. Then by clicking SET button, slot working set operation command is transmitted to EI.

In case of slot working reset operation, first click GSRB button instead of GSB button.

If the interlocking conditions are satisfied, EI operates slot working set/ reset.

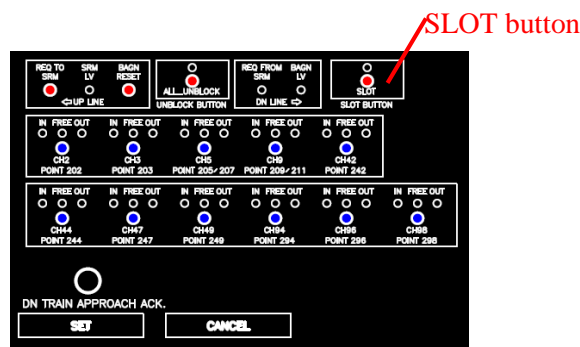

Figure 4.14-1 SLOT BUTTON

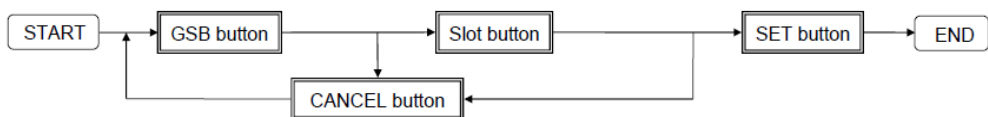

Figure 4.14-2 SLOT WORKING SET OPERATION

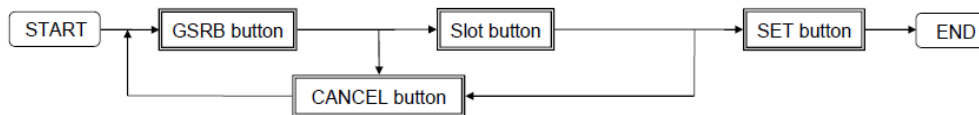

Figure 4.14-3 SLOTT WORKING RESET OPERATION

4.15 The following COUNTERS are provided on VDU.

i) CALLING ON SIGNAL COUNTER (COGGN)

This counter advances by one digit for every operation of 'Calling-ON' signal.

ii) EMERGENCY ROUTE CANCELLATION COUNTER (EUYN)

This counter advances by one digit, for every operation of emergency cancellation route of the signal.

iii) EMERGENCY ROUTE RELEASE COUNTER (EUUYN)

This counter advances by one digit, for every operation of emergency release of route of the signal.

iv) EMERGENCY POINT OPERATION COUNTER (EWN)

This counter advances by one digit for every emergency operation of the point.

v) EMERGENCY SIGNAL REPLACEMENT COUNTER (EGRN)

This counter advances by one digit for every emergency replacement of signal to normal position.

vi) EMERGENCY OVERLAP RELEASE COUNTER (OYN)

This counter advances by one digit for every emergency overlap release.

NOTE:- Separate registers shall be kept for recording the operation of each counter or alternatively separate set of pages may be earmarked in the register for every counter.

26. System of Communication

1. PBX based Telephone Network

- 1.1 A main and satellite PBXs based Telephone Network shall be installed. Main PBX shall be provided at OCC, while Satellite PBXs shall be provided at all Stations.

2. Direct Line Telephone Network

- 2.1 The Direct Line Telephone Network shall provide instant, non-blocking & uninterrupted communication between key strategic points, which shall include, but not be limited to:

- (i) **Train Traffic Control Communication:** This is provided for communication with one-touch button selective calling facility between the Traffic Controller in the OCC and Station Controller (SC) at Stations, IR Sectional Control Centres along the DFC Route, Depot Control Rooms, Crew Control Rooms, and other important locations along the route, for the control of train movements and effective utilization of section capacity.
- (ii) **Traction Power Control Communication:** This is provided for communication with one-touch button selective calling facility between Traction Power Controller in the OCC, Station Controller at Stations, Switching/Feeding Posts of Traction Power to the Overhead Alignment and Maintenance Staff Rooms at wayside locations.
- (iii) **Engineering Control Communication:** This is provided for communication with one-touch button selective calling facility between OCC and important Civil Engineering maintenance and work related locations along the track.
- (iv) **S&T Control Communication:** This is provided for direct line communication with one-touch button selective calling facility between OCC and important S&T maintenance and work related locations along the track.
- (v) between adjacent Station Control Rooms for stations with one-touch button dialling;
- (vi) between Station of DFCC and Interfacing Station Master Room of Indian Railway with one-touch button dialling;
- (vii) between LC Gates and Station Control Rooms of adjacent stations with one-touch button dialling; and
- (viii) between Depot Control Rooms and Station Control Rooms of adjacent stations with one-touch button dialling.

2.2 Direct Line Console:

- (i) Direct Line Consoles shall be provided for Assistant Controller and Traffic Controller at OCC.
- (ii) Direct Lines Consoles shall be provided for Chief Controller, Deputy Chief Controller, Traction Power Controller, Signalling Fault Management Controller and Track Controller.
- (iii) Direct Line Consoles shall be provided for Station Controllers in SCR of each Station.
- (iv) The Direct Line Console shall provide selection facilities in the form of push button and/or soft keys with visual display unit for user to perform, but not be limited to, the following functions as a minimum:
 - (a) originate outgoing calls to the selected user;
 - (b) select and answer any incoming calls destined for the Direct Line Telephone Console;
 - (c) originate outgoing calls to a pre-defined group of users;
 - (d) originate outgoing calls to a group or all users defined by the Direct Line Telephone Console at the time before the call is placed;
 - (e) make conference calls to add additional users to an established call connection;
 - (f) patch calls or put through two individual users for call connection;
 - (g) transfer call to PBX extension; and
 - (h) make and receive emergency call (override facility).
- (v) The Direct Line Console shall be equipped with, but not be limited to, the following facilities:
 - (a) handset;
 - (b) push button or soft key for each Direct Line Telephone;
 - (c) 12-push button keypad for dialling;
 - (d) adjustable volume control for speaker and ringer;
 - (e) hands-free operation through built-in speaker and microphone;
 - (f) powered by the Central communications processor;
 - (g) visual display of details for incoming and outgoing calls;
 - (h) display of call duration;
 - (i) system clock display;
 - (j) lamp for message waiting;
 - (k) lamp for ringing signal; and
 - (l) transmit DTMF signal when call has been connected.
- (vi) The Direct Line Communication System shall support a minimum of 8 simultaneous incoming calls to the Direct Line Console to be queued before

these calls are answered. The identity of the calling parties in the queue shall be displayed on the Direct Line Console in ascending order of the incoming sequence. Console Controller shall be able to answer calls in queue in any sequence. Call answered shall be removed immediately from the display.

- (vii) The selection facilities of the Direct Line Console, in the form of physical push button and/or soft key, shall be labelled with identity of the called party or functions of the selection facilities.
- (viii) The selection facilities shall provide selection status indication in the form of LCD or LED displays.
- (ix) Dedicated push button and/or soft keys shall be assigned to each telephone line which can be connected to the Direct Line Telephone/Console.
- (x) At least 10 spare push buttons and/or soft keys shall be provided for assignment of additional functions or Console/Telephone.
- (xi) The push buttons and/or soft keys of similar functions or nature shall be grouped together to facilitate the user to locate the required selection.
- (xii) The Direct Line Console shall also be provided with functions for operation as an ordinary telephone set. The Direct Line Console shall be equipped with keypad for dialling to originate administrative telephone network call and support on-hook dialling.
- (xiii) The Direct Line Console shall give different audio and visual indication for normal and emergency calls.

2.3 Indian Railway Telephone Network shall be integrated with Direct Line Communication System, so that one touch dialling can be done from Direct Line Console to important Operation Locations of Indian Railway.

2.4 Public Switch Telephone Network (PSTN) Lines shall also be integrated with Direct Line Communication System, so that one touch dialling can be done from Direct Line Console to Electric Power Companies, Emergency Services etc.

2.5 Direct Line Telephones:

- (i) Direct Line Telephone shall be provided in the other locations such as IR Sectional Control Centre, Interfacing Station Master Room of IR, LC Gates, Crew Control Rooms, Depot Control Rooms, Switching/Feeding Posts, TPC Maintenance Staff Rooms, Important Civil Engineering Maintenance & Work related Locations and Important S&T Maintenance & Work related Locations etc., to meet the desired communication requirement.
- (ii) It shall be possible from Direct Line Telephone to make normal and emergency direct line calls to the designated controllers in OCC. Different audio and visual

indications shall be provided for incoming direct line calls on the Direct Line Consoles or Direct Line Telephone for normal and emergency calls.

3. Control Communication System on omnibus voice channel

3.1 Control Communication System shall be provided to meet omnibus voice communication requirement of Train Traffic Control.

3.2 This is provided for communication with one-touch button selective calling facility between the Traffic Controller in the OCC and Station Controller at Stations, IR Sectional Control Centres along the DFC Route, Depot Control Rooms, Crew Control Rooms, and other important locations along the route.

4. Emergency Communication through Portable Control Telephone

Emergency Control Communication which is an omnibus communication channel terminating at OCC with the Traction Power Controller shall be provided. This Emergency Control Communication shall not have selective calling facility. Emergency Control Communication shall have Emergency Sockets as per IR Standards for RE Areas at all the Automatic Signals to which this omnibus communication channel is terminated. The Portable Telephone of IR Standard for RE Areas which will be carried by the crew, can be plugged in case of emergency. This Emergency Control Communication channel can be switched to the other controllers by the Traction Power Controller. For better availability, two emergency control communication channel shall be provided, one terminating on the signal posts of Up track and the second one terminating on the signal posts of Down track.

5. VHF Transceivers

5.1 25 Watt VHF Transceivers shall be installed in Station Control Room and any other specified place. Omni-Directional Antenna for 25 Watt VHF Transceivers shall be mounted on a suitable Pole/Mast at a height of 15 meters from the ground level.

5.2 Provision of Voice Recording of conversation taking place on 25 Watt VHF Transceivers shall be provided through Voice Recording Equipment. This recording shall be Date and Time Stamped along with Stamping of Station Identity and VHF Channel Identity. Storage of Voice Communication shall follow FIFO (First-In-First-Out) methodology. There shall be an Ethernet Interface Port through which Recorded Voice can be transferred to Laptop for replay or taking backup on CD/DVD. It shall be able to replay the Voice Recordings by simple operation of some feature/function key.

5.3 5 Watt walkie-talkie sets are provided for point to point communication.

6. Mobile Train Radio communication

6.1 Mobile Train Radio communication is a digital wireless network based on GSM-R (Global System for Mobile Communication-Railway) designed on EIRENE (European Integrated Railway Radio Enhanced Network) Functional requirement specification (FRS) and System Requirement specification (SRS).

6.2 To meet the operational and maintenance requirements, MTRC system based on GSM-R shall support the following services:

- Voice services:

- point-to-point voice calls;
- public emergency calls;
- broadcast voice calls;
- group voice calls;
- multi-party voice calls;

- Data services:

- text message bearer service;
- bearer service for general data applications;
- bearer service for automatic fax;
- bearer service for train control applications;

- Call related services:

- closed user group;
- multi-level priority and pre-emption;
- advanced call handling, such as call hold, call transfer, call queuing, etc;
- auto answer service;
- barring incoming or outgoing calls;
- call supervisory indications;
- charging information;

- Railway specific applications:

- support for functional addressing by train, engine or coach number or functional number;
- call specific persons depending upon user location;
- specific mode for shunting operations providing a link assurance signal;
- multiple driver communications within the same train;
- railway operational emergency calls;

- Direct mode facility for local set-to-set operation without network infrastructure;

- Railway specific features:

- set-up of urgent or frequent calls through single keystroke or similar;

- display of functional identity of calling/called party;
- fast and guaranteed call set-up;
- seamless communication support for train speeds up to 500 km/h;
- automatic and manual test modes with fault indications;
- control over mobile network selection;
- control over system configuration.

6.3 Types of Radio:-

S.No.	Radio Type	Description
1	Cab Radio/ Fixed Radio Terminal	The radio and associated user and other interfaces installed in the cab of a locomotive/Station Master room and for use of principally by the locomotive driver/ Station Master. The driver/ Station Master man-machine interface of Radio shall comprise of the display, control panel, loudspeaker and handset.
2	General Purpose Radio (GPH)	A standard radio closely based on commercially available units for general use. The man-machine interface of General Purpose Radio shall comprise of the display, control panel, loudspeaker and microphone.
3	Operational Radio (OPH)	A handheld radio suitable for use by people involved in railway operations. The man-machine interface of Operational Radio shall comprise of the display, control panel, loudspeaker and microphone.
4	Shunting Radio	A handheld radio suitable for use by people involved in railway operations including shunting operations.

6.4 Radio Dispatcher Console (Controllers Equipment)

The functionalities required by different controllers in Radio Dispatcher Consoles are essentially same, but the control area and their configuration will differ. Radio Dispatcher Consoles shall be provided with following minimum functionalities:

- (i) Queue all incoming calls or call request showing the functional identity and priority of caller.
- (ii) Emergency call shall be identified and presented on top of all calls in the queue and shown in different colour/flashing followed by calls in order of priority.

- (iii) Allow the controller to select any of the calls from the queue in any order he likes.
- (iv) Allow the controller to establish railway emergency call or railway operation priority call to any mobile by selection from the display.
- (v) Allow the controller to make, close, enter and leave group calls.
- (vi) Allow the controller to send and receive text messages.
- (vii) Transfer its call to another Radio Dispatcher Consoles.
- (viii) If a railway emergency call is not answered it shall automatically be transferred to the Chief Controller or any other controller's console.
- (ix) The Chief Controller shall have the provision of taking over the functions of any of the Traffic Controllers in their absence.

6.5 Railway Emergency Calls

6.5.1 Railway Emergency Calls is the highest priority group call in GSM(R) based Mobile Train Radio Communication (MTRC) system which can be initiated by a Mobile radio user in case of any Railway Operational Emergency and is routed to pre-defined users i.e. Train Drivers, Station Masters & other Railway Personnel related to Operations, located within a specified geographical area from where the Emergency call has been initiated including Traffic Controllers.

6.5.2 There are two types of Railway emergency call:

- (i) Train emergency call;
- (ii) Shunting emergency call.

The type of call initiated shall be determined automatically, based upon the mode of operation of the radio. If the mobile is in shunting mode, the emergency call button shall initiate a shunting emergency call, otherwise the call shall be a Train emergency call.

Train emergency call

The Train emergency call shall be sent to all drivers and controller(s) within an area, which is pre-defined to meet operational requirements. The predefined areas for emergency calls shall include, where necessary, parts of one or more network(s).

Shunting emergency call

The Shunting emergency call shall be sent to all users involved in shunting operations in the shunting area.

6.6 A Railway emergency call may be defined in three distinct phases. These are:

- Stage 1: Warning;
- Stage 2: Information;
- Stage 3: Terminate Railway emergency call.

6.6.1 Stage 1: Warning

- (i) A Railway emergency call shall be able to be initiated by using a simple MMI action (eg a single MMI action for the Cab and Operational radios).
- (ii) A connection of Railway emergency priority shall be established to a pre-determined set of receiving mobiles and controller(s).
- (iii) If the system is not able to connect the call, the system shall automatically keep trying to connect the call for 30 seconds.
- (iv) During this period the user shall be provided with an audible and visual indication that the system is trying to connect the call.
- (v) After the 30 second period, if the connection was unsuccessful, the system shall provide another audible and visual indication that it was unable to connect the call.
- (vi) An audible indication of 5 seconds shall be provided to originating and receiving users that the emergency function has been activated.
- (vii) Different indications at the originating and receiving terminal may be provided.
- (viii) A continuous visual indication that the emergency function has been activated shall be provided at the originating and all receiving terminals.
- (ix) In the event that a train enters the affected area after the warning stage is complete, the same audible and visual indications shall be provided.

6.6.2 Stage 2: Information

- (i) A speech connection shall be established immediately following the warning tone, to allow the originator of the emergency call, to give information concerning the nature of the emergency.
- (ii) Speech should be possible to allow a controller receiving the warning tone to give information.
- (iii) Additionally, speech should be possible to allow other mobile users receiving the warning tone to give information.
- (iv) The information shall be received by the same set of users who received the warning tone.

6.6.3 Stage 3: Terminate Railway emergency call

- (i) A Railway emergency call may only be terminated by:
 - the originator of the call;
 - a controller participating in the call;
 - the network following a (nationally determined) period of no speech.
- (ii) If the radio moves out of the area whilst the emergency call is in progress, an audible and visual indication of the loss of the call shall be provided to the user.

6.7 Receipt of Railway emergency calls

- (i) Authorised mobiles shall be able to receive a Railway emergency call at any time while the mobile is powered up.
- (ii) For Railway emergency calls initiated by a mobile, the controller's display will indicate:
 - location;
 - the functional identity of the originating mobile, which includes the following:
 - the train number, if allocated;
 - the engine number, if no train number is available;
 - the coach number of the leading cab, if neither a train number nor an engine number is available.

6.8 Confirmation of Railway emergency calls

- (i) For post-incident analysis, it is important that the origination and reception of Railway emergency calls by mobiles is confirmed by a message sent to a ground-based central location (and also recorded in the on-train recording device).
- (ii) The confirmation shall be generated automatically without input from the user.
- (iii) The confirmation message shall commence at the end of the call or if the radio moves out of the call area.
- (iv) If the radio loses contact with the network, the mechanism shall commence as soon as possible on regaining communications, for up to a maximum of 5 minutes without achieving contact.
- (v) For Railway emergency calls initiated by a mobile, the automatic confirmation message of the initiating mobile shall contain:
 - the time at call establishment;
 - the time at clear down;
 - the functional number of the call originator;

- the train number and engine number of the call originator, if a train.
- (vi) For Railway emergency calls received by a mobile, the automatic confirmation message of the receiving mobile shall contain:
- the time at which the call was first received;
 - the time at which the call was lost (or terminated);
 - the group identity of the sender;
 - the functional number of the recipient;
 - the train number and engine number of the recipient, if a train.

Station Working Rules (Station Name)

- (i) The Station working rules (SWR) must be read in conjunction with General & subsidiary Rules and Operating Manual. These rules do not in any way supersede any rule in the above books. The language of SWR should be simple, brief and unambiguous applying provision of rules to the specific conditions at the relevant station. These rules must be in simple language intelligible to ordinary DFCCIL staff. However, relevant GR/SR Numbers may be mentioned in the brackets.
- (ii) The SWR must be page numbered with the station name code written on each page and signed by the nominated operating officer and Signal & Telecom Engineer at interlocked stations and at non-interlocked stations by Nominated Operations officer ,Civil Engineering officer. The officers must sign at each page of SWR. Nominated Electrical officer shall also be associated in electrified sections to finalize the Traction Station working rule(TSWR) and Traction Station Working Rule Diagram(TSWRD)..
- (iii) The SWR should be issued afresh after every five years or after issue of **three** amendment slips and reviewed as and when required.
- (iv) Any innovations introduced to facilitate train operation should be incorporated in SWR.

1. Station working rule diagram :

SWR Diagram No.-----based on GM/Sig.DFCCIL and Signal Interlocking Plan No.- - -----should show the complete layout of the yard, Points, Signals, gradients and interlocking arrangements of the station including the non-interlocked sidings, exact and actual holding capacity of all the individual lines in metres, actual inter signal (demarcation point) distances, names of adjacent stations and IBH signals, where provided, on either side of the station with their respective distances from the centre line of the station building to the central line of the adjacent stations and any other information necessary in the day to day operation of trains. The particulars of date upto which it is corrected should also be mentioned. SWR diagram should show actual distances and not the minimum prescribed. The SWR must be signed by the nominated operating and Signal & Telecom Engineer at interlocked stations and at non-interlocked stations by nominated Operations Manager and Civil Engineer. The SWR should be signed at each page. Electrical engineer shall also be associated in electrified sections.

2. Description of station

2.1 General (Location)

----- (Name of the station) is a ----- class station on the ----- (name of the section) double/single line Electrified section of ----- DFCCIL on ----- route. It is situated at KM ----- from ----- (a nominated point on the DFCCIL).

2.2 BLOCK STATIONS, IBH, IBS ON EITHER SIDE AND THEIR DISTANCE AND OUTLYING SIDINGS.

----- Station is situated between ----- (Name of adjacent station on one side) in the ----- (North/South/ East/West) side at a distance of ----- km and ----- (Name of adjacent station on the other side) in the ----- (North/South/ East/West) at a distance of ----- km.

In case of IBS signal being provided in the adjacent section the mention of the same need to be made as follows: The section between ----- (name of the section on which the IBS is provided) has been split into two Block sections by providing Track Circuit/Axle Counters and Intermediate Block Stop Signal at Km. ----- and Km. ----- on Up and Dn lines respectively, which are controlled by Track Circuit/Electronic Axle Counter.

In case the adjacent section is provided with the automatic signals, necessary mention of the same need to be made in the SWR literature.

In case of outlying sidings/DK station taking off from the section its name and Km in Up/Dn direction should be mentioned. Their detailed working instructions should be given in Appendix 'F'.

2.3 BLOCK SECTION LIMITS ON EITHER SIDE OF THE STATION ON DIFFERENT DIRECTIONS

Points up to which block section in rear terminates and the point from which the block section in advance starts should be indicated in tabular format:

Between The point from which the point at which the Stations. The "Block Section" "Block Section" ends commences

2.4 GRADIENTS IF ANY

The gradients in the yard and the adjacent block sections should be mentioned with their locations. Any gradient which are steep enough to warrant special precaution in train operation should be mentioned.

2.5 LAY OUT

Under this head, information pertaining to the number of running lines in the main yard, (namely UP Loop, UP Main, DN Main and Common Loop etc.), Goods sheds/siding, Hot Axle siding, passing sidings, engineering sidings, sidings taking off from the yard with the details whether electrified etc. And how they are isolated from the running lines should be mentioned. The information in relation to provision of the running lines/goods sidings should be given.

2.5.1 RUNNING LINES, DIRECTION OF MOVEMENT & HOLDING CAPACITY IN CSR.

The direction of movements on all the lines and Clear Standing Room of running lines in terms of metres need to be specified.

2.5.2 NON RUNNING LINES AND THEIR CAPACITY IN CSR

2.5.3 ANY SPECIAL FEATURE IN THE LAYOUT.

Any special feature of the yard such as catch siding, slip siding, non-standard turn outs, curves, spring points etc. having bearing on the operation of trains need to be mentioned.

2.6 LEVEL CROSSINGS:

Detailed working of the gate along with the particulars regarding LC gate No., location, class, normal position, whether communication provided or not and whether Train Protection and Warning System (TPWS) provided or not, how the gate is operated etc, need to be mentioned in Appendix 'A'.

3. SYSTEM AND MEANS OF WORKING

System of working in force -Absolute/Automatic by using Double line/Single line Tokenless Block Instruments, whether co-operative or non-co-operative, the staff responsible for their operation and custody of keys should be clearly mentioned. Mention should also be made of the availability of block telephone at the station and Telephone provided at IBS posts to establish contact by the Loco pilot with Station Master in rear, in case of any necessity.

4. SYSTEM OF SIGNALLING AND INTERLOCKING

- 4.1** The Standard of interlocking, type of signalling (MACLS), method of operating the signals/points from VDU, provision of axle counters/ track circuits on running lines, Calling-On Signals/ IBS, special signalling features such as stop boards at terminal stations, emergency cross-overs, permanently locked points, motor operated points, emergency/ crank handle keys and their custody, indications (electric type) of points/ trap points/ signals/ track circuits/ axle counters need to be mentioned. The detailed description of the Video Display Unit for route setting using point/signal/gate control switches, individual operation of points, operations of gates within the station limits, setting of points using the crank handle and the maintenance of proper records of emergency operation counters provided on the panel need to be mentioned here. Procedure for working of stations provided with Train Protection and Warning System need to be mentioned. The procedure for resetting of the system in case of failure of Axle counter on berthing portion as well as IBS section, emergency operation of points, emergency route cancellation, clearing of block etc. also need to be mentioned from operations point of view.

(Details of signalling and interlocking should, however, be given in Appendix 'B' and details of Train Protection and Warning System, if provided, be given in Appendix 'C').

4.2 CUSTODY OF RELAY ROOM KEY AND PROCEDURE FOR ITS HANDING OVER AND TAKING OVER BETWEEN STATION MASTER AND S&T MAINTENANCE STAFF.

4.3 POWER SUPPLY

The sources of Power supply for Signalling such as DN AT/UP AT/ Local supply (State Electricity Board)/Diesel Generator/UPS/Integrated Power Supply etc. Should be mentioned here. It should be clearly mentioned whether the change over from one source of supply to the other shall be automatic or manual in case of failure of normal source of supply. The procedure for manual change over should be described.

5. TELECOMMUNICATION:

The availability of the telecommunication facilities at the station and their operational aspects should be clearly defined:

- i) Section Control/Dy. Control/Traction Power Control Telephone, etc.
- ii) Auto/DOT Telephones,
- iii) Magneto Telephone with the gates,
- iv) IBS Telephone with IBS at Km. -----,
- v) Telephone with Axle Counter reset boxes,
- vi) Telephone for yard communication,
- vii) VHF Sets, and
- viii) Mobile Train Radio Communication (MTRC)

The action to be taken in case of failure of communication given above to be clearly spelt out. (Details of working should be given in appendix 'B')

6. SYSTEM OF TRAIN WORKING:

6.1 DUTIES OF TRAIN WORKING STAFF

The duties of the train working operational staff such as Station Master, Pointsman and Gateman for train operation should be mentioned in detail in Appendix 'D' giving specific references to the G&SR of the DFCR-GR and the Operating Manual.

6.1.1 TRAIN WORKING STAFF IN EACH SHIFT

The availability of above operation staff provided at the Station in each shift with their duties for working of trains should be mentioned in Appendix 'D'.

6.1.2 RESPONSIBILITY FOR ASCERTAINING CLEARANCE OF THE LINES AND ZONES OF RESPONSIBILITY.

Responsibility for ascertaining clearance of lines and zones of responsibility of each of the staff on duty should be clearly mentioned here. Mention should be made that Private Number Book should be under the custody of train passing staff who is authorised to use it.

6.1.3 ASSURANCE OF STAFF IN THE ASSURANCE REGISTER

Every train passing staff posted newly at the station or leave reserve staff at the station or regular staff who has resumed his duties after more than 15 days absence must go through Station Working Rules in force and give assurance in the prescribed Assurance Register.

6.2 CONDITIONS FOR GRANTING LINE CLEAR:

Under this head, principles of the System of Working in force on the stations should be described briefly and clearly as applicable to the station. Specific points on the track upto which the line is required to be kept clear must be indicated. Mention of outlying sidings, if involved, may also be made.

6.2.1 Any Special Conditions To Be Observed While Receiving Or Despatching A Train

- 6.2.1.1 Setting of points against block line.
- 6.2.1.2 Reception of train on blocked line.
- 6.2.1.3 Reception of train on non-signalled line.
- 6.2.1.4 Despatch of train from non-signalled line.
- 6.2.1.5 Despatch of train from line provided with common starter signal.
- 6.2.1.6 Any other special conditions should be mentioned giving reference to the G&SR.

6.3 Conditions for taking 'off' approach signals:

This needs to be mentioned here giving reference to the relevant provisions of the G&SR.

6.3.1 Responsibility of Station Master for restoration of signals to 'on'.

Station Master should ensure that signal is put back to 'ON' after passage of the train as per [5.22 .2\(b\)](#)

6.4 Simultaneous Reception/ Despatch, Crossing And Precedence of trains:

This should mention the specific setting of points and traps for achieving the desired signal overlaps/isolations to Sand Humps/sidings etc. While receiving trains simultaneously, crossing and giving precedence to trains at the station.

6.5 Complete Arrival of Trains

Responsibility for verification of complete arrival of trains before closing the block section should be made clear. In case Block Proving by Axle Counter (BPAC) installed

on the section, the procedure of block working should be mentioned, giving reference to the relevant provisions of G&SR and Operating Manual.

6.6 Despatch of trains:

Particulars regarding starting of trains from running lines, non-signalled lines, issue of caution orders etc should be mentioned giving reference to the provision of G&SR and Operating Manual. In case IBS is provided, the procedure for despatch of trains up to the IBS and thereafter to the next station should be clearly defined.

6.7 Trains running through:

The provisions given in G&SR should be mentioned.

6.8 Working in case of failure:

Working in case of failure of track circuits, points, signals, block instruments, axle counters, Axle Counter Block, procedure for working over damaged points, reception of trains on obstructed lines, non-signalled line including failure to read the occupation of line by trolley or light engine etc. should be mentioned in detail here.

6.9 Provisions for working of trolleys/motortrolleys/ material lorries:

Some of the precautions such as given below should be mentioned:

- (i) The section where axle counters are provided in lieu of track circuits, Trolleys, Motor Trolleys, Lorries etc., which are not insulated, shall not be allowed to run except on line clear.
- (ii) Motor trolleys/ Tower Wagon/ Material Lorries are not likely to actuate the Axle counter correctly. When they are to run over the section split by Axle counters, the whole section to be treated as one and next train to be started after the last train has arrived complete.
- (iii) In all other respects the working of a light Motor trolley shall conform to the rules laid down for ordinary trolleys while running without block protection and to those laid down for motor trolleys while running under block protection or following another light motor trolley or a motor trolley.
- (iv) Any other restriction on movement of trolleys/ motor trolleys/material lorries/tower wagons etc.

7. Blocking of line:

The precautions to be taken by the Station Master, when lines are blocked by stabled vehicles or otherwise for maintenance works, to be detailed here.

8. Shunting:

- 8.1 General precautions
- 8.2 Shunting in the face of approaching train
- 8.3 Prohibition of shunting, special features if any.
- 8.4 Shunting on single line – Within station section Between Last Stop Signal and opposite First Stop Signal. Beyond opposite First Stop Signal During failure of block instrument on single line.

- 8.5 Shunting on double line. Block back Block forward following a train travelling away. Up to IBS, beyond IBS, during failure of block instrument on double line.
- 8.6 Shunting in the siding taking off from station yard/ goods yard.

9. **Abnormal conditions**

(a) **The Rules To Be Observed In The Event Of Abnormal Conditions.**

The procedure to be followed in the event of following abnormal conditions should be specifically mentioned for cases listed below : -

- (i) During partial interruption/ failure of Electrical communication instrument.
- (ii) The authority to proceed in the occupied block section in case of obstruction of line or accident etc.
- (iii) Trains delayed in block section
- (iv) Failure/passing of intermediate block stop signal at 'ON'.
- (v) Failure of Axle Counter Block/ BPAC
- (vi) Failure of MTRC

(b) **Procedure For Emergency Operation Of Points By Crank Handle.**

- (i) The detailed procedure for emergency crank handle operation of motor operated points at different lines at the station from operation point of view should be mentioned here.
- (ii) Procedure for Emergency operation of point with point zone axle counter/track circuit failure and emergency route release, giving reference to ~~GR 3.39 & GR 3.37~~ DFCR-GR-9.01 should be mentioned.

(c) **Certification Of Clearance Of Track Before Calling On Signal Operations Initiated.**

Mention should be made that before taking off Calling-on Signal during failure of track circuit/axle counter, the route and the clearance of the track over which train would pass to be verified by SM/ASM.

(d) **Reporting Failure Of Points, Track Circuit/Axle Counter And Interlocking.**

- i) Mention should be made that whenever there is a failure of points, track circuit/ Axle Counter or any other interlocking gear at the station, the failure should be reported by SM/ASM on duty to the concerned Signalling Maintenance Staff on duty responsible for attending to the failure and only after receipt of the written memo from the Signalling Staff for rectification of the fault, SM/ ASM should restore the normal working..
- (ii) The entries in failure register to be done with message to the Section Controller.

9.1 **TOTAL FAILURE OF COMMUNICATION**

Provision of the rules and instructions laid down in GR & SR relating to the working of trains during total failure of communication at the station should be briefly summed up giving the action to be taken and by whom and what precaution to be taken giving reference to the relevant provisions of the G&SR.

9.2 TEMPORARY SINGLE LINE WORKING ON DOUBLE LINE SECTION

9.3 DESPATCH OF TRAIN UNDER AUTHORITY TO PROCEED WITHOUT LINE CLEAR OR TO ASSIST THE CRIPPLED TRAIN.

10. VISIBILITY TEST OBJECT(V.T.O.)

Position of the Visibility Test Object in each Zone of operation and the officials authorised to check the V.T.O from a nominated place at the station should be mentioned here.

11. ESSENTIAL EQUIPMENTSAT THE STATION

The list of the essential equipment should be given in Appendix-‘E’.

12. FOG SIGNAL MEN NOMINATEDTO BE CALLED IN CASE OF FOG

In Foggy or tempestuous weather or in dust storm when V.T.O. cannot be seen from the SM’s Office, the SM shall send trained men to act as fog signalmen. Instructions regarding their selection from Traffic and Engineering Departments, entry of their names in the Fog Signal Register and taking assurance by the SM to be mentioned clearly.

LIST OF APPENDICES OF SWR

APPENDIX 'A'	WORKING OF LEVEL CROSSING GATES
APPENDIX 'B'	SYSTEM OF SIGNALLING AND INTERLOCKING AND COMMUNICATION ARRANGEMENTS AT THE STATION
APPENDIX 'C'	TRAIN PROTECTION AND WARNING SYSTEM
APPENDIX 'D'	DUTIES OF TRAIN PASSING STAFF AND STAFF IN EACH SHIFT
APPENDIX 'E'	LIST OF ESSENTIAL EQUIPMENTS PROVIDED AT THE STATION
APPENDIX 'F'	RULES FOR WORKING OF DK STATIONS, HALTS, IBH, IBS, AND OUTLYING SIDINGS
APPENDIX 'G'	RULES FOR WORKING OF TRAINS IN ELECTRIFIED SECTIONS

APPENDIX B**Normal period for which Station Operating Registers and Records are required to be preserved:**

Description of the Book/Form	Period of preservation from the date of
Train passing registers/Books/Forms	1 year
Muster Roll	Permanent record
Caution order register and Caution Order books	1 year
Load Stable Register	1 year
Damaged Stock Register/ Sick Wagon Register [Attaching/Detaching]	3 years
Control Order Book/Conference Book	3 years
HQ Leaving Permission Register	1 year
Tools and Plant Register	Permanent Record
Register of Important Circulars	Permanent Record
Station Order Book	Permanent Record
Station Inspection Register	Permanent Record
Bio-data Register Register of Safety (PMS, REF etc.) & Personal Details of staff	Permanent Record
Station Master Diary	1 year
Register showing Analysis of Late starts To Goods Trains at important Stations & Detention to Trains outside signals and at adjacent stations	3 years
Unusual Register, other registers and Records maintained in control offices and at specified stations	Local Orders to be issued by ED
Station Imprest Cash Register	3 years

Note:-

- i) In calculating the one year or the three years period, the year to which the books and documents relate, and the year in which they are to be destroyed should be excluded.
- ii) Record pertaining to Court Cases, departmental enquiries should not be destroyed till three years from the date the case is decided.
- iii) Record pertaining to public claims etc., or those under reference from railways, should not be destroyed without permission from ED concerned.

List of authorities to be used during train working

S.No.	Authority No.	Description
1.	S & T 411	Disconnection/Reconnection Notice.
2.	T 519	Paper Line Clear Ticket
3.	T 525	Shunting Order
4.	T 613	Authority To Proceed during prolonged failure of signals on double line section in Automatic Block System.
5	T 704	Authority to receive a train on an Obstructed Line
6	T 705	Authority to receive a train on a Non-signalled line
7	T 706	Authority to start from a Non-signalled line or a line provided by common departure signal.
8	T 806	Caution Order
9	T 806(6)	Nil-Caution Order
10	T 905(A)	Advance Authority to pass defective approach signals at 'ON' position.
11	T 905	Authority to pass defective approach signals at 'ON' position.
12	T 906(1)	Authority to pass defective departing signals at 'ON' or defective position
13	T 912(2)	Message to be exchanged between Station Mangers for introduction of Temporary Single Line Working on a double line section.
14	T 912(4)	Authority for Temporary Single Line Working on a double line.
15	T912(5)	The Following Train System Authority To Proceed
16	T 912(9)	Authority to receive a train during Temporary Single Line Working on a double line approaching on wrong line.
17	T 912(10)	Message to be exchanged between Station Mangers for restoration of normal working after Temporary Single Line Working.
18	T 921(6)	Authority To Proceed Without Line Clear and Proceed into an occupied block section.
19	T 1025	Motor Trolley Following Permit.
20	T 1027	Working of a Motor Trolly/ Lorry/Rail Dolly on full block.

<p align="center">S & T 411DFC Railway Sr. No.----- S and T Department ACKNOWLEDGEMENT OF DISCONNECTION / RECONNECTION NOTICE</p> <p>No.----- To The SM on duty at ----- Station/cabin. It is proposed to disconnect the following Gears:----- ----- ----- On ---/---/20--- From-----hrs-----mnts to-----hrs-----mnts to attend failure / for maintenance.</p> <p>Expected duration of Disconnection----- ----- JE/SE(Signal) / Technician(Signal) Notice about disconnection received at --- hrs.mnts on ---/---/--- 20---.</p> <p align="right">----- Signature of SM Disconnection allowed/ not allowed on ---/---/20--- at ----- hrs.minutes</p> <p align="right">----- Signature of SM Disconnection will be allowed at --- --- hrs.---mnts on --/---/--- 20--- -----</p> <p align="right">----- Signature of SM Reconnected at -----hrs. on ---/---/---20--- -----</p> <p>JE/SE(Signal) / Technician(Signal) Notice of reconnection received at - ---hrs --- mnts. on ---/--- 20---.</p> <p align="right">----- Signature of SM *Fill in the details of the gear/s to be disconnected.</p>	<p align="center">S & T 411 DFC Railway Sr. No.---- S and T Department RECONNECTION NOTICE</p> <p>No.----- Notice for reconnecting signaling gear</p> <p>To The SM on duty at ----- Station. Please note that the disconnected gear(s) referred to in notice no. ----- ----- has / have been reconnected on ---/---/20---at--- hrs.-- mnts.</p> <p align="right">----- Signature JE/SE(Signal) / Technician(Signal)</p> <p>Date ---/---/20--- Time ---hrs---mnts.</p> <p>----- Notice of reconnection received at ---hrs--- mnts. on ---/--- 20---.</p> <p align="right">----- Signature of SM</p>	<p align="center">S & T 411 DFC Railway Sr. No.----- S and T Department DISCONNECTION NOTICE</p> <p>No.----- Notice to Station Manager for disconnecting signalling gear.</p> <p>To The SM on duty at ----- station.</p> <p align="center">Please note that the following gears will be disconnected *----- ----- ----- on---/---/20--- from --- hrs.---mnts. to --- hrs.---mnts. attend failure/for maintenance. Expected duration of disconnection)-----</p> <p align="right">----- Signature JE/SE(Signal) / Technician(Signal) Date ----- Time ----- *Fill in details of the gears to be disconnected.</p> <p>Notice about disconnection received at --- hrs.mnts. on ---/---/--- 20---.</p> <p align="right">----- Signature of SM Disconnection allowed/**not allowed on ---/---/20--- at ----- hrs.mnts.</p> <p align="right">----- Signature of SM Disconnection will be allowed at --- --- hrs.--- mnts. on ---/---/--- 20-----.</p> <p align="right">----- Signature of SM</p>
---	---	---

DFC RAILWAY

PAPER LINE CLEAR TICKET

(Loco Pilot / Record)

*UP/DN

Name of Station _____ Date ___/___/20___
Time ___ hrs ___ mnts.

Paper Line Clear working between _____ station and _____ station.

Line Clear asked by _____ (Name of SM on duty) from _____ SM on duty at
_____ station for train No. _____ *UP/DN.

Through _____ (Means of communication).

Last train in the block section was _____ *UP/DN, which cleared block section
at _____ station.

Line clear *granted/received under Private Number _____ (in words) _____ (in
figures).

* To

The Loco Pilot of Train No. _____

Line is clear and you are authorised to proceed to _____ (station).

***Authority to pass Signal at 'ON' position**

(For Double Line only when Line clear cannot be obtained on block instrument.)

You are authorised to pass *Starter/*Intermediate Starter/*Advanced Starter at 'ON'.

Signature of SM
Station Stamp

*Signature of Loco Pilot

Date / /20 _____ Time hrs _____ mnts.

*Strike out whichever is not applicable.

DFC RAILWAY

SHUNTING ORDER

(Loco Pilot/ Guard/ Record)

Station _____

Date __/__/20__

Time__ hrs __mnts.

To

The Loco Pilot of Train No. _____ *UP/ DOWN.

Please perform shunting as indicated below as per instructions of Station staff/Guard:

1. _____
2. _____
3. _____
4. _____

*You are authorised to pass _____ signal(s) in the 'ON' position and proceed *up to/beyond ** _____ signal.

***Section between _____ station and _____ station is *blocked back/ blocked forward. For this purpose and *Token/ Tablet/ SH Key has been extracted and kept in *safe personal custody/ block instrument has been turned to 'Train On Line' position and locked.

Signature of SM
Station Stamp

Signature of Loco Pilot _____ Date __/__/20__ Time _____hrs ____mnts.

Signature of Guard _____ Date __/__/20__ Time _____hrs ____mnts.

* Strike out whichever is not applicable

** Enter Km or Signal No.

***Applies when Line is Blocked back/ Blocked forward.

DFC RAILWAY

AUTHORITY TO PROCEED DURING PROLONGED FAILURE OF SIGNALS
ON DOUBLE LINE SECTION IN AUTOMATIC BLOCK SYSTEM

(Loco Pilot/ Record)

Station _____ Date ___/___/20__.
Time ___hrs___mnts.

To

The Loco Pilot Train No. _____ * Up/ Down.

All signals between _____ Station and _____ Station have failed. Line
Clear has been received from _____ Station under his Private No. (In words)
_____ (in figures)_____.

You are, hereby, authorised to proceed cautiously on Up/ Down line at a speed not exceeding 25
KMPH and further 15 kmph during bad weather impairing visibility and while passing over facing
points.

You are also authorised to pass Automatic/Semi-Automatic/Manual Stop/Gate signals in between
station _____ and _____ station at 'ON' on this authority.

You shall stop outside the first Stop Signal at _____ Station and thereafter be
guided by the instructions of the Station Manager of that station.

Signature of SM

Station Stamp

I have understood the contents of this authority.

Signature of Loco Pilot _____ Date _____ Time _____hrs _____minutes

* Strike out whichever is not applicable.

DFC RAILWAY

Form No. T 704
Sr.No. _____

AUTHORITY TO RECEIVE A TRAIN ON AN OBSTRUCTED LINE

(Loco Pilot /Record)

Station _____

Date ___/___/20___ Time ___hrs. ___ mnts.

To

The Loco Pilot of Train No . _____ *Up/Down.

Your train is being received on line No.(in words) _____ (in figures) _____

Which is obstructed.

You are hereby authorised to pass *Up/Down*Outer/ Home/ Routing Signals in 'ON' position cautiously at a speed not exceeding 15 KMPH on being accompanied by the bearer of this Authority. You are required to bring your train to a stand observing hand danger signal being exhibited 25 metres before the obstruction.

Signature of SM

Station Stamp

Signature of Loco Pilot _____ Date _____

*Strike out whichever is not applicable.

DFC RAILWAY

AUTHORITY TO RECEIVE A TRAIN ON A NON SIGNALLED LINE

(Loco Pilot /Record)

Station _____

Date __/__/20____ Time __hrs. __mnts.

To

The Loco Pilot of Train No. _____ *Up/Down.

Your train is being received on non-signalled line No.(in words) _____(in figures)_____.

You are hereby authorised to pass *Up/Down *Outer/ Home/ Routing Signals in 'ON' position cautiously at a speed not exceeding 15 KMPH on being accompanied by the bearer of this Authority. You are required to bring your train to a stand before stop board/ fouling mark of line on which your train is being received.

Signature of SM

Station Stamp

Signature of Loco Pilot _____ Date _____

*Strike out whichever is not applicable.

DFC RAILWAY**AUTHORITY TO START FROM A NON SIGNALLED LINE****OR****A LINE PROVIDED BY COMMON DEPARTURE SIGNAL**

(Loco Pilot /Record)

Station _____ Date ___/___/20__ Time__hrs__mnts.

To

The Loco Pilot of Train No. _____ *Up/Down.

Your train is being started from line No. (in words) _____ (in figure _____)
which is * a non-signalled line/ having a common departure signal.

You are authorised to pass *Starter/ Intermediate Starter/ Advanced Starter bearing No.(s) _____ in the 'ON' position and leave the Yard cautiously at a speed not exceeding 15 KMPH over the points duly accompanied by the competent Railway servant up to last set of points of line No. ____ (in figures) and _____ (in words).

Line clear is obtained on *Block Instrument/ Approved Means of communication from _____ Station.

* Private No. received from station in advance (In words) _____ (In figures)

_____ .

Or

Token or Paper line clear ticket No. _____.

Signature of SM
Station Stamp

Signature of Loco Pilot _____ Date _____

*Strike out whichever is not applicable.

Form No. T 806

Sr. No. _____

DFC RAILWAY
CAUTION ORDER
(Loco Pilot/Guard/Record)

STATION _____

Date _____

To

The Loco Pilot of Train No. and Name _____.

You are hereby instructed to exercise the following speed restrictions:-

Sl. No.	Stations between		Kms. And/or position of Indicators if provided		Speed kmph	Cause / Remarks
	From	To	From	To		
1						
2						
3						
4						
5						

Signature of SM
Station Stamp

Signature of Loco pilot _____ Date _____

Signature of Guard _____ Date _____

Form No. T 806(6)
Sr. No. _____

DFC RAILWAY
CAUTION ORDER
(Loco Pilot/Guard/Record)

Station _____

Date ___/___/20___

To
The Loco Pilot of Train No. _____ .

CAUTION ORDER

N I L

Up to _____ Station (Name of next Noticed Station/ Station)

Signature of SM
Station Stamp

Signature of Loco Pilot _____ Date ___/___/20___

Signature of Guard _____ Date ___/___/20___

DFC RAILWAY

ADVANCE AUTHORITY TO PASS DEFECTIVE APPROACH SIGNALS AT 'ON'
POSITION

AT _____ STATION
(Loco Pilot/ Record)

Station _____ Date _____
To _____

The Loco Pilot of Train No. _____ *Up/Down

As per advice of Station Manager on duty at _____ Station, *Up/Down * Outer/
Home/Routing Home signal(s) bearing No.(s) _____ *is/are out
of order.

You are hereby authorised to pass such signal(s) at 'ON' on being hand signalled at the foot of Home
signal at a speed not exceeding 15 KMPH.

Signature of SM
SM Stamp

Signature of Loco Pilot
Date ___/___/20___

*Strike out whichever is not applicable.

DFC RAILWAY

AUTHORITY TO PASS APPROACH SIGNALS AT 'ON' OR DEFECTIVE POSITION
(Loco Pilot / Record)

Station _____

Date ___/___/20__

Time ___hrs___mnts.

TO

The Loco Pilot of Train No._____ Up/Down

You are hereby authorised to pass the defective * Outer /Home /

Routing Home / signal(s) at 'ON' position at a speed not exceeding 15 KMPH.

The train will be admitted on line No.(in words)_____and (figures) _____.

Signature of SM
SM Stamp

Signature of Loco Pilot
Date ___/___/20__

* Strike out whichever is not applicable.

DFC RAILWAY

AUTHORITY TO PASS DEPARTING SIGNALS AT 'ON' OR IN DEFECTIVE POSITION
(Loco Pilot / Record)

Station _____
_____/_____/20__

Date

Time ___hrs___mnts.

TO

The Loco Pilot of Train No. _____ Up/Down, waiting to depart from line No.-----

(1) You are hereby authorised to pass the *Starter/Intermediate Starter /Advanced Starter signal(s) at 'ON' position.

*(2) Applicable for Double Line only –

(In case of failure of Advanced Starter Signal/Last Stop Signal) - Line clear has been obtained on _____ (means of communication) from _____ station. Private No. received is (in figures) _____ (in words) _____ .

*(3) Applicable for IBS- You are authorised to pass IBS at 'ON' without stopping. Line Clear has been obtained on _____ (means of communication) from _____ (station). Private number received is _____ (in words) _____ (in figures)

Signature of Loco Pilot

Signature of SM

Station Stamp

Date _____

*Strike out whichever is not applicable.

DFC RAILWAY

MESSAGE TO BE EXCHANGED FOR INTRODUCTION OF TEMPORARY SINGLE LINE WORKING ON A DOUBLE LINE SECTION

(A) For station proposing to introduce Temporary Single Line Working.

No. _____ Date ___/___/20___ Time ___ hrs. ___ mnts.

From
Station Manager _____ station

To
Station Manager _____ station

- (1) Temporary Single Line Working is proposed to be introduced on *Up/Down line between _____ and _____ station due to _____.
- * (2) _____ station(s) shall be closed during Temporary Single Line Working.
- (3) Obstruction on * Up/Down exists at _____ Kms.
- (4) Last train No. _____ * Up/Down over the line on which Temporary Single Working is been introduced has arrived at my station at _____ hrs.
Private No. _____ (in words) _____ (in figures).

Signature of SM

(B) For station acknowledging Temporary Single Line Working

From
Station Manager _____ station

To
Station Manager _____ station

Refer your message no. _____. I have understood that Temporary Single Line Working is proposed to be introduced on *Up/Down line between _____ and _____ stations due to _____. Last train No. _____ * Up/Down left my station on the line on which Temporary Single Working is being introduced has arrived complete at your station.

Private No. _____ (in words) _____ (in figures).

Signature of SM

*Strike out whichever is not applicable.

DFC RAILWAY

AUTHORITY FOR TEMPORARY SINGLE LINE WORKING ON DOUBLE LINE

(Loco Pilot/ Guard/ Record)

Station _____

Date ___/___/20___

To: The Loco Pilot of Train No. _____ **UP/ DOWN**

(1) LINE CLEAR TICKET

The line is clear and you are authorised to proceed on Up/ Down Line up to _____ station, Private No. received from station in advance is (in words) _____ (in figures) _____.

(2) AUTHORITY TO PASS SIGNAL(s) IN 'ON' POSITION

You are authorised to pass *Starter/ Intermediate Starter/ Advanced Starter Signal(s) bearing No.(s) _____ at 'ON'.

- * Observe hand signal at the foot of the 1ST starter signal.
- * You are authorised to pass signals of intermediate _____ station(s) at 'ON' which has*/ have* been closed temporarily for single line working.
- * Your train shall start from the line not provided with departing signals. Start on being piloted by the railway servant on duty at station.

(3) CAUTION ORDER

- * (i) Your train is going on **Right line/ Wrong line*. The obstruction exists at kms. _____ on *Up/Down line. Switch On flasher light when proceeding on Wrong line.
- * (ii) You have to inform the Gate men and Trackman enroute regarding Introduction of single line working on *Up line/ Down line.
- * (iii) Your Train is the First Train to work under Temporary Single Line working. Speed of your train shall be restricted to 25 KMPH subject to observance of other speed restriction in force.
- * (iv) Observe "Neutral section" on the line on which your Train is going. (*For electrified section*).
- * (v) *There are no Trap Points on the line in question/ Trap points have been clamped/ cotterbolted/spiked.
- * (v) Following are the caution Orders in force in Block Section-

Sr No	Station between		KILOMETRAGE		Speed KMPH	Cause/ Remarks
	From	To	From	To		
1						
2						

Signature of SM
Station Stamp

I/We have understood the contents of this authority.

Signature of Loco Pilot

Signature of Guard

*Strike out whichever is not applicable.

DFC Railway

Form No. T/912 (5)
S. No. _____

**THE FOLLOWING TRAINS SYSTEM
AUTHORITY TO PROCEED
(Up or Down)**

Train No. _____ Up or Down _____ Date _____
Time _____ Hours _____ Minutes.
From _____ Station, To _____ Station.

To Loco Pilot

(1) You are hereby authorized to proceed with your train from _____ station
to _____ station

*(2) Train No. _____ ahead of your train left this station at _____ hours
_____ Minutes.

*(3) Train No. _____ shall follow your train from this Station at _____ hours
_____ minutes.

*(4) You are required to observe a speed restriction of _____ kilometres /hour.

Signed _____
Station Master at _____
(Station stamp)

Signature of the Loco Pilot at _____ station.

*Strike out whichever is inapplicable.

Form No. T 912(9))

Sr. No. _____

DFC RAILWAY

**AUTHORITY TO RECEIVE A TRAIN DURING TEMPORARY SINGLE LINE WORKING
ON DOUBLE LINE APPROACHING ON WRONG LINE**

(Loco Pilot /Record)

Station _____

Date __/__/20__ Time _____hrs.

To

The Loco Pilot of Train No. _____ *Up/Down.

Your train will be received on line No.(in words) _____(in figures)_____.

You are hereby authorised enter cautiously at a speed not exceeding 15 KMPH on being accompanied by the bearer of this Authority.

Signature of SM

Station Stamp

Signature of Loco Pilot _____ Date _____

DFC RAILWAY

**MESSAGE TO BE EXCHANGED FOR RESTORATION OF NORMAL WORKING AFTER
TEMPORARY SINGLE LINE WORKING**

(A) For station proposing to restoring normal Working.

Date ___/___/20___

No. _____

Time _____ hrs. _____ mnts.

From

Station Manager _____ station

To

Station Manager _____ station

* (1) Normal Working shall be introduced between _____ and _____ station after arrival of train No. _____ at your station.

* (2) Normal Working shall be introduced between _____ and _____ station after train No. _____ arrived at my station at _____ hrs.

(3) The obstruction on *Up/Down line at Km _____ has been removed as per information received from _____ vide No. _____.

Private No. _____ (in words) _____ (in figures).

Signature of SM

(B) For station acknowledging normal working

From

Station Manager _____ station

To

Station Manager _____ station

* (1) Refer your message no. _____. Train No. _____ has arrived complete at my station at _____ hrs. Normal working shall be restored on *Up/Down line between _____ and _____ stations.

* (2) Refer your message no. _____. Train No. _____ which left last has arrived your station complete at _____ hrs. Normal working shall be restored on *Up/Down line between _____ and _____ stations.

Private No. _____ (in words) _____ (in figures).

Signature of SM

*Strike out whichever is not applicable.

*UP/DOWN

Form No.T 921(6)

Sr. No. _____

DFC RAILWAY

AUTHORITY TO PROCEED WITHOUT LINE CLEAR AND PROCEED INTO AN OCCUPIED BLOCK SECTION

(Loco Pilot/ Guard/ Record)

Station _____

Date: ___/___/20__ . Time __ hrs. __ mnts.

To: Loco Pilot of Train No _____

- (1) This order is being given due to Obstruction of UP/DN line between _____ Station and _____ station at KM s. _____.
- (2) You are hereby authorised to proceed cautiously without Line clear. From _____ station up to km _____ on *UP/ DOWN Line with your Train.
- (3) You shall bring your Train to a stop short of km _____ and thereafter be guided by the instructions from the Competent Authority at the site.
- (4) You shall clear the section at station _____

AUTHORITY TO PASS SIGNALS AT 'ON' POSITION

- (1) *You are authorised to pass the Signal(s) No.& description _____, at 'ON' position/ *start from the line not provided with departing signals at a speed not exceeding 15 KMPH observing hand signals at the foot of the first starting signal.

CAUTION ORDER

- (1) You are permitted to work your Train upto km _____ between Station _____ and _____ station s with the speed of 25 kmph when view ahead is clear and 15 kmph at night or when view ahead is not clear or when brake-van is leading.
- (2) Caution Orders in force in the Block Section are as under:-

Sl. No.	Station between		Kilometrage		Speed kmph	Cause/ Remarks
	From	To	From	To		
1						
2						

Signature of SM

SM Stamp

I have understood the contents of this authority.

Signature of Loco Pilot _____

Signature of Guard _____

*Strike out whichever is not applicable.

DFC RAILWAY

MOTOR TROLLEY FOLLOWING PERMIT
(Original/Duplicate)

Station _____

Date ___/___/20__.

From Station Manager _____

To _____ (Officer-in-charge) Motor Trolley No. _____.

You are hereby being permitted to follow *Train No. _____/Motor Trolley No. _____ in the blocksection upto _____ Station.

The Train No. _____/Motor Trolley No. _____ left this station at ___ hrs. ___ mnts.

You are also authorized to pass *Up/Down _____ signals at 'ON' position.

On arrival at _____ Station you are required to hand over this permit to Station Manager on duty.

Private No. received (in words) _____ (in figures) _____.

Signature of SM
Station Stamp

Received _____

Signature of *{Official Incharge & Designation} _____.
{Motor Trolley Driver}

*Strike out whichever is not applicable.

DFC Railway Sl. No. _____

WORKING OF A * MOTOR TROLLY/ LORRY/RAIL DOLLY ETC. ON FULL BLOCK.

RECORD

Date ___/___/20___ Time ___hrs___mnts.

No. _____

To _____

The SM _____

** _____ No. _____ is required to work between _____ station and _____ station on Up/Down line from _____ hrs. ___mnts. to _____ hrs. ___ mnts. on full block. The Section will be cleared at _____ station at _____ hrs. ___mnts

Signature of Official In Charge

*The block cannot be permitted/will be granted after passage of Train No. _____ * UP/DOWN.

*The UP/DOWN Line has been blocked for your ** _____ and block will be removed only on receipt of the removal report of ** _____ No. Token/Tablet/PLCT No. _____ issued to you.

Private Number _____ (in words) _____ (in figures).

You are advised to ensure clearance of Block Section within Block permitted.

Signature of SM

Station Stamp

Date ___/___/20___ Time ___hrs. ___ mnts.

Reference: No. _____

** _____ No. _____ has arrived at _____ station at _____ hrs. ___ mnts. / has been removed from the track at km _____. **Block section is clearand free from obstruction.** Token/tablet/PLCTNo. is being surrendered to resume normal Train Working.

Signature of official-in-charge

Removal report received at _____ hrs. ___ mnts. on date ___/___/20___.

Signature of SM

Station Stamp

*Strike out whichever is not applicable.

**Push/Cycle/Moped/Motor Trolley/ Rail Dolly/ Ladder Trolley etc. whichever is applicable to be filled.

DFC RailwaySl.No. ___

WORKING OF A * MOTOR TROLLY/ LORRY/RAIL DOLLY ETC. ON FULL BLOCK

REMOVALREPORT

No. _____

To _____

The SM _____

** _____ No.

_____ has arrived at _____ station at _____ hrs. ___mnts./ has been removed from the track at km _____. **Block section is clearand free from obstruction.**

Token/tablet/PLCT No. is being surrendered to resume normal Train Working..

Signature of official-in-charge

Removal report received at _____ hrs. ___mnts on date ___/___/20___.

Signature of SM

Station Stamp

*Strike out whichever is not applicable.

**Push/Cycle/Moped/Motor Trolley/ Rail Dolly/ Ladder Trolley etc. whichever is applicable to be filled.

DFC RailwaySl. No. _____

WORKING OF A * MOTOR TROLLY/ LORRY/RAIL DOLLY ETC. ON FULL BLOCK

NOTICE FOR WORKING

To _____

The SM _____

** _____ No. _____ is required to work between _____ station and _____ station on *Up/Down / _____ line from _____ hrs. ___mnts. to _____ hrs. ___ mnts. on full block.

The Section will be cleared at _____ station at _____ hrs. ___mnts.

Signature of official-in-charge

Date ___/___/20___ Time ___hrs. ___ mnts.

*The block cannot be permitted/ will be granted after passage of Train No. _____ * UP/DOWN.

*The UP/DOWN Line has been blocked for your **No. _____ and block will be removed only on receipt of the removal report of ** _____ No. _____ Token/Tablet/PLCT No. _____ issued to you.

Private Number _____ (in words) _____ (in figures).

You are advised to ensure clearance of block section within block permitted.

Signature of SM

Station Stamp

Date ___/___/20___
Time ___hrs. ___mnts.

Signature of official-in-charge

Date ___/___/20___ Time ___hrs. ___ mnts.

*Strike out whichever is not applicable.

**Push/Cycle/Moped/Motor Trolley/ Rail Dolly/ Ladder Trolley etc. whichever is applicable to be filled.