



**Tender No. CPM/UMB/UTILITY- SHIFTING/HR-02**

**For**

**CONSTRUCTION OF SERVICE AND RESIDENTIAL BUILDINGS FOR SHIFTING OF UTILITIES IN CONNECTION WITH PROVIDING ENCUMBRANCE-FREE LAND BETWEEN KALANAUR TO AMBALA CITY IN THE JURISDICTION OF CPM/AMBALA.**

## **TECHNICAL BID**

**Employer:**

**DEDICATED FREIGHT CORRIDOR CORPORATION OF INDIA LIMITED  
(A GOVERNMENT OF INDIA ENTERPRISE  
Under  
MINISTRY OF RAILWAYS)**

DFCC /UMB

UTILITY SHIFTING-HR

---

**Dedicated Freight Corridor Corporation of India Ltd**

**Tender Notice No.CPM/UMB/UTILITY- SHIFTING/HR-02      Dated 04.06.2014**

Name of work : Construction of Service and residential buildings for Shifting of Utilities in connection with providing encumbrance-free land between Kalanaur to Ambala City in the jurisdiction of CPM/ Ambala

Approx. Cost : Rs.1785.00Lac

Completion Period : 14 (Fourteen) months

Earnest Money : Rs.30,00,000/-

Last Date/Time of receipt of Tenders : Upto1500hrs. on 18.07.2014

Date of Opening of Tender : 18.07.2014 at 1530hrs.

**For and on behalf of**  
**DFCCIL,Ambala**

---

Bidders Signature

Page 2  
For DFCCIL

**INDEX**

	<b>Notice inviting Tender</b>	<b>Page No. 04</b>
<b>Part I</b>		
Chapter- 1	Preamble and General Instructions to Tenderers	Page No. 05-25
Chapter II	Conditions of Contract	
	A. General Conditions of the Contract	Page No.26-72
	B. Special Conditions of the Contract	Page No. 73-83
Chapter III	Price & Payments	Page No.84-91
Chapter IV	Technical Specifications	
	A. Civil Works	Page No.92-95
	B. Electric Works	Page No. 96-104
Chapter V	Drawings	Page No. 105-109
<b>Part II</b>	Tender Forms	Page No.110-136

## Notice Inviting Tender

**Tender No. CPM/UMB/UTILITY- SHIFTING/HR-02**

**Dated 04.06.2014**

The Chief Project Manager DFCCIL Ambala for and on behalf of DFCCIL invites sealed opened tender on the prescribed forms for the under noted work:

SN	Name of work	Appx cost/ Earnest money in Rs.	Period of Completion	Availability of documents/ Cost of tender document	Submission of tender document and opening	Validity of Bid
1	<b>Construction of Service and residential buildings for Shifting of Utilities in connection with providing encumbrance-free land between Kalanaur to Ambala City in the jurisdiction of CPM/ Ambala</b>	Rs.1785.0 0 Lac  Earnest Money Rs.30,0 0,000/	14 (Fourteen ) months	On any working day from 1030 hrs to 1500 hrs from 04.06.2014 to 17.07.2014  Rs.11250.0 0 per set	Up to 1500 Hrs on 18.07.2014 and will be opened soon thereafter in the office of <b>Chief Project Manager</b> DFCCIL Old Railway Colony Near Anand Market Ambala Cantt	120 days from the date of opening

Tender Notice & Tender document will be available on [www.dfccil.org](http://www.dfccil.org) & **Central Procurement Portal (eprocure.gov.in)** from the date of availability of tender papers. Tender documents also available in CPM, DFCCIL, Old Railway Colony, Near Anand Market, Ambala Cantt office On any working day from 1030hrs to 1500hrs from 04.06.2014 to 17.07.2014 on payment of Rs.11250/- through pay order, banker's cheque and demand drafts in f/o Dedicated Freight Corridor Corporation India Limited, payable at Ambala. Submission of tender documents may be done Up to 1500 Hrs on 18.07.2014 and will be opened at 1530 Hrs thereafter in the office of **Chief Project Manager** DFCCIL Old Railway Colony, Near Anand Market Ambala Cantt.

**Chief Project Manager  
DFCCIL, Ambala Cant**

**PART-I**

**Chapter – I**

**PREAMBLE & GENERAL INSTRUCTIONS TO TENDERERS**

**1.1.1 Introduction**

**(i) General**

Dedicated Freight corridor Corporation of India Ltd. (DFCCIL), a public sector undertaking has been set up under the Indian Companies Act 1956 for implementation of Dedicated Freight Corridor Project. Government of India is the sole shareholder of the DFCC.

Ministry of Railways (MOR), Government of India has planned to construct Dedicated Freight Corridor (DFC) covering about 3338 route kilometers on Eastern and Western Corridors. The coverage of Eastern Corridor is from Ludhiana to Dankuni and Western Corridor is planned from Jawaharlal Nehru Port, Mumbai to Rewari / Tughlakabad / Dadri near Delhi. There will be a linkage between two corridors at Dadri.

**(ii) Eastern Dedicated Freight Corridor**

Eastern DFC Route will be approximately 1839 Km long from Dankuni to Ludhiana via Dankuni – Asansole – Dhanbad – Gaya – Sonnagar - Mughalsarai-Allahabad-Kanpur-Tundla-Aligarh-Khurja - Bulandshahr – Meerut – Saharanpur – Ambala - Ludhiana. Proposed alignment of DFC has been generally kept parallel to existing Indian Railway line except provision of detours at some stations where the existing yards /cities are congested .

**(iii) Scope of Work**

On behalf of DFCCIL, CPM /Ambala/ Dedicated Freight Corridor Corporation of India Limited, Old railway Colony, Near Anand Market, Ambala Cantt. Here in after referred to as 'DFCCIL' is inviting sealed tenders from established, and experienced Contractors for execution of the following work:

**“Construction of Service and residential buildings for shifting of Utilities in connection with providing encumbrance-free land between Kalanaur to Ambala City in the jurisdiction of CPM/ Ambala”**

- (iv) Scope of work is as per the requirements given in the bid document but not limited to:
- (a) Setting out of works as per drawings
  - (b) Supply and stacking of materials.
  - (c) Testing of Raw materials
  - (d) Execution of works as per standard drawings
  - (e) Testing of work during execution
  - (f) And handing over the work to Railways.
  - (g) Other miscellaneous works.
- (v) Cost of the work: The estimated cost of the tendered work is approximately Rs 1785.000 lacs.
- (vi) The tenderer shall be governed by General Conditions of Contract (GCC), preamble and general instructions to tenderers and special conditions of contract (SCC). Wherever there is conflict in any condition between GCC and, Special condition of contract mentioned in tender documents, the condition mentioned in special conditions will prevail. However Engineer's decision in this connection shall be final and binding.  
Part 1, Chapter-II contains (A) General conditions of contract and (B) Special conditions of contract specific to this work and shall be applicable in the contract.

**(vii) Location**

Work is to be executed in the jurisdiction of Chief Project Manager, DFCCIL, Ambala. However, DFCCIL reserves right to change the site of work anywhere in adjacent / adjoining area of the work defined in Para 1.1.1 (iii) above in the jurisdiction and the contractor shall be bound to execute the work without any extra cost.

**1.1.1(a) DELETED**

**1.1.1(b) TENDER BID**

The Tender Bid shall be submitted **in one sealed cover with two separate sealed Packets** as under:-

**Packet -A**

Eligibility/Qualifying element of the Tender Bid, here in after called **“TECHNICAL BID”**

### **Packet –B**

Price elements of the Tender Bid herein after called “**Financial- Bid**”.

The details to be included in Technical Bid (Packet A) And Financial- Bid (Packet-B) are as per 1.1.1(c) below:

The **Technical- Bid (Packet-A)** shall be opened on the date of tender opening. The detailed scrutiny of Technical Bid shall be carried out. The “**Financial- Bid (Packet-B)**” shall be opened only of those tenderers who qualify in Technical Bid. The **Financial- Bid** of un-qualified tenderers shall be returned without opening the **Packet B**. The detailed procedure for tender opening and processing is given in Para 1.1.3.10.

#### **1.1.1 (c) FORM OF TENDER**

The Tender documents shall be in two **separate sealed packets** viz:-

**Packet -A** containing Technical bid and **Packet –B** containing Financial bid. Detailed credentials as per the requirement of eligibility criteria and all tender papers except Schedule of Prices are to be submitted in “Technical- Bid” i.e. **Packet-A**.

Schedule of Prices with percentage above/below/at par duly filled in are to be submitted in “Financial –Bid” i.e. **Packet-B**.

Completed tender documents in two packets viz. Packet-A and Packet-B shall be sealed separately in envelopes super scribing as **Packet-A (Technical Bid)** and **Packet- B (Financial Bid)** along with the name of the work. These two sealed Envelopes and the envelop superscribed “**Earnest Money for the work**” containing the Earnest money and cost of Tender document in case of **downloaded tenders** in the form as prescribed in the tender documents shall further be sealed in a larger envelope superscribing the name of the work as stated above **along with date and time of opening of tenders. Any tender received later than the time and date of opening of tenders shall be rejected and returned to the tenderer/s unopened.**

Any tender document received without Earnest money/ Cost of tender document (if applicable) in prescribed form shall be summarily rejected.

**Tenders not submitted in the proper Forms are liable to be rejected.**

**(a) Documents to be enclosed with each copy of TECHNICAL BID (Packet A) :-**

SN	Description	Documents
(1)	Offer letter complete	Form-1
(2)	Tenderer's credentials in accordance with para 1.1.12	Form- 2A, 2B, & 2 C
(3)	Earnest money in accordance with Para 1.1.7 and cost of tender document in case of downloaded tenders in accordance with Para 1.1.3.3 (In separate cover)	
(4)	Written confirmation authorizing the signatory of the Tender to commit the Tenderer in accordance with para 1.1.4	
(5)	The Tender document shall be duly signed in Ink by the Tenderer, on each and every page as a token of his having studied the Tender document.	

**(b) Documents to be enclosed with the FINANCIAL BID (Packet B)**

SN	Description	Documents
(1)	Offer letter complete with summary of prices as per Financial Bid	Form -4 , Schedule A, B, C & D (Form 5)

**Checklist for Documents to be submitted:**

Sl. No.	Documents to be Attached	Tick appropriate option
1.	Earnest Money Deposit of requisite amount in the prescribed form.	Yes/No
2.	Tender document cost of requisite amount in the prescribed form, in the case of Tender Document downloaded from web site.	Yes/No
3.	The Covering Letter/Form of bid Form-1	Yes/No
4.	(i) Details of completed works in last 3 years and current financial year in the form prescribed Form-2A	Yes/No
	(ii) The relevant documents and certificates from the client.	Yes/No



5.	Power of Attorney of the person signing the tender documents, in original, if specific to this work or photocopy of the General Power of Attorney of the Company in favour of the person signing the tender, duly attested by Notary Public.	Yes/No
6.	Complete Technical Bid including corrigendum duly stamped and signed by the Tenderer on each page.(Technical Bid, Packet-A)	Yes/No
7.	Financial Bid with rates duly filled in, stamped and signed on each page by the Tenderer.(Financial Bid, Packet-B)	Yes/No
8.	Annual turnover of the company/firm for the last three financial years and current financial year with supporting documents and/or Form-16 A issued by Income Tax Dept.	Yes/No
9.	Certified Copy of Sales Tax/Works Contact Tax Registration Certificate	Yes/No
10.	Certified Copy of Registration of Company, Partnership deed /Memorandum and Articles of Association of the firm.	Yes/No
11.	Constitution of the firm in the form prescribed Form-2C	Yes/No
12.	Any other document required as per provisions of tender document	Yes/No

### 1.1.2 Tender Document

This tender document consists of following parts:

#### Packet A (Technical Bid)

#### Notice inviting Tender

#### Part I

Chapter- 1	Preamble and General Instructions to Tenderers
Chapter II	Conditions of Contract
	A. General Conditions of the Contract
	B. Special Conditions of the Contract
Chapter III	Price & Payments
Chapter IV	Technical Specifications

	A. Civil Works
	B. Electrical Works
Chapter V	Drawings
<b>Part II</b>	Tender Forms

## **Packet B (Financial Bid)**

### **Envelope containing EMD and cost of tender Document (if applicable)**

#### **1.1.3 Sale and Submission of Tender Document**

1.1.3.1 Tender document can be purchased from the office of the CPM /AMBALA/ Dedicated Freight Corridor Corporation of India Limited, Old railway Colony, Near Anand Market, Ambala Cantt. on any working day on payment of Rs. 11250/-through pay order, Banker's cheque and demand drafts payable at Ambala in favor of "**Dedicated Freight Corridor Corporation of India Limited, payable at Ambala**". The cost of the tender form is not refundable and also not transferable.

#### **1.1.3.2 Clause applicable for tender documents downloaded from Internet**

Tenderer/s are free to download tender documents at their own risk and cost, for the purpose of perusal as well as for using the same as tender document for submitting their offer. Master copy of the tender document will be available in the office of CPM/Ambala/ Dedicated Freight Corridor Corporation of India Limited, Old railway Colony, Near Anand Market, Ambala Cantt. After award of the work, an agreement will be drawn up. The agreement shall be prepared based on the master copy available in the office of CPM /AMBALA/ Dedicated Freight Corridor Corporation of India Limited, Old railway Colony, Near Anand Market, Ambala Cantt. and not based on the tender documents submitted by the Tenderer. In case of any discrepancy between the tender documents downloaded from the internet and the master copy, later shall prevail and will be binding on the Tenderers. No claim on this account will be entertained.

#### **1.1.3.3 Cost of Tender documents downloaded from internet**

Tender documents are available on Dedicated Freight Corridor Corporation of India Limited website i.e. [www.dfccil.org](http://www.dfccil.org) and the same can be downloaded and used as

tender documents for submitting the offer. The cost of the tender document as indicated above in para 1.1.3.1 above will have to be deposited by the Tenderer in the form of Pay order, Banker's cheque and Demand drafts in favour of '**Dedicated Freight Corridor Corporation of India Limited, payable at Ambala**' along with the Tender document. This should be paid separately and not included in the Earnest money. **In case, tender is not accompanied with the cost of the tender document as detailed above, tender will be summarily rejected.**

1.1.3.4 Complete tender documents must be submitted duly completed in all respects in the tender box in the office of the **CPM /Ambala/ Dedicated Freight Corridor Corporation of India Limited, Old railway Colony, Near Anand Market, Ambala Cantt.** upto **15.00** Hrs on **18.07.2014**. The "**Packet-A ( TECHNICAL BID)**" along with packet containing earnest money/ cost of tender document (if applicable) will be opened at 15.30 Hrs on the same day and read out in the presence of such tenderer(s) as is/are present. Tenders, which are received after the time and date prescribed for submission of tenders shall not be considered. In case the intended date for opening of tenders is declared a holiday, the tenders will be opened on the next working day at the same time. The detailed scrutiny of Technical bid shall be carried out. The detail procedure of tender opening will be as per 1.1.3.10.

1.1.3.5 Tenders sealed and superscribed as aforesaid can also be sent by Registered post addressed to the CPM /Ambala/ Dedicated Freight Corridor Corporation of India Limited, Old railway Colony, Near Anand Market, Ambala Cantt. -133001, India. but a tender which is received after the time and date specified in Para above shall not be considered. Tender delivered or sent otherwise will be at the risk of the tenderers.

1.1.3.6 The rate/s should be quoted in ink in figures as well as in words. If there is variation between rates quoted in figures and in words, the rate quoted in 'words' shall be taken as correct. If more than one or improper rates are tendered for the same item, the tender is liable to be rejected.

1.1.3.7 Each page of the tender papers is to be signed by the tenderers or such person/s on his/their behalf that is/are legally authorized to sign for him/them.

1.1.3.8 **Care in Submission of Tenders** – Before submitting a tender, the tenderer will be deemed to have satisfied himself by actual inspection of the site and locality of the works, that all conditions liable to be encountered during the execution of the works are taken into account and that the quoted rates by tenderer in tender forms are adequate and all inclusive in item of Taxes, Duties & Levies etc. in terms of General/Special Conditions of Contract for the completion of works to the entire satisfaction of the Employer .

1.1.3.9Tenders containing erasures and/or alteration of the tender documents are liable to be rejected. Any correction made by Tenderer(s) in his/their entries must be attested by him/them.

**1.1.3.9.1 Pre-bid conference:** There will be pre-bid conference at 1530 hours on **24.06.2014** in the office of CPM /Ambala/ Dedicated Freight Corridor Corporation of India Limited, Old railway Colony, Near Anand Market, Ambala Cantt. -133001, India. Bidders should give their queries in writing upto 3 days prior to pre-Bid Conference. All interested Bidders may attend the Pre-Bid Conference. DFCCIL's response to queries as well as addenda to bidding document will be posted on the DFCCIL's website. Non-attendance at the pre-Bid conference will not be a cause for disqualification of the Bidder.

All communication between the Employer and the tenderer shall be in writing. For the purposes of seeking clarification, the Employer's address is:

**“Chief Project Manager**

**Dedicated Freight Corridor Corporation of India Limited**

**Old railway colony, Near Anand Market,**

**Ambala Cantt - 133001, INDIA**

**Telephone: +91 – 171 – 2612412, Facsimile number: +91-171-2612412**

**Electronic mail address: [surendersingh@dfcc.co.in](mailto:surendersingh@dfcc.co.in) “**

#### **1.1.3.10 OPENING OF TENDER**

- (a) Tender will be opened at 1530 hrs. on **18.07.2014**, in the office of CPM /Ambala/ Dedicated Freight Corridor Corporation of India Limited, Old railway Colony, Near Anand Market, Ambala Cantt.-133001, in the presence of the tenderers or their representatives as may be present at the prescribed date and time.
- (b) At the time and date prescribed in tender document, the outer sealed cover shall be opened. Thereafter the packet of '**Technical bid (Packet-A)**' only of all the tenderers shall be opened and the contents thereof i.e. qualification details shall be read out. **Financial Bid (Packet-B)** shall be kept in safe custody in sealed conditions.
- (c) After the opening of "Technical bid" (Packet-A) of all the tenderers, these bids shall be scrutinized and analyzed. If found necessary by the Employer, the tenderers shall be asked to furnish clarifications and the Employer may also hold discussions with the tenderer(s) after giving due notice. The names of the tenderers whose bid are considered complete and they meet eligibility criteria shall be short listed.
- (d) The **Financial Bid (Packet –B)** shall be opened on a subsequent date and time duly notified well in advance. The Financial bid shall be opened of only those tenderers who are short listed after scrutiny of their Technical bid. The Financial bid of the tenderers who do not qualify during scrutiny of Technical bid shall not be opened and these shall be returned by the Employer. The time of opening,

date and venue shall be advised to qualified tenderers well in advance to enable them to depute their representative. The earnest money of non-qualifying tenderers will be returned back within a reasonable period of finalization of tender.

#### **1.1.4 Constitution of the Firm:**

**1.1.4.1**The tenderer shall clearly specify whether the tender is submitted as a Sole proprietor or on behalf of a Partnership Firm/JV. If the tender is submitted on behalf of a Partnership Firm he should submit the certified copy of partnership deed along with the tender and authorization to sign the tender document on behalf of partnership firm. If these documents are not enclosed along with tender documents, the tender will be treated as having been submitted by individual signing tender documents. The DFCCIL will not be bound by any power of attorney granted by the tenderer/s or by changes in the composition of the firm made subsequent to the execution of the contract. The DFCCIL may, however, recognize such power of attorney and changes after obtaining proper legal advice.

**1.1.4.2**The tenderer whether Sole proprietor or a Partnership firm or a JV, if they want to act through an authorized representative or individual partner(s) should submit along with the tender, a power of attorney duly stamped and authenticated by a Notary Public or by Magistrate in favor of the specific person whether he/they be partner(s) of the firm or any other person specifically authorizing him/them to submit the tender, sign the agreement, receive payments, witness measurements, sign measurement books, compromise, settle, relinquish any claim(s) preferred by the firm and sign "No Claim Certificate" and refer all or any disputes to arbitration. For JV provisions given in clause 65 of GCC shall be applicable.

#### **1.1.4.3 Partnership Firm-**

##### **Guidelines for submitting tenders by Partnership Firms and their Eligibility Criteria**

1. The Partnership Firms participating in the tender should be legally valid under the provisions of Indian Partnership Act.
2. Partnership Firms are eligible to quote tenders of any value.
3. The Partnership firm should have been in existence or should have been formed prior to submission of tender. Partnership firm should have either been registered with the competent registrar or the partnership deed should have been notarized prior to date of tender opening, as per Indian Partnership Act.
4. Separate identity/name should be given to the Partnership firm. The partnership firm should have PAN/TAN number in its own name and

PAN/TAN number in the name of the any of the constituent partners shall not be considered. The valid constituents of the firm shall be called partners.

5. Once the tender has been submitted, the constitution of firm shall not be allowed to be modified/alterd/terminated during the validity of the tender as well as the currency of the contract except when modification becomes inevitable due to succession laws etc, in which case prior permission should be taken from DFCCIL and in any case the minimum eligibility criteria should not get vitiated. The reconstitution of firm in such cases should be followed by a notary certified Supplementary Deed. The approval for change of constitution of the firm, in any case, shall be at the sole discretion of DFCCIL and the tenderer shall have no claims what so ever. Any change in the constitution of Partnership Firm after opening of tender shall be with the consent of all partners and with the signatures of all partners as that in the Partnership deed. Failure to observe this requirement shall render the offer invalid and full EMD shall be forfeited. If any partner/s withdraws from the firm after opening of the tender and before the award of the tender, the offer shall be rejected. If any new partner joins the firm after opening of tender but prior to award of contract, his/her credentials shall not qualify for consideration towards eligibility criteria either individually or in proportion to this share in the previous firm. In case the tenderer fails to inform DFCCIL beforehand about any such changes/modification in the constitution which is inevitable due to succession laws etc. and the contract is awarded to such firm, then it will be considered a breach of contract conditions, liable for determination of contract under Clause 62 of General Condition of Contract.
6. A partner of the firm shall not be permitted to participate either in his individual capacity or as a partner of any other firm in the same tender.
7. The tender form shall be purchased and submitted only in the name of Partnership firm and not in the name of any constituent partner. The EMD shall be submitted only in the name of partnership firm. The EMD submitted in the name of any individual partner or in the name of authorized partner(s) shall not be considered.
8. One or more of the partners of the firm or any other person(s) shall be designated as the authorized person(s) on behalf of the firm, who will be authorized by all the partners to act on behalf of the firm through a "Power of Attorney", specifically authorizing him/them to submit & sign the tender, sign the agreement, receive payment, witness measurements, sign measurement books, make correspondences, compromise, settle, relinquish any claim(s) preferred by the firm, sign "No Claim Certificate", refer all or any dispute to arbitration and to take similar such action in respect of the said

tender/contract. Such "Power of Attorney" should be notarized/ registered and submitted along with tender.

9. A notary certified copy of registered or notarized Partnership deed shall be submitted along with the tender.
10. On award of the contract to the Partnership firm, a single performance guarantee shall be submitted by the firm as per tender conditions. All the guarantees like Performance guarantee, guarantee for Mobilization advance shall be submitted only in the name of the partnership firm and no splitting of guarantees among the partners shall be acceptable.
11. On issue of LOA, contract agreement with Partnership firm shall be executed in the name of the firm only and not in the name of any individual partner.
12. In case, the contract is awarded to a Partnership firm, the following undertakings shall be furnished by all the partners through a notarized affidavit, before signing of contract agreement:-
  - a) Joint and several liabilities – The partners of the firm to which the contract is awarded, shall be jointly and severally liable to the DFCCIL for execution of the contract in accordance with general and special conditions of the contract. The partners shall also be liable jointly and severally for the loss, damages caused to the DFCCIL/Railway during the course of execution of the contract or due to non-execution of the contract or part thereof.
  - b) Duration of the Partnership deed and Partnership firm agreement – The Partnership deed/Partnership firm agreement shall normally not be modified, altered, terminated during the currency of contract and the maintenance period after the work is completed as contemplated in the conditions of the contract. Any change carried out by partners in the constitution of the firm without permission of DFCCIL, shall constitute a breach of contract liable for determination of contract under clause 62 of General Conditions of Contract.
  - c) Governing Laws – The partnership firm agreement shall in all respect be governed by and interpreted in accordance with the Indian laws.
  - d) No partner of the firm shall have the right to assign or transfer the interest right or liability in the contract without the written consent of the other partners and that of the DFCCIL in respect of the tender/contract.
13. The tenderer shall clearly specify that the tender is submitted on behalf of a Partnership concern. The following documents shall be submitted by the Partnership firm, with the tender-

- a) A copy of registered/notarized partnership deed duly authenticated by notary.
- b) Power of Attorney duly stamped and authenticated by a Notary Public or by a Magistrate from all partners of the firm in favour of one or more of the partner(s) or any other person(s) as detailed in para (8) above.
- c) An undertaking by all the partners of the Partnership firm shall be given that they have not been black listed or debarred by Railways or any other Ministry/Department of the Govt of India/any State Govt from participation in tenders/contract on the date of opening of bids either in their individual capacity or in any firm in which they were/are partners. Concealment/wrong information in regard to above shall make the contract liable for determination under clause 62 of General Conditions of Contract and action will be taken as per clause 16(4)(d) of General Conditions of contract.

14. **Evaluation of eligibility of a partnership firm.**

Technical and financial eligibility of the firm shall be adjudged based on satisfactory fulfillment of the following conditions:

i) **Technical eligibility criteria –**

The tenderer should satisfy either of the following criteria:-

- a) The partnership firm shall satisfy the full requirement of technical eligibility criteria (defined in “Column 1 of para 1.1.12(i) (A) of Preamble and General Instructions to Tenderers”) in its own name and style;

**OR**

- b) In case the partnership firm does not fulfill the technical eligibility criteria in its own name and style, but one of its partners has executed a work in the past either as a sole proprietor of a firm or as a partner in a different partnership firm, then such partner of the firm shall satisfy the technical eligibility criteria (defined in “Column 1 of para 1.1.12(i) (A) of Preamble and General Instructions to Tenderers” ) on the basis of his/her proportionate share in that proprietorship/ partnership firm reduced further by his/her percentage share in the tendering firm.

ii) **Financial eligibility criteria–**

The tenderer shall satisfy either of the following criteria:-



- a) The Partnership firm shall satisfy the full requirements of the financial eligibility criteria (as defined in “Column 1 of para 1.1.12(i) (B) of Preamble and General Instructions to Tenderers”) in its own name and style.

**OR**

- b) In case the partnership firm does not fulfill the financial eligibility criteria in its own name and style, but one or more of its partners have executed a work/contract in the past either as sole proprietor or as partner in different firms, then the arithmetic sum of the contractual payments received by all the partners of the tendering firm, derived on the basis of their respective proportionate share in the such firms reduced further by their respective percentage share in the tendering firm, shall satisfy the full requirements of the financial eligibility criteria (as defined in “para 1.1.12(i) (B) of Preamble and General Instructions to Tenderers”).

**Example on Evaluation of Technical & Financial Eligibility of Partnership Firm**

A tendering partnership firm “ABCD” has four constituent partners namely “A”, “B”, “C” & “D” with their respective shares as 40%, 30%, 20% & 10% , but this firm has not executed any work in its own name and style. However, the constituent partners have executed the work in earlier partnership firm(s) or as sole proprietor as under:-

- (i) Partnership firm “ABZ” having three partners namely “A”, “B” & “Z” with respective shares of 10%, 20% & 70%, has executed a work of value Rs.10.00 crores earlier.
- (ii) Partnership firm “CYX” having three partners namely “C”, “Y” & “X” with respective shares of 50%, 30%, & 20%, has executed a work of value Rs.5.00 crores earlier.
- (iii) Sole proprietorship firm “P” having “D” as sole proprietor has executed a work of value Rs.2.0 Crores earlier. The evaluation of technical and financial eligibility of tendering firm “ABCD” shall be done by taking proportionate share of credentials of partners A, B, C and D derived from their earlier partnership firms to be reduced further by their percentage share in the tendering firm as calculated in table below :-

1	2		3		4		5	
Partners	Credentials of "A" & "B" derived from firm "ABZ" which has executed work of Rs.10.0 cr.		Credentials of "C" derived from firm "CYX" firm which has executed work of Rs.5.0 cr.		Credentials of "D" derived from Proprietorship firm "P" which has executed work of Rs.2.0 cr.		Contribution of "A", "B", "C" & "D" to credentials of tendering firm "ABCD"	
	% share in firm "ABZ"	Proportionate Credentials	% share in firm "CYX"	Proportionate Credentials	% share in firm "P"	Proportionate Credential	% share in "ABCD"	Proportionate Contribution to "ABCD"
<b>A</b>	10%	10% of 10Cr. = <b>1.0 Cr.</b>	-	-	-	-	40%	40% of 1 Cr = <b>=0.4Cr</b>
<b>B</b>	20%	20% of 10Cr. = <b>2.0 Cr.</b>	-	-	-	-	30%	30% of 2 Cr. = <b>0.6 Cr</b>
<b>C</b>	-	-	50%	50% of 5 Cr= <b>2.5Cr</b>	-	-	20%	20% of 2.5Cr. = <b>0.5Cr.</b>
<b>D</b>	-	-	-	-	100%	100% of 2Cr= <b>2.0Cr</b>	10%	10% of 2Cr.= <b>0.20Cr</b>

#### **Evaluation of Technical Eligibility :-**

Any one of the partners of "ABCD" tendering firm viz A, B, C or D should satisfy the technical eligibility criterion on the basis of his/her proportionate share of credential in the earlier partnership firm reduced further by his percentage share in the tendering firm. As calculated in above table, the contribution of partners A, B, C & D towards the credentials of tendering firm "ABCD" will be taken as Rs. 0.40 cr., Rs. 0.60 cr., Rs. 0.50 cr., 0.20 cr respectively. Thus, in this example the firm "ABCD" is deemed to have executed one single work of maximum value of Rs 0.60 Cr. for the purpose of technical eligibility criteria.

#### **Evaluation of Financial Eligibility :-**

The arithmetic sum of the contribution of all the partners of tendering firm "ABCD" derived on the basis of their respective proportionate share in the earlier partnership firms reduced further by their respective percentage share in the tendering firm, in this example will be taken as Rs. 1.70 Cr. (i.e.  $A + B + C + D = 0.4 + 0.60 + 0.50 + 0.20 = 1.70$  cr.). Thus, in this example, the firm "ABCD" is deemed to have received contractual payments of Rs 1.70 Cr. for the purpose of financial eligibility criteria.

**1.1.5 The participation as Joint Venture shall be governed by clause No.65 of General Conditions of Contract (GCC).**

**1.1.6 Validity Of Tender**

Tenderer shall keep his offer open for a minimum period of 120 days from the date of opening of the tender or as mentioned in the Tender notice.

**1.1.7 Earnest Money –**

- a) The tender must be accompanied by Earnest Money of Rs 30,00,000/-(Thirty Lacs only ) in favour of '**Dedicated Freight Corridor Corporation of India Limited, payable at Ambala**' deposited in any of the forms as mentioned in 1.1.7(c), failing which the tender will not be considered.
- b) The earnest money shall remain deposited with the DFCCIL for the period of validity of the offer prescribed in this tender i.e.120 day from the date of opening of tender. If the validity of the offer is extended, the validity of earnest money should also be extended failing which the offer after the expiry of the aforesaid period may not be considered by the DFCCIL.
- c) The Earnest money should be in any of the following forms:  
The Earnest money should be in the form of "Deposit receipts, pay orders or Banker's cheque / Demand Draft executed by state bank of India or any of the Nationalized Banks or by a schedule bank" or in any form mentioned below:
  - i. Government securities at 5% below the market value
  - i. Deposit receipts or demand drafts of the Nationalized Bank
  - ii. A deposit in the Post Office Saving Bank
  - iii. National Savings Certificates
  - iv. Twelve Year National Defence Certificates
  - v. Ten Year Defence Deposits
  - vi. National Defence Bonds
  - vii. National Savings Certificates,
  - viii. Time Deposit Account which came into force on 16.03.1970 and notified under Ministry of Finance, Notification No.F3(7)NS/70, dated 28.02.70
  - ix. IRFC Bonds

**Note: (v) to (vii) – these Certificates/Bonds may be accepted at their surrender value.**

- d) It shall be understood that the tender documents have been sold/issued to the tenderer and the tenderer is permitted to tender in consideration of stipulation on his part, that after submitting his tender he will not resile from his offer or modify the terms and conditions, thereof in a manner not acceptable to the Employer. Should

the tenderer fail to observe or comply with the said stipulation, the aforesaid amount shall be liable to be forfeited to the DFCCIL.

- e) The earnest money of the unsuccessful tenderer(s) will, save as here-in-before provided, be returned to the unsuccessful tenderer(s) within a reasonable time but the DFCCIL shall not be responsible for any loss or depreciation that may happen for the due performance of the stipulation to keep the offer open for the period specified in the tender documents or to the earnest money while in their possession nor be liable to pay interest thereon.

**NOTE: No interest shall be paid by DFCCIL on earnest money amount.**

**1.1.8 Execution of contract Agreement** – The Tenderer whose tender is accepted shall be required to appear in person at the office of the **Chief Project Manager/ Ambala, DFCCIL, Ambala Cantt** or if a firm or corporation, a duly authorized representative shall so appear and execute the contract documents within 15 days after notice that the contract has been awarded to him and Performance Guarantee has been deposited by him. Failure to do so shall constitute a breach of the agreement affected by the acceptance of the tender in which case the full value of the earnest money accompanying the tender shall stand forfeited without prejudice to any other rights or remedies.

In the event of any Tenderer whose tender is accepted shall refuse to execute the contract documents as herein before provided, the DFCCIL may determine that such Tenderer has abandoned the contract and there upon his tender and acceptance thereof shall be treated as cancelled and DFCCIL shall be entitled to forfeit the full amount of the earnest money.

**1.1.9 Security Deposit On Acceptance Of Tender:**

The Security deposit / rate of recovery / mode of recovery on acceptance of tender shall be as per the Para 16(1)-(3) of General Conditions of Contract (GCC).

**1.1.10 Tenderer's Address**

The tenderer should state in the tender his postal address legibly and clearly. Any communication sent in time, to the tenderer by post at his said address shall be deemed to have reached the tenderer duly and in time. Important documents should be sent by Registered post/ speed post.

**1.1.11 Right of DFCCIL to deal with Tenders**

- a) The DFCCIL reserves the right of not to invite tenders for any of DFCCIL work or works or to invite open or limited tenders and when tenderers are called to accept a tender in whole or in part or reject any tender or all tenders without assigning reasons for any such action.

- b) The authority for the acceptance of the tender will rest with the DFCCIL. It shall not be obligatory on the said authority to accept the lowest tender or any other tender and no tenderer(s) shall demand any explanation for the cause of rejection of his/their tender nor the DFCCIL undertake to assign reasons for declining to consider or reject any particular tender or tenders.

### 1.1.12 (i) Eligibility criteria

#### (A) Technical Eligibility Criteria

Criteria Requirement	Compliance Requirement		Documents
	Single Entity	Joint venture All parties combined	Submission Requirements
(1)	(2)	(3)	(4)
<p>The Tenderer should have successfully completed at least one similar* single work for a minimum value of 35% of advertised tender value of work in the last three financial years i.e. current Financial year and three previous financial years (with reference to the deadline for submission of tender).</p> <p><b>*The meaning of “similar work” for this work is “Construction of Residential and service buildings in RCC Raft/Pile/Open foundations and Framed/Load bearing Structures.”</b></p>	Must meet requirement	Existing JV or Lead partner must meet requirement	The copy of completion certificate shall be submitted.

**Note:** a) Value of completed work done by a member in an earlier JV Firm shall be reckoned only to the extent of the concerned member's share in that JV

firm for the purpose of satisfying his/her compliance to the above mentioned technical eligibility criteria in the tender under consideration.

b) For Partnership firm Technical eligibility shall be evaluated as per clause 1.1.4.3.

**(B): Financial Eligibility Criteria**

Criteria Requirement	Compliance Requirement		Documents
	Single Entity	Joint venture All parties combined	Submission Requirements
(1)	(2)	(3)	(4)
The tenderer should have received total payment against satisfactory execution of all completed/ongoing works of all types (not confined to only similar works) during preceding three Financial years i.e. current Financial year and three previous financial years (with reference to the deadline for submission of tender) of a value not less than 150% of the advertised cost of the work.	Must meet requirement	Must meet requirement	A certificate from auditor or audited balance sheet / TDS certificate/Form 16A issued by Income Tax department shall be submitted.

**Note:** a) Contractual payments received by a Member in an earlier JV firm shall be reckoned only to extent of the concerned member's share in that JV Firm for the purpose of satisfying compliance.

b) For Partnership firm financial eligibility shall be evaluated as per clause 1.1.4.3.

### 1.1.12 (ii) Credentials of Tenderer

The tenderer shall provide satisfactory evidence acceptable to DFCCIL to show that:

- (a) For Technical eligibility criteria, the details will be submitted in Form 2A. Supporting documents shall also be submitted.
- (b) For Financial eligibility criteria, the details will be submitted in Form 2B. Supporting documents shall also be submitted
- (c) The tenderer should submit attested copies of the certificates obtained from the agencies wherever the works have been completed successfully. These certificates should indicate the details of works carried out and successful commissioning of similar type of work executed by the tenderer.

**Certificate from Private individuals for whom such work is executed/being executed shall not be accepted. The credentials from Government or semi-government organisations shall only be considered.**

The following will be applicable for evaluating the eligibility:

- (i) Similar nature of work physically completed within the qualifying period, i.e. last three financial year and current financial year (even though the work might have commenced before the qualifying period) shall only be considered in evaluating the eligibility criteria:
- (ii) The total value of similar nature of work completed during the qualifying period and not the payment received within qualifying period alone, shall be considered. In case, the final bill of similar nature of work has not been passed and final measurements have not been recorded, the paid amount including statutory deductions is to be considered. If final measurements have been recorded and work has been completed with negative variation, then also the paid amount including statutory deductions is to be considered.  
However, if final measurements have been recorded and work has been completed with positive variation but variation has not been sanctioned, original agreement value or last sanctioned agreement value whichever is lower shall be considered for judging eligibility.
- (iii) As a proof of sufficient financial capacity and organizational resources, contractor should have received total payments against satisfactory execution of all completed /on-going works of all types (not confined to only similar works) during the last three financial years and in the current financial year (up to the date of submission of the tender) of a value not less than 150% of advertised cost.
- (iv) Tenderer shall submit a statement of contractual payments received during last three financial years and current financial year on the prescribed Performa as per Form-2B. The details shall be based on the form 16-A issued by the employer i.e. the certificate of deduction of tax at source as per Income Tax Act 1961. The photocopies of form 16-A shall be enclosed duly attested by Notary Public with seal and Notarial Stamp there on and a certificate from auditor or audited balance

sheet certified by Chartered Accountant .clearly indicating the contractual amount received duly attested by Notary Public with seal and Notarial Stamp thereon.

- v) a)The tenderer shall be considered disqualified/in-eligible if the Tenderer or any of its partners/ members of JV has suffered bankruptcy/insolvency or it is in the process of winding-up or there is a case of insolvency pending before any Court on the deadline of submission of Application.
- b) An undertaking by tenderer / all the partners of the Partnership firm/ members of JV shall be given that they have not been black listed or debarred by Railways or any other Ministry/Department of the Govt of India/any State Govt. from participation in tenders/contract on the date of opening of bids either in their individual capacity or in any firm in which they were/are partners. Concealment/wrong information in regard to above shall make the contract liable for determination under clause 62 of General Conditions of Contract and action will be taken as per clause 16(4)(d) of General Conditions of contract..

#### **1.1.13 Period of Completion**

The entire work is required to be completed in all respects within **14 months (Fourteen months)** from the date of issue of the acceptance letter. Time is the essence of contract. The contractor will be required to maintain steady and regular progress to the satisfaction of the Engineer to ensure that the work will be completed in all respects within the stipulated time.

#### **1.1.14 Deleted.**

**1.1.15** If the Tenderer/s deliberately gives any wrong information about credentials/documents in his/their tenders and thereby create(s) circumstances for acceptance of his/their tender, DFCCIL reserves the right to reject such tender at any stage, besides, shall suspend the business. The EMD of such tenderers shall also be forfeited.

#### **1.1.16 Deleted**

#### **1.1.17 Quantum of work and materials –**

The indicative schedule of quantities of various items of works is included in Financial bid.

**1.1.17.1 Variation in contract quantities** shall be dealt as per relevant para of GCC and Special Conditions of Contract (SCC)

#### **1.1.18 Employer not bound to accept any tender:**

The Employer shall not be bound to accept the lowest or any tender or to assign any reason for non - acceptance or rejection of a tender. The Employer reserves the right to accept any tender in respect of the whole or any portion of



the work specified in the tender papers or to reduce the work or to accept any tender for less than the tendered quantities without assigning any reason what so ever.

**1.1.19 Schedule of Prices**

Financial Bid, of the tender document lists out the Schedule of Prices for various items.

1.1.20 **Performance Guarantee** shall be required from successful bidders as per Para 1.2.12 of Special Conditions of Contract (SCC).

1.1.21 The tenderer shall furnish information for making payment through EFT/ECS.

**1.1.22 No Form C&D shall be issued to the contractor for this work.**

**1.1.23 Clarification of Tenderers**

- I. To assist in the evaluation of Tenders, DFCCIL may, at its discretion, ask the Tenderer for a clarification on the documents submitted by Tenderer. No change in price or substance of bid shall be sought, offered or permitted. Any clarification given by tenderer, not in response to the request by the Employer, shall not be considered. Both request for clarification from the DFCCIL and clarifications submitted by Tenderer shall be in writing.
- II. If a Tenderer does not provide clarifications and/or documents within the date and time set in the DFCCIL's request for clarifications, his Tender shall be evaluated on the basis of the information and documents submitted by him in his Tender.

\*\*\*\*\*

**PART - I**

**CHAPTER II**

- (A) GENERAL CONDITIONS OF CONTRACT**
- (B) SPECIAL CONDITIONS OF CONTRACT**

**(A) GENERAL CONDITIONS OF CONTRACT**

**DEFINITIONS AND INTERPRETATION**

**1.(1) Definition:-** In these General conditions of Contract, the following terms shall have the meaning assigned here under except where the context otherwise requires:-

- (a) "Railway" shall mean the President of the Republic of India or the Administrative Officers of the Railway/DFCCIL or of the Successor Railway/DFCCIL authorized to deal with any matters which these presents are concerned on his behalf.
- (b) "General Manager" shall mean the officer in-charge of the General Superintendence and Control of the Railway and shall also include the Managing Director/DFCCIL and shall mean and include their successors, of the successor Railway;
- (c) "Chief Engineer" shall mean the officer in-charge of the Engineering Department of Railway and shall also include Chief Engineer (Construction), Chief Signal and Telecommunication Engineer, Chief Signal and Telecommunication Engineer (Construction), Chief Electrical Engineer, Chief Electrical Engineer (Construction) /Chief Project Manager of DFCCIL.
- (d) "Divisional Railway Manager" shall mean the Officer in-charge of a Division of the Railway and shall also mean any officer nominated by Managing Director/DFCCIL and shall mean and include their successors of the successor Railway.
- (e) "Engineer" and Employer's Engineer shall mean the Divisional Engineer or the Executive Engineer, Divisional Signal & Telecommunication Engineer, Divisional Signal & Telecommunications Engineer (Construction), Divisional Electrical Engineer, Divisional Electrical Engineer (Construction), in executive charge of the works and shall include the superior officers of the Engineering, Signal & Telecommunication, and Electrical Department of Railway i.e., the Senior Divisional Engineer/Deputy Chief Engineer /Chief Engineer/Chief Engineer (Construction), Senior Divisional Signal & Telecommunication Engineer/Deputy Chief Signal & Telecommunication Engineer/Chief Signal & Telecommunication Engineer(Construction) /Senior Divisional Electrical Engineer/Deputy Chief Electrical Engineer/Chief Electrical Engineer (Construction, Chief Administrative Officer (Construction and Dy. Chief Project Manager of DFCCIL/ person or agency appointed by Employer (DFCCIL).
- (f) "Engineer's Representative" shall mean the Assistant Engineer, Assistant Signal and Telecommunication Engineer and Assistant Electrical Engineer, APM/PM/ of DFCCIL in direct charge of the work and shall include any Sr. Sec./Sec./Jr.

Engineer./Executive/Sr. Executive of DFCCIL of Civil Engineering/Signal and Telecommunication Engineering /Electrical Engineering Department appointed by the Railway/DFCCIL and shall mean and include the Engineer's Representative of the successor Railway/DFCCIL or the representative of Engineer defined in clause (e) above.

- (g) "Contractor" shall mean the person/Firm/Cooperative Society or Company / JV whether incorporated or not who enters into the contract with the Railway and shall include their executors, administrators, and successors and permitted assigns.
- (h) "Contract" shall mean and include the Agreement of Work Order, the accepted schedule of rates of the Schedule or Rates of Railway/DFCCIL modified by the tender percentage for items of work quantified, or not quantified, the General Conditions of Contract, the special conditions of contracts, if any, the drawings, the specifications, the special specifications, if any and tender forms, if any and all other documents included as part of contract.
- (i) "Works" shall mean the works to be executed in accordance with the contract.
- (j) "Specifications" shall mean the Specifications for materials and works referred / mentioned in tender documents.
- (k) "Schedule of rates of Railway" shall mean the schedule of rates issued under the authority of the Chief Engineer from time to time and also includes Rates specified in tender document.
- (l) "Drawing" shall mean the maps, drawings, plans and tracings or prints there of annexed to the contract and shall include any modifications of such drawings and further drawings as may be issued by the Engineer from time to time.
- (m) "Constructional Plant" shall mean all appliances or things of whatsoever nature required for the execution, completion or maintenance of the works or temporary works (as hereinafter defined) but does not include materials or other things intended to form or forming part of the permanent work.
- (n) "Temporary Works" shall mean all temporary works of every kind required for the execution completion and/or maintenance of the works.
- (o) "Site" shall mean the lands and other places on, under, in or through which the works are to be carried out and any other lands or places provided by the Railway for the purpose of the contract.
- (p) "Period of Maintenance" shall mean the defect liability period from the date of completion of the works as certified by the Engineer.

- (2) **Singular and Plural:-** Words importing the singular number shall also include the plural and vice versa where the context requires.
- (3) **Headings & marginal headings:-**The headings and marginal headings in these general conditions are solely for the purpose of facilitating reference and shall not be deemed to be part thereof or be taken into consideration in the interpretation or construction thereof or the contract.

## **GENERAL OBLIGATION**

- 2 (1) **Execution Co-relation and intent of contract Documents:-**The contract documents be signed in triplicate by the Railway DFCCIL and the Contractor. The contract documents are complementary, and what is called for by any one shall be as binding as if called for by all, the intention of the documents is to include all labour and materials, equipments and transportation necessary for the proper execution of work. Materials or work not covered by or properly inferable from any heading or class of the specifications shall not be supplied by the Railway/DFCCIL to the contractors unless distinctly specified in the contract documents. Materials or works described in words which so applied have a well known technical or trade meaning shall be held to refer to such recognized standards.
- (2) If a work is transferred from the jurisdiction of one Railway to another Railway or to a project authority or vice versa while contract is in subsistence, the contract shall be binding on the Contractor and the Successor Railway/Project in the same manner & take effect all respects as if the Contractor and the Successor Railway/Project were parties thereto from the inception and the corresponding officer or the Competent Authority in the Successor Railway/Project will exercise the same powers and enjoy the same authority as conferred to the Predecessor Railway/Project under the original contract/agreement entered into.
- (3) If for administrative or other reasons the contract is transferred to the Successor Railway the contract shall notwithstanding any things contained herein contrary there to, be binding on the Contractor and the Successor Railway in the same manner and take effect in all respect as if the Contractor and the Successor Railway had been parties thereto from the date of this contract.
- 3(1) **Law governing the contract:-**The contract shall be governed by the law for the time being in force in the Republic of India.
- (2) **Compliance to regulations and bye-laws:-**The contractor shall conform to the provision of any statute relating to the works and regulations and bye-laws of any location authority and of any water and lighting companies or undertakings, with whose system the work is proposed to be connected and shall before making any variation from the drawings or the specifications that may be necessitated by

so confirming give to the Engineer notice specifying the variation proposed to be made and the reasons for making the variation and shall not carry out such variation until he has received instructions from the Engineer in respect thereof. The contractor shall be bound to give all notices required by status, regulations or bye-laws as aforesaid and to pay all fees and taxes payable to any authority in respect thereof.

- (4) **Communications to be in writing :-** All notices, communications, reference and complaints made by the Railway or the Engineer or the Engineer's representative or the contractor interse concerning the work shall be in writing and no notice, communication, reference or complaint not in writing shall be recognized.
- (5) **Service of Notices on Contractors:-**The contractor shall furnish to the Engineer the name designation and address of his authorized agent and all complaints, notices, communications and references shall be deemed to have been duly given to the Contractor if delivered to the contractor or his authorized agent or left at or posted to the address so given and shall be deemed to have been so given in the case of posting on day on which they would have reached such address in the ordinary course of post or on the day on which they were so delivered or left. In the case of contract by partners, any change in the constitution of the firm shall be forthwith notified by the contractor to the Engineer.
- (6) **Occupation and use of land:-** No land belonging to or in the possession of the Railway shall be occupied by the Contractor without the permission of the Railway. The Contractor shall not use, or allow to be used, the site for any purposes other than that of executing the works. Whenever non-railway bodies/persons are permitted to use Railway premises with competent authority's approval, conservancy charges as applicable from time to time may be levied.
- (7) **Assignment or subletting of contract:-** The contractor shall not assign or sublet the contract or any part thereof or allow any person to become interested therein any manner what so ever without the special permission in writing of the Railway. Any breach of this condition shall entitle the Railway to rescind the contract under clause 62 of these conditions and also render the contractor liable for payment to the Railway in respect of any loss or damage arising or ensuing from such cancellation. Provided always that execution of the details of the work by petty contractor under the direct and personal supervision of the Contractor or his agent shall not be deemed to be sub-letting under this clause. The permitted subletting of work by the contractor shall not establish any contractual relationship between the sub-contractor and the Railway and shall not relieve the contractor of any responsibility under the contract.

- (8) **Assistance by the Railway for the Stores to be obtained by the Contractor:-**Owing to difficulty in obtaining certain materials (including Tools & Plant) in the market, the Railway may have agreed without any liability therefore to endeavour to obtain or assist the contractor in obtaining the required quantities of such materials as may be specified in the Tender. In the event of delay or failure in obtaining the required quantities of the aforesaid material the contractor shall not be deemed absolved of his own responsibility adjust progress of works including employment of labour and the Railway shall not in any way be liable for the supply of materials or for the non-supply thereof for any reasons whatsoever nor for any loss or damage arising in consequence of such delay or no supply.
- (9) **Railway Passes:-** No free Railway passes shall be issued by the Railway to the contractor or any of his employee/work.
- (10) **Carriage of materials:-**No forwarding orders shall be issued by the Railway for the conveyance of contractor's materials, tools and plant by Rail which may be required for use in the works and the contractor shall pay full freight charges at public tariff rates therefore.
- (11) **Deleted**
- (12) **Representation on Works:-** The contractor shall, when he is not personally present on the site of the works place and keep a responsible agent at the works during working hours who shall on receiving reasonable notice, present himself to the Engineer and orders given by the Engineer or the engineer's representative to the agent shall be deemed to have the same force as if they had been given to the Contractor. Before absenting himself, the contractor shall furnish the name and address of his agent for the purpose of this clause and failure on the part of the Contractor to comply with this provision at any time will entitle the Railway to rescind the contract under clause 62 of these conditions.
- (13) **Relics and Treasures:-** All gold, silver, oil and other minerals of any description and all precious stones, coins, treasures relics antiquities and other similar things which shall be found in or upon the site shall be the property of the Railway and the Contractor shall duly preserve the same to the satisfaction of the Railway and shall from time to time deliver the same to such person or persons as the Railway may appoint to receive the same.
- (14) **Excavated material:-**The contractor shall not sell or otherwise dispose of or remove except for the purpose of this contract, the sand, stones clay ballast, earth, rock or other substances or materials which may be obtained from any excavation made for the purpose of the works or any building or produced upon the site at the time of delivery of the possession thereof but all the substances, materials, buildings and produce shall be the property of the Railway provided

that the contractor may, with the permission of the Engineer, use the same for the purpose of the works either free of cost or pay the cost of the same at such rates as may be determined by the Engineer.

(15) **Indemnity by Contractors:-** The contractor shall indemnify and save harmless the Railway from and against all actions, suit proceedings losses, costs, damages, charges, claims and demands of every nature and description brought or recovered against the Railways by reason of any act or omission of the contractor, his agents or employees, in the execution of the works or in his guarding of the same. All sums payable by way of compensation under any of these conditions shall be considered as reasonable compensation to be applied to the actual loss or damage sustained, and whether or not any damage shall have been sustained.

16 (1) **Security Deposit:-** The earnest money deposited by the contractor with this tender will be retained by the Railways as part of security for the due and faithful fulfillment of the contract by the contractor. The balance to make up the security deposit, the rates for which are given below, may be deposited by the contractor in cash or may be recovered by percentage deduction from the contractor's "on account" bills. Provided also that in case of defaulting contractor the Railway may retain any amount due for payment to the contractor on the pending "on account bills" so that the amounts so retained may not exceed 10% of the total value of the contract.

16. (2) Unless otherwise specified in the special conditions, if any, the Security Deposit/rate of recovery/mode of recovery shall be as under:

- (a) Security Deposit for each work should be 5% of the contract value.
- (b) The rate of recovery should be at the rate of 10% of the bill amount till the full security deposit is recovered.
- (c) Security Deposits will be recovered only from the running bills of the contract and no other mode of collecting SD such as SDE in the form of instruments like BG (except Note (ii) below); FD etc. shall be accepted towards Security Deposit. Security deposit shall be returned to the contractor after the expiry of the Defect Liability Period in all the cases other than Note (i) mentioned below and after passing the final bill based on No Claim Certificate with the approval of the Competent Authority. The Competent Authority shall normally be the authority who is competent to sign the contract. The certificate, inter alia, should mention that the work has been completed in all respects and that all the contractual obligations have been fulfilled by the contractor and that there is no due from the contractor to Railways against the contract concerned. Before releasing the SD, an unconditional and unequivocal no claim certificate from the contractor concerned should be obtained.



**Note:**

- (i) After the work is physically completed, security deposit recovered from the running bills of a contractor can be returned to him if he so desires, in lieu of FDR/irrevocable Bank Guarantee for equivalent amount to be submitted by him.
- (ii) In case of contracts of value Rs.50 crore and above, irrevocable Bank Guarantee can also be accepted as a mode of obtaining security deposit.

**16.(3)** No interest will be payable upon the Earnest Money and Security Deposit or amounts payable to the contractor under the contract, but Government Securities deposited in terms of Sub-clause (1) of this clause will be payable with interest accrued thereon.

**16 (4) Performance Guarantee (P.G)**

The procedure for obtaining Performance Guarantee is outlined below:

- (a) The successful bidder may give Performance Guarantee amounting to 5% of the contract value in any of the following forms:-
  - (i) Irrevocable Bank Guarantee
  - (ii) Government Securities including State Loan Bonds at 5 percent below the market value
  - (iii) Deposit Receipts, Pay Orders, Demand Draft and Guarantee Bonds. These forms of Performance Guarantee could be either of the State Bank of India or of any of the Nationalized Banks;
  - (iv) Guarantee Bonds executed or Deposits Receipts tendered by all Scheduled Banks;
  - (v) A Deposit in the Post Office Saving Bank;
  - (vi) A deposit in the National Savings Certificates.
  - (vii) Twelve years National Defence Certificates;
  - (viii) Ten years Defence Deposits;
  - (ix) National Defence Bonds; and
  - (x) Unit Trust Certificates at 5 per cent below market value or at the face value whichever is less.

Also FDR in favour of '**Dedicated Freight Corridor Corporation of India Limited**' (free from any encumbrance) may be accepted.

**Note:** The instruments as listed above will also be acceptable for Guarantees in case of Mobilization advance.

- (b) The performance Guarantee shall be submitted by the successful bidder after the letter of acceptance has been issued, but before signing of the agreement. The agreement should normally be signed within 15 (fifteen) days after the issue of LOA and the Performance Guarantee shall also be submitted with this time limit. This guarantee shall be initially valid up to the stipulated date of completion plus 60 days beyond that. In case, the time limit for completion of work gets extended, the contractor shall give the validity of Performance Guarantee extended to cover such extended time for completion of work plus 60 days.
- (c) The performance Guarantee (PG) shall be released after the physical completion of the work based on the 'completion certificate' issued by the competent authority stating that the contractor has completed the work in all respects satisfactorily. The security deposit, however, shall be released only after the expiry of the defect liability period and after passing the final bill based on 'No Claim Certificate'.
- (d) Wherever the contract is rescinded, the security deposit shall be forfeited and the Performance Guarantee shall be encashed and the balance work shall be got done independently without risk and cost of the failed contractor, the failed contractor shall be debarred from participating in the tender for executing the balance work. If the failed contractor is a JV or a partnership firm, then every member/partner of such a firm shall be debarred from participating in the tender for the balance work either in his/her individual capacity or as a partner of any other JV/partnership firm.
- (e) The Engineer shall not make a claim under the Performance Guarantee except for amounts to which the DFCCIL is entitled under the contract (no withstanding and/or without prejudice to any other provisions in the contract agreement) in the event of:
  - (i) Failure by the contractor to extend the validity of the Performance Guarantee as described herein above, in which event the Engineer may claim the full amount of the Performance Guarantee.
  - (ii) Failure by the contractor to pay President of India any amount due, either as agreed by the contractor or determined under any of the Clauses/conditions of the agreement, within 30 days of the service of the notice to the effect by Engineer
  - (iii) The contract being determined or rescinded under provision of the GCC the Performance Guarantee shall be forfeited in full and shall be absolutely at the disposal of the President of India.

17. **Force Majeure Clause:-** If at any time, during the continuance of this contract, the Performance in whole or in part by either party of any obligation under this contract shall be prevented or delayed by reason of any war, hostility, acts of public enemy, civil commotion, sabotage, serious loss or damage by fire, explosions, epidemics, strikes, lockouts or act of God (hereinafter, referred to events) provided, notice of the happening of any such event is given by either party to the other within 30 days from the date of occurrence thereof, neither party shall by reason of such event, be entitled to terminate this contract nor shall either party have any claim for damages against the other in respect of such non-performance of delay in performance, and works under the contract shall be resumed as soon as practicable after such event has come to an end or ceased to exist, and the decision of the Engineer as to whether the works have been so resumed or not shall be final and conclusive, PROVIDED FURTHER that if the performance in whole or in part of any obligation under this contract is prevented or delayed by reason of any such event for a period exceeding 120 days, either party may at its option terminate the contract by giving notice to the other party.
- 17-A** Subject to any requirement in the contract as to completion of any portions or portions of the works before completion of the whole, the contractor shall fully and finally complete the whole of the works comprised in the contract (with such modifications as may be directed under conditions of this contract) by the date entered in the contract or extended date in terms of the following clauses:-
- i) If any modifications have been ordered which in the opinion of the Engineer have materially increased the magnitude of the work, then such extension of the contracted date of completion may be granted as shall appear to the Engineer to be reasonable in the circumstances, provided moreover that the Contractor shall be responsible for requesting such extension of the date as may be considered necessary as soon as the cause thereof shall arise and in any case not less than one month before the expiry of the date fixed for completion of the works.
  - ii) If in the opinion of the Engineer the progress of work has any time been delayed by any act or neglect of Railway's employees or by other contractor employed by the Railway under sub-clause (4) of clause 20 of these conditions or in executing the work not forming part of the contract but on which contractor's performance necessarily depends or by reasons of proceeding taken or threatened by or dispute with adjoining or to neighboring owners or public authority arising otherwise through the Contractor's own default etc. or by the delay authorized by the Engineer pending arbitration or in consequences of the contractor not having received in due time necessary instructions from the Railway for which he shall have specially applied in writing to the Engineer or his authorized representative then upon happening of any such even causing delay, the contractor shall immediately give notice thereof in writing to the Engineer within 15 days of such happening but shall nevertheless make constantly his best

endeavours to bring down or make good the delay and shall do all that may be reasonably required of him to the satisfaction of the Engineer to proceed with the works. The contractor may also indicate the period for which the work is likely to be delayed and shall be bound to ask for necessary extension of time. The Engineer on receipt of such request from the contractor shall consider the same and shall grant such extension of time as in his opinion is reasonable having regard to the nature and period of delay and the type and quantum of work affected thereby. No other compensation shall be payable for works so carried forward to the extended period of time., the same rates, terms and conditions of contract being applicable as if such extended period of time was originally provided in the original contract itself.

- (iii) In the event of any failure or delay by the Railway to hand over the Contractor possession of the lands necessary for the execution of the works or to give the necessary notice to commence the works or to provide the necessary drawings or instructions or any other delay caused by the Railway due to any other cause whatsoever, then such failure or delay shall in no way affect or vitiate the contract or alter the character thereof or entitle the contractor to damages or compensation therefore, but in any such case, the Railway may grant such extension or extensions of the completion date as may be considered reasonable.

**17-B Extension of time for delay due to contractor:-**

The time for the execution of the work or part of the works specified in the contract documents shall be deemed to be the essence of the contract and the works must be completed not later than the date(s) as specified in the contract. If the contractor fails to complete the works within the time as specified in the contract for the reasons other than the reasons specified in clause 17 and 17-A, the Railway may, if satisfied that the works can be completed by the contractor within reasonable short time thereafter, allow the contractor for further extension of time as the Engineer may decide. On such extension the Railway will be entitled without prejudice to any other right and remedy available on that behalf, to recover from the contractor as agreed damages and not by way of penalty a sum equivalent to ½ of 1% of the contract value of the works for each week or part of the week.

For the purpose of this clause, the contract value of the works shall be taken as value of work as per contract agreement including any supplementary work order/contract agreement issued. Provided also, that the total amount of liquidated damages under this condition, shall not exceed the under noted percentage value or of the total value of the item or groups of items of work for which a separate distinct completion period is specified in the contract.

- i) For contract value up to Rs.2 lakhs - 10% of the total value of the contract

- ii) For contracts valued above Rs.2 lakhs- 10% of the first Rs.2 lakhs and 5% of the balance

Further competent authority while granting extension to the currency of contract under clause 17(B) of GCC may also consider levy of token penalty as deemed fit based on the merit of the case.

Provided further, that if the Railway is not satisfied that the works can be completed by the Contractor and in the event of failure on the part of the contractor to complete the work within further extension of time allowed as aforesaid, the Railway shall be entitled without prejudice to any other right or remedy available in that behalf, to appropriate the contractor's security deposit and rescind the contract under clause 62 of these conditions, whether or not actual damage is caused by such default.

**18(1) Illegal Gratification:-**Any bribe, commission, gift or advantage given, promised or offered by or on behalf to the contractor or his partner, agent or servant or, anyone on his behalf, to any officer or employee of the Railway, or to any person on his behalf in relation to obtaining or execution of this or any other contract with the Railway shall, in addition to any criminal liability which he may incur, subject contractor to the rescission of the contract and all other contracts with the Railway and to the payment of any loss or damage resulting from such decision and the Railway shall be entitled to deduct the amounts so payable from any moneys due to the Contractor(s) under this contract or any other contracts with the Railway.

**(2)** The contractor shall not lend or borrow from or have or enter into any monetary dealings and transactions either directly or indirectly with any employee of the Railway and if he shall do so, the Railway shall be entitled forthwith to rescind the contract and all other contracts with the Railway. Any question or dispute as to the commission or any such offence or compensation payable to the Railway under this clause shall be settled by the General Manager of the Railway, in such a manner as he shall consider fit and sufficient and his decision shall be final and conclusive. In the event of rescission of the contract under this clause, the contractor will not be paid any compensation whatsoever except payments for the work done up to the date of rescission.

### EXECUTION OF WORKS

**19(1) Contractor's understanding:-**It is understood and agreed that the contractor has, by careful examination, satisfied himself as to the nature and location of the work, the conformation of the ground, the character, quality and quantity of the materials to be encountered, the character of equipment and facilities needed preliminary to and during the progress of the works, the general and local

conditions, the labour conditions prevailing therein and all other matters which can in any way affect the works under the contract.

- (2) **Commencement of works:-**The contractor shall commence the works within 15 days after the receipt by him of an order in writing to this effect from the Engineer and shall proceed with the same with due expedition and without delay.
- (3) **Accepted Programme of work:-**The contractor who has been awarded the work shall as soon as possible but not later than 30 days after the date of receipt of the acceptance letter in respect of contracts with initial completion period of two years or less or not later than 90 days for other contracts have to submit the detailed programme of work indicating the time schedule of various items of works in the form of Bar Chart/PERT/CPM. He shall also submit the details of organization (in terms of labour and supervisors) plant and machinery, that he intends to utilize (from time to time) for execution of the work within stipulated date of completion. The programme of work amended as necessary by discussions with the Engineer, shall be treated as the agreed programme of the work for the purpose of this contract and the contractor shall endeavour to fulfill this programme of work. The progress of work will be watched accordingly the liquidated damages will be with reference to the overall completion date. Nothing stated herein shall preclude the contractor in achieving earlier completion of item or whole of the works than indicated in the programme.
- (4) **Setting out of works:-** The contractor shall be responsible for the correct setting out of all works in relation to original points, lines and levels of reference at his cost. The contractor shall execute the work true to alignment, grade, levels and dimensions as shown in the drawing and as directed by the Engineer's representative and shall check these at frequent intervals. The contractor shall provide all facilities like labour and instruments and shall co-operate with the Engineer's representative to check all alignment, grades, levels and dimensions. If, at any time, during the progress of the works any error shall appear or arise in any part of the work, the contractor, on being required so to do by the Engineer's representative shall, at his own cost rectify such errors, to the satisfaction of the Engineer's representative. Such checking shall not absolve the contractor of his own responsibility of maintaining accuracy in the work. The contractor shall carefully protect and preserve all bench marks, sight rails, pegs and other things used in setting out the work.
- 20(1) Compliance to Engineer's instructions:-**The Engineer shall direct the order in which the several parts of the works shall be executed and the contractor shall execute without delay all orders given by the Engineer from time to time but the contractor shall not be relieved thereby from responsibility for the due performance of the works in all respects.

- (2) **Alterations to be authorized:-**No alterations in or additions to or omissions or abandonment of any part of the works shall be deemed authorized, except under instructions from the Engineer, and the contractor shall be responsible to obtain such instructions in each and every case in writing from the Engineer.
- (3) **Extra works:-** Should works over and above those included in the contract require to be executed at the site, the contractor shall have no right to be entrusted with the execution of such works which may be carried out by another contractor or contractors or by other means at the option of the Railway.
- (4) **Separate contracts in connection with works:-** The Railway shall have the right to let other contracts in connection with the works. The contractor shall afford other contractors reasonable opportunity for the storage of their materials and the execution of their works and shall properly connect and coordinate his work with theirs. If any part of the contractors work depends for proper execution or result upon the work of another contractor(s), the contractor shall inspect and promptly report to the Engineer any defects in such works that render it unsuitable for such proper execution and results. The contractor's failure so to inspect and report shall constitute an acceptance of the other contractor's work as fit and proper for the reception of his work, except as to defects which may develop in the other contractor's work after the execution of his work.
- 21 Instruction of Engineer's Representative:-** Any instructions or approval given by the Engineer's representative to contractor in connection with the works shall bind the contractor as through it had been given by the Engineer provided always as follows:
- (a) Failure of the Engineer's representative to disapprove any work or materials shall not prejudice, the power of the Engineer thereafter to disapprove such work or material and to order the removal or breaking up thereof.
- (b) If the Contractor shall be dissatisfied by reason of any decision of the Engineer's representative, he shall be entitled to refer the matter to the Engineer who shall there upon confirm or vary such decision.
- 22(1) Adherence to specifications and drawings:-** The whole of the works shall be executed in perfect conformity with the specifications and drawings of the contract. If contractor performs any works in a manner contrary to the specifications or drawings or any of them and without such reference to the Engineer he shall bear all the costs arising or ensuing therefore and shall be responsible for all loss to the Railway.
- (2) **Drawings and specifications of the works:-**The contractor shall keep one copy of drawings and specifications at the site, in good order, and such contract documents as may be necessary available to the Engineer or the Engineer's representative.

- (3) **Ownership of drawings and specifications:-**All drawings and specifications and copies thereof furnished by the Railway to the Contractor are deemed to be the property of the Railway. They shall not be used on other works and with the exception of the signed contract set, shall be returned by the contractor to the Railway on completion of the work or termination of the contract.
- (4) **Compliance with Contractor's request for details:-** The Engineer shall furnish with reasonable promptness, after receipt by him of the contractor's request for the same, additional instructions by means of drawings or otherwise, necessary for the proper execution of the works or any part thereof. All such drawing and instructions shall be consistent with the contract Documents and reasonably inferable there from.
- (5) **Meaning and intent of specification and drawings:-** If any ambiguity arises as to the meaning and intent of any portion of the specifications and drawings or as to execution or quality of any work or material, or as to the measurements of the works the decision of the Engineer thereon shall be final subject to the appeal (within 7 days of such decision being intimated to the contractor) to the Chief Engineer who shall have the power to correct any errors, omissions, or discrepancies in aforementioned items and whose decision in the matter in dispute or doubt shall be final and conclusive.
- 23 **Working during night:-** The contractor shall not carry out any work between sun-set and sun-rise without the previous permission of the Engineer.
24. **Damage to Railway property or private life and property:-**The contractor shall be responsible for all risk to the work and for trespass and shall make good at his own expense all loss or damage whether to the works themselves or to any other property of the Railway or the lives, persons or property of others from whatsoever cause in connection with the works until they are taken over by the Railway and this although all reasonable and proper precautions may have been taken by the contractor, and in case the Railway shall be called upon to make good any costs, loss or damages, or to pay an compensation, including that payable under the provisions of the Workmen's Compensation Act or any statutory amendments thereof to any person or persons sustaining damages as aforesaid by reason of any act, or any negligence or omissions on the part of the contractor the amount of any costs or charges including costs and charges in connection with legal proceedings, which the Railway may incur in reference thereto, shall be charged to the contractor. The Railway shall have the power and right to pay or to defend or compromise any claim of threatened legal proceedings or in anticipation of legal proceedings being instituted consequent on the action or default of the contractor, to take such steps as may be considered necessary or desirable to ward off or mitigate the effect of such proceedings, charging to contractor, as aforesaid any sum or sums of money which may be paid and any expenses whether for reinstatement or otherwise



which may be incurred and the propriety of any such payment, defence or compromise, and the incurring of any such expenses shall not be called in question by the contractor.

- 25. Sheds, stores houses and Yards:-**The contractor shall at his own expense provide himself with sheds, stores houses and yards in such situations and in such numbers as in the opinion of the Engineer is requisite for carrying on the works and the contractor shall keep at each such sheds, stores houses and yard a sufficient quantity of materials and plant in stock as not to delay the carrying out of the works with due expedition and the Engineer and the Engineer's representative shall have free access to the said sheds, store houses and yards at any time for the purpose of inspecting the stock of materials or plant so kept in hand, and any materials or plan which the Engineer may object to shall not be brought upon or used in the works, but shall be forthwith removed from the sheds, store houses or yards by the contractor. The contractor shall at his own expenses provide and maintain suitable mortar mills, soaking vats or any other equipments necessary for the execution of the works.
- 26. Provision of efficient and competent staff:-**The contractor shall place and keep on the works at all times efficient and competent staff to give the necessary directions to his workmen and to see that they execute their work in sound and proper manner and shall employ only such supervisors, workmen and labourers in or about the execution of any of these works as are careful and skilled in the various trades and callings. The contractor shall at once remove from the works any agents, permitted sub-contractor, supervisor, workman or labourer who shall be objected to by the Engineer and if and whenever required by the Engineer, he shall submit a correct return showing the names of all staff and workmen employed by him. In the event of the Engineer being of the opinion that the contractor is not employing on the works a sufficient number of staff and workmen as is necessary for the proper completion of the works within the time prescribed, the contractor shall forthwith on receiving intimation to this effect take on the additional number of staff and labour specified by the Engineer within seven days of being so required and failure on the part of the contractor to comply with such instructions will entitle the Railway to rescind the contract under clause 62 of these conditions.
- 27(1) Workmanship and testing:-**The whole of the works and/or supply of materials specified and provided in the contract or that may be necessary to be done in order to form and complete any part thereof shall be executed in the best and most substantial workman like manner with materials of the best and most approved quality of their respective kinds, agreeable to the particulars contained in or implied by the specifications and as referred to in and represented by the drawings or in such other additional particulars, instructions and drawings may be found requisite to be given during the carrying on of the works and to the entire satisfaction of the Engineer according to the instructions and directions

which the contractors may from time to time receive from the Engineer. The materials may be subjected to tests by means of such machines, instruments and appliances as the Engineer may direct and wholly at the expense of the contractor.

**(2) Removal of improper work and materials:-**The Engineer or the Engineer's Representative shall be entitled to order from time to time:

- (a) The removal from the site within the time specified in the order of any materials which in his opinion are not in accordance with the specifications or drawings.
- (b) The substitution of proper and suitable materials, and
- (c) The removal and proper re-execution, notwithstanding any previous tests thereof or on account payments therefore, of any work which in respect of materials or workmanship; is not in his opinion in accordance with the specifications and in case of default on the part of the contractor in carrying out such order the Railway shall be entitled to rescind the contract under clause 62 of these conditions.

**28. Facilities for inspection:-**The contractor shall afford the Engineer and the Engineer's Representative every facility for entering in and upon every portion of the work at all hours for the purpose of inspection or otherwise and shall provide all labour, materials, planks, ladders, pumps, appliances and things of every kind required for the purpose and the Engineer and the Engineer's Representative shall at all times have free access to every part of the works and to all places at which materials for the works are stored or being prepared.

**29. Examination of work before covering up:-** The contractor shall give 7 days' notice to the Engineer or the Engineer's representative whenever any work or materials are intended to be covered up in the earth, in bodies or walls or otherwise to be placed beyond the reach of measurements in order that the work may be inspected or that correct dimensions may be taken before being so covered, placed beyond the reach of measurement in default whereof, the same shall at the option of the Engineer or the Engineer's representative be uncovered and measured at the contractor's expense or no allowance shall be made for such work or materials.

**30. Temporary Works:-** All temporary works necessary for the proper execution of the works shall be provided and maintained by the contractor and subject to the consent of the Engineer shall be removed by him at his expenses when they are no longer required and in such manner as the Engineer shall direct. In the event of failure on the part of the contractor to remove the temporary works, the Engineer will cause them to be removed and cost as incurred by supervision and other incidental charges shall be recovered from the contractor. If temporary huts

are provided by the contractor on the Railway land for labour engaged by him for the execution of works, the contractor shall arrange for handing over vacant possession of the said land after the work is completed; if the contractor's labour refuse to vacate, and have to be rejected by the Railway necessary expenses incurred by the Railway in connection therewith shall be borne by the contractor.

**31(1) Contractor to supply water for works:-** Unless otherwise provided in the contract, the contractor shall be responsible for the arrangements to obtain supply of water necessary for the works.

**31 (2) Deleted**

**31(3) Deleted**

**31 (4) (a) Contractor to arrange supply of Electric power for works:-** Unless otherwise provided in the contract, the contractor shall be responsible for arrangements to obtain supply of electric power for the works.

**31 (4)(b) Deleted**

**32. Property in materials and plant:-** The materials and plant brought by the Contractor upon the site or on the land occupied by the Contractor in connection with the works and intended to be used for the execution thereof shall immediately, they are brought upon the site of the said land, be deemed to be the property of the Railway. Such of them as during the progress of the works are rejected by the Engineer under Clause 25 of these conditions or are declared by him not to be needed for the execution of the works or such as on the grant of the certificate of completion remain unused shall immediately on such rejection, declaration or grant cease to be deemed the property of the Railway and the Contractor may then (but not before) remove them from the site or the said land. This clause shall not in any way diminish the liability of the Contractor nor shall the Railway be in any way answerable for any loss or damage which may happen to or in respect of any such materials or plant either by the same being lost, stolen, injured or destroyed by fire, tempest or otherwise.

**33. (1) Tools, Plant and Materials Supplied by Railway:-** The Contractor shall take all reasonable care of all tools, plant and materials or other property whether or a like description or not belonging to the Railway and committed to his charge for the purpose of the works and shall be responsible for all damage or loss caused by him, his agents, permitted subcontractor, or his workmen or others while they are in his charge. The Contractors shall sign accountable receipts for tools, plants and materials made over to him by the engineer and on completion of the works shall hand over the unused balance of the same to the Engineer in good order and repair, fair wear and tear excepted, and shall be responsible for any failure to account for the same or any damage done thereto.

- (2) Hire of Railway's Plant:-** The Railway may hire to the Contractor such plant as concrete mixers, compressors and portable engines for use during execution of the works on such terms as may be specified in the special conditions or in a separate agreement for Hire of Plant.
- 34. (1) Precaution during progress of works:-** During the execution of works, unless otherwise specified, the Contractor shall at his own cost provide the materials for and execute all shoring, timbering and strutting works as is necessary for the stability and safety of all structures, excavations and works and shall ensure that no damage, injury or loss is caused or likely to be caused to any person or property.
- (2) Roads and Water courses:-** Existing roads or water courses shall not be blocked cut through, altered, diverted or obstructed in any way by the Contractor, except with the permission of the Engineer. All compensations claimed for any unauthorized closure, cutting through, alterations, diversion or obstruction to such roads or water courses by the Contractor or his agent or his staff shall be recoverable from the Contractor by deduction from any sums which may become due to him in terms of contract, or otherwise according to law.
- (3) Provision of access to premises:-** During progress of work in any street or thoroughfare, the Contractor shall make adequate provision for the passage of traffic, for securing safe access to all premises approached from such street or thoroughfare and for any drainage, water supply or means of lighting which may be interrupted by reasons of the execution of the works and shall erect and maintain at his own cost barriers, lights and other safeguards as prescribed by the Engineer, for the regulation of the traffic, and provide watchmen necessary to prevent accidents. The works shall in such cases be executed night and day if so ordered by the Engineer and with such vigour so that the traffic way be impeded for as short a time as possible.
- (4) Safety of Public:-** The Contractor shall be responsible to take all precautions to ensure the safety of the public whether on public or Railway property and shall post such look out men as may in the opinion of the Engineer be required to comply with regulations pertaining to the work.
- 35. Use Of Explosives:** Explosives shall not be used on the works or on the site by the Contractor without the permission of the Engineer and then only in the manner and to the extent to which such permission is given. Where explosives are required for the works, they shall be stored in a special magazine to be provided by and at the cost of the Contractor in accordance with the Explosive Rules. The Contractor shall obtain the necessary license for the storage and the use of explosives and all operations in which or for which explosives are employed shall be at the sole risk and responsibility of the Contractor and the Contractor shall indemnify the Railway in respect thereof.

**36. (1) Suspension of works:-** The Contractor shall on the order of the Engineer, suspend the progress of the works or any part thereof for such time or times and in such manner as the Engineer may consider necessary and shall during such suspension properly protect and secure the work so far as is necessary in the opinion of the Engineer. If such suspension is:-

- (a) Provided for in the contract, or
- (b) Necessary for the proper execution of the works or by the reason of weather conditions or by some default on the part of the Contractor, and/or
- (c) Necessary for the safety of the works or any part thereof.

**(2)** The Contractor shall not be entitled to the extra costs, if any, incurred by him during the period of suspension of the works, but in the event of any suspension ordered by the Engineer for reasons other than aforementioned and when each such suspensions and to such compensations as the Engineers may consider proper having regard to the period of such suspensions and to such compensations as the Engineer may consider reasonable in respect of salaries or wages paid by the Contractor to his employees during the periods of such suspension.

**(3) Suspension lasting more than 3 months:-** If the progress of the works or any part thereof is suspended on the order of the Engineer for more than three months at a time, the Contractor may serve a written notice on the Engineer requiring permission within 15 days from the receipt thereof to proceed with the works or that part thereof in regard to which progress is suspended and if such permission is not granted within that time the Contractor by further written notice so served may, but is not bound to, elect to treat the suspension where it affects part only of the works as an omission of such part or where it affects the whole of the works, as an abandonment of the contract by the Railway.

**37. Rates for items of works:-** The rates, entered in the accepted Schedule of Rates of the Contract are intended to provide for works duly and properly completed in accordance with the general and special (if any) conditions of the contract and the specifications and drawings together with such enlargements, extensions, diminutions, reductions, alterations or additions as may be ordered in terms of Clause 42 of these conditions and without prejudice to the generality thereof and shall be deemed to include and cover superintendence and labour, supply, including full freight, of materials, stores, patterns, profiles, moulds, fittings, centering, scaffolding, shoring props, timber, machinery, barracks, tackle, roads, pegs, posts, tools and all apparatus and plant required on the works, except such

tools, plant or materials as may be specified in the contract to be supplied to the Contractor by the Railway, the erection, maintenance and removal of all temporary works and, buildings, all watching, lighting, bailing, pumping and draining, all prevention of or compensation for trespass, all barriers and arrangements for the safety of the public or of employees during the execution of works, all sanitary and medical arrangements for labour camps as may be prescribed by the Railway, the setting of all work and of the construction, repair and upkeep of all centre lines, bench marks and level pegs thereon, site clearance, all fees duties, royalties, rent and compensation to owners for surface damage or taxes and impositions payable to local authorities in respect of land, structures and all material supplied for the work or other duties of expenses for which the Contractor may become liable or may be put to under any provision of law for the purpose of or in connection with the execution of the contract, and all such other incidental charges or contingencies as may have been specially provided for in the specifications.

### **38. Deleted**

- 39. (1) Rates for extra items of works:-** Any type of work carried out by the Contractor on the instructions of the Engineer which is not included in the accepted schedules of rates shall be executed at the rates set forth in the "Schedule of Prices of Railway" modified by the tender percentage and such items that are not contained in the later, at the rate agreed upon between the Engineer and the Contractor before the execution of such items of work and the Contractors shall be bound to notify the Engineer at least seven days before the necessity arises for the execution of such items of works that the accepted schedule of rates does not include rate or rates for the extra work involved. The rates payable for such items shall be decided at the meeting to be held between the Engineer and Contractor, in as short a period as possible after the need for the special item has come to the notice. In case the Contractor fails to attend the meeting after being notified to do so or in the event of no settlement being arrived at, the Railway shall be entitled to execute the extra works by other means and the Contractor shall have no claim for loss or damage that may result from such procedure.
- (2)** Provided that if the Contractor commences work or incurs any expenditure in regard thereto before the rates as determined and agreed upon as lastly hereunto fore mentioned, then and in such a case the Contractor shall only be entitled to be paid in respect of the work carried out or the rates as shall be fixed by the Engineer. However if the Contractor is not satisfied with the decision of the Engineer in this respect he may appeal to the Chief Engineer within 30 days of getting the decision of the Engineer, supported by analysis of the rates claimed. The Chief Engineer's decision after hearing both the parties in the matter would be final and binding on the Contractor and the Railway.

**40. (1) Handing over of works:-** The Contractor shall be bound to hand over the works executed under the contract to the Railway complete in all respects to the satisfaction of the Engineer. The Engineer shall determine the date on which the work is considered to have been completed, in support of which his certificate shall be regarded as sufficient evidence for all purposes. The Engineer shall determine from time to time, the date on which any particular section of the work shall have been completed, and the contractor shall be bound to observe any such determination of the Engineer.

**(2) Clearance of site on completion:-** On completion of works, the Contractor shall clear away and remove from the site all constructional plant, surplus materials, rubbish and temporary works of every kind and leave the whole of the site and works clean and in a workman like condition to the satisfaction of the Engineer. No final payment in settlement of the accounts for the works shall be paid, held to be due or shall be made to the, Contractor till, in addition to any other condition necessary for final payment, site clearance shall have been affected by him, and such clearance may be made by the Engineer at the expense of the Contractor in the event of his failure to comply with this provision within 7 days after receiving notice to that effect. Should it become necessary for the Engineer to have the site cleared at the expenses of the Contractor, the Railway shall not be held liable for any loss or damage to such of the Contractor's property as may be on the site and due to such removal there from which removal may be effected by means of public sales of such materials and property or in such a way as deemed fit and convenient to the Engineer.

### **VARIATIONS IN EXTENT OF CONTRACT**

**41. Modification to contract to be in writing:-** In the event of any of the provisions of the contract requiring to be modified after the contract documents have been signed, the modifications shall be made in writing and signed by the Railway and the Contractor and no work shall proceed under such modifications until this has been done. Any verbal or written arrangement abandoning, modifying, extending, reducing or supplementing the contract or any of the terms thereof shall be deemed conditional and shall not be binding on the Railway unless and until the same is incorporated in a formal instrument and signed by the Railway and the Contractor, and till then the Railway shall have the right to repudiate such arrangements.

**42. (1) Powers of modification to contract:-** The Engineer on behalf of the Railway shall be entitled by order in writing to enlarge or extend, diminish or reduce the works or make any alterations in their design, character position, site, quantities, dimensions or in the method of their execution or in the combination and use of materials for the execution thereof or to order any additional work to be done or any works not to be done and the contractor will not be entitled, to any compensation for any increase/reduction in the quantities of work but will be paid only for the actual amount of work done and for approved materials supplied against a specific order.

(2) (i) Unless otherwise specified in the special conditions of the contract, the accepted variation in quantity of each individual item of the contract would be up to 25% of the quantity originally contracted, except in case of foundation work. The contractor shall be bound to carry out the work at the agreed rates and shall not be entitled to any claim or any compensation whatsoever up to the limit of 25% variation in quantity of individual item of works.

(ii) In case of earthwork, the variation limit of 25% shall apply to the gross quantity of earth work and variation in the quantities of individual classifications of soil shall not be subject to this limit.

(iii) In case of foundation work, no variation limit shall apply and the work shall be carried out by the contractor on agreed rated irrespective of any variation.

(3) **Valuation of variations:-** the enlargements, extensions, diminution, reduction, alterations or additions referred to in sub-clause (2) of this clause shall in no degree affect the validity of the contract but shall be performed by the Contractor as provided therein and be subject to the same conditions, stipulations and obligations as if they had been originally and expressly included and provided for in the specifications and drawings and the amounts to be paid therefore shall be calculated in accordance with the accepted schedule of rates. Any extra items/quantities of work falling outside the purview of the provisions of sub-clause (2) above shall be paid for at the rates determined under clause-39 of these conditions.

### CLAIMS

**43. (1) Monthly Statement of Claims:-** The Contractor shall prepare and furnish to the Engineer once in every month an account giving full and detailed particulars of all claims for any additional expenses to which the Contractor may consider himself entitled to and of all extra or additional works ordered by the Engineer which he has executed during the preceding month and no claim for payment for and such work will be considered which has not been included in such particulars.

**(2) Signing of “No Claim” Certificate:-** The Contractor shall not be entitled to make any claim whatsoever against the Railway/DFCCIL under or by virtue of or arising out of this contract, nor shall the Railway entertain or consider any such claim, if made by the Contractor, after he shall have signed a “No Claim” Certificate in favour of the Railway/DFCCIL in such form as shall be required by



the Railway/DFCCIL after the works are finally measured up. The contractor shall be debarred from disputing the correctness of the items covered by "No Claim" Certificate or demanding a clearance to arbitration in respect thereof.

### **MEASUREMENTS, CERTIFICATES AND PAYMENTS**

- 44. Quantities in schedule annexed to Contract:-** The quantities set out in the accepted schedule of rates with items of works quantified are the estimated quantities of the works and they shall not be taken as the actual and correct quantities of the work to be executed by the Contractor in fulfillment of his obligations under the contract.
- 45. Measurement of works:-** The Contractor shall be paid for the works at the rates in the accepted schedule of rates and for extra works at rates determined under Clause 39 of these conditions on the measurements taken by the Engineer or the Engineer's representative in accordance with the rules prescribed for the purpose by the Railway. The quantities for items the unit of which in the accepted schedule of rates is 100 or 1000 shall be calculated to the nearest whole number, any; fraction below half being dropped and half and above being taken as one; for items the unit of which in the accepted schedule of rates is single, the quantities shall be calculated to two places of decimals. Such measurements will be taken of the work in progress from time to time and at such intervals as in the opinion of the Engineer shall be proper having regard to the progress of works. The date and time on which "on account" or final measurements are to be made shall be communicated to the Contractor who shall be present at the site and shall sign the results of the measurements (which shall also be signed by the Engineer or the Engineer's representative) recorded in the official measurements book as an acknowledgement of his acceptance of the accuracy of the measures. Failing the Contractor's attendance the work may be measured up in his absence and such measurements shall, notwithstanding such absence, be binding upon the Contractor whether or not he shall have signed the measurement books provided always that any objection made by him to measurement shall be duly investigated and considered in the manner set out below:-
- (a) It shall be open to the Contractor to take specific objection to any recorded measurements or Classification on any ground within seven days of the date of such measurements. Any re measurement taken by the engineer or the Engineer's representative in the presence of the Contractor or in his absence after due notice has been given to him in consequence of objection made by the Contractor shall be final and binding on the Contractor and no claim whatsoever shall thereafter be entertained regarding the accuracy and classification of the measurements.

- (b) If an objection raised by the Contractor is found by the Engineer to be incorrect the Contractor shall be liable to pay the actual expenses incurred in measurements.

**46.(1) “On-Account” Payments:-** The Contractor shall be entitled to be paid from time to time by way of “One-Account” payment only for such works as in the opinion of the Engineer he has executed in terms of the contract. All payments due on the Engineer’s or the Engineer’s Representative’s certificates of measurements shall be subject to any deductions which may be made under these presents and shall further be subject to, unless otherwise required by Clause 16 of these conditions, a retention of ten percent by way of security deposits, until the amount of security deposit by way of retained earnest money and such retentions shall amount to 10% of the total value of the contract provided always that the Engineer may by any certificate make any correction or modification in any previous certificate which shall have been issued by him and that the Engineer may withhold any certificate if the works or any part thereof are not being carried out to his satisfaction.

(2) **Rounding off amounts:** - The total amount due on each certificate shall be rounded off to the nearest rupee i.e. sum less than 50 paise shall be omitted and sums of 50 paise and more upto Re. 1/- will be reckoned as Re. 1/-

(3) **On Account Payments not prejudicial to final settlement:** - “On-Account” payments made to the Contractor shall be without prejudice to the final making up of the accounts (except where measurements are specifically noted in the Measurement Book as “Final Measurements” and as such have been signed by the Contractor) and shall in no respect be considered or used as evidence of any facts stated in or to be inferred from such accounts nor of any particular quantity of work having been executed nor of the manner of its execution being satisfactory.

(4) **Manner of payment:** - Unless otherwise specified payments to the Contractor will be made by cheque but no cheque will be issued for an amount less than Rs. 100/-

#### **46A. Price Variation Clause (PVC):**

Price variation shall be governed by clause 1.3.2 (c) of **Part-I, chapter III, Price & Payment**

**47. Maintenance of works:-** The Contractor shall at all times during the progress and continuance of the works and also for the period of maintenance specified in the Tender Form after the date of passing of the certificate of completion by the Engineer or any other earlier date subsequent to the completion of the works that may be fixed by the Engineer be responsible for and effectively maintain and

uphold in good substantial, sound and perfect condition all and every part of the works and shall make good from time to time and at all times as often as the Engineer shall require, any damage or defect that may during the above period arise in or be discovered or be in any way connected with the works, provided that such damage or defect is not directly caused by errors in the contract documents, act of providence or insurrection or civil riot, and the contractor shall be liable for and shall pay and make good to the Railway or other persons legally entitled thereto whenever required by the Engineer so to do, all losses, damages, costs and expenses they or any of them may incur or be put or be liable to by reasons or in consequence of the operations of the Contractor or of his failure in any respect.

- 48.(1) Certificate of completion of works:** - As soon as in the opinion of the Engineer, the works has been completed and has satisfactorily passed any final test or tests that may be prescribed, the Engineer shall issue a certificate of completion duly indicating the date of completion in respect, of the work and the period of maintenance of the work shall commence from the date of completion mentioned in such certificate. The Engineer may also issue such a certificate indicating date of completion with respect to any part of the work (before the completion of the whole of work), which has been both completed to the satisfaction of the Engineer and occupied or used by the Railway. When any such certificate is given in respect of part of a work, such part shall be considered as completed and the period of maintenance of such part shall commence from the date of completion mentioned in the completion certificate issued for that part of the work.
- (2) Contractor not absolved by completion Certificate:** - The Certificate of completion in respect of the works referred to in sub-clause (1) of this clause shall not absolve the Contractor from his liability to make good any defects imperfections, shrinkages or faults which may appear during the period of maintenance specified in the tender arising in the opinion of the Engineer from materials or workmanship not in accordance with the drawings or specifications or instruction of the Engineer, which defects, imperfections, shrinkages or faults shall upon the direction in writing of the Engineer be amended and made good by the Contractor at his own cost: and in case of default on the part of Contractor the Engineer may employ labour and materials or appoint another Contractor to amend and make good such defects, imperfections, shrinkages and faults and all expenses consequent thereon and incidental thereto shall be borne by the Contractor and shall be recoverable from any moneys due to him under the contract.
- 49. Approval only by maintenance Certificate:** - No certificate other than maintenance certificate referred to in Clause 50 of the conditions shall be deemed to constitute approval of any work or other matter in respect of which it is issued or shall be taken as an admission of the due performance of the contract

or any part thereof or of the accuracy of any claim or demand made by the Contractor or of additional varied work having been ordered by the Engineer not shall any other certificate conclude or prejudice any of the powers of the Engineer.

**50.(1) Maintenance Certificate:-** The Certificate shall not be considered as completed until a maintenance Certificate shall have been signed by the Engineer stating that the works have been completed and maintained to his satisfaction. The maintenance Certificate shall be given by the Engineer upon the expiration of the period of maintenance or as soon thereafter as any works ordered during such period pursuant to sub clause (2) Clause 48 of these conditions shall have been completed to the satisfaction of the Engineer and full effect shall be given to this Clause notwithstanding the taking possession of a or using the works or any part thereof by the Railway.

**(2) Cessation of Railway's Liability:** - The Railway shall not be liable to the Contractor for any matter arising out of or in connection with the contract of the execution of the works unless the contractor shall have made a claim in writing in respect thereof before the issue of the Maintenance Certificate under this clause.

**(3) Unfulfilled Obligations:** - Notwithstanding the issue of the Maintenance certificate the Contractor and (subject to sub-clause2of this clause) the Railway shall remain liable for the fulfillment of any obligation incurred under the provision of the contract prior to the issue of the maintenance Certificate which remains unperformed at the time such certificate is issued and for the purposes of determining the nature and extent of any such obligations the contract shall be deemed to remain in force between the parties thereto.

**51. (1) Final Payment:-** On the Engineer's certificate of completion in respect of the works adjustment shall be made and the balance of account based on the Engineer or the Engineer's representative's certified measurements of the total quantity of work executed by the contractor upto the date of completion and on the accepted schedule or rates and for extra works on rates determined under Clause 39 of these conditions shall be paid to the Contractor subject always to any deduction which may be made under these presents and further subject to the Contactor having delivered to the Engineer either a full account in detail of all claims he may have on the Railway in respect of the works or having delivered "No Claim" Certificate and the Engineer having after the receipt of such account given a certificate in writing that such claims are correct, that the whole of the works to be done under the provisions of the Contracts have been completed, that they have been inspected by him since their completion and found to be in good and substantial order, that all properties, works and things, removed, disturbed or injured in consequence of the woks have been properly replaced and made good and all expenses and demands incurred by or made upon the

Railway for or in the respect of damage or loss by from or in consequence of the works, have been satisfied agreeably and in conformity with the contract.

- (2) Post Payment Audit:-** It is an agreed term of contract that the Railway reserves to itself the right to carry out a post-payment audit and or technical examination of the works and the final bill including all supporting vouchers, abstracts, etc., and to make a claim on the contractor for the refund any excess amount paid to him if as a result of such examination any over-payment to him is discovered to have made in respect of any works done or alleged to have been done by him under the contract.

**51-A. Production of vouchers etc. by the Contractor:-**

(i) For a contract of more than one crore of rupees, the contractor shall, whenever required, produce or cause to be produced for examination by the Engineer any quotation, invoice, cost or other account, book of accounts, voucher, receipt, letter, memorandum, paper of writing or any copy of or extract from any such document and also furnish information and returns verified in such manner as may be required in any way relating to the execution of this contract or relevant for verifying or ascertaining cost of execution of this contract (the decision of the engineer on the question of relevancy of any documents, information or return being final and binding in the parties). The contractor shall similarly produce vouchers; etc., if required to prove to the Engineer, that materials supplied by him, are in accordance with the specifications laid down in the contract.

(ii) If any portion of the work in a contract of value more than one crore of rupees be carried out by a sub-contractor or any subsidiary or allied firm or company (as per Clause 7 of the General Conditions of Contract), the Engineer shall have power to secure the books of such sub-contract or any subsidiary or allied firm or company, through the contractor, and such books shall be open to his inspection.

(iii) The obligations imposed by sub clause (i) & (ii) above is without prejudice to the obligations of the contractor under any statute rules or orders binding on the contractor.

- 52. Withholding and lien in respect of sums claimed:-** Whenever any claim or claims for payment of a sum of money arises out of or under the contract against the contractor, the Railway shall be entitled to withhold and also have a lien to retain such sum or sums in whole or in part from the security, if any, deposited by the contractor and for the purpose aforesaid, the Railway shall be entitled to withhold the said cash security deposit or the security if any, furnished as the case may be and also have a lien over the same pending finalization or adjudication of any such claim. In the event of the security being insufficient to cover the claimed

amount or amounts or if no security has been taken from the contractor, the Railway shall be entitled to withhold and have a lien to the extent of the such claimed amount or amounts referred to supra, from any sum or sums found payable or which at any time thereafter may become payable to the contractor under the same contract or any other contract with this or any other Railway or any Department of the Central Government pending finalization or adjudication of any such claim.

It is an agreed term of the contract that the sum of money or moneys so withheld or retained under the lien referred to above, by the Railway will be kept withheld or retained as such by the Railways till the claim arising out of or under the contract is determined by the arbitrator (if the contract governed by the arbitration clause) or by the competent court as the case may be and that the contractor will have no claim for interest or damages whatsoever on any account in respect of such withholding or retention under the lien referred to supra and duly notified as such to the contractor. For the purpose of this clause, where the contractor is a partnership firm or a limited company, the Railway shall be entitled to withhold and also have a lien to retain towards such claimed amount or amounts in whole or in part from any sum found payable to any partner/limited company, as the case may be whether in his individual capacity or otherwise.

**52-A Lien in respect of claims in Other Contracts:-** Any sum of money due and payable to the contractor (including the security deposit returnable to him) under the contract may be withheld or retained by way of lien by the Railway, against any claim of this or any other Railway or any other Department of the Central Government in respect of a payment of a sum of money arising out of or under any other contract made by the contractor with this or any other Department of the Central Government.

It is an agreed term of the contract that the sum of money so withheld or retained under this clause by the Railway will be kept withheld or retained as such by the Railway till the claim arising out of or under any other contract is either mutually settled or determined by arbitration, if the other contract is governed by arbitration clause or by the competent court as the case may be and contractor shall have no claim for interest or damages whatsoever on this account or on any other ground in respect of any sum of money withheld or retained under this clause and duly notified as such to the contractor.

**53. Signature on Receipts for Amounts:-** Every receipt for money which may become payable or for any security which may become transferable to the Contractors under these presents, shall, if signed in the partnership name by anyone of the partners of a Contractor's firm be a good and sufficient discharge to the Railway in respect of the moneys or security purported to be acknowledged thereby and in the event of death of any of the Contractor, partners during the pendency of the contract it is hereby expressly agreed that every receipt by

anyone of the surviving Contractor partners shall if so signed as aforesaid be good a sufficient discharge as aforesaid provided that nothing in this clause contained shall be deemed to prejudice or effect any claim which the Railway may hereafter have against the legal representative of any contractor partner so dying for or in respect to any breach of any of the conditions of the contract, provided also that nothing in this clause contained shall be deemed to prejudice or effect the respective rights or obligations of the Contractor partners and of the legal representatives of any deceased Contractor partners interse.

## LABOUR

- 54. Wages to Labour:-** The Contractor shall be responsible to ensure compliance with the provision of the Minimum Wages Act, 1948 (hereinafter referred to as the "said Act" and the Rules made there under in respect of any employees directly or through petty contractors or subcontractors employed by him on road construction or in building operations or in stone breaking or stone crushing for the purpose of carrying out this contract.

If, in compliance with the terms of the contract, the Contractor supplied any labour to be used wholly or partly under the direct orders and control of the Railway whether in connection with any work being executed by the Contractor or otherwise for the purpose of the Railway such labour shall, for the purpose of this clause, still be deemed to be persons employed by the Contractor.

If any moneys shall, as a result of any claim or application made under the said Act be directed to be paid by the Railway, such money shall be deemed to be moneys paid by it as aforesaid within seven days after the same shall have been demanded, the Railways shall be entitled to recover the same form any moneys due or accruing to the Contractor under this or any other Contract with the Railways.

- 54-A. Apprentices Act:-** The Contractor shall be responsible to ensure compliance with the provisions of the Apprentices Act, 1961 and the Rules and Orders issued there under from time to time in respect of apprentices directly or through petty contractors or sub-contractors employed by him for the purpose of carrying out the Contract.

If the contractor directly or through petty contractors or sub-contractors fails to do so, his failure will be a breach of the contract and the Railway may, in its discretion, rescind the contract. The contractor shall also be liable for any pecuniary liability arising on account of any violation of the provisions of the Act.

**Note:** The contractors are required to engage apprentices when the works undertaken by them last for a period of one year or more and/the cost of works is rupees on lakh or more.

**55. Provisions of payments of Wages Act:-** The Contractor shall comply with the provisions of the Payment of Wages Act, 1936 and the rules made there under in respect of all employees directly or through petty contractors or sub-contractors employed by him in the works. If In compliance with the terms of the contract, the Contractor directly or through petty contractors of sub-contractors shall supply and layout to be used wholly or partly under the direct orders and control of the Engineer whether in connection with the works to the executed hereunder or otherwise for the purpose of the Engineer such labour shall never the less be deemed to comprise persons employed by the contractor and any moneys which may be ordered to be paid by the Engineer shall be deemed to be moneys payable by the Engineer on behalf of the Contractor and the Engineer may due to the Contractor in terms of the contract. The Railway shall be entitled to deduct from any moneys due to the contractor (whether under this contract or any other contract) all moneys paid or payable by the Railway by the way of compensation of aforesaid or for costs of expenses in connection with any claim thereto and the decision of the Engineer upon any question arising out of the effect or force of this clause shall be final and binding upon the Contractor.

**55-A (1) Provisions of Contract labour (Regulation and Abolition) Act, 1970 –**

- (1) The contractor shall comply with the provision of the contract labour (Regulation and Abolition) Act, 1970 and the Contract labour (Regulation and Abolition) Central Rules 1971 as modified from time to time, wherever applicable and shall also indemnify the Railway from and against any claims under the aforesaid Act and the Rules.
- (2) The Contractor shall obtain a valid licence under the aforesaid Act as modified from time to time before the commencement of the work and continue to have a valid licence until the completion of the work. Any failure to fulfill the requirement shall attract the penal provision of the Contract arising out of the resultant non-execution of the work.
- (3) The Contractor shall pay to the labour employed by him directly or through subcontractors the wages as per provision of the aforesaid Act and the Rules wherever applicable. The Contractor shall notwithstanding the provisions of the contract to the contrary, cause to be paid the wages to labour indirectly engaged on the works including any engaged by subcontractors in connection with the said work, as if the labour had been immediately employed by him.
- (4) In respect of all labour directly or indirectly employed in the work for performance of the contractor's part of, the contract, the Contractor shall comply with or cause to be complied with the provisions of the aforesaid Act and Rules wherever applicable.



(5) In every case in which, by virtue of the provisions of the aforesaid Act or the Rules, the Railway is obliged to pay any amount of wages to a workman employed by the Contractor or his sub contractor in execution of the work or no incur any expenditure on account of the Contingent, liability of the Railway due to the contractor's failure to fulfill his statutory obligations under the aforesaid Act or the rules the Railway will recover from the Contractor, the amount of wages so paid or the amount of expenditure so incurred, and without prejudice to the rights of the Railway under the section 20, sub-section (2) and section 2, sub-section (4) of the aforesaid Act, the Railway shall be at liberty to recover such amount or part thereof by deducting it from the security deposit and/ or from any sum due by the Railway to the contractor whether under the contract or otherwise. The Railway shall not be bound to contest any claim made against it under sub-section (1) of section 20 and sub-section (4) of section 21 of the aforesaid Act except on the written request of the contractor and upon his giving to the Railway full security for all costs for which the Railway might become liable in contesting such claim. The decision of the Railway regarding the amount actually recoverable from the contractor as stated above shall be final and binding on the Contractor.

**55-B. Provisions of Employees Provident Fund and Miscellaneous Provisions Act, 1952:**

The Contractor shall comply with the provisions of Para 30 & 36-B of the Employees Provident Fund Scheme, 1952; Para 3 & 4 of Employees' Pension Scheme, 1995; and Para 7 & 8 of Employees Deposit Linked Insurance Scheme, 1976; as modified from time to time through enactment of "Employees Provident Fund & Miscellaneous Provisions Act, 1952", wherever applicable and shall also indemnify the Railway from and against any claims under the aforesaid Act and the Rules.

{Authority: Railway Board's letter no. 2012/CE-I/CT/O/22, dated 14.12.2012}

**55-C. Implementation of "the building and other construction worker's (Regulation of Employment and condition of service) Act, 1996" and "The building and other construction worker's welfare Cess Act, 1996."**

The tenderers for carrying out any construction work must get themselves registered from the Registering officer under section-7 of the "Building and construction worker's Act, 1996." And rules made there to by the concern state government and submit certificates of registration issued from the registering officer of the concern state government (Labour Dept.). as per this act, the tenderer shall be levied a Cess @ 1% of cost of construction work, which would be deducted from each bill. Cost of material, when supplied under separate schedule item, shall be outside the purview of Cess.

{Authority : Railway Board's letter no. 2008/CE-I/CT/O/6, dated 29.11.2013}

- 56. Reporting of Accidents of Labour:-** The Contractor shall be responsible for the safety of all employees directly or through petty contractors or sub-contractor employed by him on the works and shall report serious accidents to any of them however and wherever occurring on the works to the Engineer or the Engineers Representative and shall made every arrangements to render all possible assistance.
- 57. Provision of Workmen's Compensation Act:-** In every case in which by virtue of the provisions of section 12 sub-section (1) of the Workmen's Compensation Act 1923, Railway is obliged to pay compensation to a workman directly or through petty contractor or subcontractor employed by the Contractor in executing the work, Railway will recover from the Contractor the amount of the compensation so paid, and, without prejudice to the rights of Railway under Section 12 Sub-section (2) of the said Act, Railway shall be at liberty to recover such amount or any part thereof by deducting it from the security deposit or from any sum due by Railway to the Contractor whether under these conditions or otherwise, Railway shall not be bound to contest any claim made against it under Section 12 Sun-section (1) of the said Act except on the written request of the Contractor and upon his giving to Railway full security for all costs for which Railway might become liable in consequence of contesting such claim.
- 57-A Provision of Mines Act:-** The contractor shall observe and perform all the provisions of the Mines Act, 1952 or any statutory modifications or re-enactment thereof for the time being in force and any rules and regulations made there under in respect of all the persons directly or through the petty contractors or sub-contractors employed by him under this contract and shall indemnify the Railway from and against any claims under the Mines Act, or the rules and regulations framed there under, by or on behalf of any persons employed by him or otherwise.
- 58 Railway not to provide quarters for Contractors:-**No quarters shall normally be provided by the Railway for the accommodation of the contractor or any of his staff employed on the work.
- 59(1) Labour Camps:-**The contractor shall at his own expense make adequate arrangements for the housing, supply of drinking water and provision of latrines and urinals for his staff and workmen, directly or through the petty contractors or sub-contractors and for temporary crèche (Bal-mandir) where 50 or more women are employed at a time. Suitable sites on Railway land, if available, may be allotted to the contractor for the erection of labour camps, either free of charge or on such terms and conditions that may be prescribed by the Railway. All camp sites shall be maintained in clean and sanitary conditions by the contractor at his own cost.

- (2) **Compliance to rules for employment of labour:-** The contractor(s) shall conform to all laws, by-laws rules and regulations for the time being in force pertaining to the employment of local or imported labour and shall take all necessary precautions to ensure and preserve the health and safety of all staff employed directly or through petty contractors or sub-contractors on the works.
- (3) **Preservation of peace:-** The contractor shall take requisite precautions and use his best endeavours to prevent any riotous or unlawful behaviour by or amongst his workmen and other employed directly or through the petty contractors or sub-contractors on the works and for the preservation of peace and protection of the inhabitants and security of property in the neighbourhood of the works. In the event of the Railway requiring the maintenance of a special Police Force at or in the vicinity of the site during the tenure of works, the expenses thereof shall be borne by the contractor and if paid by the Railway shall be recoverable from the contractor.
- (4) **Sanitary arrangements:-** The contractor shall obey all sanitary rules and carry out all sanitary measures that may from time to time be prescribed by the Railway Medical Authority and permit inspection of all sanitary arrangements at all times by the Engineer, the Engineer's Representative of the Medical staff of the Railway. Should the contractor fail to make the adequate sanitary arrangements, these will be provided by the Railway and the cost therefore recovered from the contractor.
- (5) **Outbreak of infectious disease:-** The contractor shall remove from his camp such labour and their families as refuse protective inoculation and vaccination when called upon to do so by the Engineer or the Engineer's representative on the advice of the Railway Medical Authority. Should cholera, plague or other infectious disease break out, the contractor shall burn the butts, beddings, clothes and other belongings of or used by the infected parties and promptly erect new huts on health sites as required by the engineer, failing which within the time specified in the Engineer's requisition, the work may be done by the Railway and the cost therefore recovered from the contractor.
- (6) **Deleted**
- (7) **Medical facilities at site: -** The Contractor shall provide medical facilities at the site as may be prescribed by the Engineer on the advice of the Railway Medical Authority in relation to the strength of the Contractor's resident staff and workmen.
- (8) **Use of intoxicants: -** The sale of ardent spirits or other intoxicating beverages upon the work or in any of the buildings, encampments or tenements owned, occupied by or within the control of the contractor or any of his employees shall

be forbidden and the Contractor shall exercise his influence and authority to the utmost extent to secure strict compliance with this condition.

- (9) **Non-employment of female labour:** - The Contactor shall see that the employment of female labour on in Cantonment areas, particularly in the neighbourhood of soldier's barracks, should be avoided as far as possible.
- (10) **Restrictions on the employment of retired Engineers of Railway services within two years of their retirement:-** The Contractor shall not, if he is a retired Government Engineer of Gazetted rank, who has not completed two years from the date of retirement, in connection with this contract in any manner whatsoever without obtaining prior permission of the President and if the Contractor is found to have contravened this provision it will constitute a breach of contract and administration will be entitled to terminate the contract at the risk and cost of the contractor and forfeit his security deposit.
60. (1) **Non-employment of labours below the age of 15:-** the Contractor shall not employ children below the age of 15 as labourers directly or through petty contractors or subcontractors for the execution of work.
- (2) **Medical Certificate of fitness for labour:** - It is agreed that the contractor shall not employ a person above 15 and below 19 years of age for the purpose of execution of work under the contract unless a medical certificate of fitness in the prescribed form granted to him by a certifying surgeon certifying that he is fit to work as an adult is obtained and kept in the custody of the contractor or a person nominated by him in this behalf and the person carries with him, while at work; a token giving a reference to such certificate. It is further agreed that the responsibility for having the adolescent examined medically at the time of appointment or periodically till he attains the age of 19 years shall devolve entirely on the contractor and all the expenses to be incurred on this account shall be borne by him an no fee shall be charged from the adolescent or his parent for such medical examination.
- (3) **Period of validity of medical fitness certificate:** - A certificate of fitness granted or renewed for the above said purposes shall be valid only for a period of one year at a time. The certifying surgeon shall revoke a certificate granted or renewed if in his opinion the holder or it is, not longer fit for work in the capacity stated therein. Where a certifying surgeon refuses to grant or renew a certificate or revoke a certificate, he shall, if so required by the person concerned, state his reasons in writing for doing so.
- (4) **Medical re-examination of labourer:-** Where any official appointed in this behalf by the Ministry of labour is of the opinion that any person employed in connection with the execution of any work under this contract in the age group 15 to 19 years is without a certificate of fitness or is having a certificate of fitness but no longer fit to work in the capacity stated in the certificate, he may serve on the

Contractor, or on the person nominated by him in the regard, a notice requiring that such persons shall be examined by a certifying surgeon and such person shall not if the concerned official so directs, be employed or permitted to do any work under this contract unless he has been medically examined and certified that he has been granted a certificate of fitness or a fresh certificate of fitness, as the case may be.

**EXPLANATIONS:-**

- (1) only qualified medical practitioners can be appointed as “Certifying Surgeons” and the term “Qualified Medical Practitioners” means a person holding a qualification granted by an authority specified in the Schedule to the Indian Medical Degrees Act, 1916 (VII to 1916) or in the Schedule to the Indian Medical Council Act, 1933 (XXVII) of 1933.
- (2) The Certifying surgeon may be a medical officer in the service of State or Municipal Corporation.

**DETERMINATION OF CONTRACT**

**61. (1) Right of Railway of determine the contract:** - The Railway shall be entitled to determine and terminate the contract at any time should, in the Railway’s opinion, the cessation of work becomes necessary owing to paucity of funds or from any other cause whatever, in which case the value of approved materials at site and of work done to date by the Contractor will be paid for in full at the rate specified in the contract. Notice in writing from the Railway of such determination and the reasons therefore shall be conclusive evidence thereof.

**(2) Payment on determination of contract:** - Should the contract be determined under sub clause (1) of this clause and the Contractor claims payment for expenditure incurred by him in the expectation of completing the whole of the work, the Railways shall admit and consider such claims as are deemed reasonable and are supported by vouchers to the satisfaction of the Engineer. The Railway’s decision on the necessity and propriety of such expenditure shall be final and conclusive.

**(3)** the contractor shall have no claim to any payment of compensation or otherwise, howsoever on account of any profit or advantage which he might have derived from the execution of the work in full but which he did not derive in consequence of determination of contract.

**62 (1) Determination of contract owing to default of contractor:-** If the Contractor should:-

- (i) Becomes bankrupt or insolvent, or

- (ii) Make an arrangement with of assignment in favour of his creditors, or agree to carry out the contract under a Committee of Inspection of his creditors, or
- (iii) Being a Company or Corporation, go into liquidation (other than a voluntary liquidation for the purposes of amalgamation or reconstruction), or
- (iv) Have an execution levied on his goods or property on the works, or
- (v) Assign the contract or any part thereof otherwise than as provided in clause 7 of these conditions, or
- (vi) Abandon the contract, or
- (vii) Persistently disregard the instructions of the Engineer, or contravene any provision of the contract, or
- (viii) Fail to adhere to the agreed programme of work by a margin of 10% of the stipulated period, or
- (ix) Fail to remove materials from the site or to pull down and replace work after receiving from the Engineer notice to the effect that the said materials or works have been condemned or rejected under clause 25 and 27 of these conditions, or
- (x) fail to take steps to employ competent or additional staff and labour as required under clause 26 of the conditions
- (xi) fail to afford the Engineer or Engineer's representative proper facilities for inspecting the work or any part thereof as required under clause 28 of the conditions, or
- (xii) promise, offer or give any bribe, commission, gift or advantage either himself or through his partner, agent or servant to any officer or employee of the Railway or to any person on his or on their behalf in relation to the execution of this or any other contract with this Railway.
- (xiii) **(A)** At any time after the tender relating to the contract, has been signed and submitted by the Contractor, being a partnership firm admit as one of its partners or employ under it or being an incorporated company elect or nominate or allow to act as one of its directors or employ under it in any capacity whatsoever any retired engineer of the gazette rank or any other retired gazette officer working before his retirement, whether in the executive or administrative capacity, or whether holding any pensionable post or not, in any Department of the Railways for the time being owned and administered by the President of India before the expiry of two years from the date of retirement from the said

service of such Engineer or Officer unless such Engineer or Officer has obtained permission from the President of India or any officer duly authorized by him in this behalf to become a partner or a director or to take employment under the contract as the case may be, or

**(B) Fail to give at the time of submitting the said tender:-**

- (a) The correct information as to the date of retirement of such retired engineer or retired officer from the said service, or as to whether any such retired engineer or retired officer was under the employment of the Contractor at the time of submitting the said tender, or
- (b) The correct information as to such engineers or officers obtaining permission to take employment under the contractor, or
- (c) Being a partnership firm, the correct information as to, whether any of its partners was such a retired engineer or a retired officer, or
- (d) Being in incorporated company, correct information as to whether any of its directors was such a retired engineer or a retired officer, or
- (e) Being such a retired engineer or retired officer suppress and not disclose at the time of submitting the said tender the fact of his being such a retired engineer or a retired officer or make at the time of submitting the said tender a wrong statement in relation to his obtaining permission to take the contract or if the contractor be a partnership firm or an incorporated company to be a partner or director of such firm or company as the case may be or to seek employment under the contractor, and or company as the case may be or to seek employment under the contractor, and after expiry of 48 hours notice a final termination notice should be issued.

Then and in any of the said clause, the Engineer on behalf of the Railway may serve the Contractor with a notice in writing to that effect and if the contractor does not within seven days after the delivery to him of such notice proceed to make good his default in so far as the same is capable of being made good and carry on the work or comply with such directions as aforesaid of the entire satisfaction of the Engineer, the Railway shall be entitled after giving 48 hours notice in writing under the hand of the Engineer to rescind the contract as a whole or in part or parts (as may be specified in such notice) and after expiry of 48 hours notice, a final termination notice should be issued and adopt the following courses:

To measure up or the whole or part of the work from which the contractor has been removed and get it completed by another contractor, the manner and

method in which such work is completed shall be in the entire discretion of the Engineer whose decision shall be final.

**62 (2) Right of Railway after, rescission of contract owing to default of contractor:**

In the event of any or several of the courses, referred to in sub-clause (1) of the clause, being adopted.

- (a) The contractor shall have no claim to compensation for any loss sustained by him by reason of his having purchased or procured any materials or entered into any commitments or made any advances on account of or with a view to the execution of the works or the performance of the contract and contractor shall not be entitled to recover or be paid any sum for any work thereto for actually performed under the contract unless and until the Engineer shall have certified the performance of such work and the value payable in respect thereof and the contractor shall only be entitled to be paid the value so certified.
- (b) The Engineer or the Engineer's representative shall be entitled to take possession of any materials, tools, implements, machinery and buildings on the works or on the property on which these are being or ought to have been executed, and to retain and employ the same in the further execution of the works or any part thereof until the completion of the works without the contractor being entitled to any compensation for the use and employment thereof or for wear and tear or destruction thereof.
- (c) The Engineer shall as soon as may be practicable after removal of the contractor fix and determine ex-parte or by or after reference to the parties or after such investigation or enquiries as he may consider fit to make or institute and shall certify what amount(if any) had at the time of rescission of the contract been reasonably earned by or would reasonably accrue to the contractor in respect of the work then actually done by him under the contract and what was the value of any unused, or partially used materials, any constructional plan and any temporary works upon the site. The legitimate amount due to the contractor after making necessary deductions and certified by the Engineer should be released expeditiously.

**STATEMENT OF DISPUTES – INDIAN RAILWAY ARBITRATION RULES**

- 63. Matters finally determined by the Railway –** All disputes and differences of any kind whatsoever arising out of or in connection with the contract, whether during the progress of the work or after its completion and whether before or after the determination of the contract, shall be referred by the contractor to the General Manager and the General Manager shall within 120 days after receipt of the contractor's representation make and notify decisions on all matters referred to by the contractor in writing provided that matter for which provision has been made in clauses 8, 18, 22(5), 39, 43(2), 45(a),55,55-A(5), 57, 57A, 61(1), 61(2)



and 62(1) to (xiii) (B) of General Conditions of contract or in any special clause of the conditions of the contract shall be deemed as 'excepted matters' (matters not arbitrable) and decisions of the Railway authority, thereon shall be final and binding on the contractor; provided further that 'excepted matters' shall stand specifically excluded from the purview of the arbitration clause.

#### **64 Demand for Arbitration**

##### **64(1)**

- (i) Demand for Arbitration:-**In the event of any dispute or difference between the parties hereto as to the construction or operation of this contract, or the respective rights and liabilities of the parties on any matter in question, dispute or difference on any account or as to the withholding by the Railway of any certificate to which the contractor may claim to be entitled to, or if the Railway fails to make a decision within 120 days, then and in any such case, but except in any of the 'excepted matters' referred to in clause 63 of these conditions, the contractor, after 120 days but within 180 days of his presenting his final claim on disputed matters shall demand in writing that the dispute or difference be referred to arbitration.
- (ii)** The demand for arbitration shall specify the matters which are in question, or subject of the dispute or difference as also the amount of claim item wise. Only such dispute(s) or difference(s) in respect of which the demand has been made, together with counter claims or set off, given by the Railway, shall be referred to arbitration and other matters shall not be included in the reference.
- (ii)(a)** The arbitration proceedings shall be assumed to have commenced from the day, a written and valid demand for arbitration is received by the Railway.
- (b)** The claimant shall submit his claim stating the facts supporting the claims along with all the relevant documents and the relief or remedy sought against each claim within a period of 30 days from the date of appointment of the Arbitral Tribunal.
- (c)** The Railway shall submit its defence statement and counter claim(s), if any, within a period of 60 days of receipt of copy of claims from Tribunal thereafter, unless otherwise extension has been granted by Tribunal.
- (d)** The place of arbitration would be New Delhi
- (iii)** No new claim shall be added during proceedings by either party. However, a party may amend or supplement the original claim or defence thereof during the

course of arbitration proceedings subject to acceptance by Tribunal having due regard to the delay in making it.

- (iv) If the contractor(s) does/do not prefer his/their specific and final claims in writing, within a period of 90 days of receiving the intimation from the Railways that the final bill is ready for payment, he/they will be deemed to have waived his/their claim(s) and the Railway shall be discharged and released of all liabilities under the contract in respect of these claims.

**64 (2)**

**Obligation During Pendency of Arbitration** – Work under the contract shall, unless otherwise directed by the Engineer, continue during the arbitration proceedings, and no payment due or payable by the Railway shall be withheld on account of such proceedings, provided, however, it shall be open for Arbitral Tribunal to consider the decide whether or not such work should continue during arbitration proceedings.

**64 (3)**

- (a)(i) For value of claims upto 1.5 crore a sole arbitrator shall be appointed out of a panel of arbitrators. For claims above Rs.1.5 crore, the arbitral tribunal will comprise three Members, one each to be appointed by DFCCIL and the contractor. The Third member, who will also act as the presiding member, will be appointed by mutual consent of the first two members. If these two members fail to reach an agreement on the third member then, on request by either or both parties, appointment will be made by the Managing Director/DFCCIL. The sole arbitrator shall be appointed within 60 days from the day when a written and valid demand for arbitrator is received by MD/DFCCIL.

(a)(ii) The Arbitral Tribunal shall consist of a Panel of three officials, as the arbitrators. For this purpose, the DFCCIL will send a panel of more than 3 names of DFCCIL officers which may also include the name(s) of Officer(s) empanelled to work as Arbitrator to the contractor within 60 days from the day when a written and valid demand for arbitration is received by the MD. Contractor will be asked to suggest to MD at least 2 names out of the panel for appointment as contractor's nominee within 30 days from the date of dispatch of the request by Railway /DFCCIL. The MD shall appoint at least one out of them as the contractor's nominee and will, also simultaneously appoint the balance number of arbitrators either from the panel or from outside the panel, duly indicating the 'presiding arbitrator' from amongst the 3 arbitrators so appointed. MD shall complete this exercise of appointing the Arbitral Tribunal within 30 days from the receipt of the names of contractor's nominees. While nominating the arbitrators it will be necessary to ensure that one of them is from the Accounts department.

- (a)(iii)** If one or more of the arbitrators appointed as above refuses to act as arbitrator, withdraws from his office as arbitrator, or vacates his/their office/offices or is/are unable or unwilling to perform his functions as arbitrator for any reason whatsoever or dies or in the opinion of the MD fails to act without undue delay, the MD shall appoint new arbitrator/arbitrators to act in his/their place in the same manner in which the earlier arbitrator/arbitrators had been appointed. Such re-constituted Tribunal may, at its discretion, proceed with the reference from the stage at which it was left by the previous arbitrator(s).
- (a)(iv)** The arbitral Tribunal shall have power to call for such evidence by way of affidavits or otherwise as the arbitral Tribunal shall think proper, and it shall be the duty of the parties hereto to do or cause to be done all such things as may be necessary to enable the arbitral Tribunal to make the award without any delay. The arbitral Tribunal should day-to-day proceedings. The proceedings shall normally be conducted on the basis of documents and written statements.
- (a)(v)** While appointing arbitrator(s) under sub-clause (i), (ii) & (iii) above, due care shall be taken that he/they is/are not the one/those who had an opportunity to deal with the matters to which the contract relates or who in the course of his/their duties as Railway servant(s) expressed views on all or any of the matters under dispute or differences. The proceedings of the arbitral Tribunal or the award made by such Tribunal will, however, not be invalid merely for the reason that one or more arbitrator had, in the course of his service, opportunity to deal with the matters to which the contract relates or who in the course of his/their duties expressed views on all or any of the matters under dispute.
- (b)(i)** The arbitral award shall state item wise, the sum and reasons upon which it is based. The analysis and reasons shall be detailed enough so that the award could be inferred there from.
- (b)(ii)** A party may apply for corrections of any computational errors, any typographical or clerical errors or any other error of similar nature occurring in the award of a tribunal and interpretation of a specific point of award to tribunal within 60 days of receipt of the award.
- (b)(iii)** A party may apply to tribunal within 60 days of receipt of award to make an additional award as to claims presented in the arbitral proceedings but omitted from the arbitral award.
- 64 (4)** In case of the Tribunal, comprising of three Members, any ruling on award shall be made by a majority of Members of Tribunal. In the absence of such a majority, the views of the Presiding Arbitrator shall prevail.

- 64(5)** Where the arbitral award is for the payment of money, no interest shall be payable on whole or any part of the money for any period till the date on which the award is made.
- 64(6)** The cost of arbitration shall be borne by the respective parties. The cost shall inter-alia include fee of the arbitrator(s), as per the rates fixed by the DFCCIL from time to time and the fee shall be borne equally by both the parties.
- 64(7)** Subject to the provisions of the aforesaid Arbitration and Conciliation Act 1996 and the rules there under and any statutory modifications thereof shall apply to the arbitration proceedings under this clause.

**65. JOINT VENTURE (JV) FIRMS IN WORKS TENDERS:**

Participation of Joint Venture (JV) Firms in Works Tender: This Clause shall be applicable for works tenders of value as approved and communicated by Railway Board from time to time.

- 65.1.** Separate/name shall be given to the Joint Venture Firm.
- 65.2** Number of members in a JV Firm shall not be more than three.
- 65.3** A member of JV Firm shall not be permitted to participate either in individual capacity or as a member of another JV Firm in the same tender.
- 65.4** The tender form shall be purchased and submitted only in the name of the JV Firm and not in the name of any constituent member.
- 65.5** Normally Earnest Money Deposit (EMD) shall be submitted only in the name of the JV Firm and not in the name of constituent member. However, in exceptional cases EMD in the name of Lead Member can be accepted subject to submission of specific request letter from Lead Member stating the reasons for not submitting EMD in the name of JV Firm and giving written confirmation from JV members to the effect that EMD submitted by the Lead Member may be deemed as EMD submitted by JV Firm.
- 65.6** One of the members of the JV Firm shall be its Lead Member who shall have a majority (at least 51%) share of interest in the JV Firm and also, must have satisfactorily completed in the last three previous financial years and the current financial year up to the date of opening of the tender, one similar single work for a minimum value of 35% of advertised tender value. This condition can also be satisfied by an existing JV firm. In case of JV Firm with foreign member(s), the Lead Member has to be an Indian Firm with a minimum share of 51%. The other members shall have a share of not less than 20% each in case of JV Firms with up to three members.

- 65.7** A copy of Memorandum of Understanding (MoU) executed by the JV members shall be submitted by the JV Firm along with the tender. The complete details of the members of the JV Firm, their share and responsibility in the JV Firm etc. particularly with reference to financial, technical and other obligations shall be furnished in the MoU.(The MoU format for this purpose shall be finalized by the Railway in consultation with their Law Branch and shall be closed along with the tender).
- 65.8** Once the tender is submitted, the MoU shall not be modified/alterd/terminated during the validity of the tender. In case the tenderer fails to observe/comply with this stipulation, the full Earnest Money Deposit (EMD) shall be liable to be forfeited.
- 65.9** Approval for change of constitution of JV Firm shall be at the sole discretion of the Employer (Railways).The constitution of the JV Firm shall not be allowed be modified after submission of the tender bid by the JV Firm, except when modification becomes inevitable due to succession laws etc. and in any case the minimum eligibility criteria should not get vitiated. However, the Lead Member shall continue to be the Lead Member of the JV Firm. Failure to observe this requirement would render the offer in valid.
- 65.10** Similarly, after the contract is awarded, the constitution of JV Firm shall not be allowed to be altered during the currency of contract except when modification become inevitable due to succession laws etc. and in any case the minimum eligibility criteria should not get vitiated. Failure to observe this stipulation shall be deemed to be breach of contract with all consequential penal action as per contract conditions.
- 65.11** On award of contract to a JV Firm, a single Performance Guarantees hall be submitted by the JV Firm as per tender conditions. All the Guarantees like Performance Guarantee, Bank Guarantee for Mobilization Advance, Machinery Advance etc. shall be accepted only in the name of the JV Firm and no splitting of guarantees amongst the members of the JV Firm shall be permitted.
- 65.12** On issue of LOA (Letter Of Acceptance), an agreement among the members of the JV Firm (to whom the work has been awarded) shall be executed and got registered before the Registrar of the Companies under Companies Act or before the Registrar/Sub-Registrar under the Registration Act, 1908. This JV Agreement shall be submitted by the JV Firm to the Railways before signing the contract agreement for the work. In case the tenderer fails to observe/comply with this stipulation, the full Earnest Money Deposit (EMD) shall be forfeited and other penal actions due shall be taken against partners of the JV and the JV. This Joint Venture Agreement shall have, inter-alia, following Clauses:

**65.12.1 Joint And Several Liability**- Members of the JV Firm to which the contract is awarded, shall be jointly and severally liable to the Employer(Railways)for execution of the project in accordance with General and Special Conditions of Contract. The JV members shall also be liable jointly and severally for the loss, damages caused to the Railways during the course of execution of the contractor due to non-execution of the contract or par thereof.

**65.12.2 Duration of the Joint Venture Agreement**-Its hall be valid during the entire currency of the contract including the period of extension, if any and the maintenance period after the work is completed.

**65.12.3 Governing Laws**- The Joint Venture Agreement shall in all respect be governed by and interpreted in accordance with Indian Laws.

**65.13 Authorized Member**-Joint Venture members shall authorize one of the members on behalf of the Joint Venture Firm to deal with the tender, sign the agreement or enter into contract in respect of the said tender, to receive payment, to witness joint measurement of work done, to sign measurement books and similar such action in respect to the said tender/contract. All notices/correspondences with respect to the contract would be sent only to this authorized member of the JV Firm.

**65.14** No member of the Joint Venture Firm shall have the right to assign or transfer the interest right or liability in the contract without the written consent of the other members and that of the employer (Railways) in respect of the said tender/contract.

**65.15** Documents to be enclosed by the JV Firm along with the tender:

**65.15.1** In case one or more of the members of the JV Firm is/are partnership firm(s), following documents shall be submitted:

- (a) Notary certified copy of the Partnership Deed,
- (b) Consent of all the partners to enter in to the Joint Venture Agreement on a stamp paper of appropriate value (inoriginal)
- (c) Power of Attorney (duly registered as per prevailing law) in favour of one of the partners of the partnership firm to sign the JV Agreement on behalf of the partnership firm and create liability against the firm.

**65.15.2** In case one or more members is/are Proprietary Firm or HUF, the following documents shall be enclosed:

Affidavit on Stamp Paper of appropriate value declaring that his/her Concern is a Proprietary Concern and he/she is sole proprietor of the Concern OR he/she is

in position of "KARTA" of Hindu Undivided Family (HUF) and he/she has the authority, power and consent given by other partners to act on behalf of HUF.

**65.15.3** In case one or more members is/are limited companies, the following documents shall be submitted:

- (a) Notary certified copy of resolutions of the Directors of the Company, permitting the company to enter in to a JV agreement, authorizing MD or one of the Directors or Managers of the Company to sign JV Agreement, such other documents required to be signed on behalf of the Company and enter in to liability against the company and/or do any other act on behalf of the company.
- (b) Copy of Memorandum and Articles of Association of the Company.
- (c) Power of Attorney(duly registered as per prevailing law) by the Company authorizing the person to do/act mentioned in the para (a)above.

**65.15.4** All the Members of JV shall certify that they are not black listed or debarred by Railways or any other Ministry/ Department of the Govt.of India/State Govt. From participation in tenders/contract on the date of opening of bids either in their individual capacity as members of the JV or the JV Firm in which they were/are members.

**65.16** **Credentials & Qualifying Criteria:** Technical and financial eligibility of the JV Firm shall be adjudged based on satisfactory fulfillment of the following criteria:

**65.16.1 Technical Eligibility Criteria (mentioned hereunder):**

Either the existing JV Firm or Lead Member of the JV Firm must have satisfactorily completed in the last three previous financial years and the current financial year up to the date of opening of the tender, one similar single work for a minimum of 35% of advertised value of the tender.

**The meaning of "similar work" for this work is "Construction of Residential and service buildings in RCC Raft/Pile/Open foundations and Framed/Load bearing Structures."**

**Note:** Value of a completed work done by a Member in an earlier JV Firms shall be reckoned only to the extent of the concerned member's share in that JV Firm for the purpose of satisfying his/her compliance to the above mentioned technical eligibility criteria in the tender under consideration.

**65.16.2 Financial Eligibility Criteria:**

The contractual payments received by the JV Firm or the arithmetic sum of contractual payments received by all the members of JV Firm in the previous three financial years and the current financial year upto the date of opening of tender shall be at least 150% of the estimated value of the work as mentioned in the tender.

**Note:** Contractual payment received by a Member in an earlier JV Firm shall be reckoned only to the extent of the concerned member's share in that JV Firm for the purpose of satisfying compliance of the above mentioned financial eligibility criteria in tender under consideration

(Authority: Railway Board's letter no. 2002/CE-I/CT/37, Dated 07.09.2011)



## (B) SPECIAL CONDITIONS OF CONTRACT

**1.2.1** This Tender shall be governed by Preamble and General, Special conditions, Technical Specifications.

**1.2.2** If there are varying or conflicting provisions in the documents forming part of the contract. Engineer shall be deciding authority with regard to the intentions of the provision and decision of Engineer will be final and binding on the contractor.

**1.2.3 (a). Scope of Work** – The tentative scope of work shall be as under:

S.No	Description of utilities	Unit/Qty
1	Construction of Type II Quarters	115
2	Construction of Type III Quarters	6
3	Construction of Station Building	3
4	Construction of Toilets, Relay-rooms, Water booth, OFC room and Store Sheds, Platform Shed etc.	

The above scope is tentative and during the execution of work the Number and Type of utility may change.

**(b). Scheme of work** – The bidder must submit the detailed programme for the execution of the work under this contract. A detailed PERT chart shall be submitted by the bidder before the commencement of the work. The bidder must also submit the method statement for the completion of work.

### 1.2.4 Quality Assurance Programme:

The contractor shall submit a Quality Assurance Programme within 15 days of signing of the contract agreement. For proper control of quality and to ensure that the materials, equipments and fittings are manufactured according to specifications and the construction according to approved instructions, drawings, specifications, the Contractor shall adopt a suitable Quality Assurance Programme to ensure quality at all necessary points, whether at manufacturer's works, or in his depot or at work site as well as during construction. Such Quality Assurance Programme shall also meet the requirement of the employer's prescribed quality Assurance Standards. The detailed Quality assurance plan for all the activities involved in the work shall be as per the requirement of employer.

#### 1.2.4.1(a) Quality Assurance of Materials –

All the equipments, materials, fittings and component will be subject to quality control programme of manufacturer, being a part of the Quality Assurance Programme of the Contractor. **The materials may also be inspected by the Employer or his representative either at the construction site or at the Contractors' depot.** The Engineer or his representative shall have the right to be present during all the stages of construction and shall be afforded free of charge all reasonable facilities for inspection and testing as well as to examine the inspection report of the manufacturer in addition to the quality audit which the Contractor may institute as a part of his programme so as to satisfy himself that the materials are in accordance with specifications, approved drawings and designs and Employer's prescribed Quality Assurance Standards.

(b) The decision of the Engineer shall be final in respect of acceptability or otherwise of any material, fittings, component or equipment required for the work.

#### **1.2.5 SPECIFICATIONS AND DRAWINGS:**

##### **(a) ADHEDRENCE TO SPECIFICATION AND DRAWINGS:**

The whole of the works shall be executed in perfect conformity with the specifications and drawings. If the contractor performs any work in a manner contrary to the specifications or drawings he shall bear all the costs arising or originating there from, and shall be responsible for all loss to the DFCCIL.

(b) **DRAWINGS AND SPECIFICATIONS OF THE WORKS:** The contractor shall keep one copy of drawings and specifications at the site, in good order, and such other contract documents as may be necessary, available to the Engineer and the Engineer's representative.

(c) **MEANING AND INTENT OF SPECIFICATION AND DRAWINGS:** If any ambiguity arises as to the meaning and intent of any portion of the specifications and drawings or as to execution or quality of any work or material or as to the measurements of the works, the decision of the Engineer/Engineer's representative there shall be final subject to appeal within seven days of such decision being intimated by the contractors to the CPM/Ambala/DFCCIL who shall have the power to correct any errors, omissions or discrepancies in the specifications, drawings, classification or work or materials, and whose decision in the matter in dispute or doubt shall be final , conclusive and binding .

#### **1.2.6 Traffic Blocks/Power Blocks/Shut Down:**

- a. The contractor shall obtain Power/Traffic/Shut down in the name of authorized representative of DFCCIL. Engineer/Engineer's representative will facilitate to make arrangements to obtain power blocks/shut down (hereinafter referred to as blocks) for works to be carried out along or adjacent to the track work. Work will be done day & night on war footing level with the approval of the Engineer/Engineer's representative.

- b. Blocks may be granted during day or night hours continuous. The Contractor shall confirm that he will equip himself to carry out all construction during night blocks efficiently by suitable special lighting equipments without any extra cost.
- c. Block period shall be counted from the time the TR-line is placed at the Contractor's disposal at the work-spot till it is cleared by the Contractor.
- d. Blocks shall be subject to normal operating conditions and rules of the Railway. All formalities of exchanging private number etc with the traffic control/traction power controller will be carried out by the Engineer's staff who shall be responsible for imposing power blocks/shut down and also removing the same after men, material and equipment have been cleared by the Contractor from running tracks and the same declared safe for traffic by Engineer/Engineer's representative in case of works involving safety of running tracks.

#### 1.2.7 Work by Other Agencies

- a. Any other works undertaken at the same time by the Engineer directly or through some other agency at the same time or section where the contractor is carrying out his work will not entitle the contractor to prefer any claim regarding any delays or hindrances he may have to face on this account but the Employer shall grant a reasonable extension of time to the contractor. The contractor shall comply with any instruction which may be given to him by the Employer in order to permit simultaneous execution of his own works and those undertaken by other contractors or the DFCCIL without being entitled on this account on any extra charge.
- b. The contractor shall not be entitled to any extra payment due to hindrance resulting from normal Railway operations, such as delay on account of adequate number of and duration of blocks not being granted, operational delay in movement of work trains extension of time to the contractor.

#### 1.2.8 Safety measures –

##### **Fencing at work site:**

Contractor(s) while executing the work shall provide suitable fencing/barricading to protect/segregate the existing Railway line/Building/Structure from any damage and un- toward incident, as per the directions or plan approved by Engineer-in-charge, except for the permanent barricading as mentioned in NS-1 of Schedule B of Financial Bid. Decision of the Engineer-in-charge shall be final and binding regarding the identification of location/ item for the payment under NS-1 of Schedule-B of Financial Bid.

**Safety Gear:**

During execution of the work, contractors shall ensure that all safety precautions are taken by their men to protect themselves and site to prevent any untoward incident. In this regard contractor will ensure that adequate number of safety helmets, safety belts, safety jackets with reflective arm band, rope, ladders emergency light, red hand flags, red hand lamps, banner flags & whistles etc. are available at site before the work is actually started. The above list is only indicative and is not exhaustive and arrangement of the safety items as per the requirement will be the sole responsibility of the contractor. Railway reserve the right to stop the work in the absence of proper safety gear and no claim shall be entertained in this regard; decision of the Engineer will be final and binding upon the contractor. The cost of all the safety gear is deemed to have been included in the rates quoted and nothing extra is payable under this contract.

Following points shall be kept in mind during the execution of the present contract at site.

- a). The contractor shall take all precautionary measures in order to ensure the protection of his own personnel moving about or working on the railway premises, but shall then conform to the rules and regulations of the railway if and when, in the course of the work there is likely to be any danger to persons in the employment of the contractor due to running traffic while working in the Railway siding and premises, the contractor shall provide flagman or look out men for protection of such persons. The Employer shall remain indemnified by the contractor in the event of any accident occurring in the normal course of work, arising out of the failure of contractor or his men to exercise reasonable precaution at all places of work.
- b). Blasting of rocks for foundation work shall be done only after due notice is given to the employer and time/s and date /s for blasting operations agreed to by the employer . Blasting, if required to be done in the vicinity of the track, shall not be undertaken until the Employer's flagmen on duty take necessary step to protect trains and the track is adequately protected by the contractor against damage by blasted rock .The contractor shall follow detailed instructions which will be issued to him regarding blasting operations in the vicinity of tracks.
- c) The contractor shall abide by all Railway regulations in force for the time being and ensure that the same are followed by his representatives, Agents or sub-contractors or workmen. He shall give due notice to his employees and workers about provision of this para.

- d) The works must be carried out most carefully without any infringement of the Indian Railway Act or the General and Subsidiary Rules in force on the Railway, in such a way that they do not hinder Railway operation or affect the proper functioning of or damage any Railway equipment, structure or rolling stock except as agreed to by the employer, provided that all damage and disfiguration caused by the contractor at his own cost failing which cost of such repairs shall be recovered from the contractor.
- e). If safety of track or track drainage etc. is affected as a consequence of works undertaken by the contractor, the contractor shall take immediate steps to restore normal conditions. In case of delay, the employer shall, take necessary steps and recover the costs from the contractor.
- f) The contractor shall be responsible for safe custody of all works/equipments till provisional acceptance.

**1.2.9 Guarantee/defect liability period: –**

- a) The Contractor shall guarantee that all the equipments and works executed under this contract shall be free from all defects and faults in material, design, workmanship and manufacture and shall be of acceptable standards for the contracted work and in full conformity with the technical specifications, drawings and other contract stipulations, **during construction and after 6 months from date of completion of work.**
- b) During the period of guarantee/ defect liability the Contractor shall keep available an experienced engineer/ man power and necessary equipment to attend to any defective installation resulting from defective construction by the Contractor. This engineer shall not attend to rectification of defects which arise within the purview of routine maintenance work. The contractor shall bear the cost of modifications, additions or substitutions in the structure, which may be considered necessary due to faulty materials or workmanship. The final decision shall rest with the Chief Project Manager/ or his successor(s)/Nominee.
- c) During the period of Guarantee the Contractor shall be liable for the replacement at site of any parts which may be found defective in the equipment/structure whether such equipment/ defective construction is carried out by contractor or by his authorised sub-contractor whether arising from faulty design, materials, workmanship or negligence in any manner on the part of the Contractor provided always that such defective construction are not repairable at site are to be promptly dismantled and reconstructed at his (Contractor's) own expenses. In case of defects in Contractor's equipment/construction detected during guarantee period, contractor should replace all such equipments or defective structures/ part of structure irrespective of the fact whether all such items have failed or not. The Contractor shall bear the cost of repairs carried out on his

behalf by the Employer at site. In such a case, the contractor shall be informed in advance of the works proposed to be carried out by the Employer.

- d) If it becomes necessary for the Contractor to replace or renew any defective portion of the equipment/ structure/ part of structure under the para aforesaid then the provision of the said para shall also apply to the portions of the equipment/ structure/ part of structure so replaced or renewed until the expiration of six month from the date of such replacement or renewal or until the end of the above mentioned period whichever is later. Such extension shall not apply in case of defects of a minor nature, the decision of the Chief Project Manager/Ambala/DFCCIL or his successor/nominee being final in the matter. If any defect be not remedied within a reasonable time during the aforesaid period the Employer may proceed to do work at the Contractor's risk and expense, but without prejudice to any other rights and remedies which the Employer may have against the Contractor in respect of such defects or faults.

#### **1.2.10 Payment**

Payment will be governed in accordance with accepted schedule of prices, read with relevant para of the other parts and Chapters of the Tender Papers. The employer retains the right to withhold money due to the contractor arising out of this contract for any default of the contractor from other contracts which the contractor may have with the Government of India.

- i) The Contractor shall, whenever required, produce or cause to be produced for examination by the Employer any quotation/invoice, cost of other account, book of account, voucher, receipt letter, memorandum paper or writing or any copy of or extract from any such document and also furnish information and returns verified in such manner as may be required in anyway relating to the execution of this contract or relevant for verifying or ascertaining the cost of the execution of this Contract (the decision of the employer on the question of relevancy of any documents, information or return being final and binding on the parties). The Contractor shall similarly produce vouchers etc., if required, to prove to the Employer that materials supplied by him are in accordance with the specifications laid down in the contract.
- ii) If any portion of the work be carried out by a sub-contractor or any subsidiary or allied firm or company the Employer shall have power to secure the books of such sub-contractor or any subsidiary or allied firm or company, through the Contractor, and such books shall be open to his inspection. The Contractor should seek prior permission from the employer for subletting whole and/or part of the work to any sub-contractor.

- iii) The obligations imposed by sub-clause (i) and (ii) above are without prejudice to the obligation of the Contractor under any statute, rules or order binding to the Contractor or other conditions of the contract.
- iv) It is an agreed term of the contract that the employer reserves the right to carry out post-payment Audit and/or technical examination of the works and the final bill, including all supporting vouchers, abstracts etc. and to make a claim on the Contractor for the refund of any excess amount paid to him if as a result of such examination any over payment to him is discovered to have been made in respect of any work done or alleged to have been done by him under the contract.
- v) All payments in respect of the contract during the currency of the contract shall be made through Electronic clearing system (ECS)/Electronic funds transfer (EFT). The successful tenderer on award of contract must submit ECS/EFT Mandate Form complete in all respects as detailed at Form-16 of the tender document. However, if the facility of ECS/EFT is not available at a particular location, the payments shall be made by cheque.

**1.2.11 Variation In Quantities During Execution Of Works Contracts**– The procedure detailed below shall be adopted for dealing with variations in quantities during execution of works contracts:

1. All individual items in this contract shall be operated with variation of plus or minus 25% and payment would be made as per the agreement rate.
2. In case increase in quantity of an individual item by more than 25% of the agreement quantity is considered unavoidable, the same shall be got executed by floating a fresh tender. If floating a fresh tender for operating that item is considered not practicable, quantity of that item will be operated in excess of 125% of the agreement quantity subject to the following conditions:
  - a) Operation of an item by more than 125% of the agreement quantity needs the approval of an officer of the rank not less than CPM.
    - (i) Quantities operated in excess of 125% but upto 140% of the agreement quantity of the concerned item, shall be paid at 98% of the rate awarded for that item in that particular tender.
    - (ii) Quantities operated in excess of 140% but upto 150% of the agreement quantity of the concerned item shall be paid at 96% of the rate awarded for that item in that particular tender.
    - (iii) Variation in individual items beyond 150% will be prohibited and would

be permitted only in exceptional unavoidable circumstances and shall be paid at 96% of the rate awarded for that item in that particular tender.

(b) The variation in quantities as per the above formula will apply only to the Individual items of the contract and not on the overall contract value.

(c) Execution of quantities beyond 150% of the overall agreement value shall not be permitted and if found necessary, shall be only through fresh tenders or by negotiation with existing contractor.

3. In cases where decrease is involved during execution of contract:

(a) The contract signing authority can decrease the items upto 25% of individual item.

(b) For decrease beyond 25% for individual items or 25% of contract agreement value, the approval of an officer not less than rank of CPM/DFCCIL may be taken, after obtaining 'No Claim Certificate' from the contractor, giving detailed reasons for each such decrease in the quantities.

(c) It should be certified that the work proposed to be reduced will not be required in the same work.

4. The limit for varying quantities for minor value items shall be 100% (as against 25% prescribed for other items). A minor value item for this purpose is defined as an item whose original agreement value is less than 1% of the total original agreement value.

5. No such quantity variation limit shall apply for foundation items.

**1.2.12 Performance Guarantee:**

(i) The successful bidder shall be required to furnish to DFCCIL ,a performance Guarantee within 15 days of the receipt of letter of Acceptance, in an amount equivalent to 5%(five Percent) of the contract price. The performance Guarantee to be provided by the successful bidder in the form of a bank guarantee as per prescribed format shall be issued from any Nationalized/Indian Scheduled Commercial Bank. In case of Joint Venture (JV) the Bank Guarantee towards performance Guarantee shall be provided by JV.

(ii) The Bank Guarantee for performance Guarantee shall remain valid until a date 60 days (or as specified in the Contract) after stipulated date of completion.

(iii) The Bank Guarantee for performance Guarantee shall be submitted invariably in the format given in the bidding document.



The Performance Guarantee shall be in favor of '**Dedicated Freight Corridor Corporation of India Ltd.**'

- (a) The performance Guarantee shall be released 21 days after issue of performance certificate. The security deposit, however, shall be released only after the expiry of the guarantee/defect liability period and after passing the final bill based on "No Claim Certificate"
- (b) Wherever the contract is rescinded due to failure of Contractor, the security deposit shall be forfeited and the Performance Guarantee shall be encashed and the balance work shall be got done independently without risk and cost. The failed contractor shall be debarred from participating in the tender for executing the balance work. If the failed contractor is a JV or a partnership firm, then every member/partner of such a firm shall be debarred from participating in the tender for the balance work either in his/her individual capacity or as a partner of any other JV/Partnership firm.
- (c) The Employer shall not make a claim under the Performance Guarantee except for amounts to which the employer is entitled under the contract (not withstanding and/or without prejudice to any other provisions in the contract agreement) in the event of:
  - (i) Failure by the contractor to extend the validity of the Performance Guarantee as described herein above, in which event the Engineer may claim the full amount of the Performance Guarantee.
  - (ii) Failure by the contractor to pay DFCCIL amount due, either agreed by the contractor or determined under any of the Clauses/Conditions of the agreement, within 30 days of the service of notice to this effect by Engineer.
  - (iii) The contract being determined or rescinded under provision of the GCC, the Performance Guarantee shall be forfeited in full and shall be absolutely at the disposal of the DFCCIL.
- (d) The value of Performance Guarantee to be submitted by the contractor will not change for variation upto 25% (either increase or decrease). In case during the course of execution, value of the contract increases by more than 25% of the original contract value, an additional Performance Guarantee amounting to 5% ( five percent) for the excess value over the original contract value shall be deposited by the contractor.

### **1.2.13 Settlement of Disputes:-**

The settlement of disputes shall be through Arbitration, as per clause 64 of General Conditions of Contract (Part 1, Chapter II, (A) General Conditions of contract)

**1.2.13.1 Settlement through Court:**

It is a term of this contract that the tenderer shall not approach any court of law for settlement of such disputes or differences unless an attempt has first been made by the parties to settle such disputes or differences.

**1.2.13.2 Suspension of Work:**

The obligation of the Employer, the Engineer and the tenderer shall not be altered by reasons or Conciliation/ Arbitration being conducted during the progress of works. No party shall be entitled to suspend the work on account of Conciliation/ Arbitration and payments to the tenderer shall continue to be made in terms of the contract.

**1.2.13.3 Award to be binding on all parties**

The award of the Sole Arbitrator, unless challenged in court of law, shall be binding on all parties.

**1.2.13.4 Exception:**

For settlement of disputes with central PSUs, the procedure as per existing orders or Permanent Machinery for Arbitration (PMA), Bureau of Public Enterprises, Govt. of India shall be followed.

**1.2.13.5 Jurisdiction of Courts:**

Jurisdiction of courts for dispute resolution shall be New Delhi only.

**1.2.14 DEPLOYMENT OF ENGINEERS**

The Contractor shall provide and keep on the works, during the execution of the works, following minimum number of efficient and competent Engineers, supervisory staff etc. to ensure that the work is executed strictly as per provisions of the Contract.

S. No.	Category	Numbers
1	Project Manager/ Senior Engineer ( Degree in Civil Engg with minimum 10yrs experience)	01
2	Site Engineer ( Degree/diploma holders with 3-5 years experience)	03 (2 civil + 1 Electrical Engineers)
3	Quality Engineer ( Degree with 5 Years Experience )	01

DFCC /UMB

UTILITY SHIFTING-HR

---

4	Quantity Surveyor ( Degree/ Diploma with 5 years experience)	01
5	Supervisors	As per requirement
6	Safety Supervisor (Degree/Diploma in Engg. With 3-5 years of working experience)	01

**1.2.15 The bidder/ any partner of JV/Partnership firm or agency deployed by it/them for electrical works must have License for Electrical Works.**

**PART-I**

**CHAPTER - III**

**PRICE AND PAYMENT**

**1.3.1 Scope**

This chapter deals with prices to be paid for construction/supply and/or erection of various items of work or for Work/supplies and other amounts payable in accordance with accepted schedule of prices and rates and terms and conditions of payment mentioned herein. This is a works contract. The total prices for the completed items of work are the actual prices payable to the contractor as per the terms and conditions of the contract.

**1.3.2 Schedule of Prices**

**(a) Prices for items**

The tenderers are required to quote percentage below/at par/above against each schedule.

**(b) Unit Prices for Materials**

The prices offered in tender shall include all Taxes, Duties and levies (including Octroi etc.) applicable on this works contract. Therefore, they should quote their prices taking into account, the rate of taxes as leviable in the event of sale through works contract to the Central Government Organization in that state. The prices shall also include provision for losses and wastage in transit.

**(c) PRICE VARIATION CLAUSE:**

The price variation shall be admissible as under:

**A. Price Variation Clause (PVC):**

- A.1 Price Variation Clause (PVC) shall be applicable only for tenders of value as prescribed by the Ministry of Railways through instructions/circulars issued from time to time and irrespective of the contract completion period. Materials supplied free of cost by Railway to the contractors shall fall outside the purview of Price Variation Clause. If, in any case, accepted offer includes some specific payment to be made to consultants or some materials supplied by Railway free or at fixed rate, such payments shall be excluded from the gross value of the work for the purpose of payment/recovery of price variation.
-

- A.2 The Base Month for 'Price Variation Clause' shall be taken as month of opening of tender including extensions, if any, unless otherwise stated elsewhere. The quarter for applicability of PVC shall commence from the month following the month of opening of tender. The Price Variation shall be based on the average Price Index of the quarter under consideration
- A.3 Rates accepted by Railway Administration shall hold good till completion of work and no additional individual claim shall be admissible on account of fluctuations in market rates, increase in taxes/any other levies/tolls etc. except that payment/recovery for overall market situation shall be made as per Price Variation Clause given hereunder.
- A.4 Adjustment for variation in prices of material, labour, fuel, explosives, detonators, steel, concreting, ferrous, non-ferrous, insulators, zinc and cement shall be determined in the manner prescribed.
- A.5 Components of various items in a contract on which variation in prices be admissible, shall be Material, Labour, Fuel, Explosives, Detonators, Steel, Cement, Concreting, Ferrous, Non-ferrous, Insulator, Zinc, Erection etc. However, for fixed components, no price variation shall be admissible.
- A.6 The percentages of labour component, material component, fuel component etc. in various types of Engineering Works shall be as:

Component	Percentage	Component	Percentage
<b>(A) Earthwork Contracts:</b>			
Labour Component	50%	Other Material Components	15%
Fuel Component	20%	Fixed Component*	15%
<b>(B) Ballast and Quarry Products Contracts:</b>			
Labour Component	55%	Other Material Components	15%
Fuel Component	15%	Fixed Component*	15%
<b>(C) Tunnelling Contracts:</b>			
Labour Component	45%	Detonators Component	5%
Fuel Component	15%	Other Material Components	5%
Explosive Component	15%	Fixed Component*	15%
<b>(D) Other Works Contracts:</b>			
Labour Component	30%	Fuel Component	15%

Material Component	40%	Fixed Component*	15%
--------------------	-----	------------------	-----

**\* It shall not be considered for any price variation.**

**Note: 1. This work shall be considered under “ (D) Other Works Contracts.” Of the table above.**

**2. No price variation shall be paid for Electrical Works.**

A.7 The Amount of variation in prices in several components (labour material etc.) shall be worked out by the following formulae:

$$(i) \quad L = \frac{R \times (I - I_o) \times P}{I_o \times 100}$$

$$(ii) \quad M = \frac{R \times (W - W_o) \times Q}{W_o \times 100}$$

$$(iii) \quad U = \frac{R \times (F - F_o) \times Z}{F_o \times 100}$$

$$(iv) \quad Ms = O \times (Bs - Bso)$$

$$(v) \quad Mc = \frac{A \times (Wc - Wco)}{Wco}$$

Where,

L Amount of price variation in Labour  
M Amount of price variation in Materials  
U Amount of price variation in Fuel  
Ms Amount of price variation in Steel  
Mc Amount of price variation in Cement

O Weight of steel in tones supplied by the contractor as per the 'on-account' bill for the month under consideration

R Gross value of work done by contractor as per on-account bill(s) excluding cost of materials supplied by Railway at fixed price minus the price values of cement and steel.

A Value of Cement supplied by Contractor as per on account bill in the quarter under consideration

Io Consumer Price Index Number for Industrial Workers- All India- Published in R.B.I. Bulletin for the base period

I Consumer Price Index Number for Industrial Workers- All India- Published in R.B.I. Bulletin for the average price index of the 3 months of the quarter under consideration

Wo Index Number of Wholesale Prices – By Groups and Sub-Groups – All commodities – as published in the R.B.I. Bulletin for the base period

## UTILITY SHIFTING-HR

- W Index Number of Wholesale Prices – By Groups and Sub- Groups – All commodities– as published in the R.B.I. Bulletin for the average price index of the 3 months of the quarter under consideration
- Fo Index Number of Wholesale Prices–By Groups and Sub-Groups for Fuel, Power, Light and Lubricants as published in the R.B.I. Bulletin for the base period
- F Index Number of Wholesale Prices–By Groups and Sub-Groups for Fuel, Power, Light and Lubricants as published in the R.B.I. Bulletin for the average price index of the 3 months of the quarter under consideration
- Bs SAIL’s (Steel Authority of India Limited) ex-works price plus Excise Duty thereof (in rupees per tonne) for the relevant category of steel supplied by the contractor as prevailing on the first day of the month in which the steel was purchased by the contractor or as prevailing on the first day of the month in which steel was brought to the site by the contractor which ever is lower.
- Bso SAIL’s ex-works price plus Excise Duty thereof (in Rs. per tonne) for the relevant category of steel supplied by the contractor as prevailing on the first day of the month in which the tender was opened
- Wco Index No. of Wholesale Price of sub-group (of Cement) as published in RBI Bulletin for the base period
- Wc Index No. of Wholesale Price of sub-group (of Cement) as published in RBI Bulletin for the average price index of the 3 months of the quarter under consideration
- P % of Labour component
- Q % of Material component
- Z % of Fuel component
- A.8 The demands for escalation of cost shall be allowed on the basis of provisional indices made available by Reserve Bank of India. Any adjustment needed to be done based on the finally published indices shall be made as and when they become available.
- A.9 Relevant categories of steel for the purpose of operating Price Variation formula, as mentioned in this Clause, based on SAIL’s ex-works price plus Excise Duty thereof, shall be as under:

SL	Category Of Steel Supplied In Railway Work	Category Of Steel Produced By SAIL Whose Ex-Works Price Plus Excise Duty Would Be Adopted To Determine Price Variation
1.	Reinforcement bars and other rounds	<b>TMT 8mm IS 1786 Fe 415/Fe 500</b>
2.	All types and sizes of angles	<b>Angle 65 x 65 x 6 mm IS 2062 E250A SK</b>
3.	All types and sizes of plates	<b>PM Plates above 10-20 mm IS 2062 E250A SK</b>
4.	All types and sizes of channels and joists	<b>Channels 200 x 75 mm IS 2062 E250A SK</b>

5	Any other section of steel not covered in the above categories and excluding HTS	<b>Average of price for the 3 categories covered under SL 1, 2 &amp; 3 above</b>
---	--	--

### **A.10 Price variation During Extended Period of Contract**

The price adjustment as worked out above, i.e. either increase or decrease shall be applicable upto the stipulated date of completion of work including the extended period of completion where such extension has been granted under Clause 17-A of the General Conditions of Contract. However, where extension of time has been granted due to contractor's failure under Clause 17-B of the General Conditions of Contract, price adjustment shall be done as follows:

- (a) In case the indices increase above the indices applicable to the last month of original completion period or the extended period under Clause 17-A, the price adjustment for the period of extension granted under Clause 17-B shall be limited to the amount payable as per the Indices applicable to the last month of the original completion period or the extended period under Clause 17-A of the General Conditions of Contract; as the case may be.
- (b) In case the indices fall below the indices applicable to the last month of original/ extended period of completion under Clause 17-A, as the case may be; then the lower indices shall be adopted for the price adjustment for the period of extension under Clause 17-B of the General Conditions of Contract.

**1.3.3 Price of Equipments, Components, Materials and executions** – The prices of each item shall include cost of material (except where specified otherwise in the item of work), labour, equipment, tools & plant, taxes, lead and lift and all other costs as a complete job for completion of item. The Works Contract tax, Sales tax, Excise duty, VAT, Octroi, Royalty, Toll tax, Levy, or any other tax, taxes/levied by the Central or State Govt. or local bodies, building cess etc shall be borne by the tenderer. No part of such taxes on contractor's labour/materials or any other amount will be paid by DFCCIL. This should be kept in view before tendering.

#### **1.3.4 Income Tax, W/C Tax & Excise duty etc.**

- (a) Under section 194-C of the income Tax Act. 1961 deduction of 2% plus surcharge as applicable on Income Tax will be made for sums paid for carrying out the work under this contract.



- (b) All taxes, duties & levies ( including Octroi etc.) arising out of the transactions between the contractor and his sub-contractors/Suppliers for this work will be included in the rates quoted by the contractor in the relevant schedule.
- (c) Wherever the law makes it statutory for the employer to deduct any amount towards Sales Tax or works contract or other taxes like building cess etc, the same will be deducted and deposited with the concerned authority.

### **1.3.5 Measurements**

- (a) Payment for field work shall be made in accordance with approved designs and drawings and measured in relevant units except where provided for otherwise. In case the dimensions of the work are more than those shown in approved designs and drawings, the contractor will not be entitled to any extra payment, unless dimensions were increased on account of physical impossibility of carrying out the work in accordance with approved drawings and designs. In case the dimensions of work are less than those shown in the approved designs and drawings and the work is accepted without being rejected, payment will be made as per work actually done.
- (b) The measurements will be made generally in accordance with standard engineering practice and in conformity with the explanatory Notes given in Financial Bid .

### **1.3.6 Mobilization Advance:**

**The mobilization advance shall be given for tenders of value Rs 25 crores and above.**

The following conditions will govern the mobilization advance:

- (i) An interest bearing mobilization advance shall be paid to the bidder exclusively for the costs of mobilization at ten percent of contract price on the provision by the bidder of an unconditional bank guarantee of 110 % of the sanctioned advance amount on prescribed format. The Bank guarantee shall be from a nationalized Bank in India or any Scheduled Bank in India.
- (ii) Such bank guarantees shall remain effective until the advance payment has been fully recovered, but the amount thereof shall be progressively reduced by the amount repaid by the bidder, as indicated in the Interim Payment Certificates.
- (iii) This shall be limited to 10% of the contract value and payable in 2 stages as indicated below:

- (a) 5% of the contract value on signing of the contract agreement.
- (b) 5% on mobilization of site establishment, setting up offices, bringing in equipments and actual commencement of work.
- (iv) The rate of interest shall be **4.5%** per annum above the base rate of State Bank of India as effective on the date of approval of payment of Mobilization advance by the Competent Authority.
- (v) The repayment of advances shall be done through percentage deductions from the interim payments. The time of commencement of repayment, rate of deductions from interim payments, and the time by which the advance should be fully repaid will be as under:
  - a. The recovery shall commence when the value of contract executed reached 15% of the original contract value and shall be completed when the value of work executed reaches 85% of the original contract value. The installments on each “on account bill” will be on pro-rata basis.
  - b. Interest shall be recovered on the advance outstanding for the period commencing from the date of payment of advance till date of particular “on account bill” (through which recovery of principle is effected) and adjusted fully against “on account bill” along with pro-rata principle recovery. In the event of any short-fall, the same shall be carried forward to the next “on account bill” and shall attract interest @ 4.5% per annum above the Base Rate of State Bank of India, as affective on the date of approval of payment of advance by the Competent Authority”
- (vi) The advances shall be used by the bidder exclusively for mobilization expenditures, including the acquisition of construction related plant and equipment. Mobilization expenditures mentioned herein shall not include the margin money and bank commission etc. paid by the bidder for procurement of BGs against performance security and mobilization advance etc. Should the bidder misappropriate any portion of the advance, it shall become due and payable immediately, and no further advance will be made to the bidder thereafter. In such cases the bidder shall also be liable for appropriate action under the contract.

### **1.3.7 Release of Security Deposit:**

- (i) After issue of the certificate of acceptance of the entire installation, and after expiry of the guarantee period/Defect Liability Period, the DFCCIL shall release the Security Deposit submitted by the Contractor.

- (ii) The Security deposit shall, however, be liable to be forfeited in case of any breach by the contractor of any of the conditions of the contract for non-completion of the full contract without prejudice to other rights remedies of the employer whether specifically provided herein or otherwise.

XXXXX

**PART – I**

**CHAPTER – IV**

**TECHNICAL SPECIFICATIONS**

**A. Civil Engineering Works**

**1.0 GENERAL**

- 1.01 The specifications and mode of measurements for Civil and plumbing works shall be in accordance with the relevant Railway specifications & mode of measurements with latest edition with upto date correction slips shall be followed.

Unless otherwise specified in the nomenclature of individual item or in these specifications, the entire work shall be carried out as per railway specifications with upto date correction slips upto the date of opening of the Tender.

The tenderers are requested to obtain the copies of the above documents directly from the office of railways/ Bureau of Indian Standards as these Specifications are not being issued along with the tender documents. These specifications with up to date correction slips will form part of the contract agreement to be executed with the successful tenderer.

Metric units have been used in the specifications and on all the drawings.

- 1.02 For the item not covered in the RAILWAY Specifications, the work shall be executed as per latest relevant standard codes published by BIS(formerly ISI) inclusive of all amendments issued thereto or revision, if any, upto the date of opening of tenders.
- 1.03 In case of BIS codes specifications are not available the decision of the Engineer based on acceptable sound engineering practice shall be final and binding on the contractor.
- 1.04 However in the event of any discrepancy in the description of item as given in schedule of quantities or specification appended with the tender and the specifications relating to the relevant item as per Railway specifications mentioned above, or in drawings the decision of Engineer shall be final.
- 1.05 The rates of different items of works shall be for all height, lifts, leads and depths of the building except where otherwise specified in the item of work or in special conditions appended with the Tender.
- 1.06 The work shall be carried out in accordance with the architectural drawings and structural drawings. The structural and architectural drawings shall have to be properly co related before executing the work. In case of any difference noticed between architectural and structural drawing, the contractor shall obtain final

- decision in writing of the Engineer. For the items where so required, samples shall be prepared before starting the particular items of work for prior approval of the engineer and nothing extra shall be payable on this account.
- 1.07 All materials to be used in the works shall bear I.S. Certification marks unless otherwise the make is specified in the item or special conditions appended with tender document. In case IS marked materials mentioned in the tender document are not used due to non availability, the materials used shall confirm to IS code or Railway specifications applicable in this contract. All relevant tests as per Railway specifications and relevant IS codes shall have to be carried out by the contractor at his own cost
- 1.08 In such cases the Engineer shall satisfy himself about the quality of such materials and give his approval in writing. Only articles classified as First Quality by the manufacturer shall be used unless otherwise specified. All materials including ISI marked materials, shall be tested as per provision of the mandatory Tests in Railway specifications and relevant IS specifications. The Engineer may relax the condition regarding testing if the quantity of materials required is small. All relevant tests as per Railway specifications and relevant IS codes shall have to be carried out by the contractor at his own cost.
- 1.09 In respect of works of the sub agencies deployed for doing the work of electrification, external services, other building works, horticulture work, etc for this project and any other agencies simultaneously executing other works, the contractor shall leave necessary coordination facilities for same. The contractor shall leave such necessary holes, openings, etc for laying/burying in the work pipes, cables, conduits, clamps, boxes and hooks for fan clamps, etc as may be required for electric, sanitary, firefighting, telephone, CCTV system, etc and nothing extra over the agreement rates shall be paid for the same.
- 1.10 Unless otherwise specified in the bill of quantities the rates for all items of work shall be considered as inclusive of pumping out or bailing of water if required for which no extra payment will be made. This will include water encountered from any source such as rains, floods, subsoil water table being high, due to any other cause whatsoever.
- 1.11 Any cement slurry added over the base surface (or) for continuation of concreting for bond is added, its cost is deemed to have in built in the item unless otherwise explicitly stated nothing extra shall be payable or extra cement considered with consumption on this account. The rate for all the items in which the use of cement is involved is inclusive of charges for curing.
- 1.12 The contractor shall clear the site thoroughly of all the scaffolding materials and rubbish etc left out of his work and dress the site around the building to the satisfaction of the Engineer before the work is considered as complete.
- 1.13 Rates for plastering work shall include for making drip course wherever required and nothing extra shall be paid.
- 1.14 The rates quoted for all the brick/concrete work shall be deemed to include making openings, shallow cut, leave or form holes, recesses, chases etc and making good these with cement sand mortar (1:3)/PCC (1:2:4) or with the same

specifications as shown in drawings and /or as directed by the Engineer. No extra payment shall be made to the Contractor on this account.

- 1.15 Rates for all concrete works shall include for making drip course molding, grooves etc, wherever required and nothing extra shall be paid for the same.
- 1.16 The rates quoted by the tenderers shall deemed to be for the execution of works in accordance with the Construction Drawings supplied to the Contractor .
- 1.17 Where ever IS/BIS codes are mentioned in the Railway Specifications or in these specifications the latest codes with upto date amendments shall be used.

## **2.0 Field Materials Testing Laboratory.**

### **Testing of Materials.**

All materials used in the works shall be subject to inspection and tests. The contractor shall carry out, in the presence of engineer's representative/review consultant/client, sampling of such materials and making of concrete test cubes as and when ordered by the Engineer as per the appropriate Indian Standards and as directed by the Engineer. The contractor shall deliver the samples of materials and concrete test cubes to the office of the Engineer at site in a manner as directed by the Engineer who will inspect the same and then order for testing of the materials and concrete cubes.

The contractor shall arrange for testing of materials normally at the site of work but samples may be sent to outside testing laboratories, if necessary. The delivery of the samples shall be undertaken by the contractor. The cost and charges for sampling of materials and concrete cubes and delivering the same to the office of the Engineer and / or other places including all incidentals in connection with the same as directed by the Engineer and the testing charges thereof shall be borne by the contractor and shall be deemed to be included in the rates and prices quoted in the Bill Of Quantities. The results of the tests carried out shall be binding on the contractor who shall comply with any rectification measures that the Engineer may deem fit and order to be executed by the contractor as a result of testing.

- 2.1 The contractor shall provide a laboratory at his own cost for the testing of bricks, concrete cubes, concrete materials, soil and any other materials in accordance with the directions of the Engineer.
- 2.2 Whenever directed by the Engineer the contractor shall permit other contractors working for the Engineer on the Project to use field testing laboratory on payments as fixed by the Engineer such payment will be made directly by the other contractor using the laboratory.
- 2.3 The laboratory will be administered and staffed by the Engineer but the contractor shall provide the personnel commensurate with requirement at his own cost for attendance at the laboratory throughout the contract.

**2.4** The laboratory shall be equipped by the contractor at his own cost with one computer with necessary peripherals for maintaining the test records and all necessary apparatus to carry out the following tests in accordance with relevant Indian Standards or equivalent approved Standards.

**i) Cement Testing:**

Tests for fineness, strength, setting time and soundness in accordance with IS: 4031.

**ii) Concrete Testing:**

Tests for workability, proportions, density and strength in accordance with IS: 516 and 1199. In particular the cube testing machine shall be capable of exerting a slowly applied force up to 200 tonnes and the plates shall be suitable for crushing both 150 mm and 200 mm cubes. A vibrating table of suitable design shall be provided for compaction of cubes.

**iii) Aggregate Testing:**

In accordance with IS: 2386 (Part I to VIII) for the following tests on both fine and coarse aggregates.

**iv) Sieve analysis**

Determination of bulk density and voids on fine aggregates only.  
Determination of moisture content, specific gravity and absorption on coarse aggregates only. Determination of specific gravity and absorption.

**v) Bitumen Content test**

**2.5** The contractor shall, after getting approval from the Engineer print at his own cost all forms, tables, formats etc. required for recording test results etc.

**2.6** The laboratory shall be connected to the main water and electricity services. It shall also be supplied with portable gas equipment.

**2.7** On completion of the Defect Liability period the laboratory is to be dismantled and removed from site. The dismantled materials and equipment shall be the property of the contractor.

A quality Assurance Plan submitted by contractor shall be examined and approved by the Engineer. This plan shall be basically followed for inspection of work being carried out under the contract. This plan is for guidance and does not limit the scope of tests and inspection to be carried out by the Engineer or his representative to ensure execution of the work in terms of the contract.

# **Part-I**

# **Technical Specifications**

## **B. Electrical Works**



## **TECHNICAL SPECIFICATIONS**

### **Note:**

1. RDSO's specifications are priced document and can be purchased from RDSO.
2. Items which are not covered above should be as per BIS standards.

## **EXPLANATORY NOTES TO SCHEDULE OF PRICES FOR ELECTRICAL GENERAL SERVICES WORKS.**

### **GENERAL**

These explanatory notes are for guidance of field staff. Each work has its own particular requirements. Contractor shall be responsible for successful execution of work as per technical specifications.

- i. All electrical works should comply with Indian Electricity Act 2003 and Indian Electricity Rules 1956.
- ii. All electrical installations works shall conform to relevant Indian Standard Code of Practice and carried out as per relevant safety Code of Practices, Guide for Safety Procedures in Electrical Work as per I.S. 5216/Pt.I & II/1982(latest version) shall be observed.
- iii. All components used in installation shall be of appropriate ratings of voltage, current and frequency.
- iv. All minor items viz. hardware items, foundation bolts, termination lugs for electrical connections etc. as required and necessary for proper working of the equipment shall be deemed to have been included in the tender, whether such items are specifically mentioned in the tender documents or not.
- v. The work shall be carried out under the supervision of the DFCCIL Engineer.
- vi. The tenderer must inspect the site thoroughly before quoting rates, later on no claim shall be accepted.
- vii. The cost of LT Cable supplied by tenderer consumed during testing shall be borne by the Tenderer.

**SOR ITEMS SCHEDULE-C**

**SOR Item No.1b-i-** Laying of conduit shall be in conformity with IS 732/1989 (Latest Version), IS 4648/1968 (Latest Version).

Fittings for rigid steel conduit for electrical wiring shall conform to IS 2667/1988 (Latest Version) and accessories shall conform to IS 3837/1976 (Latest Version)

Fittings for rigid non-metallic conduit shall conform to IS 3419/1989(Latest Version) and accessories shall conform to relevant IS.

**SORItem No. 3 -** Provision of switch boxes in conformity with IS 732/1989 (Latest Version), IS 4648/1968 (Latest Version). Phenolic laminated sheet cover shall conform to relevant IS.

**SORItem No.4 -** Accessories shall be provided in conformity with IS 732/1989 (Latest Version), IS 4648/1968 (Latest Version).

**SORItem No.5 -** Lamp Holder shall conform to IS 1258/1987 (Latest Version) & ceiling rose shall conform to IS 371/1979 (Latest Version). Lamp Holder and ceiling rose shall be provided in conformity with IS 732/1989 (Latest Version), IS 4648/1968 (Latest Version).

**SORItem No.6–** Musical chime bell shall be installed in conformity with IS 732/1989 (Latest Version), IS 4648/1968 (Latest Version) & IS 8884/1978 (Latest Version). Musical chime bell shall conform to IS 2268/1968 (Latest Version)

**SORItem No.9 -** Meter Box shall be of size 500 mmx300 mmx135 mm fabricated with M.S.Sheet thickness not less than 1.2mm & shall be powder coated of approved colour . Meter Box shall conforming to IS 8623/ Pt1&3 /1993 (Latest Version) with degree of protection not less than IP42 as per IS 13947/1993(Latest Version). Meter Box shall be provided with sealing arrangements on right side , hinges on the left side and cable / conduit entry on top & bottom plates , approved meter fixing base,90x70mm front glass in enclosure for meter reading . Installation shall be in conformity to IS : 732/1989 (latest version ).Manufacturer shall have ISO 9001 certificate .

**SORItem no.10–** Fabrication of distribution box shall confirm to IS: 8623/Pt I & Pt III/1993(latest version) with degree of protection IP 53 and shall be installed in conformity with IS: 732/1989(latest version) and IS: 4648/1968(latest version).

**SORItem No.11 -** Drawing of GI Wire in existing pipe shall be in conformity with 732/1989 (Latest Version), IS 4648/1968 (Latest Version).

**SORItem No.12 -** Phenolic laminated sheet on junction box/fan box shall be installed in conformity with 732/1989 (Latest Version), IS 4648/1968 (Latest Version).

**SOR Item No.20** This item shall be in conformity to IS 3043/1987 (Latest Version). Excavation shall be done complying with Code of Safety as per IS 3764/1992 (latest version)

**SOR Item No.30(a) (i)** This item shall be in conformity to IS 5613/Pt.I Sec. 1 & 2/1985 (Latest Version). GI pipe shall conform to IS 1239/Pt.I/1990 and fittings shall conform to IS 1239/Pt.II/1992(latest version).

### **NON-SOR ITEMS SCHEDULE -D**

#### **ITEM NO. NS-1 to NS 6**

These items shall be in conformity to IS 1255/1983 (Latest Version) and laying & excavation shall be done complying with code of safety as per IS 3764/1992(latest version).

#### **ITEM no. NS-7**

**Item shall be ISI Mark and as per latest version.**

#### **ITEM no. NS-8**

### **T-5 LUMINARIES WITH ELECTRONIC BALLAST**

**SPECIFICATION No.** CEE/SPECIFICATION No CEE/NR/113/E/PS/2011

**SCOPE-** This specification covers the technical parameters of 28 w Florescent lamp box type fitting complete with electronic ballast suitable for Residential Quarters and Service Buildings.

#### **SPECIFICATION-**

Energy Efficient tubular florescent light fitting T-5, 1 x 28 W (box type) complete with electronic ballast, pre – wired up to the terminal block with single stranded PVC insulated copper conductor and all accessories. Ballast shall be Flicker free instant high frequency electronic ballast for 1 x 28 W T-5 lamp, rated voltage 240 V 50 Hz AC, 0.14 A(max) rated current, wide operating range to withstand at least 180 -265 V Ac supply. Power consumption of ballast shall be as low as possible and shall not exceed 4.5 watt and its power factor shall be 0.95 or more and THD shall be less than 33 %. The channel is made of pre treated CRCA MS with epoxy white powder coated finish. The fitting shall be suitable for mounting on wall, ceiling as well as suspension. Over all

technical specification confirming to IS 10322/Part-V/Section-I or latest amendment and shall be similar to following models.

OSRAM	4008321384454
PHILIPS	TMS 122/128W HF
BAJAJ	BT IR 128 RDSO
C & S	LTIC 101HFD1/RL(1x 28 W T-5)

**Specification of Lamp-** 28 W/Tubular Florescent, double capped (T-5) lamp with G-5 Caps, initial lumens (min) 2400, colour temperature (min) 4000 K, CRI(min) 80 suitable for operation on 230 V 50 Hz single phase AC supply.

### **ITEM NO. NS-9 &10**

#### LT FEEDER PILLAR

- (a) The work includes design, manufacture, and supply, erection, testing and commissioning of outdoor type feeder pillar suitable for 415 volts 3 phase 4 wire 50 Hz AC supply system.
- (b) The feeder pillar shall be out door type and to be installed and commissioned on floor/ground as per IE Rules and as per site and the feeder pillar shall be fabricated from 12 SWG MS sheet and angle iron of size 65x65x8mm thick conforming to IS 8623/1993/Pt. I to Pt.III (Latest Version). It should be painted of approved colour after two coats of red oxide primer .
- (c) The aluminum bus bar for phases and neutral are to be provided. The aluminum bus bar shall be properly placed on DMC insulator. The gap between the bus bar shall be adequate and as per IE Rules. The bus bar should be of high conductivity aluminum suitable for electrical purposes and of uniform cross section. The bus bar shall be suitable insulated with epoxy coating to with-stand test voltage of 2.5 KV.
- (d) The feeder pillar shall be capable for housing items as per schedule of rates and quantities.

Fuses and Fuse bases shall be conformed to IS.13703/1993 (Latest Version)

The interlinking of incoming to bus bar and from bus bar to outgoing shall be of aluminum strip of suitable size and length.

The cubical box shall be robust in construction and fabricated out of heavy gauge sheet steel of thickness not less than 12 SWG hinged door should be provided on front and rear to enable installation and inspection of cable connection and other equipments mounted in inside it. The canopy shall be given necessary slope for rainwater to flow away. Frame of feeder pillar 300mm. Height from foundation covered with removable 12 SWG MS sheet on all sides.

The canopy should be projected over the sides and doors. Its sides are lower than the top of side sectional of the shell. The side sections are feigned to 'U' form for water draining. Adequate ventilation as in back can be opened and locked by a special key and visual indication of lock and latch in open and outside. The jointing of cable and connections can be carried out at the back and front from bottom and as required, inspection removal/replacement of fuses can be carried out easily.

In addition of GI Pad locks (One in front and other in back) should be welded in the shutter and will be locked position by fixing its make position in the eye fixed in the other side.

- (e) Provision of double earthing of cubical shall be made by means of hot dipped galvanized bolts, nuts & washers of 38x12mm. (Dia) on either side of the apron at suitable places. All the metallic frame of mounting provided in side the feeder pillar shall be earthed with GI strip of suitable size.
- (f) Proper size glands should be provided for cable entry.
- (g) A Danger plate conforming to IS: 2551(latest version) shall be affixed on front door and back door.
- (h) The built in locking arrangement comprising of round bars should be provided as done in steel almirah along with handle. (Godrej type locking.)
- (i) Separate handle for each sizes of fuses/grips removal base shall have to be supplied along with each feeder pillar.**
- (j) All the cable connections shall be done with proper size of aluminium Lugs and armoured of the cable shall be earthed with the gland for continuous earthing purpose of the feeder pillar.**

**ITEM NO. NS – 11**

**VARIOUS SIZES FRLS PVC INSULATED COPPER CONDUCTOR WIRING CABLES**

Fire Retardant Low Smoke (FRLS) PVC insulated multi stranded unsheathed copper conductor wiring cable for working voltage up to & including 1100 Volts, ISI marked conforming to IS 694/1990 (Latest Version).Wiring of installations shall be in conformity with IS 732/1989 (Latest Version), IS 4648/1968 (Latest Version)

**DRAWING OF VARIOUS SIZES PVC INSULATED COPPER CONDUCTOR WIRING CABLES**

Wiring of installations shall be in conformity with IS: 732/1989(latest version) and IS: 4648/1968(latest version).

**ITEM NO. NS-12**

**4x14 WATT ENERGY EFFICIENT T-5 STREET LIGHT FITTING**

The 4x14 watt Energy efficient T5 Street light fitting shall be supplied as per Bajaj model no 530705BTSLF414 FRP / C&S Model no T5SHE414 / SURYA model no SUL 414 T5 AL DD EB2/P2 complete with T-5 Lamp and other accessories including supply of ISI marked 2x2.5 sq mm PVC insulated multi strand copper conductor cable and connection with fitting to junction box of pole.

**ITEM NO. NS 13**

**HOT DIP GALVANIZED OCTAGONAL POLE**

**1. Design**

The Octagonal Poles shall be designed to withstand the maximum wind speed of 169 KM/Hr. The top loading i.e. area and the weight of fixtures are to be considered to calculate maximum deflection of the pole and the same shall meet the requirement of BS: 5649 Part VI 1982(latest version) and the Octagonal Poles shall be in single section. There shall not be any circumferential weld joint. The octagonal pole shall be supplied as per Crompton Greaves Cat. Ref. No. HM 110 4P/ HM 110 5P/ HM 110 9PA respectively or similar type of approved make.

**2. Pole Shaft**

The pole shaft shall have octagonal cross section and shall be continuously tapered with single longitudinal welding. There shall not be any circumferential welding. The welding of pole shaft shall be done by Submerged Arc Welding (SAW) process.

All octagonal pole shafts shall be provided with the rigid flange plate of suitable thickness with provision for fixing 4 Nos. foundation bolts of size not less than 16 mm dia 80 mm long or as recommended by the manufacturer. The Octagonal Poles shall be bolted at foundation. This base plate shall be fillet welded to the pole shaft at two locations i.e. from inside and outside. The welding shall be done as per qualified MMAW process.

### 3. Door Opening

The octagonal Poles shall have door of approximate 500 mm length at the elevation of 500 mm from the Base Plate. The door shall be vandal resistance and shall be weather proof to ensure safety of inside connections. The door shall be flush with the exterior surface and shall have suitable locking arrangement. There shall also be suitable arrangement for the purpose of earthing.

The pole shall be adequately strengthened at the location of the door to compensate for the loss in section.

Smart pack junction box with one No. single pole 6 A. MCB for single arm pole & 2 Nos.for double arm pole 6 A MCB. and two / four terminals as per drawing approved by DFCCIL..

### 4. Top Mountings

The galvanized mounting single/double arm 300 mm long bracket as required shall be supplied along with the Octagonal Poles for installation of 150W Street Light MH luminaire at pole as per drawing approved by Railway.

### 5. Manufacturing

The manufacturing unit shall be ISO 9001:2000 & ISO 14001 certified to ensure consistent quality & environmental protection.

### 6. Material

- i.Octagonal Poles - Conforming to grade S355JO
- ii.Base Plate - FC 410 conforming to IS 226/IS 2062(latest version)
- iii.Foundation Bolts - 5.8 Gr. As per IS 1367(latest version)
- iv.Galvanization - The poles shall be hot dip galvanized as per IS 2629/ IS 2633/ IS 4759(latest version) standards with average coating thickness not less than 65 micron. The galvanizing shall be done in single dipping.

**Note: The original manufacturer certificate for Hot Dip Galvanized Octagonal Pole and accessories should be provided at the time of inspection.**

**ITEM NO. NS-14**

**INSTALATION OF AC CEILING FAN**

Ceiling Fan shall be installed in conforming with IS 732/1989 (Latest Version) IS 4648/1968 (Latest Version).The clamp should be made as per site requirement and drawing approved by DFCCILwith suitable nut bolt & washer.

**ROTARY STEP FAN REGULATOR**

Rotary step Fan Regulator of socket size shall be as per Anchor make Cod No. 52369 Delux/SSK make Code No. TL-7041/North Wets make Cat No. M1900 and shall be provided in conformity with IS 732/1989 ( Latest version ) IS 4648/1968 (Latest version).

**ITEM NO. NS-15**

**BULK HEAD LUMINAIRE FOR CFL**

The luminaire should be die cast aluminium body finished in stove enamel hammertone grey/ powder coated and fitted with a heat resistant glass cover through weather proof gasket. A CFL holder is fitted inside the luminaire. An electro galvanised MS wire guard assembly is hinged to body for ease of maintenance. The CFL bulk head is prewired with vacuum pressure impregnated copper would ballast

**ITEM NO. NS-16**

**IN BUILT ELECTRONIC BALLAST HOUSED CFL**

**11 W** in built electronic ballast housed with BC cap compact and single ended fluorescent lamp (CFL) 2/3 **U** shape should be approved make and suitable for 240 V 50 HZ AC supply .This CFL should be provided in already fixed batten holder.

**ITEM NO. NS-17 (a)& (b)**

**Double door MCB Distribution Board**

- i) Wall/pillar mounted/recessed type cubical type Distribution Board shall be pre-fabricated conforming to IS 8623/1993 Part I to III ( Latest Version) with degree of protection IP 42 of approved make. The boards shall be suitable to work on 415 Volts 250 Volts Single /three phase AC supply system as required.
- ii) The MCBs shall be 10 KA Breaking Capacity C Series and conforming to IS 8828/1996 ( latest version )
- iii ) Installation of distribution board shall be conformed to IS 732/1989 ( Latest version) 4648/1968 (latest version)



# **PART-I**

## **Chapter V**

# **DRAWINGS**

DFCC /UMB

UTILITY SHIFTING-HR

---

<b>S.NO.</b>	<b>Description</b>	<b>Drawing No.</b>
1.	GAD of Type-II Quaters	DCW/CE/R/17/82
2.	GAD of Type-III Quaters	DCW/CE/R/18/82
3.	GAD of Station Building	P-386/DYCE/C/UMB/12

Note: The above drawings are indicative. The work shall be done as per final drawings issued by DFCCIL and payment shall be done as per quantities of works executed as per applicable accepted rates.

GROUND FLOOR PLAN

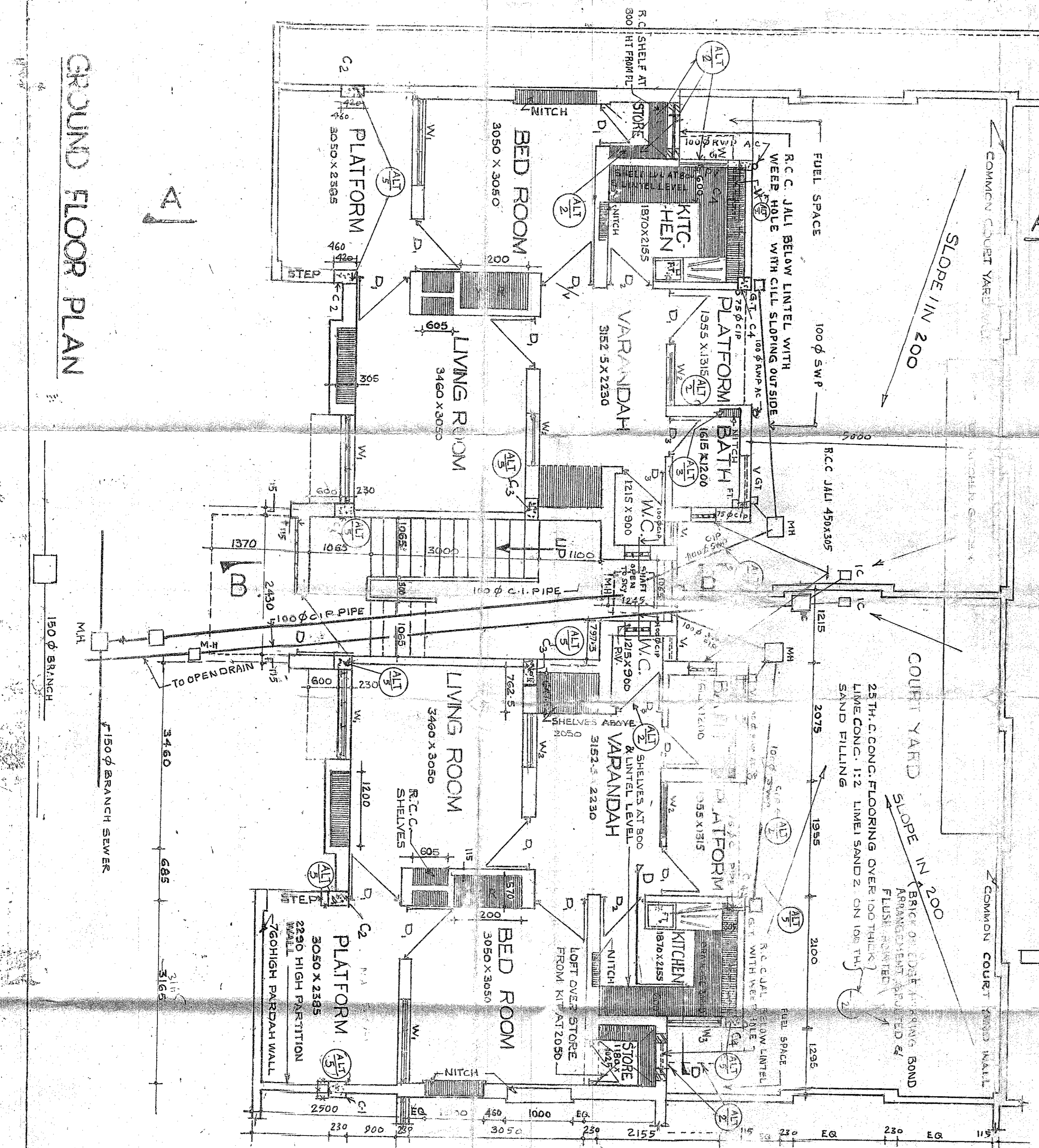

FRONT ELEVATION

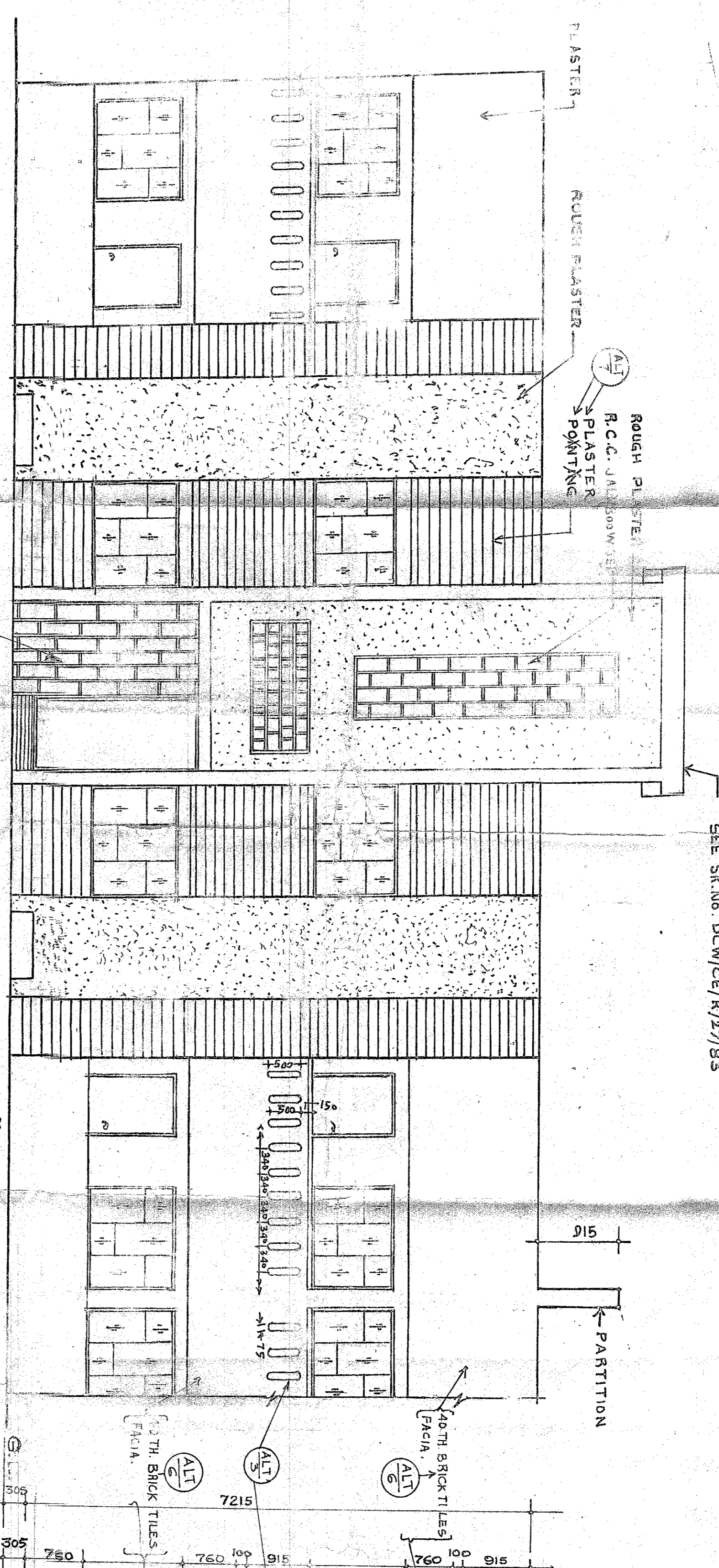

FIRST FLOOR PLAN

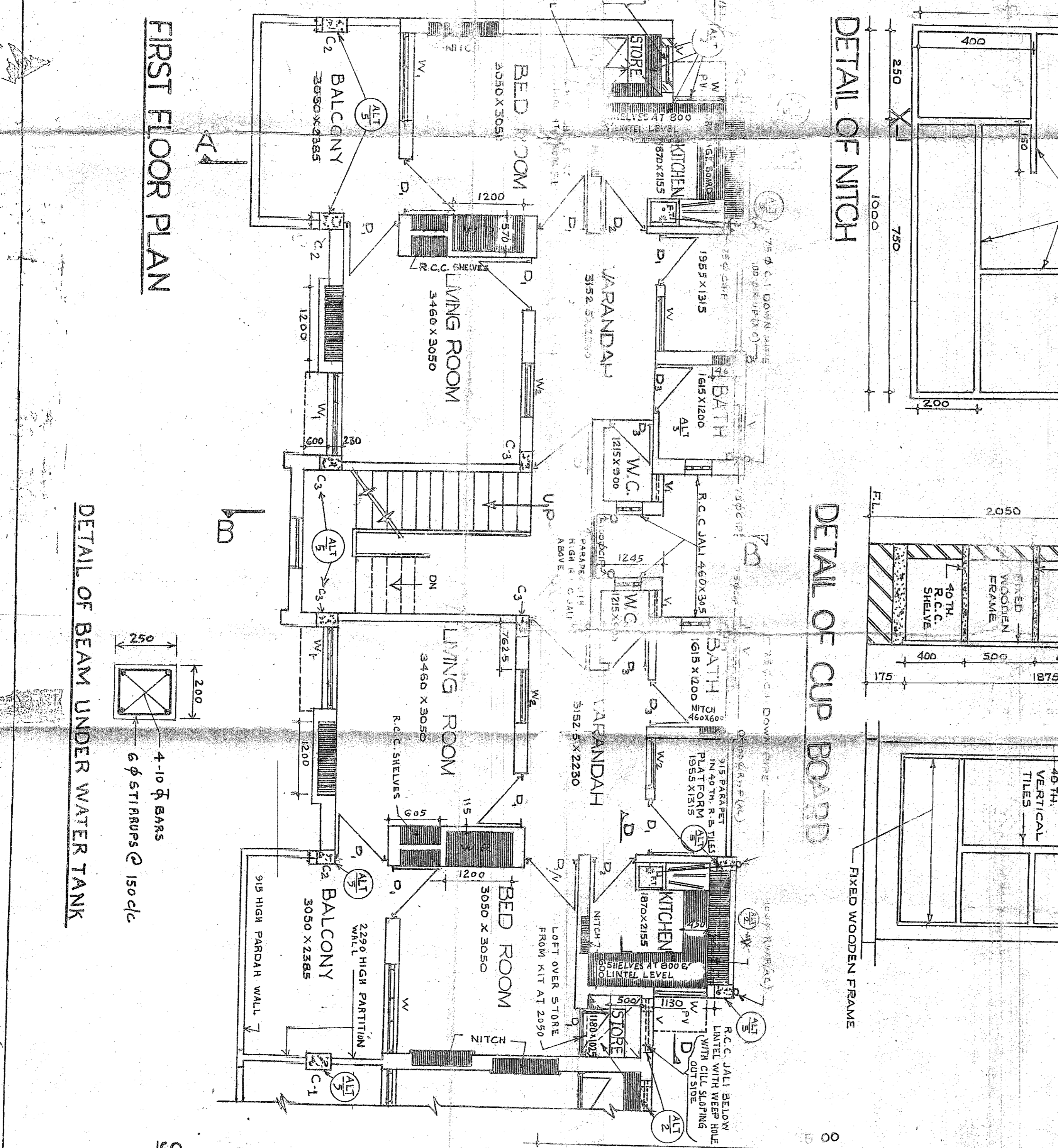

DETAIL OF BEAM UNDER WATER TANK

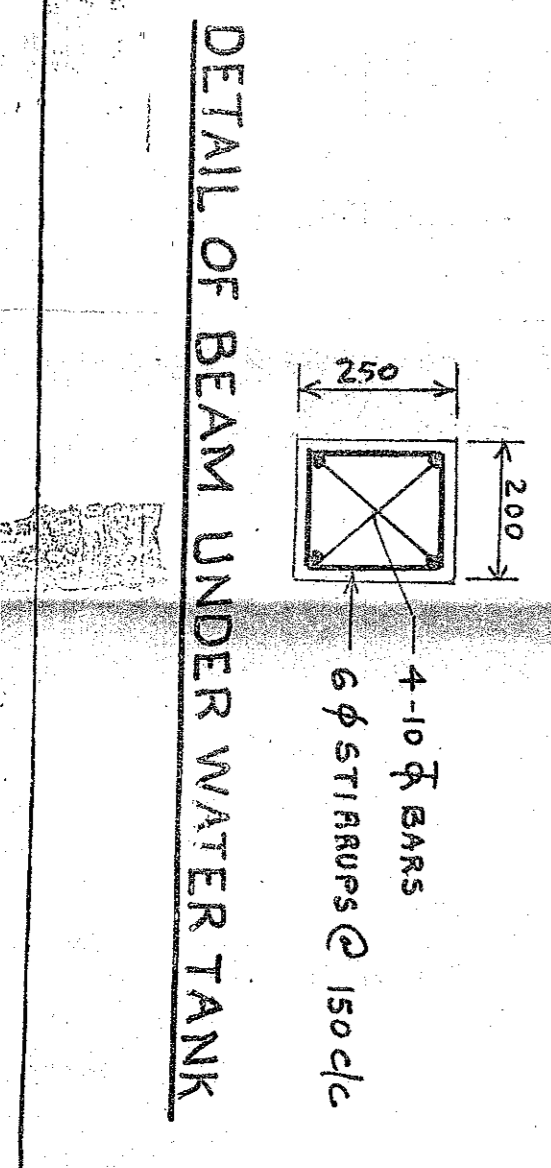

SECTION AT X X

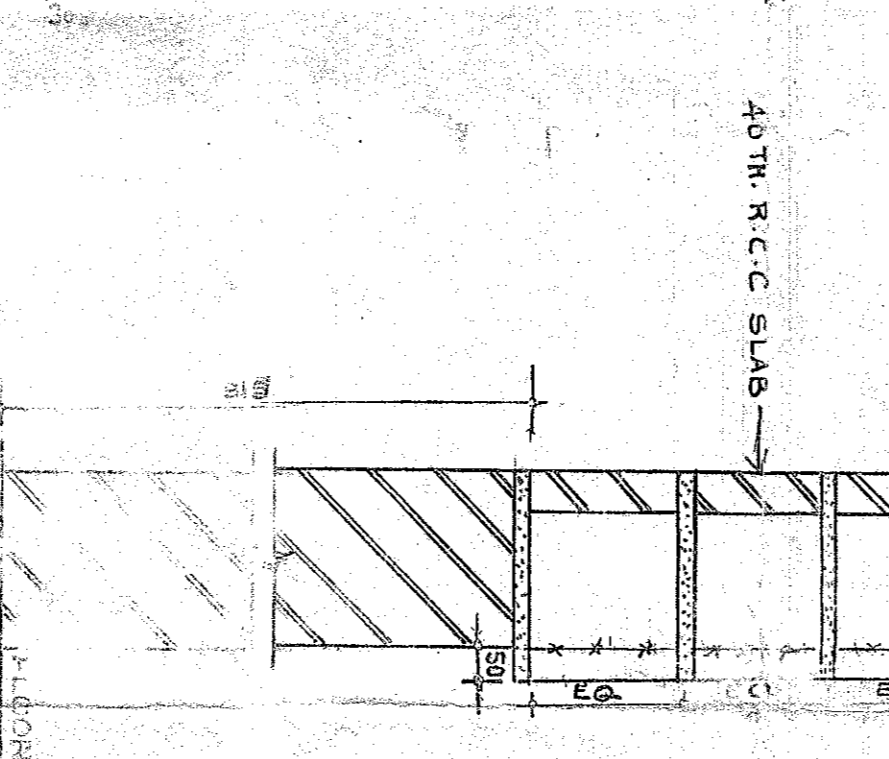

DETAIL OF NITCH

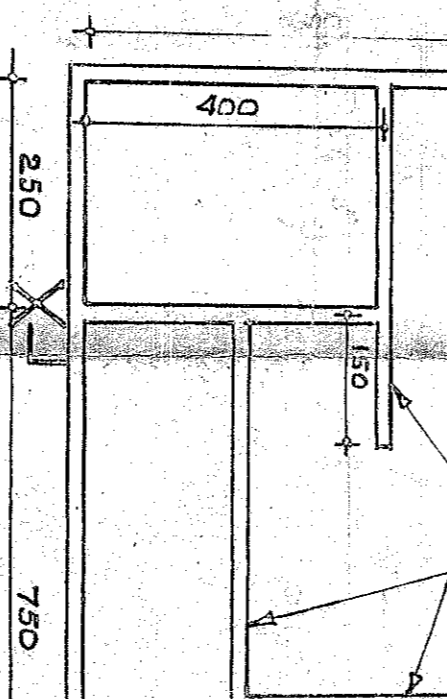

DETAIL OF CUP BOARD

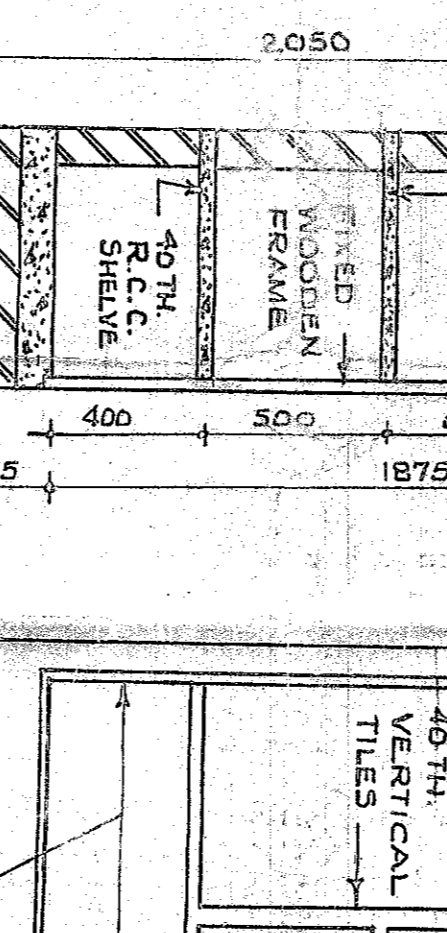

SECTION AT A A

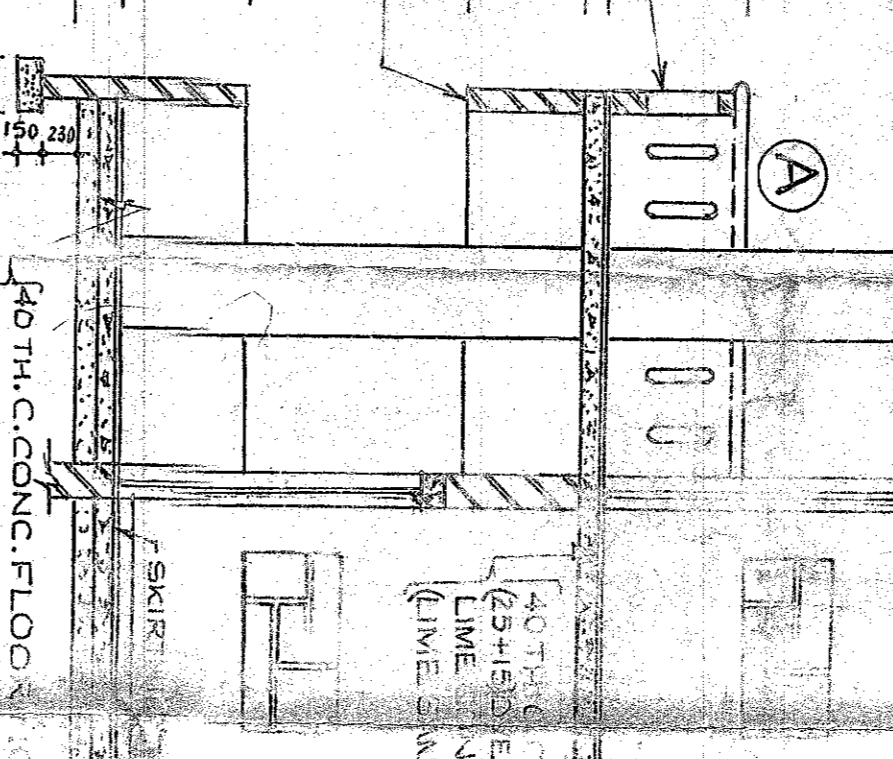

SECTION AT B B

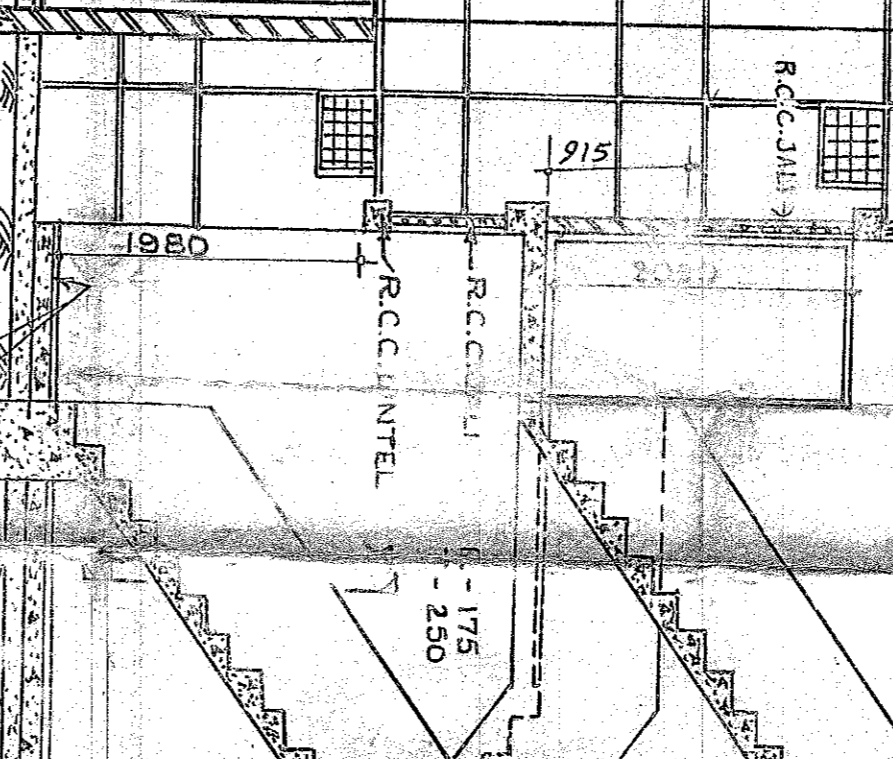

SECTION AT D D

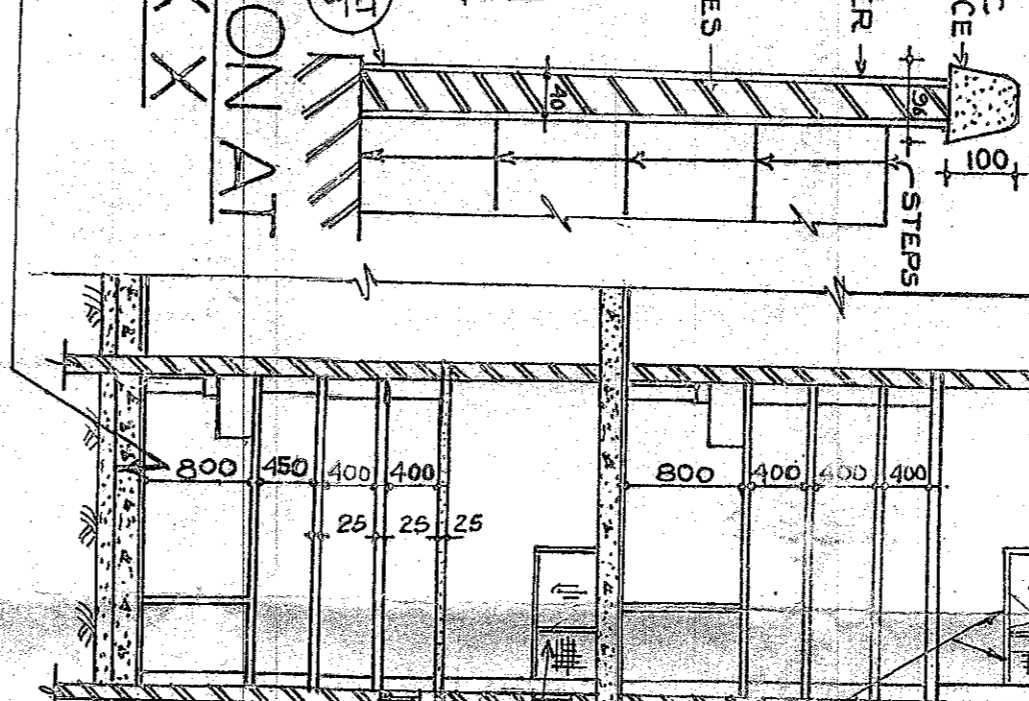

SECTION FRONT AT A A ELEVATION

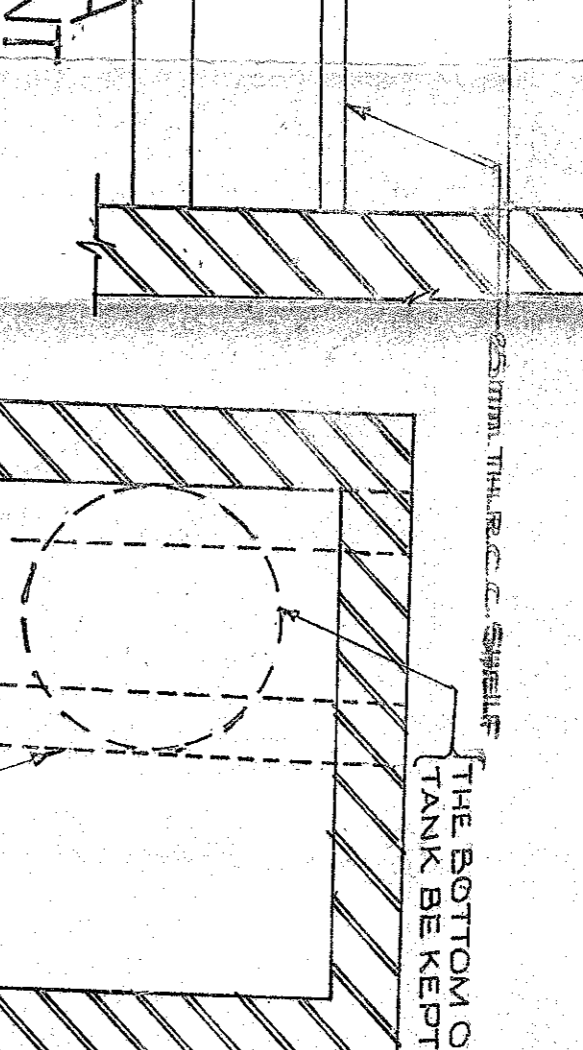

SECTION AT X X

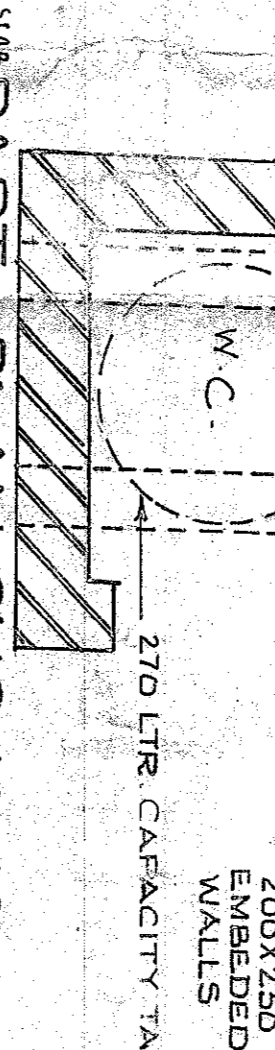

SECTION OF 230 TH WALL

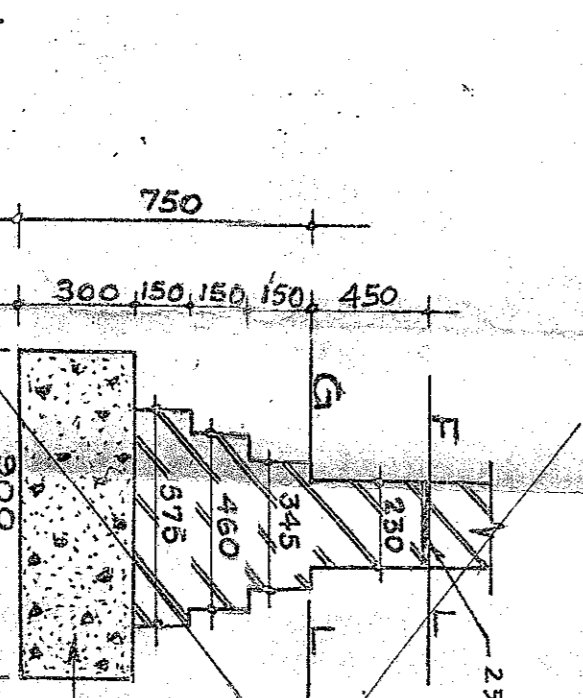

SECTION OF 115 TH WALL

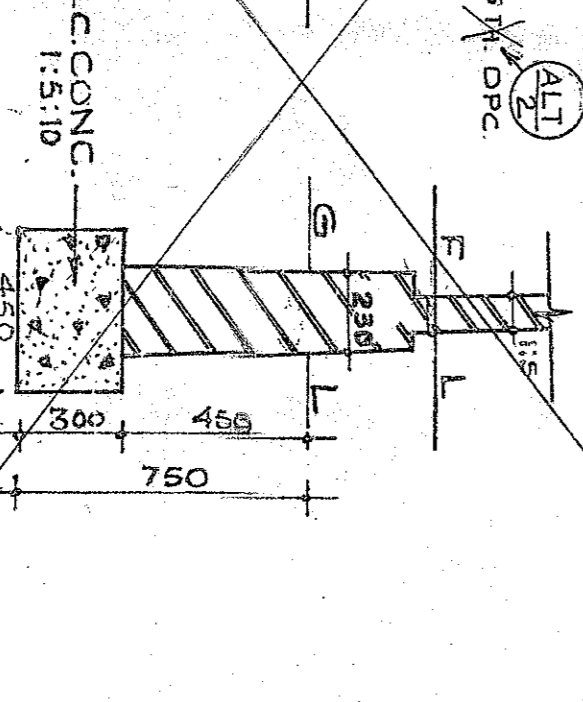

SECTION OF 230 TH WALL (FOR DOUBLE STOREY)

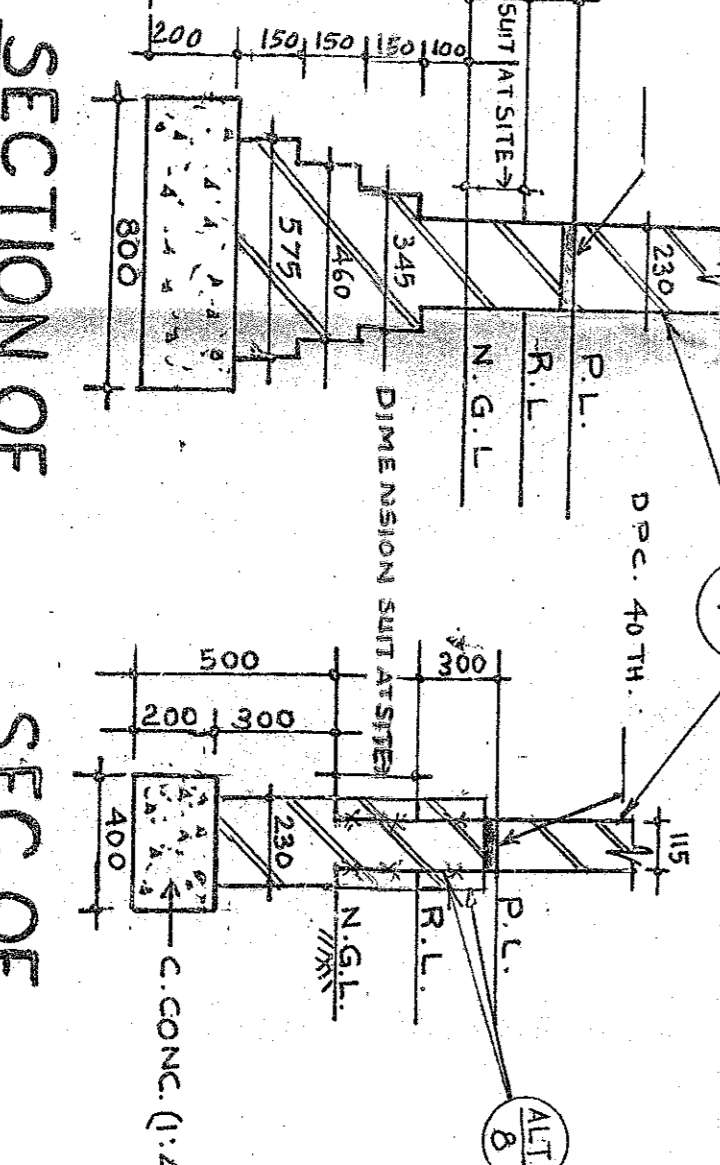

SEC OF 115 TH WALL (FOR DOUBLE STOREY)

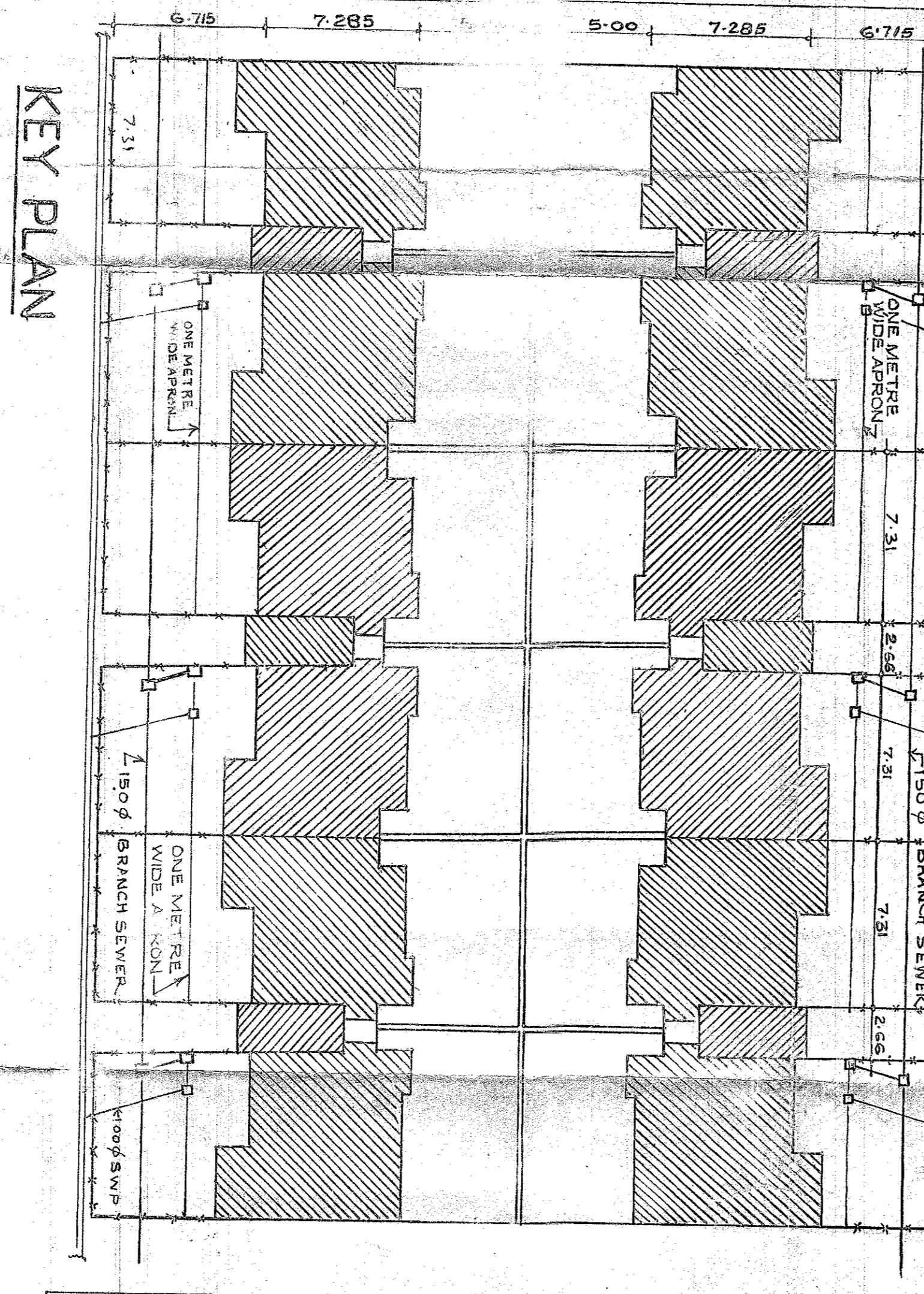
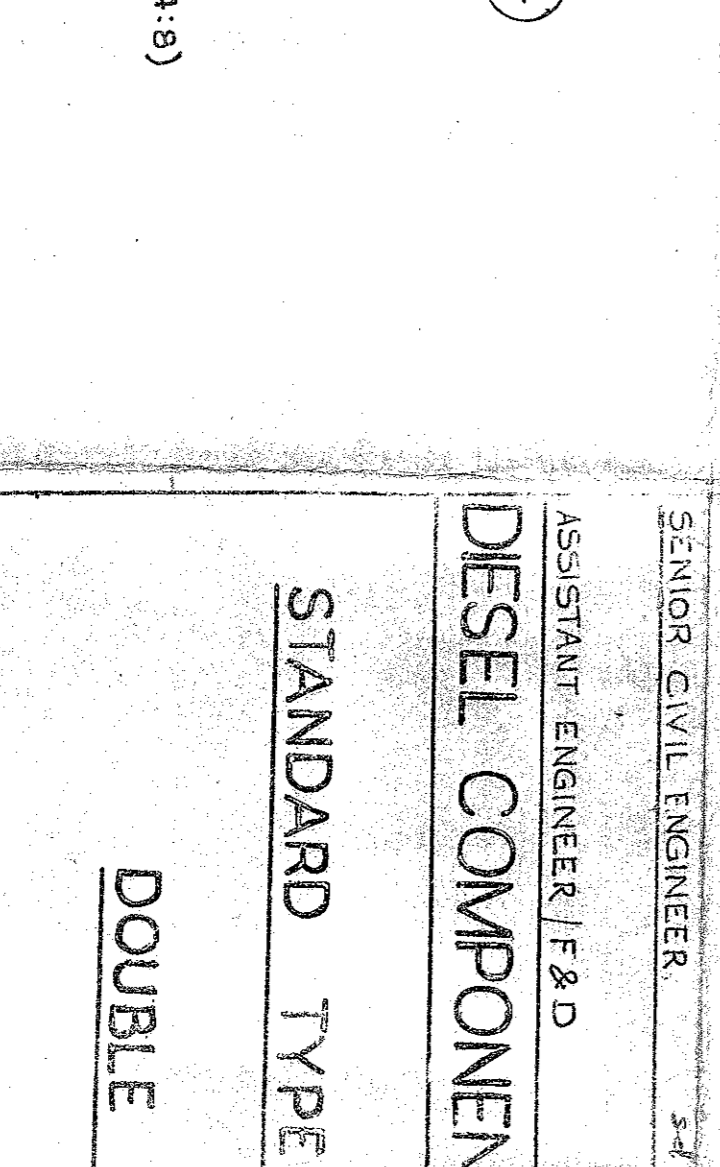

**SCHEDULE OF DOORS & WINDOWS**

NO.	DESCRIPTION	QUANTITY	REMARKS
1	1.000	1	WOODEN DOOR WITH GLASS PANEL
2	2.000	2	WOODEN WINDOW WITH GLASS PANEL
3	3.000	3	WOODEN WINDOW WITH GLASS PANEL
4	4.000	4	WOODEN WINDOW WITH GLASS PANEL
5	5.000	5	WOODEN WINDOW WITH GLASS PANEL
6	6.000	6	WOODEN WINDOW WITH GLASS PANEL
7	7.000	7	WOODEN WINDOW WITH GLASS PANEL
8	8.000	8	WOODEN WINDOW WITH GLASS PANEL
9	9.000	9	WOODEN WINDOW WITH GLASS PANEL
10	10.000	10	WOODEN WINDOW WITH GLASS PANEL
11	11.000	11	WOODEN WINDOW WITH GLASS PANEL
12	12.000	12	WOODEN WINDOW WITH GLASS PANEL
13	13.000	13	WOODEN WINDOW WITH GLASS PANEL
14	14.000	14	WOODEN WINDOW WITH GLASS PANEL
15	15.000	15	WOODEN WINDOW WITH GLASS PANEL
16	16.000	16	WOODEN WINDOW WITH GLASS PANEL
17	17.000	17	WOODEN WINDOW WITH GLASS PANEL
18	18.000	18	WOODEN WINDOW WITH GLASS PANEL
19	19.000	19	WOODEN WINDOW WITH GLASS PANEL
20	20.000	20	WOODEN WINDOW WITH GLASS PANEL

- FOUNDATION OF THE WALLS TO BE CONCRETE ON SAND.
- IN ELEVATION PLASTER TO BE 12.5 CM CONCRETE ON SAND.
- INTERIOR FINISH TO BE WHITE WASH.
- WOODEN DOORS AND WINDOWS TO BE 45 MM THICK.
- WOODEN DOORS AND WINDOWS TO BE 45 MM THICK.
- WOODEN DOORS AND WINDOWS TO BE 45 MM THICK.
- WOODEN DOORS AND WINDOWS TO BE 45 MM THICK.
- WOODEN DOORS AND WINDOWS TO BE 45 MM THICK.
- WOODEN DOORS AND WINDOWS TO BE 45 MM THICK.
- WOODEN DOORS AND WINDOWS TO BE 45 MM THICK.
- WOODEN DOORS AND WINDOWS TO BE 45 MM THICK.
- WOODEN DOORS AND WINDOWS TO BE 45 MM THICK.
- WOODEN DOORS AND WINDOWS TO BE 45 MM THICK.
- WOODEN DOORS AND WINDOWS TO BE 45 MM THICK.
- WOODEN DOORS AND WINDOWS TO BE 45 MM THICK.

**TRUE COPY**

BY CHIEF ENGINEER

SENIOR CIVIL ENGINEER

ASSISTANT ENGINEER I & II

DESEL COMPONENT WORKS PTA

STANDARD TYPE II QUARTERS

DOUBLE STOREY

SCALE: 1:150

DATE: 15/11/70

D. V. S. ARCHITECTS

NOTE

1. ALL DIMENSIONS ARE IN METERS UNLESS OTHERWISE SPECIFIED.
2. FINISHES ARE AS SHOWN IN THE FINISH SCHEDULE.
3. ALL WORK IS TO BE DONE IN ACCORDANCE WITH THE SPECIFICATIONS AND STANDARDS OF THE GOVERNMENT OF INDIA.
4. THE CONTRACTOR SHALL BE RESPONSIBLE FOR OBTAINING ALL NECESSARY PERMITS AND APPROVALS FROM THE LOCAL AUTHORITIES.
5. THE CONTRACTOR SHALL BE RESPONSIBLE FOR THE PROTECTION OF ALL EXISTING UTILITIES AND STRUCTURES.
6. THE CONTRACTOR SHALL BE RESPONSIBLE FOR THE PROTECTION OF ALL EXISTING TREES AND LANDSCAPE.
7. THE CONTRACTOR SHALL BE RESPONSIBLE FOR THE PROTECTION OF ALL EXISTING SERVICES.
8. THE CONTRACTOR SHALL BE RESPONSIBLE FOR THE PROTECTION OF ALL EXISTING STRUCTURES.
9. THE CONTRACTOR SHALL BE RESPONSIBLE FOR THE PROTECTION OF ALL EXISTING UTILITIES.
10. THE CONTRACTOR SHALL BE RESPONSIBLE FOR THE PROTECTION OF ALL EXISTING SERVICES.

**WITH HOLLOW BLOCK**

ALL WALLS TO BE CONSTRUCTED WITH HOLLOW BLOCKS OF 400mm x 200mm x 100mm. ALL WALLS TO BE FINISHED WITH PLASTER AND PAINT.

**PLINTH AREA 56.70 SQM**

**STANDARD TYPE III QUARTERS**

**DOUBLE STOREY**

SCALE: 1/5, 1/28, 1/11

PLAN NO. DC/ICE/R/18/82 ALT 3

TRUE COPY

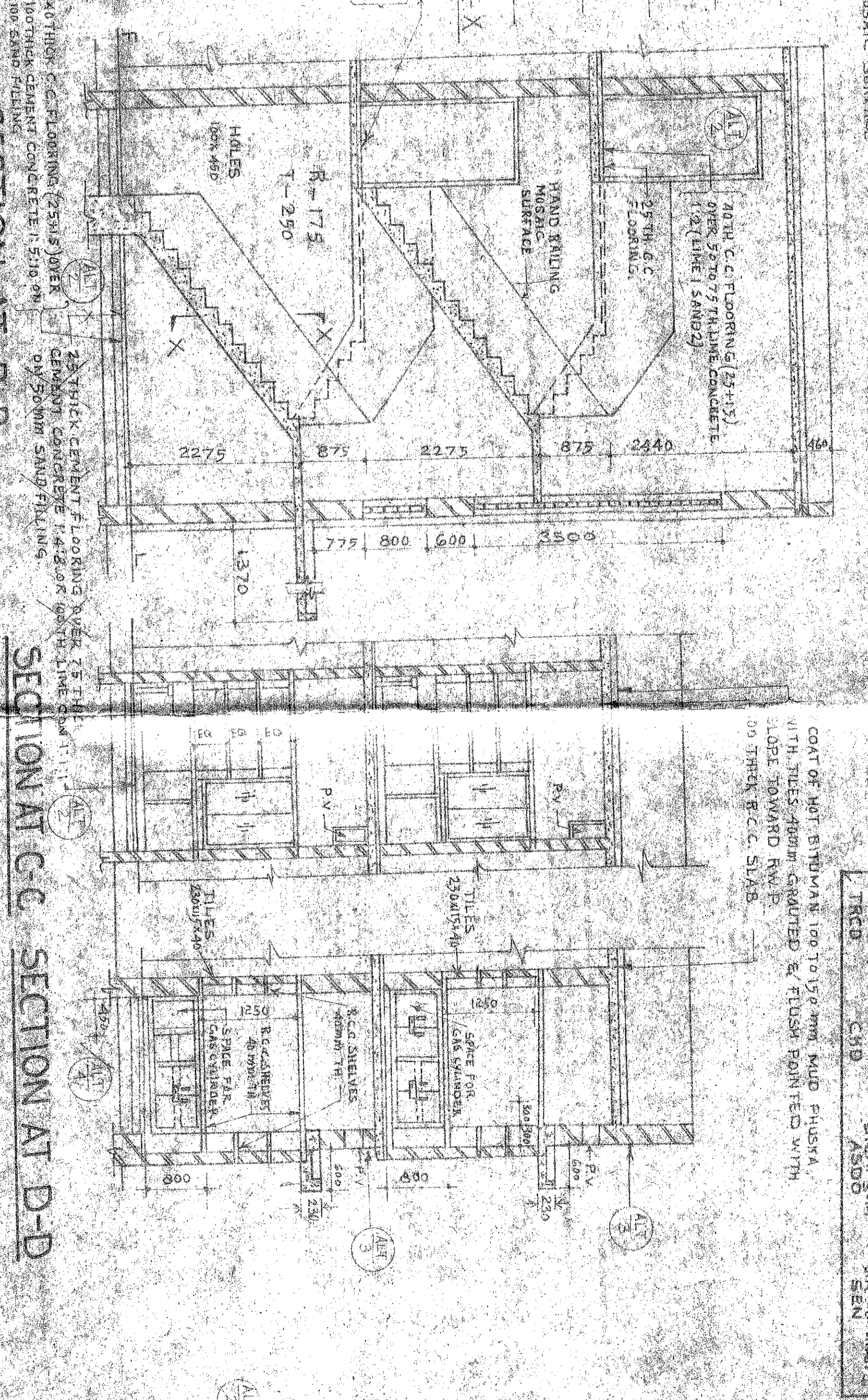

SECTION A-A

SECTION B-B

SECTION C-C

SECTION D-D

**SCHEDULE OF DOORS & WINDOWS**

NO.	DESCRIPTION	QTY	UNIT	REMARKS
1	WOODEN DOOR WITH GLASS PANEL	10	NO.	
2	WOODEN WINDOW WITH GLASS PANEL	20	NO.	
3	WOODEN WINDOW WITH GLASS PANEL	15	NO.	
4	WOODEN WINDOW WITH GLASS PANEL	10	NO.	
5	WOODEN WINDOW WITH GLASS PANEL	5	NO.	
6	WOODEN WINDOW WITH GLASS PANEL	5	NO.	
7	WOODEN WINDOW WITH GLASS PANEL	5	NO.	
8	WOODEN WINDOW WITH GLASS PANEL	5	NO.	
9	WOODEN WINDOW WITH GLASS PANEL	5	NO.	
10	WOODEN WINDOW WITH GLASS PANEL	5	NO.	

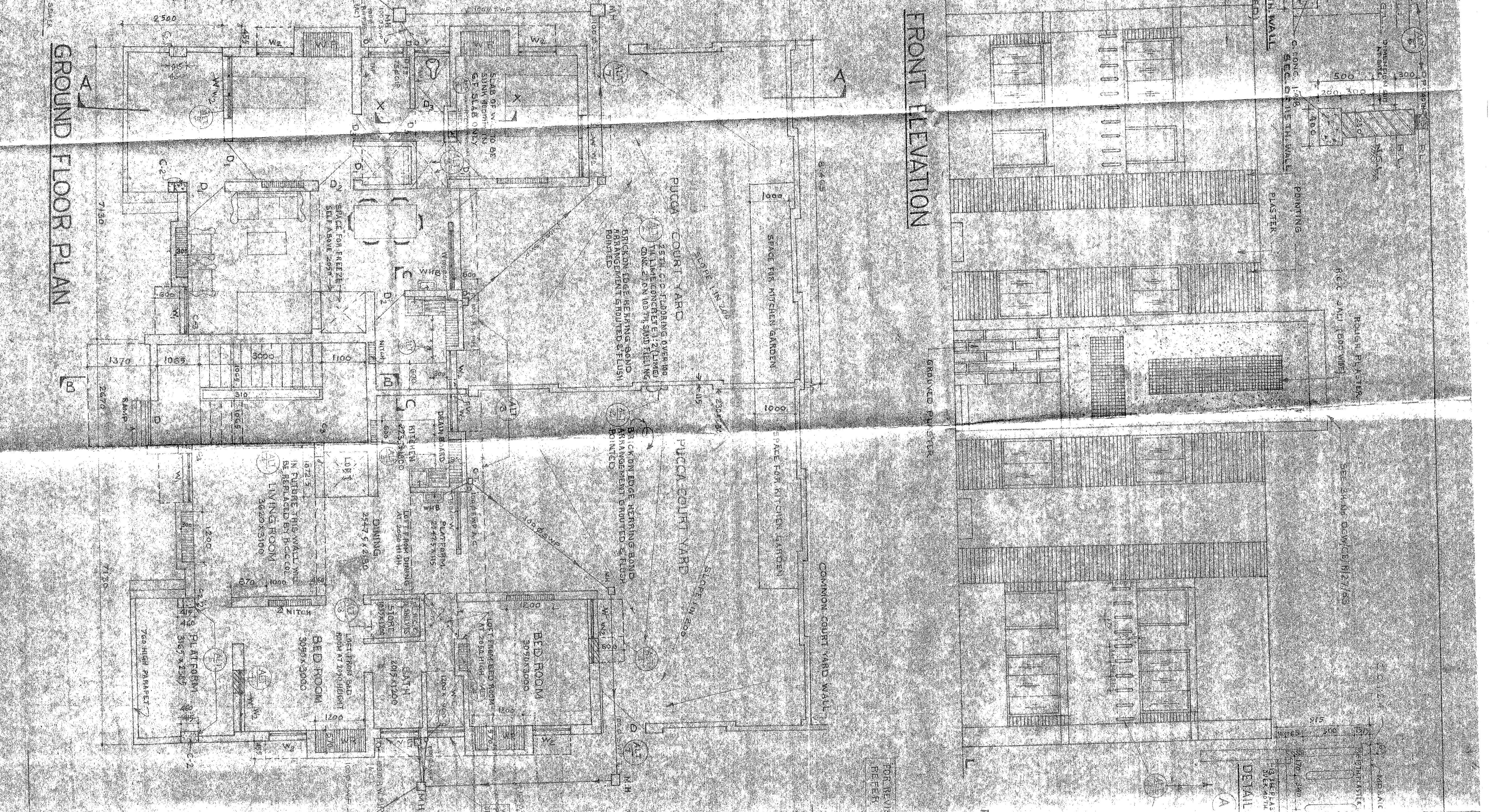
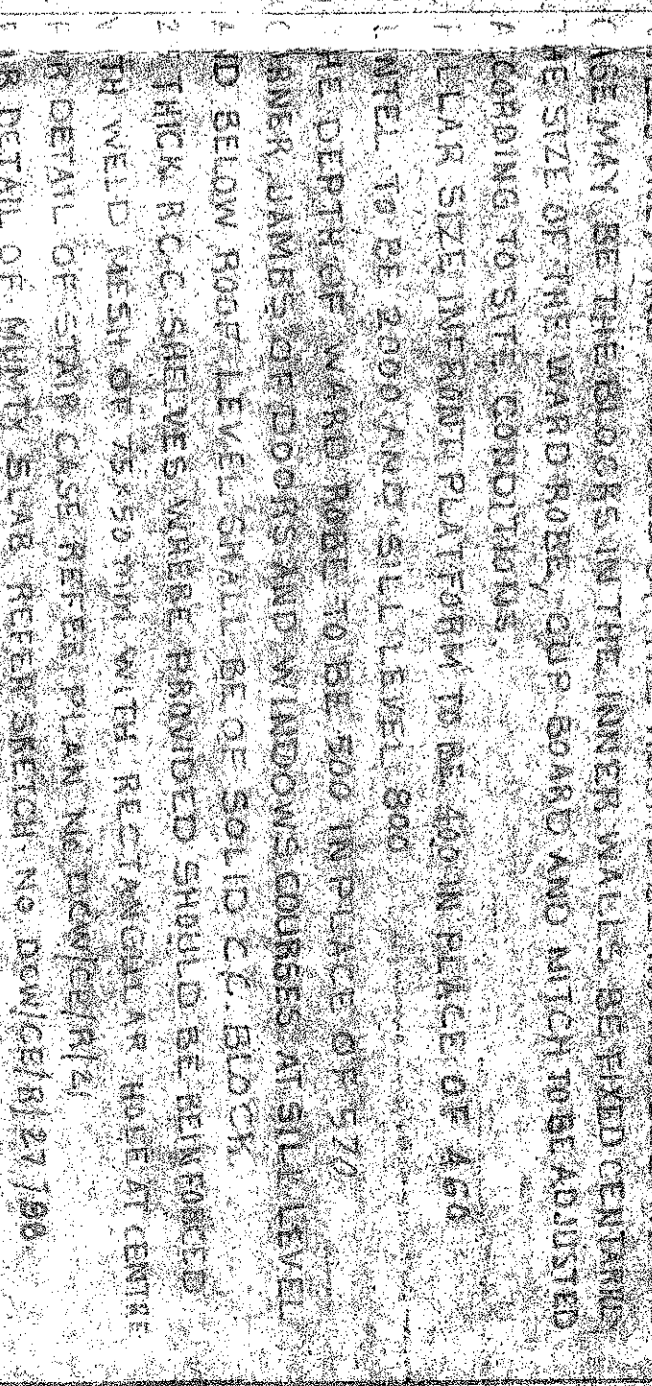
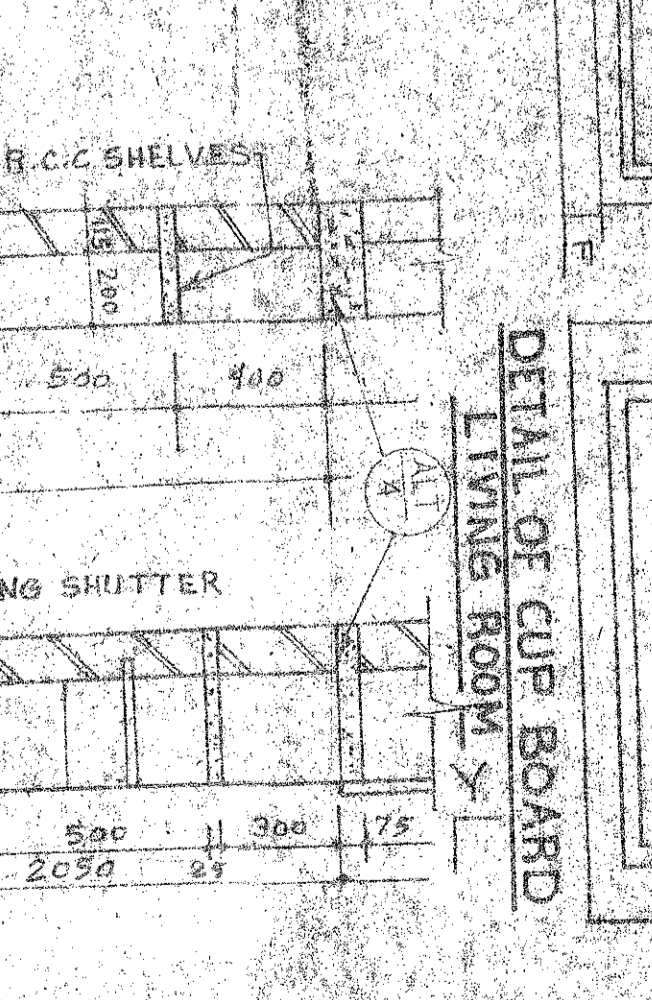
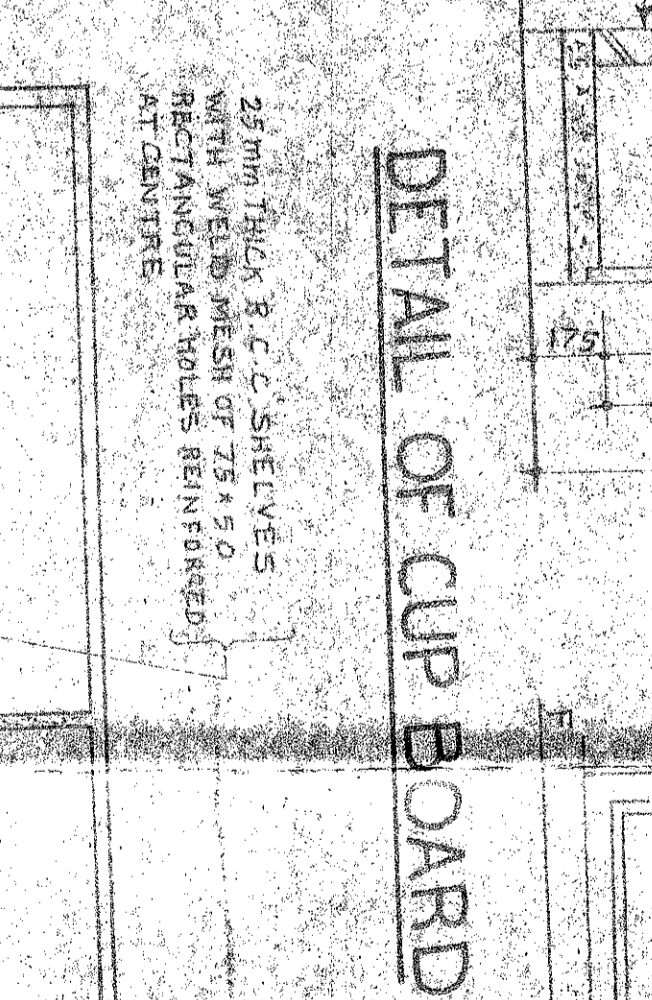
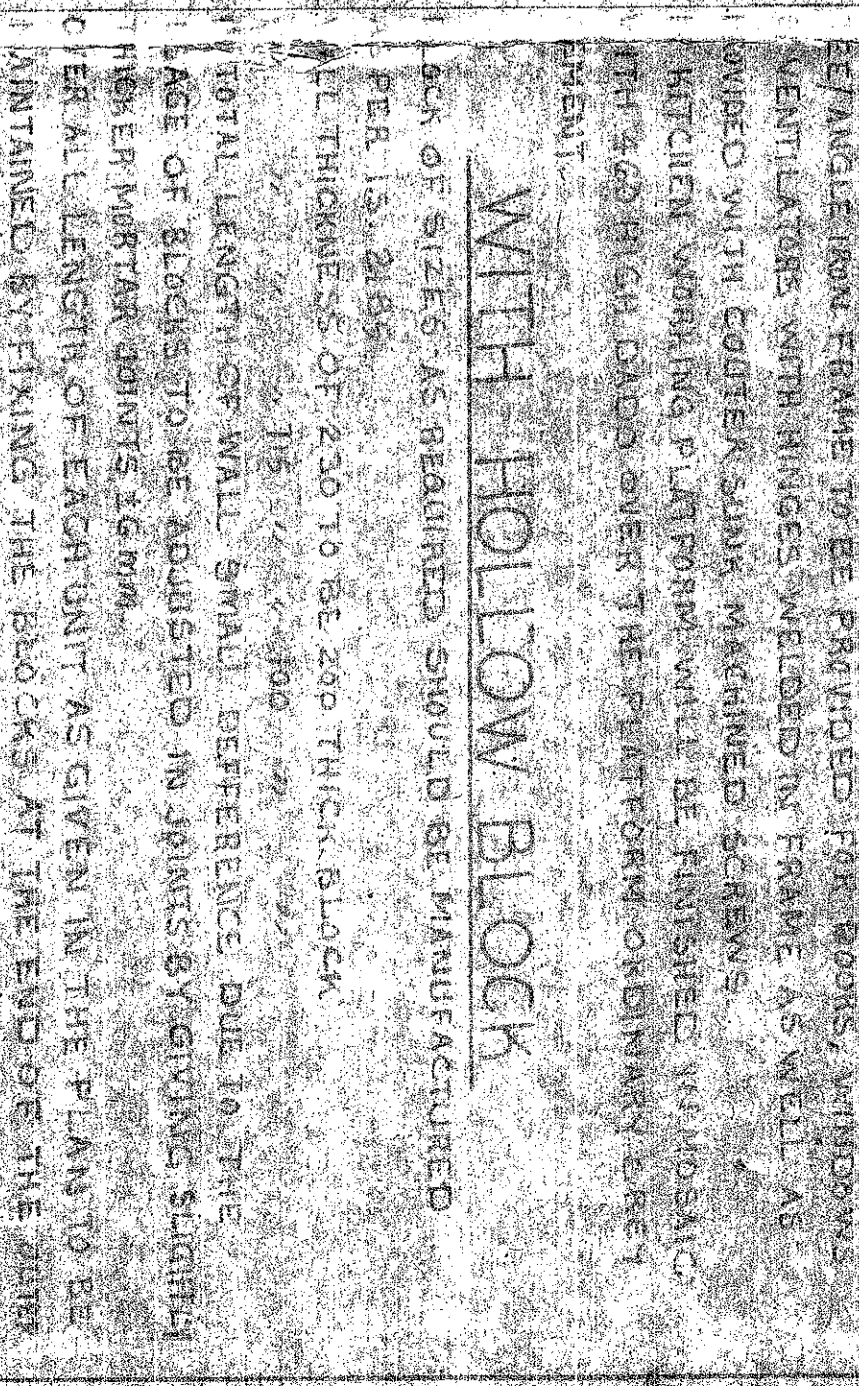
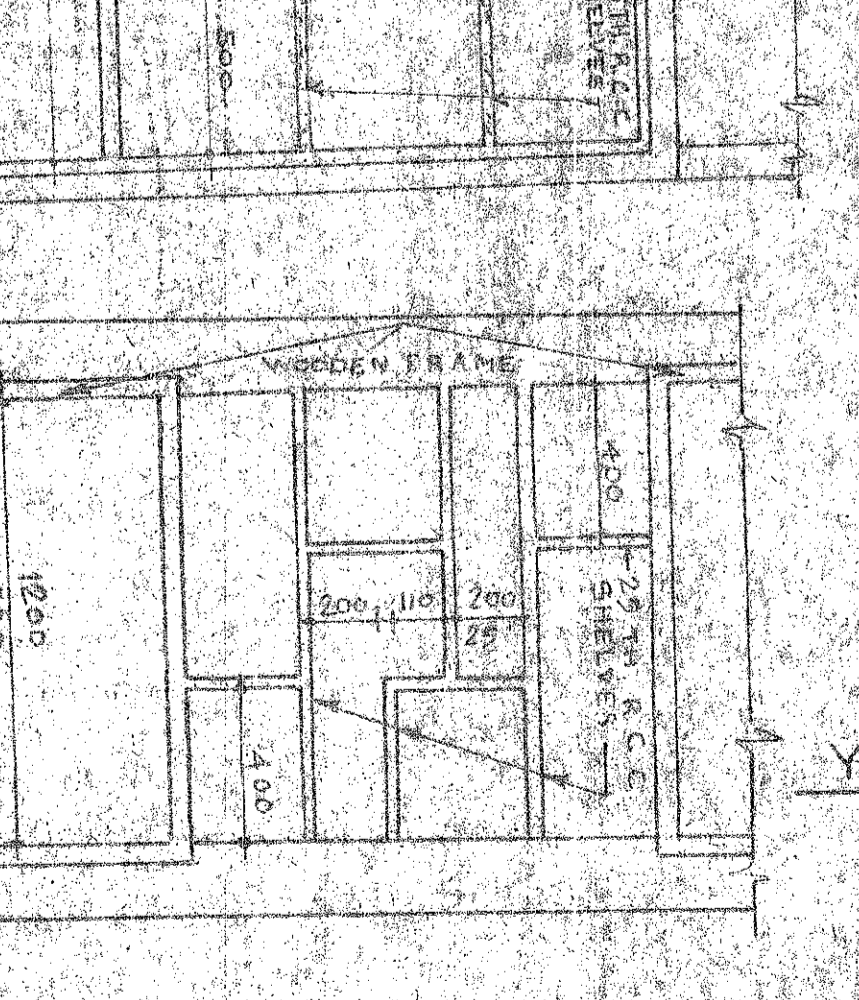
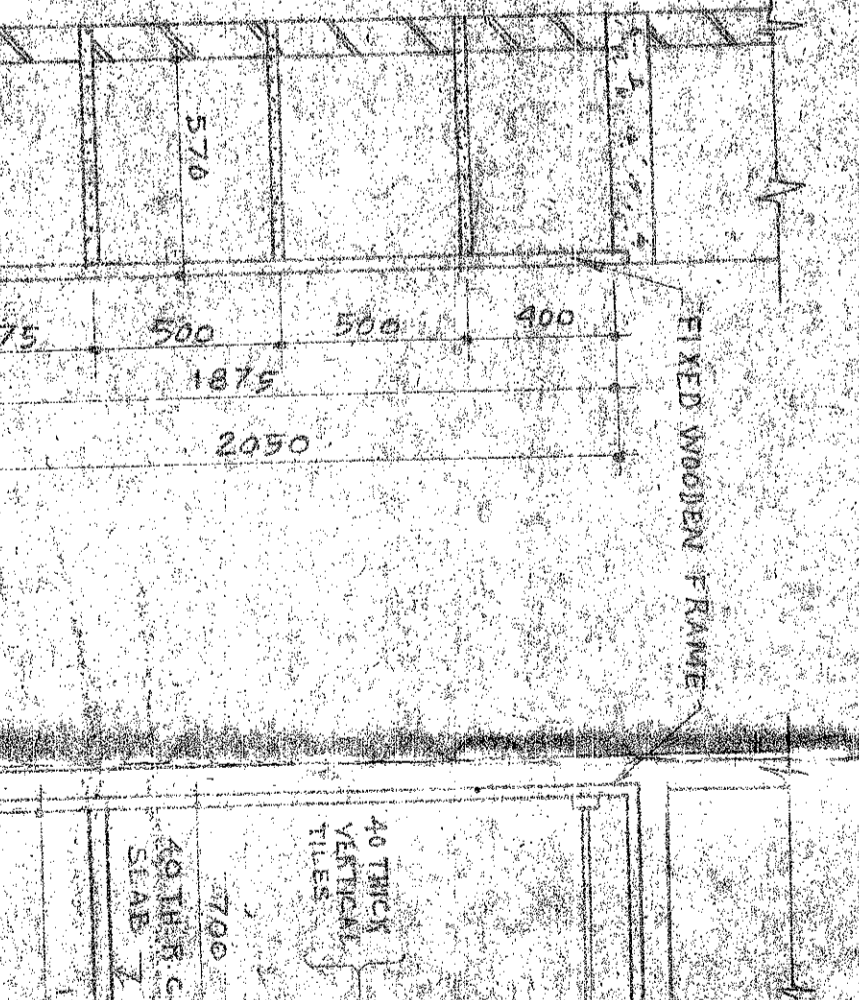

FRONT ELEVATION

GROUND FLOOR PLAN

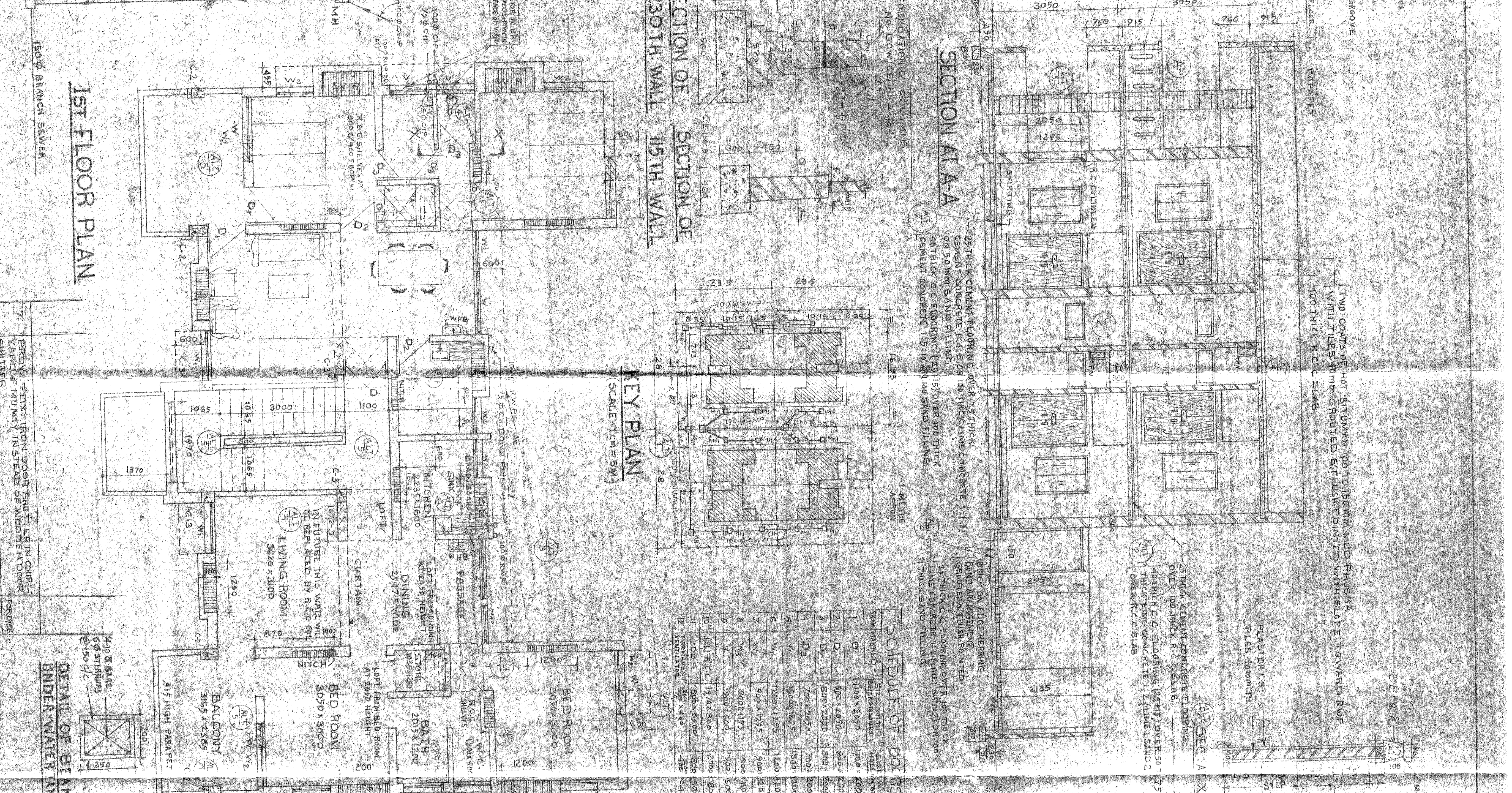

1ST FLOOR PLAN

SECTION OF 230TH WALL SECTION OF 15TH WALL

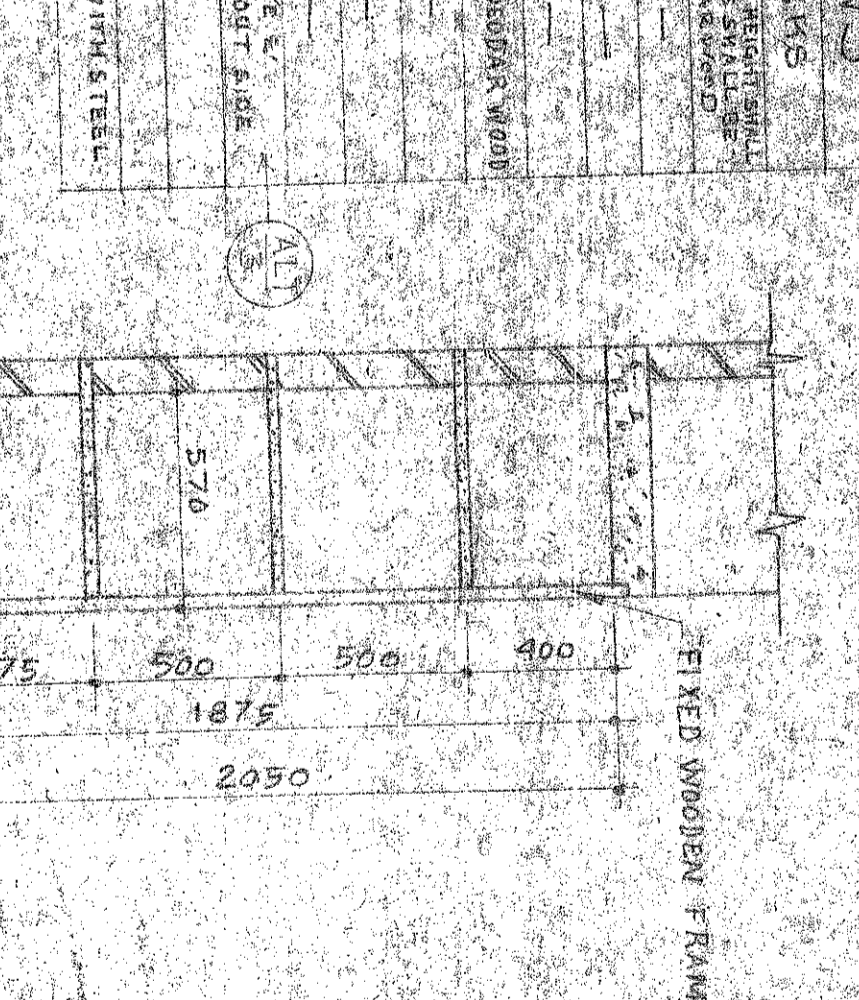
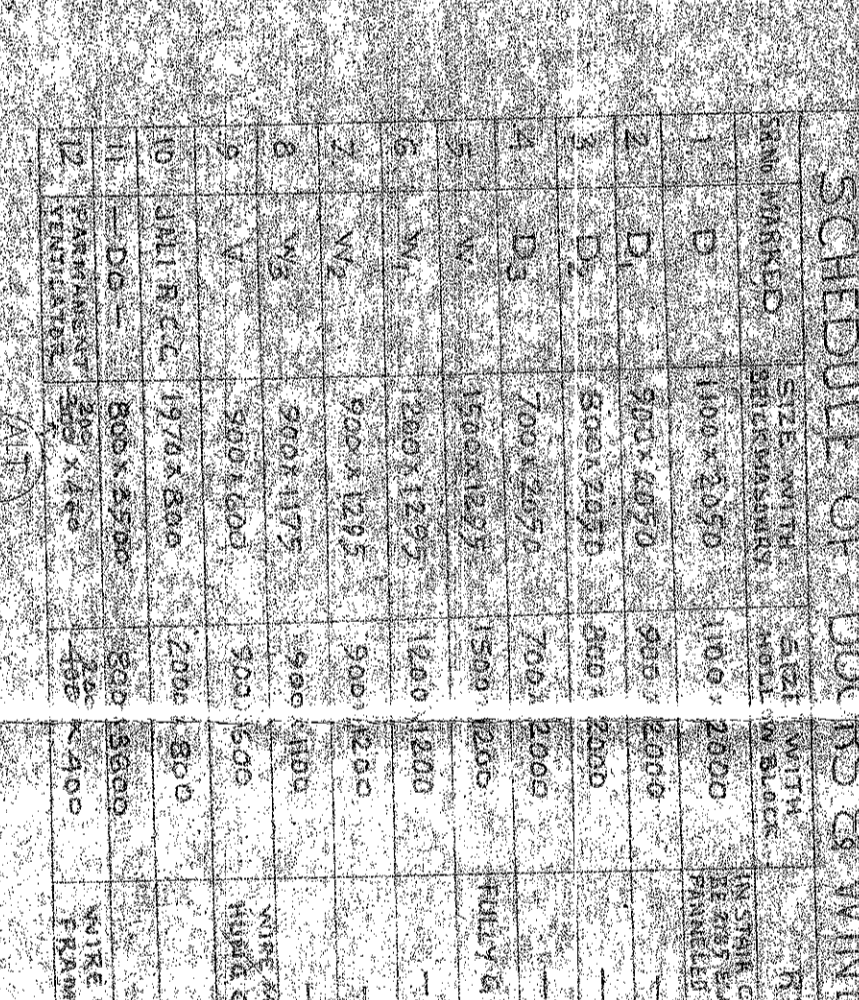
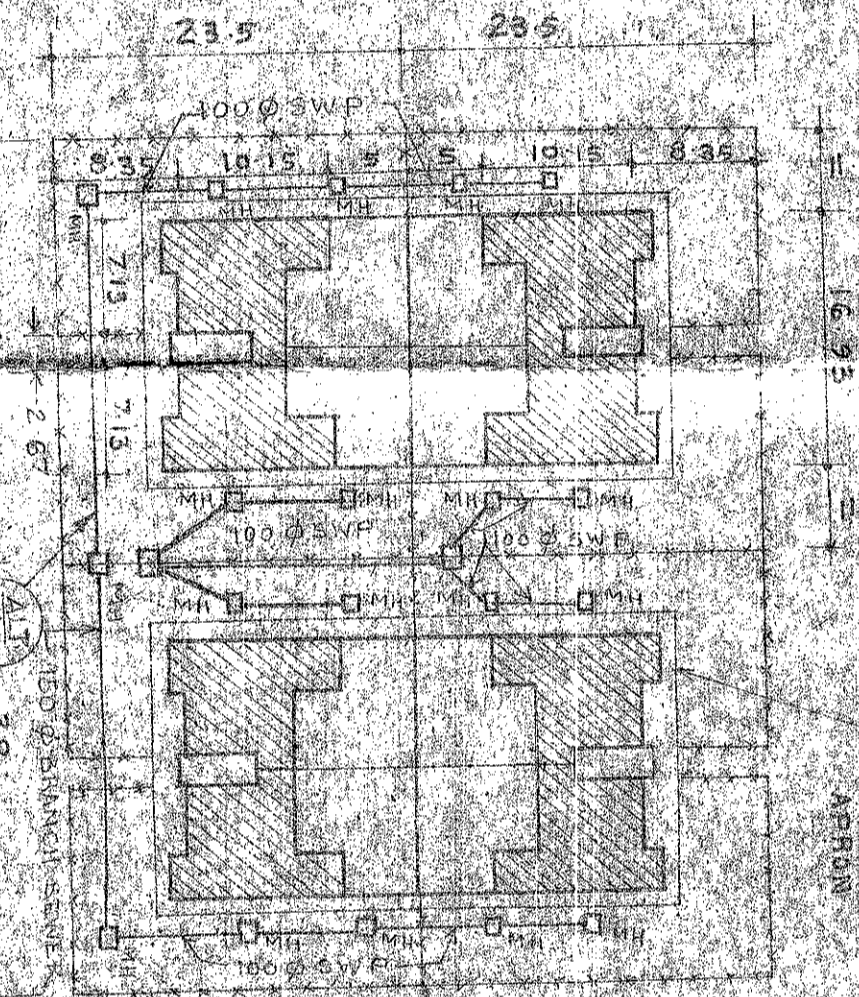

**DETAIL OF NITCH**

1. ALL DIMENSIONS ARE IN METERS UNLESS OTHERWISE SPECIFIED.

2. FINISHES ARE AS SHOWN IN THE FINISH SCHEDULE.

3. ALL WORK IS TO BE DONE IN ACCORDANCE WITH THE SPECIFICATIONS AND STANDARDS OF THE GOVERNMENT OF INDIA.

4. THE CONTRACTOR SHALL BE RESPONSIBLE FOR OBTAINING ALL NECESSARY PERMITS AND APPROVALS FROM THE LOCAL AUTHORITIES.

5. THE CONTRACTOR SHALL BE RESPONSIBLE FOR THE PROTECTION OF ALL EXISTING UTILITIES AND STRUCTURES.

6. THE CONTRACTOR SHALL BE RESPONSIBLE FOR THE PROTECTION OF ALL EXISTING TREES AND LANDSCAPE.

7. THE CONTRACTOR SHALL BE RESPONSIBLE FOR THE PROTECTION OF ALL EXISTING SERVICES.

8. THE CONTRACTOR SHALL BE RESPONSIBLE FOR THE PROTECTION OF ALL EXISTING STRUCTURES.

9. THE CONTRACTOR SHALL BE RESPONSIBLE FOR THE PROTECTION OF ALL EXISTING UTILITIES.

10. THE CONTRACTOR SHALL BE RESPONSIBLE FOR THE PROTECTION OF ALL EXISTING SERVICES.

DYCE/CI/UMB PLAN NO: P-389/DYCE/CI/UMB/12

**NORTHERN RAILWAY SH-N-1**

PROVISION OF ADDITIONAL ROOM, PANEL ROOM, RELAY ROOM, IPS ROOM, BATTERY ROOM AND SWITCH ROOM ADJACENT TO EXISTING S&T BUILDING AT LALRU RAILWAY STATION IN CONNECTION WITH AMBALA - DHAPPAR DOUBLING ON UMB-KLK SECTION.

PLAN, ELEVATION, SECTION AND FOOTING DETAIL

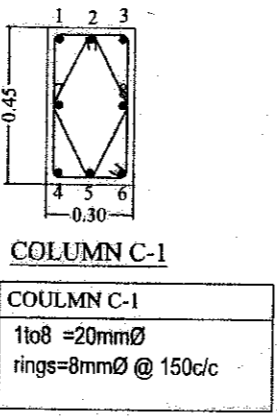
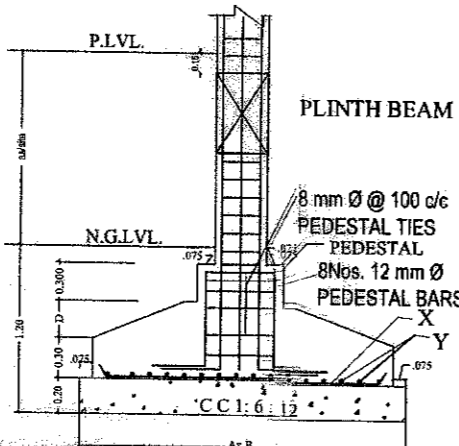
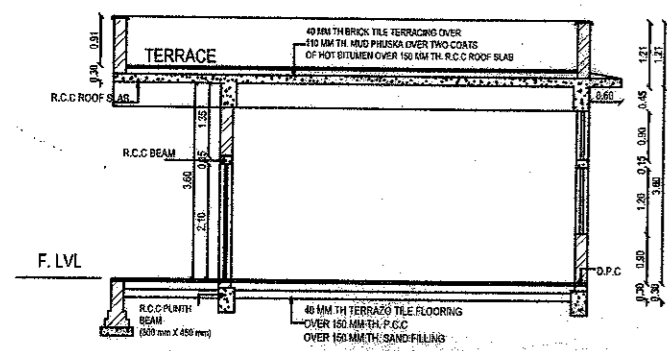
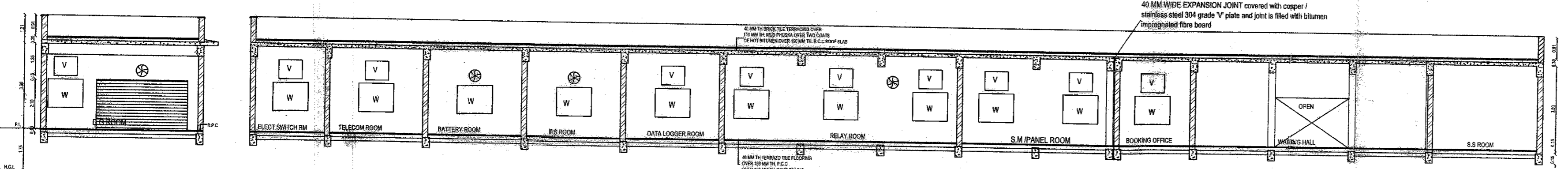
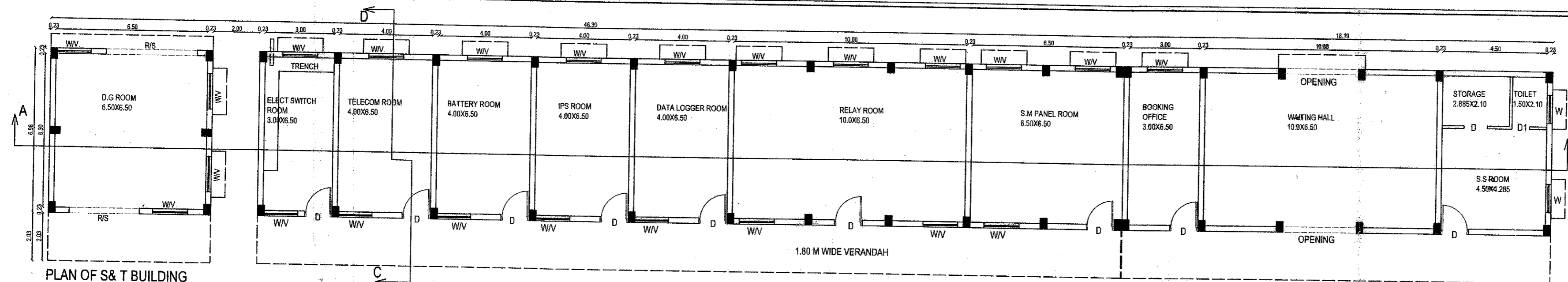

S.NO	FOOTING	SIZE OF FOOTING AxB	D	STEEL IN FOOTING
1	F-1	2.80 X 2.80	0.20	10mmØ @100c/c B/W X- 12mmØ @100c/c
2	F-2	3.00X 3.40	0.30	Y- 10mmØ @100c/c
3	F-3	2.00 X 2.00	0.20	10mmØ @125c/c B/W
4	F-4	1.90 X 1.90	0.20	10mmØ @150c/c B/W

JOINERY SCHEDULE				
S.NO.	NAME	SIZE	CILL	LINTEL
1.	D	1.20X2.10	±0	+2.10
2.	D1	0.75X2.10	±0	+2.10
3.	W	1.50X1.20	+0.90	+2.10
4.	V	1.00X0.90	+2.25	+3.15

REVISION:-

- NOTES:
- FOR CENTRAL LINE DIMENSIONS REFER GRID PLAN / ARCHITECTURAL DRAWINGS.
  - LEAN CONCRETE SHALL BE OF STONE BALLAST AND RATIO FOR THE SAME SHALL BE 1:5:10.
  - ALL CONCRETE MIX CONFORMING TO IS 456 (LATEST REVISION) SHALL BE USED IN R.C.C. WORK (UNLESS SPECIFIED OTHERWISE).
  - HIGH STRENGTH REINFORCED TMT REINFORCING STEEL BARS CONFORMING TO IS 1786 (LATEST REVISION) SHALL BE USED FOR REINFORCEMENT. THE HIGH YIELD STRENGTH SHALL NOT BE LESS THAN 500 N/mm<sup>2</sup>.
  - THE LAPS IN THE REINFORCING BARS SHALL BE STAGGERED, AND SHALL BE AVOIDED NEAR MID SPAN. THE LAP LENGTH SHALL NOT BE LESS THAN 47 TIMES DIA. OF BAR.
  - CLEAR COVERS
  - (A) FOUNDATION - 50 mm (B) BEAMS - 50 mm (C) SLAB - 20 mm
  - (D) COILS - 40 mm
  - IN CASE BARS OF SPECIFIED DIAMETER ARE NOT AVAILABLE, USE EQUIVALENT PERIMETER IF BARS OF SMALLER DIAMETER ARE USED. APPROVED STRUCTURAL ENGINEERS MAY BE CONSULTED FOR SUCH CHANGES.
  - THE LOCATION OF CONSTRUCTION JOINTS SHALL BE DECIDED AS PER RELEVANT STANDARD.
  - THE REINFORCEMENT SHALL REST ON FIRM SOIL. IN CASE ANY LOOSE POCKET IS ENCOUNTERED, THE STRUCTURAL ENGINEERS SHALL BE CONSULTED. EXCAVATED SURFACE HOWEVER SHALL BE WITH REINFORCED CONCRETE PRIOR TO LAYING OF CONCRETE.
  - THE NET COMPRESSIVE CAPACITY OF SOIL HAS BEEN TAKEN AS 1.1 T/m<sup>2</sup>.
  - THE STRUCTURAL DESIGN IS FOR G+H FLOORS.

DRAWING NO. 1

CONSULTANT:-

**CREATIONS**  
ARCHITECTS - PLANNERS - INTERIORS DESIGNER  
502, 2ND FLOOR, SHANMUKH WAKA, LERU, PANCHGOLA,  
PIN-8151-10575, 815275-76506, P.O. 8152, 8151197, 4057147

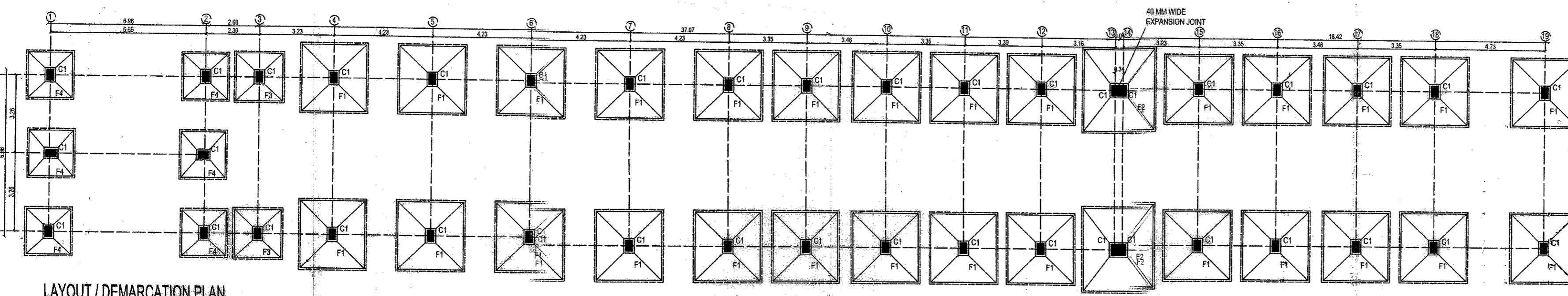

25.11.12  
SSE/WO/UMB

# PART-II

## TENDER FORMS

<b><u>FORM No.</u></b>	<b><u>SUBJECT</u></b>
Form No.1	Offer Letter
Form No.2	Tenderer's Credentials
Form No. 2 A	Technical eligibility criteria
Form No. 2 B	Financial eligibility criteria
Form No. 2 C	Applicants Party Information Form
Form No.3	Deleted
Form No.4	Summary of Quantities, Items & Rates (to be submitted with Financial Bid)
Form No.5	Bill of Quantities (to be submitted with Financial Bid)
Form No.6	Deleted
Form No.7	Deleted
Form No.8	Deleted
Form No.9	Deleted
Form No.10	Contract Agreement
Form No.11	Performance Guarantee Bond
Form No.12	Standing indemnity bond for on account payment.
Form No.13	Deleted
Form No.14	Deleted
Form No.15	Deleted
Form No.16	Electronic clearing service
Form No.17	Draft MOU for Joint Venture Participation
Form No.18	Draft Agreement for JV
Form No.19	Pro-forma of Participation from each partner of JV
Form No.21	Power of Attorney for authorized signatory of JV Partners
Form No.22	Power of Attorney to lead partner of JV

**OFFER LETTER**

Tender No. ....

Name of work .....

**To  
The Chief Project Manager,  
DFCCIL,  
Ambala.**

We, the undersigned, declare that:

- (a) We have examined and have no reservations to the Bidding Documents, including Addenda.;
- (b) We offer to execute the Works in conformity with the Bidding Documents;
- (c) Our bid shall be valid for a period of . . . . . days from the date fixed for the bid submission deadline in accordance with the Bidding Documents, and it shall remain binding upon us and may be accepted at any time before the expiration of that period;
- (d) We have not been blacklisted/banned in accordance with para 1.1.12 (ii)(c)(v)(b).of Preamble and General Instructions to Tenderers.
- (e) We are neither Bankrupt/Insolvent nor is in the process of winding-up nor there is a case of insolvency pending before any court on deadline of submission of the Bid in accordance with para. 1.1.12(ii)(c)(v)(a)of Preamble and General Instructions to Tenderers)
- (f) If our bid is accepted, we commit to obtain a Performance Guarantee in accordance with the Bidding Documents;
- (g) If our bid is accepted, we commit to deploy key equipment and key personnel consistent with the requirements of the work.
- (h) We understand that this bid, together with your written acceptance thereof included in your notification of award/Letter of Acceptance (LOA), shall constitute a binding contract between us, until a formal contract is prepared and executed; and
- (i) All information, statements and description in this bid are in all respect true, correct and complete to the best of our knowledge and belief and we have not made any tampering or changes in the bidding documents on which the bid is being submitted and if any tampering or changes/incorrect information are detected at any stage, we understand the bid will invite summary rejection and forfeiture of bid security, the contract will be liable to be terminated along with forfeiture of performance security, even if LOA has been issued.

- (j) We understand that you are not bound to accept the lowest bid or any other bid that you may receive.

Name .....  
In the capacity of .....  
Signed .....  
Duly authorized to sign the Bid for and on behalf of .....  
Date .....



**TENDERER'S CREDENTIALS**

<b>S.No</b>	<b>Description</b>
1.	For technical eligibility criteria, give details of similar completed works during the last three financial years (i.e current Financial year and three previous Financial Years in the proforma given in Form-2A
2.	For financial eligibility criteria, give details of contractual payments received for the last three financial years (i.e current Financial year and three previous financial years) as per audited balance sheet certified by Chartered Accountant in the proforma given in Form-2B
3.	Give constitution of your firm. Attach certified copies of legal documents in support thereof. Form-2C

**FORM-2A****Technical Eligibility Criteria Details****DETAILS OF THE SIMILAR WORKS COMPLETED (as per Para 1.1.12(i)A of Preamble and General Instructions to Tenderers)**

<b>Similar Contract No.</b>		
Contract Identification		
Award date		
Completion date		
Role in Contract	Prime Contractor <input type="checkbox"/>	Member in JV/Partnership firm <input type="checkbox"/>
Total Contract Amount (Rs.)		
If member in a JV/Partnership Firm , specify participation in total Contract amount	<i>[insert a percentage amount]</i>	<i>Total contract amount in Rs.</i>
Employer's Name: Address:  Telephone/fax number  E-mail:		
<b>Description of the similarity in accordance with Criteria 1.1.12(i)(A)</b>		

**The bidder shall attach copies of relevant Certificate of Completion issued by the Employer.**

Signature of the  
Tenderer with Seal

### Financial Eligibility Criteria Details

**Each Bidder or each member of JV/ Partnership firm must fill in this form separately.**

**Name of Bidder/JV Partner/ Individual partner of Partnership firm**

Details of contractual payments(Construction only) received during the last three financial years and current financial year

Contractual payments received(Construction only)	
Year	Value of payment received in Rs. (Contract Receipts)
Current Year(2014-2015)	
2013-2014	
2012-2013	
2011-2012	
Total Contractual Payment	

**Note:** The details should be extracted from the audited balance sheet Certified by the Chartered Accountant or form 16-A issued by the Employer.

**Signature of the Tenderer with Seal**

**Applicant's Party Information Form**

Applicant name: <i>[insert full name]</i>
Applicant's Party name: <i>[insert full name of Applicant's Party]</i>
Applicant's Party country of registration: <i>[indicate country of registration]</i>
Applicant Party's year of constitution: <i>[indicate year of constitution]</i>
Applicant Party's legal address in country of constitution: <i>[insert street/ number/ town or city/ country]</i>
Applicant Party's authorized representative information Name: <i>[insert full name]</i> Address: <i>[insert street/ number/ town or city/ country]</i> Telephone/Fax numbers: <i>[insert telephone/fax numbers, including country and city codes]</i> E-mail address: <i>[indicate e-mail address]</i>
1. Attached are copies of original documents of <input type="checkbox"/> Articles of Incorporation (or equivalent documents of constitution or association), and/or registration documents of the legal entity named above.

**Signature of the  
Tenderer with Seal**

**SUMMARY OF QUANTITIES, ITEMS & RATES**

**Attached separately in Financial bid (Packet B)**

DFCC /UMB

UTILITY SHIFTING-HR

---

**FORM-5**  
**Schedule of Quantities based on Unified Standard Schedule of Rate-2010,**  
**Electrical SOR & NS Items .**

**Attached separately in Financial Bid (Packet B)**

---

Bidders Signature

For DFCCIL

Page 118

DFCC /UMB

UTILITY SHIFTING-HR

---

**FORM - 7**

-DELETED-

---

Bidders Signature

For DFCCIL

Page 119

DFCC /UMB

UTILITY SHIFTING-HR

---

**FORM -8**

**Deleted**



DFCC /UMB

UTILITY SHIFTING-HR

---

**FORM-9**

**-Deleted-**

---

Bidders Signature

For DFCCIL

Page 121

**DRAFT AGREEMENT**

**CONTRACT AGREEMENT**

THIS AGREEMENT (“Agreement”) is made at Ambala on the \_\_\_\_\_ day of \_\_\_\_\_, \_\_\_\_\_,

BETWEEN

(1) Dedicated Freight Corridor Corporation of India Limited, incorporated under the laws of India and having its principal place of business at 5<sup>th</sup> Floor, Pragati Maidan Metro Station Building Complex, New Delhi, India – 110001 (hereinafter called ‘**the Employer**’), and \_\_\_\_\_, a company/corporation/JV incorporated under the laws of \_\_\_\_\_having its principal place of business at \_\_\_\_\_ (hereinafter called “**the Contractor**”).

WHEREAS in reference to a call for Tender for Construction of Service and residential buildings for Shifting of Utilities in connection with providing encumbrance-free land between Kalanaur to Ambala City in the jurisdiction of CPM/ ambala as per Tender paper No CPM/UMB/UTILITY- SHIFTING/HR-02 at Annexure “A” hereto, the Contractor has submitted a Tender hereto and whereas the said Tender of the contractor has been accepted for Construction of Service and residential buildings for Shifting of Utilities in connection with providing encumbrance-free land between Kalanaur to Ambala City in the jurisdiction of CPM/ ambala as per copy of the Letter of Acceptance of Tender No----- dated\_\_\_\_ complete with enclosure at the accepted rates and at an estimated contract value of Rs.\_\_(Rupees \_only). Now the agreement with witnesseth to that in consideration of the premises and the payment to be made by the Employer to the Contractor provided for herein below the Contractor shall supply all equipments and materials and execute and perform all works for which the said Tender of the Contractor has been accepted, strictly according to the various provisions in Annexure ‘A’ and ‘B’ hereto and upon such supply, execution and performance to the satisfaction of the Employer, the Employer shall pay to the contractor at the several rates accepted as per the said Annexure ‘B’ and in terms of the provisions therein.

IN WITNESS WHEREOF the parties hereto have caused their respective Common Seals to be hereunto affixed/ (or have hereunto set their respective hands and seals) the day and year first above written.

For and on behalf of the Contractor

For and on behalf of the Employer

Signature of the authorized official  
Name of the official

Signature of the authorized official  
Name of the official

Stamp/seal of the Contractor

Stamp/Seal of the Employer

**SIGNED, SEALED AND DELIVERED**

By the said \_\_\_\_\_ Name

\_\_\_\_\_ on behalf of the Contractor in the presence of:

Witness \_\_\_\_\_

Name \_\_\_\_\_

Address \_\_\_\_\_

By the said \_\_\_\_\_ Name

\_\_\_\_\_ on behalf of the Employer in the presence of:

Witness \_\_\_\_\_

Name \_\_\_\_\_

Address \_\_\_\_\_

Enclosures:-

1. Annexure 'A' - Tender Papers No.
2. Annexure 'B' - Letter of Acceptance of Tender No. \_\_\_\_\_ Dated \_\_\_\_\_ along with Summary of Prices

**Draft Proforma for Performance Guarantee****Name of the Bank** \_\_\_\_\_

Managing Director/ DFCCIL \_\_\_\_\_ Bank Guarantee Bond No. \_\_\_\_\_  
 Acting through \_\_\_\_\_ (Designation \_\_\_\_\_ Dated \_\_\_\_\_  
 and address of contract signing authority)

**PERFORMANCE GUARANTEE**

In consideration of the Managing Director/ DFCCIL acting through \_\_\_\_\_  
 (Designation & Address of Contract Signing Authority), Dedicated Freight Corridor  
 Corporation of India Limited, Ambala (hereinafter called "DFCCIL") having agreed  
 under the terms and conditions of agreement/Contract Acceptance letter No. \_\_\_\_\_  
 Dated \_\_\_\_\_  
 made between \_\_\_\_\_ (Designation & address of contract signing Authority) and  
 \_\_\_\_\_ (hereinafter called "the said contractor(s)" for the  
 work \_\_\_\_\_

\_\_\_\_\_ (hereinafter called "the said agreement") having agreed for submission of a irrevocable  
 Bank Guarantee for Rs. \_\_\_\_\_ (Rs.  
 \_\_\_\_\_ only) as a performance security Guarantee  
 from the contractor(s) for compliance of his obligations in accordance with the terms &  
 conditions in the said agreement.

1. We \_\_\_\_\_ (indicate the name of the Bank) hereinafter referred to as the  
 Bank, undertake to pay to the DFCCIL an amount not exceeding Rs. \_\_\_\_\_ (Rs.  
 \_\_\_\_\_ only) on demand by the DFCCIL
2. We \_\_\_\_\_ (indicate the name of the bank, further agree that (and promise) to  
 pay the amounts due and payable under this guarantee without any demur merely on a  
 demand from the DFCCIL through \_\_\_\_\_ (Designation & Address of  
 contract signing authority) DFCCIL, stating that the amount claimed is due by way of  
 loss or damage caused to or would be caused or suffered by the DFCCIL by reason of  
 any breach by the said contractor of any of the terms or conditions contained in the said  
 agreement or by reason of the contractor failure to perform the said agreement. Any  
 such demand made on the Bank shall be conclusive as regards the amount due and  
 payable by the Bank under this guarantee. However, our liability under this guarantee  
 shall be restricted to an amount not exceeding Rs. \_\_\_\_\_ (Rs. \_\_\_\_\_ only)
- 3 (a) We, \_\_\_\_\_ ( indicate the name of Bank ) further undertake to pay to the  
 DFCCIL any money so demanded notwithstanding any dispute or dispute raised by the  
 contractor (s) in any suit or proceeding pending before any court or Tribunal relating to  
 liability under this present being absolute and unequivocal.

- (b) The payment so made by us under this bond shall be valid discharge of our liability for payment there under and the contractor(s) shall have no claim against us for making such payment.
4. We, \_\_\_\_\_ (indicate the name of bank ) to further agree that the guarantee herein contained shall remain in full force and effect during the period that would be taken for the performance of the said agreement and that it shall continue to be enforceable till all the dues of the DFCCIL under or by virtue of the said agreement have been fully paid and its claims satisfied or discharged by \_\_\_\_\_ (Designation & Address of contract signing authority) on behalf of the DFCCIL, certify that the terms and conditions of the said agreement have been fully and properly carried out by the said contractor (s) and accordingly discharges this guarantee.
5. (a) Notwithstanding any thing to the contrary contained herein the liability of the bank under this guarantee will remain in force and effect until such time as this guarantee is discharged in writing by the DFCCIL or until ( date of validity/extended validity) which ever is earlier and no claim shall be valid under this guarantee unless notice in writing thereof is given by the DFCCIL within validity / extended period of validity of guarantee from the date aforesaid.  
(b) Provided always that we \_\_\_\_\_ (indicate the name of the Bank ) unconditionally undertakes to renew this guarantee to extend the period of guarantee form year to year before the expiry of the period or the extended period of the guarantee, as the case may be on being called upon to do so by the DFCCIL. If the guarantee is not renewed or the period extended on demand, we \_\_\_\_\_ (indicate the name of the Bank) shall pay the DFCCIL the full amount guarantee on demand and without demur.
6. We, \_\_\_\_\_ (indicate the name of Bank) further agree with the DFCCIL that the DFCCIL shall have the fullest liberty without our consent and without effecting in any manner out of obligations hereunder to vary any of the terms and conditions of the said contract from time to time or to postpone for any time or from time to time any to the powers exercisable by the DFCCIL against the said contractor (s) and to forbear or enforce any of the terms and conditions of the said agreement and we shall not be relieved from our liability by reason of any such variation, or extension being granted to the said contractor (s) or for any bearance act or omission on the part of the DFCCIL or any indulgence by the DFCCIL to the said contractor (s) or by any such matter or thing whatsoever which under the law relating to sureties for the said reservation would relive us from the liability.
7. This guarantee will not be discharged by any change in the constitution of the Bank or the Contractor (s).
8. We, \_\_\_\_\_ (indicate the name of the Bank) lastly undertake not to revoke this guarantee except with the previous consent of the DFCCIL in writing.
9. This guarantee shall be valid upto \_\_\_\_\_ (Date of completion plus 60 days beyond that). Unless extended on demand by DFCCIL. Notwithstanding anything to the contrary contained herein before, our liability under this guarantee is restricted to Rs. \_\_\_\_\_ (Rs. \_\_\_\_\_ only) unless a demand under this guarantee is made on us in writing on or before \_\_\_\_\_ we, shall be discharged from our liabilities under this guarantee thereafter.
-

DFCC /UMB

UTILITY SHIFTING-HR

---

Dated \_\_\_\_\_ the \_\_\_\_\_ day of \_\_\_\_\_ for  
\_\_\_\_\_ (indicate the name of bank)

Signature of Bank Authorize official  
(Name):  
Designation:  
Full Address.

Witness:

1. \_\_\_\_\_

2. \_\_\_\_\_

**Form-16**

**Electronic Clearing Service (Credit Clearing)**

Mandate Form

(Investor/customer's option to receive payments through Credit Clearing Mechanism)

Name of the Scheme and the periodicity of payment

- 1) Investor/customer's name
- 2) Particulars of Bank account

- A Name of the Bank
- B Name of the branch

Address

Telephone No.

- C 9-Ddigit-code number of the bank and branch appearing on the MICR cheque issued by the bank.
- D Type of the account (S.B/. Current or Cash Credit) with code (10/11/13)
- E Ledger and Ledger folio number.
- F Account number (as appearing on the cheque book)

(In lieu of the bank certificate to be obtained as under, please attach a blank cancelled cheque or photo copy of a cheque or front page of your savings bank passbook issued by your bank for verification of the above particulars)

3. Date of effect:

I hereby declare that the particulars given above are correct and complete. If the transaction is delayed or not effected at all for reasons of incomplete or incorrect information, I would not hold the user institution responsible. I have read the option invitation letter and agree to discharge the responsibility expected of me as a participant under the scheme.

(\_\_\_\_\_)

Signature of the Investor/Customer

Date

Certified that the particulars furnished above are correct as per our records  
Bank's Stamp.

**DRAFT MEMORANDUM OF UNDERSTANDING (MOU) For  
JOINT VENTURE PARTICIPATION  
BETWEEN**

M/s ..... having its registered office at ..... (hereinafter referred to as ..... ) acting as the Lead Partner of the first part,

**and**

M/s .....having its registered office at ..... (hereinafter referred to as `.....') in the capacity of a Joint Partner of the other part.

**and**

M/s .....having its registered office at ..... (hereinafter referred to as `.....') in the capacity of a Joint Partner of the other part.

The expressions of ..... and ..... shall wherever the context admits, mean and include their respective legal representatives, successors-in-interest and assigns and shall collectively be referred to as “the Parties” and individually as “ the Party”

**WHEREAS:**

Dedicated Freight Corridor Corporation of India Limited(DFCCIL) [hereinafter referred to as “Client”] has invited bids for ... “[Insert name of work].....”

**NOW, THEREFORE, THE PARTIES AGREE AS FOLLOWS:**

1. The following documents shall be deemed to form and be read and construed as an integral part of this MOU.

- i) Notice for Bid, and
- ii) Bidding document
- iii) Any Addendum/Corrigendum issued by Dedicated Freight Corridor Corporation of India Limited
- iv) The bid submitted on our behalf jointly by the Lead Partner.

2. The `Parties' have studied the documents and have agreed to participate in submitting a `bid' jointly.

3. M/s .....shall be the lead member of the JV for all intents and purpose and shall represent the Joint Venture in its dealing with the Client. For the purpose of submission of bid proposals, the parties agree to nominate ..... as the leader duly authorized to sign and submit all documents and subsequent clarifications, if any, to the Client. However M/s ..... shall not submit any such proposals, clarifications or commitments before securing the written clearance of the other partner which shall be expeditiously given by M/s.....to M/s.....

4. The `Parties' have resolved that the distribution of responsibilities and their proportionate share in the Joint Venture is as under:

- (a) Lead Partner;
- (i) .....



- (ii) .....
  - (iii) .....
  - (b) Joint Venture Partner
- (i) .....
- (ii) .....
  - (iii) .....

[Similar details to be given for each partner]

**5. JOINT AND SEVERAL RESPONSIBILITY**

The Parties undertake that they shall be jointly and severally liable to the Client in the discharge of all the obligations and liabilities as per the contract with the Client and for the performance of contract awarded to their JV.

**6. ASSIGNMENT AND THIRD PARTIES**

The parties shall co-operate throughout the entire period of this MOU on the basis of exclusivity and neither of the Parties shall make arrangement or enter into agreement either directly or indirectly with any other party or group of parties on matters relating to the Project except with prior written consent of the other party.

**7. EXECUTIVE AUTHORITY**

The said Joint Venture through its authorized representative shall receive instructions, payments from the Client. The management structure for the project shall be prepared by mutual consultations to enable completion of project to quality requirements within permitted cost and time.

**8. BID SECURITIES**

Till the award of the work, JV firm/Lead Partner of JV firm shall furnish Bid Security to the Client on behalf of the joint venture which shall be legally binding on all the members of the Joint Venture.

**9. BID SUBMISSION**

Each Party shall bear its own cost and expenses for preparation and submission of the bid and all costs until conclusion of a contract with the Client for the Project. Common expenses shall be shared by all the parties in the ratio of their actual participation.

**10. INDEMNITY**

Each party hereto agrees to indemnify the other party against its respective parts in case of breach/default of the respective party of the contract works of any liabilities sustained by the Joint Venture.

11. For the execution of the respective portions of works, the parties shall make their own arrangements to bring the required finance, plants and equipment, materials, manpower and other resources.

**12. DOCUMENTS & CONFIDENTIALITY**

Each Party shall maintain in confidence and not use for any purpose related to the Project all commercial and technical information received or generated in the course of preparation and submission of the bid.

**13. ARBITRATION**

Any dispute, controversy or claim arising out of or relating to this agreement shall be settled in the first instance amicably between the parties. If an amicable settlement cannot be reached as above, it will be settled by arbitration in accordance with the Indian Arbitration and Conciliation Act 1996 or any amendments thereof. The venue of the arbitration shall be as jointly decided with employer.

**14. VALIDITY**

This Agreement shall remain in force till the occurrence of the earliest to occur of the following, unless by mutual consent, the Parties agree in writing to extend the validity for a further period.

- a. The bid submitted by the Joint Venture is declared unsuccessful, or
- b. Cancellation/ shelving of the Project by the client for any reasons prior to award of work
- c. Execution of detailed JV agreement by the parties, setting out detailed terms after award of work by the Client.

15. This MOU is drawn in ..... number of copies with equal legal strength and status. One copy is held by M/s ..... and the other by M/s.....& .....M/s ..... and a copy submitted with the proposal.

16. This MOU shall be construed under the laws of India.

**17. NOTICES**

Notices shall be given in writing by fax confirmed by registered mail or commercial courier to the following fax numbers and addresses:

Lead Partner

.....

(Name & Address)

Other Partner(s)

.....

(Name & Address)

IN WITNESS WHEREOF THE PARTIES, have executed this MOU the day, month and year first before written.

M/s.....

.....

(Seal)

M/s.....

.....

(Seal)

Witness

1.....(Name & Address)

2..... (Name & Address)

**Notes:** (1) In case of existing joint venture, the certified copy of JV Agreement may be furnished.

**DRAFT FORMAT OF JOINT VENTURE AGREEMENT**

To be executed on non-judicial stamp paper of appropriate value in accordance with relevant Stamp Act and to be registered with appropriate authority under Registration Act.

The JV agreement shall be structured generally as per contents list given below:

**A. CONDITIONS AND TERMS OF JV AGREEMENT**

1. Definitions and Interpretation
2. Joint Venture – Include Equity of members, transferability of shareholding of equity of a partner leaving during the subsistence of the contract.
3. Proposal Submission
4. Performance – To indicate scope of responsibility of each member
5. Language and Law
6. Exclusively
7. Executive Authority
8. Documents
9. Personnel
10. Assignment and Third Parties
11. Severability
12. Member in Default
13. Duration of the Agreement
14. Liability and sharing of risks
15. Insurance
16. Sharing of Promotion and Project Costs, Profits, Losses and Remuneration
17. Financial Administration and Accounting
18. Guarantees and Bonds
19. Arbitration
20. Notices
21. Sole Agreement and Variation

**B. SCHEDULES**

1. Project and Agreement Particulars
2. Financial Administration Services
3. Allocation of the obligations
4. Financial Policy and Remuneration

\*\*\*\*\*

**PRO-FORMA LETTER OF PARTICIPATION FROM EACH PARTNER OF JOINT VENTURE (JV)**

(To be executed on non-judicial stamp paper of appropriate value in accordance with relevant Stamp Act and to be registered with appropriate authority under Registration Act.)

No....

Dated

From:

.....  
.....

To,  
Chief Project Manager,  
**Dedicated Freight Corridor Corporation of India Limited**  
Old Railway Colony, Near Anand Market.,  
Ambala Cantt. 133001  
Gentlemen,

Re: ...“*[Insert name of work]*.....”.

Ref: Your notice for Invitation for Tender (NIT) No. **CPM/UMB/UTILITY- SHIFTING/HR-02**dated .....

- 1. We wish to confirm that our company/firm has formed a Joint Venture with(i)..... & ii)..... for the purposes associated with NIT referred to above.

*(Members who are not the lead partner of the JV should add the following paragraph)*  
  
'The JV is led by ... whom we hereby authorise to act on our behalf for the purpose submission of Bid for ..... and authorise to incur liabilities and receive instructions for and on behalf of any and all the partners or constituents of the Joint Venture.'

OR

*(Member(s) being the lead member of the group should add the following paragraph)*  
  
'In this group we act as leader and, for the purposes of applying for Bid, represent Joint Venture:'

**3.** In the event of our JV being awarded the contract, we agree to be jointly with i) & ii) ..... (names of other members of our JV) and severally liable to the Dedicated Freight Corridor Corporation of India Limited, its successors and assigns for all obligations, duties and responsibilities arising from or imposed by the contract subsequently entered into between Dedicated Freight Corridor Corporation of India Limited and our JV.

Yours faithfully,

(Signature)

(Name of Signatory).....

(Capacity of Signatory).....

**Company Seal** \* Delete as applicable

Note : In case of existing joint venture, the certified copy of JV Agreement may be furnished.

**FORMAT FOR POWER OF ATTORNEY FOR AUTHORISED SIGNATORY OF JOINT VENTURE (JV) PARTNERS**

**POWER OF ATTORNEY\***

***(To be executed on non-judicial stamp paper of the appropriate value in accordance with relevant stamp Act. The stamp paper to be in the name of the company who is issuing the power of Attorney)***

Know all men by these presents, we ... do hereby constitute, appoint and authorise Mr/Ms. .... who is presently employed with us and holding the position of .....as our attorney, to do in our name and on our behalf, all such acts, deeds and things necessary in connection with or incidental to our bid for the work of ...Including signing and submission of all documents and providing information/responses to Dedicated Freight Corridor Corporation of India Limited, representing us in all matters, dealing with Dedicated Freight Corridor Corporation of India Limited in all matters in connection with our bid for the said project.

We hereby agree to ratify all acts, deeds and things lawfully done by our said attorney pursuant to this Power of Attorney and that all acts, deeds and things done by our aforesaid attorney shall and shall always be deemed to have been done by us.

Dated this the ..... day of ..... 200..

**(Signature of authorised Signatory)**

**Signature of Lead Partner**

**Signature of JV Partner(s)**

.....  
**(Signature and Name in Block letters of Signatory)**  
**Seal of Company**

Witness

Witness 1:

Name:

Address:

Occupation:

Witness 2:

Name:

Address:

Occupation:

*\*Notes:*

- i) To be executed by all the partners jointly, in case of a Joint Venture.

**FORMAT FOR POWER OF ATTORNEY TO  
LEAD PARTNER OF JOINT VENTURE (JV)**

***(To be executed on non-judicial stamp paper of the appropriate value in accordance with relevant stamp Act. The stamp paper to be in the name of the company who is issuing the power of Attorney)***

**POWER OF ATTORNEY\***

Whereas Dedicated Freight Corridor Corporation of India Limited has invited Bids for the work of “ **Construction of Service and residential buildings for Shifting of Utilities in connection with providing encumbrance-free land between Kalanaur to Ambala City in the jurisdiction of CPM/ Ambala.**”

Whereas, the members of the Joint Venture comprising of M/s. ..., M/s. ..., M/s. ...., and M/s. .... are interested in submission of bid for the work of ...*[Insert name of work]*... in accordance with the terms and conditions contained in the bidding documents.

Whereas, it is necessary for the members of the Joint Venture to designate one of them as the Lead Partner, with all necessary power and authority to do, for and on behalf of the Joint Venture, all acts, deeds and things as may be necessary in connection with the Joint Venture's bid for the project, as may be necessary in connection the Joint Venture's bid for the project.

NOW THIS POWER OF ATTORNEY WITNESSETH THAT:

We, M/s. ...., hereby designate M/s. ...., being one of the partners of the Joint Venture, as the lead partner of the Joint Venture, to do on behalf of the Joint Venture, all or any of the acts, deeds or things necessary or incidental to the Joint Venture's bid for the contract, including submission of bid, participating in conferences, responding to queries, submission of information/ documents and generally to represent the Joint Venture in all its dealings with the Railway or any other Government Agency or any person, in connection with the Bid/contract for the said work until culmination of the process of bidding till the contract agreement if successful, is entered into with the Dedicated Freight Corridor Corporation of India Limited and thereafter till the expiry of the contract agreement.

*\*To be executed by all the members of the JV except the lead member.*

*The mode of execution of the Power of Attorney should be in accordance with the procedure, if any, laid down by the applicable law and the charter documents of the executant(s) and when it is so required the same should be under common seal affixed in accordance with the required procedure.*

DFCC /UMB

UTILITY SHIFTING-HR

---

We hereby agree to ratify all acts, deeds and things lawfully done by lead member, our said attorney, pursuant to this power of attorney and that all acts deeds and things done by our aforesaid attorney shall and shall always be deemed to have been done by us/ Joint Venture.

Dated this the ..... Day of ..... 200

.....  
(Signature)

.....  
(Name in Block letters of Executants)  
Seal of Company

Witness 1: Name: Address: Occupation:	Witness 2: Name: Address: Occupation:
--	--